

UNITED STATES
SECURITIES AND EXCHANGE COMMISSION
Washington, D.C. 20549

Amendment No. 4 to
Form S-4
REGISTRATION STATEMENT
UNDER
THE SECURITIES ACT OF 1933

CLEANTECH ACQUISITION CORP.

(Exact name of registrant as specified in its charter)

Delaware	6770
(State or other jurisdiction of incorporation or organization)	(Primary Standard Industrial Classification Code Number)

207 West 25th Street, 9th Floor
New York, NY 10001
(212) 494-9005

(Address, including zip code, and telephone number, including area code, of registrant's principal executive offices)

Eli Spiro
Chairman and Chief Executive Officer
CleanTech Acquisition Corp.
207 West 25th Floor, 9th Floor
New York, NY 10001
(212) 494-9005

(Name, address, including zip code, and telephone number, including area code, of agent for service)

Copies to:

Mitchell S. Nussbaum Giovanni Caruso Jane Tam Loeb & Loeb LLP 345 Park Avenue New York, NY 10154 Telephone: (212) 407-4000	Michael Blankenship Douglas C. Lionberger Winston & Strawn LLP 800 Capitol Street, Suite 2400 Houston, TX 77002-2925 Telephone: (713) 651-2600
---	---

Approximate date of commencement of proposed sale to the public: As soon as practicable after the effective date of this registration statement and the satisfaction or waiver of all other conditions under the Merger Agreement described herein.

If the securities being registered on this Form are being offered in connection with the formation of a holding company and there is compliance with General Instruction G, check the following box:

If this Form is filed to register additional securities for an offering pursuant to Rule 462(b) under the Securities Act, check the following box and list the Securities Act registration statement number of the earlier effective registration statement for the same offering:

If this Form is a post-effective amendment filed pursuant to Rule 462(d) under the Securities Act, check the following box and list the Securities Act registration statement number of the earlier effective registration statement for the same offering:

Indicate by check mark whether the registrant is a large accelerated filer, an accelerated filer, a non-accelerated filer, smaller reporting company, or an emerging growth company. See the definitions of "large accelerated filer," "accelerated filer," "smaller reporting company," and "emerging growth company" in Rule 12b-2 of the Exchange Act.

Large accelerated filer	<input type="checkbox"/>	Accelerated filer	<input type="checkbox"/>
Non-accelerated filer	<input checked="" type="checkbox"/>	Smaller reporting company	<input checked="" type="checkbox"/>
		Emerging growth company	<input checked="" type="checkbox"/>

If an emerging growth company, indicate by check mark if the registrant has elected not to use the extended transition period for complying with any new or revised financial accounting standards provided pursuant to Section 7(a)(2)(B) of the Securities Act.

If applicable, place an X in the box to designate the appropriate rule provision relied upon in conducting this transaction:

Exchange Act Rule 13e-4 (i) (Cross-Border Issuer Tender Offer)	<input type="checkbox"/>
Exchange Act Rule 14d-1 (d) (Cross-Border Third-Party Tender Offer)	<input type="checkbox"/>

The Registrant hereby amends this registration statement on such date or dates as may be necessary to delay its effective date until the Registrant shall file a further amendment which specifically states that this registration statement shall thereafter become effective in accordance with Section 8(a) of the Securities Act of 1933, as amended, or until the registration statement shall become effective on such date as the Securities and Exchange Commission, acting pursuant to said Section 8(a), may determine.

[Table of Contents](#)

The information in this proxy statement/prospectus is not complete and may be changed. These securities may not be sold until the registration statement filed with the Securities and Exchange Commission is effective. This proxy statement/prospectus is not an offer to sell and it is not soliciting an offer to buy these securities in any jurisdiction where the offer or sale is not permitted.

**PRELIMINARY PROXY STATEMENT/PROSPECTUS SUBJECT TO COMPLETION, DATED
JUNE 16, 2022**

PROPOSED MERGER

YOUR VOTE IS VERY IMPORTANT

Dear Stockholders:

You are cordially invited to attend the special meeting of the stockholders (the “Meeting”) of CleanTech Acquisition Corp. (“CleanTech” or “CLAQ”), which will be held at _____ a.m./p.m., Eastern time, on _____, 2022. The Board of Directors has determined to convene and conduct the Meeting in a virtual meeting format at _____. Stockholders will NOT be able to attend the Meeting in-person. This proxy statement/prospectus includes instructions on how to access the virtual Meeting and how to listen, vote, and submit questions from home or any remote location with internet connectivity.

CleanTech is a Delaware blank check company established for the purpose of entering into a merger, share exchange, asset acquisition, stock purchase, recapitalization, reorganization or other similar business transaction with one or more businesses or entities, which we refer to as a “target business.” Holders of CleanTech’s Common Stock, will be asked to approve, among other things, the Merger Agreement, dated as of December 16, 2021, as amended on January 30 and June 6, 2022 (the “Merger Agreement”), by and among CleanTech, CleanTech Merger Sub, Inc., a Texas corporation and wholly -owned subsidiary of CleanTech (“Merger Sub”) and Nauticus Robotics, Inc. (formerly known as “Houston Mechatronics, Inc.”), a Texas corporation (“Nauticus” or “Nauticus Robotics”), and the other related Proposals.

Upon the closing of the transactions contemplated in the Merger Agreement, Merger Sub will merge with and into Nauticus (the “Business Combination”) with Nauticus surviving the Merger as a wholly owned subsidiary of CleanTech. In addition, in connection with the consummation of the Merger, CleanTech will be renamed “Nauticus Robotics, Inc.” and the current Nauticus Robotics, Inc. will be renamed “Nauticus Robotics (Texas), Inc.” The transactions contemplated under the Merger Agreement relating to the Merger are referred to in this proxy statement/prospectus as the “Business Combination” and the combined company after the Business Combination is referred to in this proxy statement/prospectus as the “Combined Company.”

Pursuant to the Merger Agreement, as amended, the following actions will be taken, and the following consideration will be paid, in connection with the Business Combination:

Preferred Stock. Immediately prior to the Effective Time, each share of Nauticus Preferred Stock that is issued and outstanding immediately prior to such time shall automatically convert into shares of Nauticus Common stock, par value \$0.01 per share (the “Nauticus Common Stock”), in accordance with its Certificate of Incorporation (collectively, the “Nauticus Preferred Stock Conversion”). An aggregate of 15,062,524 shares of CLAQ Common Stock will be issued to the holders of Nauticus Preferred Stock.

Convertible Notes. Immediately prior to the Effective Time, each of (i) that certain Unsecured Convertible Promissory Note, dated June 19, 2021, by and between Goradia Capital, LLC and Nauticus, as amended on December 16, 2021, (ii) that certain Unsecured Convertible Promissory Note, August 3, 2021, by and between Material Impact Fund II, L.P. and Nauticus, as amended on December 16, 2021, (iii) that certain Unsecured Convertible Promissory Note, dated October 22, 2021, by and between In-Q-Tel, Inc. and Nauticus, as amended on December 16, 2021, (iv) that certain Unsecured Convertible Promissory Note, dated July 28, 2020, by and between Schlumberger Technology Corporation and Nauticus, as amended on December 16, 2021, and (v) that certain Unsecured Convertible Promissory Note, dated December 7, 2020, by and between Transocean Inc. and Nauticus, as amended on December 16, 2021 (each, a “Nauticus Convertible Note” and collectively, the “Nauticus Convertible Notes”) shall automatically convert into shares of Nauticus Common Stock in accordance with the terms of each such Nauticus Convertible Note (collectively, the “Nauticus Convertible Notes Conversion”). An aggregate of 5,299,543 shares of CLAQ Common Stock will be issued to the holders of Nauticus Convertible Notes.

Common Stock. At the Effective Time, following the Nauticus Preferred Stock Conversion and Nauticus Convertible Notes Conversion, each share of Nauticus Common Stock (including shares of Nauticus Common Stock outstanding as a result of the Nauticus Preferred Stock Conversion and Nauticus Convertible Notes Conversion, but excluding shares of the holders of which perfect rights of appraisal under Delaware law) will be converted into the right

[Table of Contents](#)

to receive the Per Share Merger Consideration of 14.2069 (as defined below) shares of CLAQ Common Stock and the Earnout Shares (as defined below). An aggregate of 9,669,216 shares of CLAQ Common Stock will be issued to the holders of Nauticus Common Stock.

Stock Options. At the Effective Time, each outstanding option to purchase shares of Nauticus Common Stock (a “Nauticus Option”), whether or not then vested and exercisable, will be assumed by CLAQ and converted automatically (and without any required action on the part of such holder of outstanding option) into an option to purchase shares of the CLAQ’s Common Stock equal to the number of shares determined by multiplying the number of shares of the Nauticus Common Stock subject to such Nauticus Option immediately prior to the Effective Time by the Exchange Ratio of 14.2069 (as defined below), which product shall be rounded down to the nearest whole number of shares, at a per share exercise price determined by dividing the per share exercise price of such Nauticus Option immediately prior to the Effective Time by the Exchange Ratio. Options to purchase an aggregate of 3,977,368 shares of CLAQ Common Stock will be issued to the holders of Nauticus Options.

Earnout Shares. Following the closing of the merger, former holders of shares of Nauticus Common Stock (including shares received as a result of the Nauticus Preferred Stock conversion and the Nauticus Convertible Notes conversion, the “Stockholder Earnout Group”) shall be entitled to receive their pro rata share of up to 7,500,000 additional shares of Combined Company Common Stock (the “Earnout Shares”). The Earnout Shares will be released and delivered to the Stockholder Earnout Group upon occurrence of the following (each, a “Triggering Event”):

- (i) one-half of the Escrow Shares will be released if, within a 5-year period following the signing date of the Merger Agreement, the volume-weighted average price of the Combined Company Common Stock equals or exceeds \$15.00 per share over any 20 trading days within a 30-day trading period;
- (ii) one-quarter of the Escrow Shares will be released if, within a 5-year period following the signing date of the Merger Agreement, the volume-weighted average price of the Combined Company Common Stock equals or exceeds \$17.50 per share over any 20 trading days within a 30-day trading period; and
- (iii) one-quarter of the Escrow Shares will be released if, within a 5-year period following the signing date of the Merger Agreement, the volume-weighted average price of the Combined Company Common Stock equals or exceeds \$20.00 per share over any 20 trading days within a 30-day trading period.

On or about December 14, 2021, CLAQ entered into subscription agreements, with certain investors pursuant to which, among other things, CLAQ agreed to issue and sell, in a private placement to close immediately prior to the closing of the Business Combination, an aggregate of 3,530,000 shares of our common stock for \$10.00 per share for a total of \$35.3 million (the “Equity Financing”). On December 16, 2021, CLAQ entered into a Securities Purchase Agreement with certain investors purchasing up to an aggregate of \$40.0 million in principal amount of secured debentures (the “Debentures”) and warrants substantially concurrently with the closing of the Business Combination. The number of shares of common stock into which the Debentures are convertible is equal to 120% of the outstanding principal amount of the Debentures divided by the conversion price of \$15.00, and the number of shares of common stock into which the associated warrants are exercisable is equal to 120% of the outstanding principal amount of the Debentures divided by the conversion price, with an exercise price equal to \$20, subject to adjustment (the “Debt Financing,” and together with the Equity Financing, the “PIPE Investment”). There will be an original issue discount of 2% from the issued amount of the Debentures. Interest will accrue on all outstanding principal amount of the Debentures at 5% per annum, payable quarterly. The Debentures will be secured by first priority interests, and liens on, all present and after-acquired assets of the Combined Company, and will mature on the fourth anniversary of the date of issuance. As of the date of this proxy statement/prospectus, ATW Special Situations I LLC (“ATW”) is the only purchaser and has subscribed for Debentures in the an aggregate principal amount of \$37,959,184 which is convertible into 3,036,735 shares of the Combined Company’s common stock and associated warrants for an additional 3,036,735 shares of the Combined Company’s common stock. ATW is managed by ATW Partners Opportunities Management, LLC, which is an affiliate of Chardan Capital Markets, LLC (“Chardan”), and our director, Mr. Jonas Grossman, is the Managing Partner and President of Chardan. Chardan will not receive any fees or compensation for ATW’s participation in the Debt Financing.

The obligations to close the Debt Financing are conditioned upon, among other things, (i) raising \$25,000,000 in equity financing from strategic investors, (ii) hiring a chief financial officer with public company experience, and (iii) all conditions precedent to the Merger set forth in the Merger Agreement having been satisfied or waived. The Equity Financing will satisfy the closing condition related to the equity financing requirement for the Debt

[Table of Contents](#)

Financing, and the PIPE Investment alone will satisfy the Minimum Cash Condition under the Merger Agreement. Mr. Rangan Padmanabhan, Nauticus' current CFO will be the CFO of the Company effective as of the date of the merger, satisfying the closing condition related to the hiring of a CFO with public company experience requirement for the Debt Financing.

It is anticipated that upon completion of the Business Combination and assuming no redemptions by CLAQ public stockholders, CLAQ's public stockholders (other than the Equity Financing investors) would retain an ownership interest of approximately 28.5% in the Combined Company, the Equity Financing investors will own approximately 5.6% of the Combined Company (such that the public stockholders, including the Equity Financing investors, would own approximately 34.1% of the Combined Company), the Co-Sponsors, officers, directors and other holders of founder shares will retain an ownership interest of approximately 6.8% of the Combined Company and the Nauticus stockholders will own approximately 59.1% (including the 7,500,000 Earnout Shares) of the Combined Company. The ownership percentage with respect to the Combined Company does not take into account (i) the redemption of any shares by the CLAQ public stockholders, (ii) the issuance of any additional shares upon the closing of the Business Combination under the 2015 Equity Incentive Plan, or (iii) the issuance of the Debentures and associated warrants in connection with the Debt Financing. If the actual facts are different from these assumptions (which they are likely to be), the percentage ownership retained by the CLAQ stockholders will be different. See "Unaudited Pro Forma Condensed Combined and Consolidated Financial Information."

As of May 16, 2022, there was approximately \$174.2 million in CLAQ's trust account (the "Trust Account"). On _____, 2022, the record date for the Meeting of stockholders, the last sale price of CLAQ's Common Stock was \$ _____ per share.

Each stockholder's vote is very important. Whether or not you plan to participate in the virtual Meeting, please submit your proxy card without delay. Stockholders may revoke proxies at any time before they are voted at the meeting. Voting by proxy will not prevent a stockholder from voting virtually at the Meeting if such stockholder subsequently chooses to participate in the Meeting.

We encourage you to read this proxy statement/prospectus carefully. In particular, you should review the matters discussed under the caption "Risk Factors" beginning on page 45.

CLAQ's board of directors recommends that CLAQ stockholders vote "FOR" approval of each of the Proposals.

Neither the Securities and Exchange Commission nor any state securities commission has approved or disapproved of the securities to be issued in the Business Combination or otherwise, or passed upon the adequacy or accuracy of this proxy statement. Any representation to the contrary is a criminal offense.

This proxy statement/prospectus is dated _____, 2022, and is first being mailed to stockholders of CLAQ and Nauticus on or about _____, 2022.

/s/ Eli Spiro

Eli Spiro

Chief Executive Officer

CleanTech Acquisition Corp.

_____, 2022

CLEANTECH ACQUISITION CORP.
207 West 25th Street, 9th Floor
New York, NY 10001
Telephone: (212) 494-9005

NOTICE OF SPECIAL MEETING OF
CLEANTECH ACQUISITION CORP. STOCKHOLDERS
To Be Held on , 2022

To CleanTech Acquisition Corp. Stockholders:

NOTICE IS HEREBY GIVEN, that you are cordially invited to attend a meeting of the stockholders of CleanTech Acquisition Corp. (“CLAQ,” “we”, “our”, or “us”), which will be held at a.m./p.m., Eastern time, on , 2022, at (the “Meeting”). In light of COVID-19 we will hold the Meeting virtually. You can participate in the virtual Meeting as described in “The Meeting.”

During the Meeting, CLAQ’s stockholders will be asked to consider and vote upon the following proposals, which we refer to herein as the “Proposals”:

1. To consider and vote upon a proposal to approve the transactions contemplated under the Merger Agreement, dated as of December 16, 2021, as amended on January 30 and June 6, 2022 (the “Merger Agreement”), by and among CleanTech, CleanTech Merger Sub, Inc., a Texas corporation and wholly-owned subsidiary of CleanTech (“Merger Sub”) and Nauticus Robotics, Inc., a Texas corporation (“Nauticus” or “Nauticus Robotics”), (the “Business Combination”), a copy of which is attached to this proxy statement/prospectus as *Annex A*. This Proposal is referred to as the “Business Combination Proposal” or “Proposal 1.”
 2. To consider and vote upon a proposal to approve the Second Amended and Restated Certificate of Incorporation of CleanTech, a copy of which is attached to this proxy statement/prospectus as *Annex B* (the “Amended Charter”) to, among other things, change CleanTech’s name to “Nauticus Robotics, Inc.,” to be effective upon the consummation of the Business Combination. This Proposal is referred to as the “Charter Approval Proposal” or “Proposal 2.”
 3. To consider and vote upon a proposal to approve the Amended and Restated Bylaws of CleanTech, a copy of which is attached to this proxy statement/prospectus as *Annex C* (the “Amended Bylaws”) to, among other things, to be effective upon the consummation of the Business Combination. This Proposal is referred to as the “Bylaws Proposal” or “Proposal 3.”
 4. To approve and adopt, on a non-binding advisory basis, certain differences, in the governance provisions set forth in the Amended Charter, as compared to our Current Charter, which are being presented in accordance with the requirements of the U.S. Securities and Exchange Commission (the “SEC”) as five (5) separate sub-proposals. These Proposals are referred to as the “Governance Proposals” or “Proposals 4A-4E.”
 5. To consider and vote upon a proposal to elect, effective as of the consummation of the Business Combination, Nicolaus Radford, Eli Spiro, Mark Mey, Lisa Porter, Jim Bellingham, Adam Sharkawy, John W. Gibson Jr. and Joseph W. Dyer to serve on the Board until their respective successors are duly elected and qualified. This Proposal is referred to as the “Directors Proposal” or “Proposal 5.”
 6. To consider and vote upon a proposal to approve the Nauticus Robotics, Inc. 2022 Incentive Award Plan (the “Incentive Award Plan”), a copy of which is to be attached to this proxy statement/prospectus as *Annex D*, to be effective upon the consummation of the Business Combination. This Proposal is referred to as the “Stock Plan Proposal” or “Proposal 6.”
 7. To consider and vote upon a proposal to approve for purposes of complying with Nasdaq Listing Rule 5635(a) and (b), the issuance of more than 20% of the issued and outstanding shares of common stock and the resulting change in control in connection with the Merger. This Proposal is referred to as the “Nasdaq Merger Proposal” or “Proposal 7.”
-

[Table of Contents](#)

8. To consider and vote upon a proposal to approve for purposes of complying with Nasdaq Listing Rule 5635(d), the issuance or potential issuance of more than 20% of the common stock in connection with the PIPE Investment in connection with the Business Combination. This Proposal is referred to as the “Nasdaq PIPE Proposal” or “Proposal 8.”
9. To consider and vote upon a proposal to approve the adjournment of the Meeting by the chairman thereof to a later date, if necessary, under certain circumstances, including for the purpose of soliciting additional proxies in favor of the foregoing Proposals, in the event CleanTech does not receive the requisite stockholder vote to approve the Proposals. This Proposal is called the “Adjournment Proposal” or “Proposal 9.”

The Business Combination Proposal is conditioned upon the approval of Proposals 2, 3, 5, 6, 7 and 8. Proposals 2, 3, 4, 5, 6, 7 and 8 are dependent upon approval of the Business Combination Proposal. It is important for you to note that in the event that the Business Combination Proposal is not approved, CLAQ will not consummate the Business Combination. If CLAQ does not consummate the Business Combination and fails to complete an initial business combination by July 19, 2022, CLAQ will be required to dissolve and liquidate, unless we seek stockholder approval to amend our Certificate of Incorporation to extend the date by which the Business Combination may be consummated.

Approval of the Business Combination Proposal, the Bylaws Proposal, Governance Proposals, the Stock Plan Proposal, the Nasdaq Merger Proposal, the Nasdaq PIPE Proposal, and the Adjournment Proposal will each require the affirmative vote of the holders of a majority of the issued and outstanding shares of common stock present in person by virtual attendance or represented by proxy and entitled to vote at the Meeting or any adjournment thereof. Approval of the Charter Approval Proposal will require the affirmative vote of a majority of the issued and outstanding shares of common stock. Approval of the Directors Proposal will require the plurality of votes cast.

As of _____, 2022, there were 21,562,500 shares of common stock issued and outstanding and entitled to vote. Only CLAQ stockholders who hold common stock of record as of the close of business on _____, 2022 are entitled to vote at the Meeting or any adjournment of the Meeting. This proxy statement/prospectus is first being mailed to CLAQ stockholders on or about _____, 2022.

Investing in CLAQ’s securities involves a high degree of risk. See “Risk Factors” beginning on page 45 for a discussion of information that should be considered in connection with an investment in CLAQ’s securities.

YOUR VOTE IS VERY IMPORTANT. PLEASE VOTE YOUR SHARES PROMPTLY.

Whether or not you plan to participate in the virtual Meeting, please complete, date, sign and return the enclosed proxy card without delay, or submit your proxy through the internet or by telephone as promptly as possible in order to ensure your representation at the Meeting no later than the time appointed for the Meeting or adjourned meeting. Voting by proxy will not prevent you from voting your shares of common stock online if you subsequently choose to participate in the virtual Meeting. Please note, however, that if your shares are held of record by a broker, bank or other agent and you wish to vote at the Meeting, you must obtain a proxy issued in your name from that record. Only stockholders of record at the close of business on the record date may vote at the Meeting or any adjournment or postponement thereof. If you fail to return your proxy card or fail to instruct your bank, broker or other nominee how to vote, and do not participate in the virtual Meeting, your shares will not be counted for purposes of determining whether a quorum is present at, and the number of votes voted at, the Meeting.

You may revoke a proxy at any time before it is voted at the Meeting by executing and returning a proxy card dated later than the previous one, by participating in the virtual Meeting and casting your vote by hand or by ballot (as applicable) or by submitting a written revocation to Advantage Proxy, that is received by the proxy solicitor before we take the vote at the Meeting. If you hold your shares through a bank or brokerage firm, you should follow the instructions of your bank or brokerage firm regarding revocation of proxies.

CLAQ’s board of directors recommends that CLAQ stockholders vote “FOR” approval of each of the Proposals. When you consider CLAQ’s Board of Director’s recommendation of these Proposals, you should keep in mind that CLAQ’s directors and officers have interests in the Business Combination that may conflict or differ from your interests as a stockholder. See the section titled “Proposals to be Considered by CLAQ Stockholders: The Business Combination — Interests of CLAQ’s Directors, Officers and Certain Stockholders in the Business Combination.”

[Table of Contents](#)

On behalf of the CLAQ Board of Directors, I thank you for your support and we look forward to the successful consummation of the Business Combination.

By Order of the Board of Directors,

/s/ Eli Spiro

Eli Spiro

Chief Executive Officer

CleanTech Acquisition Corp.

, 2022

IF YOU RETURN YOUR PROXY CARD WITHOUT AN INDICATION OF HOW YOU WISH TO VOTE, YOUR SHARES WILL BE VOTED IN FAVOR OF EACH OF THE PROPOSALS.

TO EXERCISE YOUR REDEMPTION RIGHTS, YOU MUST (I) IF YOU: (A) HOLD PUBLIC COMMON STOCK, OR (B) HOLD PUBLIC COMMON STOCK THROUGH PUBLIC UNITS AND YOU ELECT TO SEPARATE YOUR PUBLIC UNITS INTO THE UNDERLYING PUBLIC COMMON STOCK PRIOR TO EXERCISING YOUR REDEMPTION RIGHTS WITH RESPECT TO THE PUBLIC COMMON STOCK; AND (II) PRIOR TO _____ A.M./P.M., EASTERN TIME, ON _____, 2022, (A) SUBMIT A WRITTEN REQUEST TO CONTINENTAL THAT CLAQ REDEEM YOUR PUBLIC COMMON STOCK FOR CASH AND (B) DELIVER YOUR PUBLIC COMMON STOCK TO CONTINENTAL, PHYSICALLY OR ELECTRONICALLY USING THE DEPOSITORY TRUST COMPANY'S DWAC (DEPOSIT WITHDRAWAL AT CUSTODIAN) SYSTEM, IN EACH CASE, IN ACCORDANCE WITH THE PROCEDURES DESCRIBED IN THE PROXY STATEMENT/PROSPECTUS. IF THE BUSINESS COMBINATION IS NOT CONSUMMATED, THEN THE PUBLIC SHARES WILL NOT BE REDEEMED FOR CASH. IF YOU HOLD THE SHARES IN STREET NAME, YOU WILL NEED TO INSTRUCT THE ACCOUNT EXECUTIVE AT YOUR BANK OR BROKER TO WITHDRAW THE SHARES FROM YOUR ACCOUNT IN ORDER TO EXERCISE YOUR REDEMPTION RIGHTS. SEE "THE MEETING — REDEMPTION RIGHTS" IN THIS PROXY STATEMENT/PROSPECTUS FOR MORE SPECIFIC INSTRUCTIONS.

HOW TO OBTAIN ADDITIONAL INFORMATION

This proxy statement/prospectus incorporates important business and financial information about CLAQ that is not included or delivered herewith. If you would like to receive additional information or if you want additional copies of this document, agreements contained in the appendices or any other documents filed by CLAQ with the Securities and Exchange Commission, such information is available without charge upon written or oral request. Please contact our proxy solicitor:

ADVANTAGE PROXY
P.O. Box 13581
Des Moines, WA 98198
Toll Free: (877) 870-8565
Collect: (206) 870-8565
Email: ksmith@advantageproxy.com

If you would like to request documents, please do so no later than _____, to receive them before the Meeting. Please be sure to include your complete name and address in your request. Please see “*Where You Can Find Additional Information*” to find out where you can find more information about CLAQ and Nauticus.

ABOUT THIS PROXY STATEMENT/PROSPECTUS

This document, which forms part of a registration statement on Form S-4 filed with the SEC by CLAQ, constitutes a prospectus of CLAQ under the Securities Act of 1933, as amended (the "Securities Act"), with respect to the shares of common stock of CLAQ to be issued to Nauticus' stockholders under the Merger Agreement. This document also constitutes a proxy statement of CLAQ under Section 14(a) of the Exchange Act.

You should rely only on the information contained in this proxy statement/prospectus in deciding how to vote on the Business Combination. Neither CLAQ nor Nauticus has authorized anyone to give any information or to make any representations other than those contained in this proxy statement. Do not rely upon any information or representations made outside of this proxy statement. The information contained in this proxy statement/prospectus may change after the date of this proxy statement. Do not assume after the date of this proxy statement/prospectus that the information contained in this proxy statement/prospectus is still correct.

Information contained in this proxy statement/prospectus regarding CLAQ and its business, operations, management and other matters has been provided by CLAQ and information contained in this proxy statement/prospectus regarding Nauticus and its business, operations, management and other matters has been provided by Nauticus.

This proxy statement/prospectus does not constitute an offer to sell or a solicitation of an offer to buy any securities, or the solicitation of a proxy or consent, in any jurisdiction to or from any person to whom it is unlawful to make any such offer or solicitation in such jurisdiction.

MARKET AND INDUSTRY DATA

Certain information contained in this document relates to or is based on studies, publications, surveys and other data obtained from third-party sources and CLAQ's and Nauticus' own internal estimates and research. While we believe these third-party sources to be reliable as of the date of this proxy statement/prospectus, we have not independently verified the market and industry data contained in this proxy statement/prospectus or the underlying assumptions relied on therein. Finally, while we believe our own internal research is reliable, such research has not been verified by any independent source.

TRADEMARKS

This document contains references to trademarks, trade names and service marks belonging to other entities. Solely for convenience, trademarks, trade names and service marks referred to in this proxy statement/prospectus may appear without the ® or TM symbols, but such references are not intended to indicate, in any way, that the applicable licensor will not assert, to the fullest extent under applicable law, its rights to these trademarks and trade names. We do not intend our use or display of other companies' trade names, trademarks or service marks to imply a relationship with, or endorsement or sponsorship of us by, any other companies.

TABLE OF CONTENTS

	PAGE
FREQUENTLY USED TERMS	1
CAUTIONARY NOTE REGARDING FORWARD-LOOKING STATEMENTS	4
QUESTIONS AND ANSWERS ABOUT THE PROPOSALS	6
SUMMARY OF THE PROXY STATEMENT/PROSPECTUS	21
SELECTED HISTORICAL FINANCIAL DATA OF CLAQ	42
SELECTED HISTORICAL FINANCIAL DATA OF NAUTICUS	43
TRADING MARKET AND DIVIDENDS	44
RISK FACTORS	45
THE MEETING	91
PROPOSAL 1 — THE BUSINESS COMBINATION PROPOSAL	95
PROPOSAL 2 — THE CHARTER APPROVAL PROPOSAL	130
PROPOSAL 3 — THE BYLAWS PROPOSAL	133
PROPOSALS 4A-4E — THE GOVERNANCE PROPOSALS	134
PROPOSAL 5 — THE DIRECTORS PROPOSAL	137
PROPOSAL 6 — THE STOCK PLAN PROPOSAL	139
PROPOSAL 7 — THE NASDAQ MERGER PROPOSAL	145
PROPOSAL 8 — THE NASDAQ PIPE PROPOSAL	147
PROPOSAL 9 — THE ADJOURNMENT PROPOSAL	149
MATERIAL U.S. FEDERAL INCOME TAX CONSEQUENCES	150
CLAQ'S BUSINESS	155
MANAGEMENT'S DISCUSSION AND ANALYSIS OF FINANCIAL CONDITION AND RESULTS OF OPERATIONS OF CLAQ	158
INFORMATION ABOUT NAUTICUS ROBOTICS, INC.	162
MANAGEMENT'S DISCUSSION AND ANALYSIS OF FINANCIAL CONDITION AND RESULTS OF OPERATIONS OF NAUTICUS	176
UNAUDITED PRO FORMA CONDENSED COMBINED AND CONSOLIDATED FINANCIAL INFORMATION	192
NOTES TO UNAUDITED PRO FORMA CONDENSED COMBINED AND CONSOLIDATED FINANCIAL INFORMATION	198
DESCRIPTION OF CLAQ'S SECURITIES	202
COMPARISON OF STOCKHOLDERS' RIGHTS	210
DIRECTORS AND EXECUTIVE OFFICERS OF CLAQ	221
DIRECTORS AND EXECUTIVE OFFICERS OF NAUTICUS	227
2021 SUMMARY COMPENSATION TABLE	229
OUTSTANDING EQUITY AWARDS AT 2020 FISCAL YEAR-END	231
DIRECTOR COMPENSATION	231
DIRECTORS AND EXECUTIVE OFFICERS OF THE COMBINED COMPANY AFTER THE BUSINESS COMBINATION	232
SECURITY OWNERSHIP OF CERTAIN BENEFICIAL OWNERS AND MANAGEMENT	238
CERTAIN RELATIONSHIPS AND RELATED TRANSACTIONS	241
LEGAL MATTERS	247
EXPERTS	247
APPRAISAL RIGHTS	247
DELIVERY OF DOCUMENTS TO STOCKHOLDERS	248
TRANSFER AGENT AND REGISTRAR	248
SUBMISSION OF STOCKHOLDER PROPOSALS	248
FUTURE STOCKHOLDER PROPOSALS	248
WHERE YOU CAN FIND MORE INFORMATION	249
INDEX TO FINANCIAL STATEMENTS	F-1

[Table of Contents](#)

	PAGE
ANNEX A — MERGER AGREEMENT	A-1
ANNEX B — FORM OF SECOND AMENDED AND RESTATED CERTIFICATE OF INCORPORATION	B-1
ANNEX C — AMENDED AND RESTATED BYLAWS	C-1
ANNEX D — NAUTICUS ROBOTICS, INC. 2022 INCENTIVE AWARD PLAN	D-1
ANNEX E — SECTION 262 APPRAISAL RIGHTS	E-1
ANNEX F — FAIRNESS OPINION	F-1

FREQUENTLY USED TERMS

Unless otherwise stated in this proxy statement, the terms, “we,” “us,” “our” “CleanTech” or “CLAQ” refer to CleanTech Acquisition Corp., a Delaware corporation. Further, in this document:

- “Amended Charter” means the Second Amended and Restated Certificate of Incorporation of CLAQ.
- “Board” means the board of directors of CLAQ.
- “Business Combination” means the merger contemplated by the Merger Agreement.
- “CLAQ Rights” or “Rights” means the rights as part of the Units sold by CLAQ in its IPO.
- “CLAQ Warrants” or “Warrants” means the redeemable warrants that entitle the holder thereof to purchase one share of common stock at a price of \$11.50 per share.
- “Certificate of Incorporation” or “Current Charter” means CLAQ’s current Amended and Restated Certificate of Incorporation.
- “Chardan” or “Chardan Capital Markets, LLC” means Chardan Capital Markets, LLC, the representative of the underwriters in CLAQ’s initial public offering.
- “CleanTech Investments” means CleanTech Investments, LLC, an entity affiliated with certain of CLAQ’s investors and Chardan.
- “CleanTech Sponsor” means CleanTech Sponsor I LLC, an entity affiliated with certain of CLAQ’s directors and officers.
- “Closing” means the consummation of the Business Combination.
- “Closing Date” means date of the consummation of the Business Combination.
- “Co-sponsors” means CleanTech Sponsor and CleanTech Investments.
- “Code” means the Internal Revenue Code of 1986, as amended.
- “Closing Share Price” means \$10.00 per share.
- “Combined Company” means CLAQ after the Business Combination, renamed “Nauticus Robotics, Inc.”
- “Combination Period” means the period of time from the closing of the IPO to consummate the initial Business Combination pursuant to CLAQ’s Current Charter.
- “common stock” means the shares of common stock, par value \$0.0001 per share, of CLAQ prior to the Closing, and the Common Stock of the Combined Company following the Closing.
- “Continental” means Continental Stock Transfer & Trust Company, CLAQ’s transfer agent.
- “Duff & Phelps” means Kroll LLC operating through its Duff & Phelps Opinions Practice.
- “Effective Time” means the time at which the Business Combination becomes effective.
- “Equity Value” means the sum of (i) Three Hundred Million (\$300,000,000) plus (ii) the amount by which (x) the outstanding liabilities and obligations of CLAQ with respect to the Transactions (including with respect to Indebtedness of CLAQ and Outstanding CLAQ Expenses) at the Closing (but prior to repayment thereof at the Closing) exceeds (y) \$35,000,000. For the avoidance of doubt, the amount described in sub-clause (ii) of this definition of Equity Value shall not be less than zero (0) and the Equity Value shall not be less than Three Hundred Million (\$300,000,000).
- “Exchange Act” means the Securities Exchange Act of 1934, as amended.
- “Exchange Ratio” means the ratio determined by dividing (a) the Per Share Merger Consideration Value, by (b) the Closing Share Price.

[Table of Contents](#)

- “founder shares” means an aggregate of 4,312,500 shares of common stock held by our cosponsors, directors and officers, consisting of (i) 2,595,000 shares of common stock held by CleanTech Investments; (ii) 1,437,500 shares of common stock held by CleanTech Sponsor; and (iii) an aggregate of 280,000 shares of common stock held by CLAQ officers, directors and certain advisors.
- “GAAP” means accounting principles generally accepted in the United States of America.
- “Incentive Award Plan” means the Nauticus Robotics, Inc. 2022 Incentive Award Plan.
- “Initial Stockholders” means the Co-sponsors and any other initial holders of CLAQ common stock and Private Warrants.
- “IPO” means the initial public offering of 15,000,000 Units of CLAQ consummated on July 19, 2021, including the additional 2,250,000 Units sold to cover the over-allotment option on July 28, 2021.
- “IRS” means the United States Internal Revenue Service.
- “Meeting” means the special meeting of the stockholders of CLAQ, which will be held at _____ a.m./p.m., Eastern time, on _____, 2022.
- “Merger Agreement” means that certain Merger Agreement, dated as of December 16, 2021, as amended on January 30 and June 6, 2022, by and among CLAQ, Merger Sub and Nauticus.
- “Merger Sub” means CleanTech Merger Sub, Inc., a Texas corporation and wholly-owned subsidiary of CLAQ.
- “Minimum Cash Condition” means the aggregate cash available to CLAQ at Closing from the Trust Account and the PIPE Investment (after giving effect to the redemption and the payment of all expenses) shall equal or exceed \$50,000,000.
- “Nauticus” or “Nauticus Robotics” means Nauticus Robotics, Inc., a Texas corporation, formerly known as Houston Mechatronics, Inc.
- “Nauticus Convertible Notes” means (i) that certain Unsecured Convertible Promissory Note, dated June 19, 2021, by and between Goradia Capital, LLC and Nauticus, as amended on December 16, 2021, (ii) that certain Unsecured Convertible Promissory Note, August 3, 2021, by and between Material Impact Fund II, L.P. and Nauticus, as amended on December 16, 2021, (iii) that certain Unsecured Convertible Promissory Note, dated October 22, 2021, by and between In-Q-Tel, Inc. and Nauticus, as amended on December 16, 2021, (iv) that certain Unsecured Convertible Promissory Note, dated July 28, 2020, by and between Schlumberger Technology Corporation and Nauticus, as amended on December 16, 2021, and (v) that certain Unsecured Convertible Promissory Note, dated December 7, 2020, by and between Transocean Inc. and Nauticus, as amended on December 16, 2021 (each, a “Nauticus Convertible Note” and collectively, the “Nauticus Convertible Notes”).
- “Per Share Merger Consideration” means with respect to any share of Nauticus Common Stock, issued and outstanding immediately prior to the Effective Time, including those issued in connection with the Nauticus Preferred Stock Conversion and the Nauticus Convertible Note Conversion, a number of shares of the Combined Company’s Common Stock equal to (i) the Per Share Merger Consideration Value *divided by* (ii) the Closing Share Price.
- “Per Share Merger Consideration Value” means \$142.069.
- “PIPE Investment” means the sale and issuance of (i) 3,530,000 shares of common stock to certain investors for an aggregate purchase price of \$35.3 million in a private placement immediately prior to the closing of the Business Combination (the “Equity Financing”); and (ii) up to an aggregate of \$40.0 million in principal amount of secured debentures (the “Debentures”) (of which we have entered into agreements for \$37,959,184 of Debentures) and warrants to certain investors named in the Securities Purchase Agreement dated December 16, 2021, substantially concurrently with the closing of the Business Combination (the “Debt Financing”).
- “public stockholders” means holders of Public Common Stock.

[Table of Contents](#)

- “Public Common Stock” means Common Stock sold in the IPO as part of the Units, whether they were purchased in the IPO or thereafter in the open market.
- “Public Warrants” means warrants sold in the IPO as part of the Units, whether they were purchased in the IPO or thereafter in the open market.
- “Private Warrants” mean the 7,175,000 Warrants issued to the Co-Sponsors, consisting of (i) 4,783,333 Private Warrants issued to CleanTech Sponsor; and (ii) 2,391,667 Private Warrants issued to CleanTech Investments, in a private placement in connection with the consummation of the IPO.
- “RaaS” means Robotics as a Service.
- “SEC” means the U.S. Securities and Exchange Commission.
- “Securities Act” means the Securities Act of 1933, as amended.
- “Trust Account” means CLAQ’s trust account maintained by Continental.
- “Units” means the units of CLAQ, each consisting of one share of common stock, one right and one-half of one redeemable warrant.

CAUTIONARY NOTE REGARDING FORWARD-LOOKING STATEMENTS

This proxy statement/prospectus contains forward-looking statements, including statements about the parties' ability to close the Business Combination, the anticipated benefits of the Business Combination, and the financial condition, results of operations, earnings outlook and prospects of CLAQ and/or Nauticus and may include statements for the period following the consummation of the Business Combination. Forward-looking statements appear in a number of places in this proxy statement/prospectus including, without limitation, in the sections titled "Management's Discussion and Analysis of Financial Condition and Results of Operations of Nauticus" and "Business of Nauticus." In addition, any statements that refer to projections, forecasts or other characterizations of future events or circumstances, including any underlying assumptions, are forward-looking statements. Forward-looking statements are typically identified by words such as "plan," "believe," "expect," "anticipate," "intend," "outlook," "estimate," "forecast," "project," "continue," "could," "may," "might," "possible," "potential," "predict," "should," "would" and other similar words and expressions, but the absence of these words does not mean that a statement is not forward-looking.

The forward-looking statements are based on the current expectations of the management of CLAQ and Nauticus as applicable and are inherently subject to uncertainties and changes in circumstances and their potential effects and speak only as of the date of such statement. There can be no assurance that future developments will be those that have been anticipated. These forward-looking statements involve a number of risks, uncertainties or other assumptions that may cause actual results or performance to be materially different from those expressed or implied by these forward-looking statements. These risks and uncertainties include, but are not limited to, those factors described in "Risk Factors," those discussed and identified in public filings made with the SEC by CLAQ and the following:

- the inability of the parties to successfully or timely consummate the Business Combination, including the risk that any required regulatory approvals are not obtained, are delayed or are subject to unanticipated conditions that could adversely affect Nauticus or the expected benefits of the Business Combination, if not obtained;
- the failure to realize the anticipated benefits of the Business Combination;
- matters discovered by the parties as they complete their respective due diligence investigation of the other parties;
- the ability of CLAQ prior to the Business Combination, and the Combined Company following the Business Combination, to maintain the listing of CLAQ's securities on Nasdaq;
- costs related to the Business Combination;
- the failure to satisfy the conditions to the consummation of the Business Combination, including the approval of the definitive merger agreement by the stockholders of CLAQ, the satisfaction of the minimum cash requirements of the definitive merger agreement following any redemptions by CLAQ's public stockholders;
- the risk that the Business Combination may not be completed by the stated deadline and the potential failure to obtain an extension of the stated deadline; the inability to complete a PIPE Investment;
- the outcome of any legal proceedings that may be instituted against CLAQ or Nauticus related to the Business Combination;
- the attraction and retention of qualified directors, officers, employees and key personnel of CLAQ and Nauticus prior to the Business Combination, and the Combined Company following the Business Combination;
- the ability of Nauticus to compete effectively in a highly competitive market;
- the ability to protect and enhance Nauticus' corporate reputation and brand;
- the impact from future regulatory, judicial, and legislative changes in Nauticus' industry;
- the uncertain effects of the COVID-19 pandemic;

[Table of Contents](#)

- competition from larger technology companies that have greater resources, technology, relationships and/or expertise;
- future financial performance of the Combined Company following the Business Combination including the ability of future revenues to meet projected annual bookings;
- the ability of Nauticus to forecast and maintain an adequate rate of revenue growth and appropriately plan its expenses;
- the ability of Nauticus to generate sufficient revenue from each of our revenue streams;
- the ability of Nauticus' patents and patent applications to protect Nauticus' core technologies from competitors;
- Nauticus' ability to manage a complex set of marketing relationships and realize projected revenues from subscriptions, advertisements;
- product sales and/or services;
- Nauticus' ability to execute its business plans and strategy; and
- those factors set forth in documents of CLAQ filed, or to be filed, with SEC.

Should one or more of these risks or uncertainties materialize or should any of the assumptions made by the management of CLAQ and Nauticus prove incorrect, actual results may vary in material respects from those projected in these forward-looking statements.

All subsequent written and oral forward-looking statements concerning the Business Combination or other matters addressed in this proxy statement/prospectus and attributable to CLAQ, Nauticus or any person acting on their behalf are expressly qualified in their entirety by the cautionary statements contained or referred to in this proxy statement/prospectus. Except to the extent required by applicable law or regulation, CLAQ and Nauticus undertake no obligation to update these forward-looking statements to reflect events or circumstances after the date of this proxy statement/prospectus or to reflect the occurrence of unanticipated events.

QUESTIONS AND ANSWERS ABOUT THE PROPOSALS

The following are answers to some questions that you, as a stockholder of CLAQ, may have regarding the Proposals being considered at the Meeting. We urge you to read carefully the remainder of this proxy statement/prospectus because the information in this section does not provide all the information that might be important to you with respect to the Proposals and the other matters being considered at the Meeting. Additional important information is also contained in the annexes to and the documents incorporated by reference into this proxy statement/prospectus.

Q: What is the purpose of this document?

A: CLAQ, Merger Sub, and Nauticus, have agreed to the Business Combination under the terms of the Merger Agreement, which is attached to this proxy statement/prospectus as *Annex A*, and is incorporated into this proxy statement/prospectus by reference. The Board is soliciting your proxy to vote for the Business Combination and other Proposals at the Meeting because you owned common stock at the close of business on _____, 2022, the “Record Date” for the Meeting, and are therefore entitled to vote at the Meeting. This proxy statement/prospectus summarizes the information that you need to know in order to cast your vote.

Q: What is being voted on?

A: Below are the Proposals that the CLAQ stockholders are being asked to vote on:

- Proposal 1 — The Business Combination Proposal to approve the Merger Agreement and the Business Combination.
- Proposal 2 — The Charter Approval Proposal to approve the Second Amended and Restated Certificate of Incorporation attached to this proxy statement/prospectus as *Annex B*.
- Proposal 3 — The Bylaws Proposal to approve the Amended and Restated Bylaws attached to this proxy statement/prospectus as *Annex C*.
- Proposals 4A-4E — The Governance Proposals to approve and adopt, on a non-binding advisory basis, certain differences, in the governance provisions set forth in the Amended Charter, as compared to our Current Charter.
- Proposal 5 — The Directors Proposal to elect, effective as of the consummation of the Business Combination, Nicolaus Radford, Eli Spiro, Mark Mey, Lisa Porter, Jim Bellingham, Adam Sharkawy, Joseph W. Dyer, and John W. Gibson, Jr. to serve on the Board until their respective successors are duly elected and qualified.
- Proposal 6 — The Stock Plan Proposal to approve the Incentive Award Plan.
- Proposal 7 — The Nasdaq Merger Proposal to approve the issuance of more than 20% of the issued and outstanding shares of common stock in connection with the terms of the Merger Agreement, which will result in a change of control, as required by Nasdaq Listing Rule 5635(a) and (b).
- Proposal 8 — The Nasdaq PIPE Proposal to approve the issuance or potential issuance of more than 20% of the issued and outstanding shares of common stock in connection with the PIPE Investment, as required by Nasdaq Listing Rule 5635(d).
- Proposal 9 — The Adjournment Proposal to approve the adjournment of the Meeting.

Q: What vote is required to approve the Proposals?

A: Proposal 1 — The Business Combination Proposal requires the affirmative vote of the majority of the issued and outstanding shares of common stock present by virtual attendance or represented by proxy and entitled to vote at the Meeting. An abstention will have the effect of a vote “AGAINST” Proposal 1. Broker non-votes will have no effect on the vote for Proposal 1.

Proposal 2 — The Charter Approval Proposal requires the affirmative vote of the majority of the issued and outstanding shares of common stock. Abstentions and broker non-votes will have the effect of a vote “AGAINST” Proposal 2.

[Table of Contents](#)

Proposal 3 — The Bylaws Proposal requires the affirmative vote of the majority of the issued and outstanding shares of common stock present in person by virtual attendance or represented by proxy and entitled to vote. An abstention will have the effect of a vote “AGAINST” Proposal 3. Broker non-votes will have no effect on the vote for Proposal 3.

Proposals 4A-4E — The Governance Proposals require the affirmative vote of the majority of the issued and outstanding shares of common stock present in person by virtual attendance or represented by proxy and entitled to vote. Abstentions will have the effect of a vote “AGAINST” Proposals 4A-4E. Broker non-votes will have no effect on the vote for Proposals 4A-4E.

Proposal 5 — The Directors Proposal requires a plurality of the votes cast. Withhold votes and broker non-votes will have no effect on the vote for Proposal 5.

Proposal 6 — The Stock Plan Proposal requires the affirmative vote of the majority of the issued and outstanding shares of common stock present in person by virtual attendance or represented by proxy and entitled to vote. Abstentions will have the effect of a vote “AGAINST” Proposal 6. Broker non-votes will have no effect on the vote for Proposal 6.

Proposal 7 — The Nasdaq Merger Proposal requires the affirmative vote of the majority of the issued and outstanding shares of common stock present by virtual attendance or represented by proxy and entitled to vote at the Meeting. Abstentions will have the effect of a vote “AGAINST” Proposal 7. Broker non-votes will have no effect on the vote for Proposal 7.

Proposal 8 — The Nasdaq PIPE Proposal requires the affirmative vote of the majority of the issued and outstanding shares of common stock present by virtual attendance or represented by proxy and entitled to vote at the Meeting. Abstentions will have the effect of a vote “AGAINST” Proposal 8. Broker non-votes will have no effect on the vote for Proposal 8.

Proposal 9 — The Adjournment Proposal requires the affirmative vote of the majority of the issued and outstanding shares of common stock present in person by virtual attendance or represented by proxy and entitled to vote at the Meeting. Abstentions will have the effect of a vote “AGAINST” Proposal 9. Broker-non votes have no effect on the vote for Proposal 9.

Q: Are any of the Proposals conditioned on one another?

A: The Business Combination Proposal is conditioned upon the approval of Proposals 2, 3, 5, 6, 7 and 8. Proposals 2, 3, 4, 5, 6, 7 and 8 are dependent upon approval of the Business Combination Proposal. It is important for you to note that in the event that the Business Combination Proposal is not approved, CLAQ will not consummate the Business Combination. If CLAQ does not consummate the Business Combination and fails to complete an initial business combination by July 19, 2022, CLAQ will be required to dissolve and liquidate, unless we seek stockholder approval to amend our Certificate of Incorporation to extend the date by which the Business Combination may be consummated.

Q: What will happen in the Business Combination?

A: At the closing of the Business Combination, Merger Sub will merge with and into Nauticus, with Nauticus surviving such merger as the surviving entity. Upon consummation of the Business Combination, Nauticus will become a wholly-owned subsidiary of CLAQ. In connection with the Business Combination, the cash held in the Trust Account after giving effect to any redemption of shares by CLAQ’s public stockholders and the proceeds from the PIPE Investment will be used to pay certain fees and expenses in connection with the Business Combination, and for working capital and general corporate purposes. A copy of the Merger Agreement is attached to this proxy statement/prospectus as *Annex A*.

Q: How will the Initial Stockholders vote?

A: In connection with the execution of the Merger Agreement, the Co-Sponsors entered into the Sponsor Support Agreement with Nauticus pursuant to which they agreed to vote all shares of common stock beneficially owned by them in favor of the Business Combination Proposal (“Sponsor Support Agreement”).

As of _____, 2022, a total of 4,032,500 shares of common stock or approximately 18.7% of the outstanding shares were subject to the Sponsor Support Agreement. In addition, pursuant to a letter agreement dated July 14, 2021, the Initial Stockholders agreed to vote their respective shares of common stock acquired by them prior to the IPO and any

shares of common stock purchased by them in the open market after the IPO in favor of the Business Combination Proposal (“Letter Agreement”). As of _____, 2022, a total of 4,312,500 shares of common stock held by CLAQ officers (2,595,000 shares, or 12.0%), directors (4,252,500 shares, or 19.7%) and CLAQ Co-Sponsors (4,032,500 shares or 18.7% in the aggregate), or approximately 20.0% of the outstanding shares were subject to the Letter Agreement. As a result, only 1,078,126 shares of common stock held by the public stockholders will need to be present in person by virtual attendance or by proxy to satisfy the quorum requirement for the meeting. In addition, as the vote to approve the Business Combination Proposal is a majority of the then outstanding shares of common stock present and entitled to vote at the Meeting, assuming only the minimum number of shares of common stock to constitute a quorum is present, only 539,063 shares of common stock or approximately 3.1% of the outstanding shares of the common stock held by the public stockholders must vote in favor of the Business Combination Proposal for it to be approved.

Pursuant to the Nauticus Support Agreement (defined below), Nauticus’ directors, executive officers and their affiliates have agreed to vote in favor of the Business Combination at Nauticus’ special meeting to approve the Business Combination. These directors, executive officers and their affiliates represent the holders of approximately 88.8% of the voting power of Nauticus. As such, they do not require additional votes from other stockholders to vote in favor of the Business Combination.

Q: How many votes do I and others have?

A: You are entitled to one vote for each share of common stock that you held as of the Record Date. As of the close of business on the Record Date, there were _____ outstanding shares of common stock.

Q: Will the transaction qualify as a “reorganization” within the meaning of Section 368(a) of the Internal Revenue Code of 1986, as amended?

A: While the parties intend for the transaction to qualify as a “reorganization” within the meaning of Section 368(a) of the Internal Revenue Code, there is no assurance that will indeed be the case. In the event that the transaction fails to qualify as such, there would be no adverse tax consequences to CLAQ or Merger Sub.

Q: Did the CLAQ Board obtain a fairness opinion in determining whether or not to proceed with the Business Combination?

A: After careful consideration of the terms and conditions of the Merger Agreement, the CLAQ Board determined in December 2021 that Business Combination and the transactions contemplated thereby are fair to, and in the best interests of, CLAQ and its stockholders. In reaching its decision with respect to the Business Combination and the transactions contemplated thereby, the CLAQ Board reviewed various industry and financial data and the evaluation of materials provided by Nauticus. Although the CLAQ Board did not obtain a third-party valuation or fairness opinion in connection with its resolution to approve the Merger but determined that CLAQ’s management, CleanTech Sponsor and the members of the Board had substantial experience in evaluating the operating, financial and business merits of companies similar to Nauticus, sufficient to make its own determination of the merits of a business combination with Nauticus.

On January 28, 2022, in order to provide added transparency to the transactions contemplated by the Merger Agreement and greater certainty to close the Business Transaction in the current turbulent market, CLAQ retained Duff & Phelps to serve as an independent financial advisor to the Board of CLAQ, specifically to provide to the Board a fairness opinion in connection with the Business Combination. On March 24, 2022, the CLAQ Board (solely in their capacity as members of the CLAQ Board) obtained an opinion from Duff & Phelps that the consideration to be paid by CLAQ to the Nauticus securityholders in the Business Combination pursuant to the Merger Agreement is fair to CLAQ, from a financial point of view. There was no separate opinion rendered on the fairness of the Business Combination to the public shareholders or shareholders unaffiliated with the Co-Sponsors or their affiliates. See “*Proposal 1 — The Business Combination Proposal — Opinion of CLAQ’s Financial Advisor*” and the opinion (as described below) attached to the proxy statement/prospectus as Exhibit F.

Q: What is the consideration being paid to Nauticus security holders?

Preferred Stock. Immediately prior to the Effective Time, each share of Nauticus Preferred Stock that is issued and outstanding immediately prior to such time shall automatically convert into shares of Nauticus Common stock, par value \$0.01 per share (the “Nauticus Common Stock”), in accordance with its Certificate of Incorporation (collectively, the “Nauticus Preferred Stock Conversion”). As a result of the Merger, an aggregate of 15,062,524 shares of CLAQ Common Stock will be issued to the holders of Nauticus Preferred Stock.

Convertible Notes. Immediately prior to the Effective Time, each of (i) that certain Unsecured Convertible Promissory Note, dated June 19, 2021, by and between Goradia Capital, LLC and Nauticus, as amended on December 16, 2021, (ii) that certain Unsecured Convertible Promissory Note, August 3, 2021, by and between Material Impact Fund II, L.P. and Nauticus, as amended on December 16, 2021, (iii) that certain Unsecured Convertible Promissory Note, dated October 22, 2021, by and between In-Q-Tel, Inc. and Nauticus, as amended on December 16, 2021, (iv) that certain Unsecured Convertible Promissory Note, dated July 28, 2020, by and between Schlumberger Technology Corporation and Nauticus, as amended on December 16, 2021, and (v) that certain Unsecured Convertible Promissory Note, dated December 7, 2020, by and between Transocean Inc. and Nauticus, as amended on December 16, 2021 (each, a “Nauticus Convertible Note” and collectively, the “Nauticus Convertible Notes”) shall automatically convert into shares of Nauticus Common Stock in accordance with the terms of each such Nauticus Convertible Note (collectively, the “Nauticus Convertible Notes Conversion”). As a result of the Merger, an aggregate of 5,299,543 shares of CLAQ Common Stock will be issued to the holders of Nauticus Convertible Notes.

Common Stock. At the Effective Time, following the Nauticus Preferred Stock Conversion and Nauticus Convertible Notes Conversion, each share of Nauticus Common Stock (including shares of Nauticus Common Stock outstanding as a result of the Nauticus Preferred Stock Conversion and Nauticus Convertible Notes Conversion, but excluding shares of the holders of which perfect rights of appraisal under Delaware law) will be converted into the right to receive the Per Share Merger Consideration of 14.2069 (as defined below) shares of CLAQ Common Stock and the Earnout Shares (as defined below). As a result of the Merger, an aggregate of 9,669,216 shares of CLAQ Common Stock will be issued to the holders of Nauticus Common Stock (not including the Earnout Shares).

Stock Options. At the Effective Time, each outstanding option to purchase shares of Nauticus Common Stock (a “Nauticus Option”), whether or not then vested and exercisable, will be assumed by CLAQ and converted automatically (and without any required action on the part of such holder of outstanding option) into an option to purchase shares of the CLAQ’s Common Stock equal to the number of shares determined by multiplying the number of shares of the Nauticus Common Stock subject to such Nauticus Option immediately prior to the Effective Time by the Exchange Ratio of 14.2069 (as defined below), which product shall be rounded down to the nearest whole number of shares, at a per share exercise price determined by dividing the per share exercise price of such Nauticus Option immediately prior to the Effective Time by the Exchange Ratio. As a result of the Merger, an aggregate of 3,977,368 shares of CLAQ Common Stock will be issuable upon exercise of these options.

Earnout Shares. Following the closing of the merger, former holders of shares of Nauticus Common Stock (including shares received as a result of the Nauticus Preferred Stock conversion and the Nauticus Convertible Notes conversion, the “Stockholder Earnout Group”) shall be entitled to receive their pro rata share of up to 7,500,000 additional shares of Combined Company Common Stock (the “Earnout Shares”). The Earnout Shares will be released and delivered to the Stockholder Earnout Group upon occurrence of the following (each, a “Triggering Event”):

- (i) one-half of the Escrow Shares will be released if, within a 5-year period following the signing date of the Merger Agreement, the volume-weighted average price of the Combined Company Common Stock equals or exceeds \$15.00 per share, over any 20 trading days within a 30-day trading period.
- (ii) one-quarter of the Escrow Shares will be released if, within a 5-year period following the signing date of the Merger Agreement, the volume-weighted average price of the Combined Company Common Stock equals or exceeds \$17.50 per share over any 20 trading days within a 30-day trading period; and
- (iii) one-quarter of the Escrow Shares will be released if, within a 5-year period following the signing date of the Merger Agreement, the volume-weighted average price of the Combined Company Common Stock equals or exceeds \$20.00 per share over any 20 trading days within a 30-day trading period.

Q: What equity stake will current stockholders of CLAQ and Nauticus stockholders hold in the Combined Company after the closing?

A. It is anticipated that upon completion of the Business Combination and assuming no redemptions by CLAQ public stockholders, CLAQ’s public stockholders (other than the PIPE Investors) will retain an ownership interest of approximately 28.5% in the Combined Company the PIPE Investors will own approximately 5.6% of the Combined Company, the Co-Sponsors, officers, directors and other holders of founder shares will retain an ownership interest of approximately 6.8% of the Combined Company, and the Nauticus stockholders will own approximately 59.1% (including the 7,500,000 Earnout Shares) of the Combined Company.

The ownership percentage with respect to the Combined Company does not take into account (i) the redemption of any Public Common Stock by the CLAQ public stockholders, (ii) the issuance of any additional shares upon the closing of the Business Combination under the Incentive Award Plan, and (iii) the issuance of the Debentures and associated warrants in connection with the Debt Financing. If the actual facts are different from these assumptions (which they are likely to be), the percentage ownership retained by the CLAQ stockholders will be different. See “*Unaudited Pro Forma Condensed Combined and Consolidated Financial Information.*”

The following table illustrates varying ownership levels in the Combined Company, assuming consummation of the Business Combination and no redemptions by CLAQ public stockholders, 10% redemption by CLAQ public stockholders, 50% redemption by CLAQ public stockholders, 75% redemption by Public Shareholders and the maximum redemptions by CLAQ public stockholders:

	No Redemptions ⁽¹⁾		10% Redemption ⁽²⁾		50% Redemption ⁽³⁾		75% Redemption ⁽⁴⁾		Maximum Redemption ⁽⁵⁾	
		%		%		%		%		%
Nauticus stockholders ⁽⁶⁾	41,508,647	46.5%	41,508,647	47.4%	41,508,647	51.5%	41,508,647	54.3%	41,508,647	57.6%
CLAQ public stockholders ⁽⁷⁾	26,737,500	29.9%	25,012,500	28.5%	18,112,500	22.4%	13,800,000	18.1%	9,487,500	13.2%
Initial Stockholders ⁽⁸⁾⁽⁹⁾	11,487,500	12.9%	11,487,500	13.1%	11,487,500	14.2%	11,487,500	15.0%	11,487,500	15.9%
PIPE Investment investors ⁽¹⁰⁾	9,603,470	10.7%	9,603,470	11.0%	9,603,470	11.9%	9,603,470	12.6%	9,603,470	13.3%
Pro forma fully diluted Common Stock at March 31, 2022	89,337,117	100.0%	87,612,117	100.0%	80,712,117	100.0%	76,399,617	100.0%	72,087,117	100.0%

- (1) Assumes that no CLAQ public stockholders are redeemed.
- (2) Assumes that 1,725,000 Public Common Stock is redeemed for aggregate redemption payments of approximately \$17,424,797, assuming a \$10.10 per share redemption price and based on funds in the Trust Account as of March 31, 2022. The Merger Agreement includes a condition to the closing that at the closing having an amount of available cash from the Trust Account and the PIPE Investment (after giving effect to the redemption of any Public Common Stock in connection with the IPO and the payment of the transaction expenses), of no less than \$50,000,000.
- (3) Assumes that 8,625,000 Public Common Stock is redeemed for aggregate redemption payments of approximately \$87,123,987, assuming a \$10.10 per share redemption price and based on funds in the Trust Account as of March 31, 2022. The Merger Agreement includes a condition to the closing that at the closing having an amount of available cash from the Trust Account and the Equity Financing (as defined in the Merger Agreement) (after giving effect to the redemption of any Public Common Stock in connection with the IPO and the payment of the transaction expenses), of no less than \$50,000,000.
- (4) Assumes that 12,937,500 Public Common Stock is redeemed for aggregate redemption payments of approximately \$130,685,980, assuming a \$10.10 per share redemption price and based on funds in the Trust Account as of March 31, 2022. The Merger Agreement includes a condition to the closing that at the closing having an amount of available cash from the Trust Account and the Equity Financing (as defined in the Merger Agreement) (after giving effect to the redemption of any Public Common Stock in connection with the IPO and the payment of the transaction expenses), of no less than \$50,000,000.
- (5) Assumes that 17,250,000 Public Common Stock is redeemed for aggregate redemption payments of approximately \$174,247,973, assuming a \$10.10 per share redemption price and based on funds in the Trust Account as of March 31, 2022. The Merger Agreement includes a condition to the closing that at the closing having an amount of available cash from the Trust Account and the PIPE Investment (after giving effect to the redemption of any Public Common Stock in connection with the IPO and the payment of the transaction expenses), of no less than \$50,000,000.
- (6) Includes 7,500,000 shares of Common Stock subject to the Earnout Terms and the exercise of 3,977,368 Nauticus Options. The Earnout Shares subject to the Triggering Events will be deposited into escrow in accordance with the terms of the Merger Agreement and will be subject to reduction or forfeiture in accordance with the terms of the Merger Agreement. However, registered holders will maintain voting rights related to such shares unless forfeited.
- (7) Includes 8,625,000 Public Warrants and the issuance of 862,500 shares of Common Stock pursuant to the Rights. Non-redeeming public stockholders could suffer additional dilution in their ownership and voting interest of the combined company upon exercise of the Public Warrants held by redeeming CLAQ public stockholder who continue to hold these warrants, which could have an aggregate value of \$3,967,500, based on the closing trading price per Public Warrant as of May 16, 2022.

[Table of Contents](#)

- (8) Includes 4,312,500 outstanding founder shares and 7,175,000 Private Warrants.
 (9) Total of 4,312,500 outstanding founder shares includes 1,437,500 founder shares held by the Sponsor, 2,595,000 founder shares held by CleanTech Investments, and 280,000 founder shares held by the officers and directors of CleanTech. Please see the section titled “Beneficial Ownership of Securities.”
 (10) Assumes the sale of an aggregate of 3,530,000 shares of CleanTech Common Stock, for a purchase price of \$10.00 per share and an aggregate purchase price of \$35,300,000, conversion of the Debentures at a conversion price of \$15.00 and exercise and conversion of the Warrants into Common Stock.

The following table illustrates estimated ownership levels in the Combined Company, immediately following the consummation of the Business Combination, based on the varying levels of redemptions by the CLAQ public stockholders and the following additional assumptions and the potential impact of redemptions on the value, on a per-share basis, of the shares owned by non-redeeming CLAQ public stockholders across varying levels of redemptions:

	No Redemptions ⁽¹⁾		10% Redemption ⁽²⁾		50% Redemption ⁽³⁾		75% Redemption ⁽⁴⁾		Maximum Redemption ⁽⁵⁾	
	Value Per Share ⁽⁶⁾		Value Per Share ⁽⁶⁾		Value Per Share ⁽⁶⁾		Value Per Share ⁽⁶⁾		Value Per Share ⁽⁶⁾	
	Shares	Share ⁽⁶⁾	Shares	Share ⁽⁶⁾	Shares	Share ⁽⁶⁾	Shares	Share ⁽⁶⁾	Shares	Share ⁽⁶⁾
Base Scenario ⁽⁷⁾	63,486,279	\$ 10.00	61,761,279	\$ 10.00	54,861,279	\$ 10.00	50,548,779	\$ 10.00	46,236,279	\$ 10.00
Exercising Public Warrants ⁽⁸⁾⁽¹²⁾	72,111,279	\$ 8.80	70,386,279	\$ 8.78	63,486,279	\$ 8.64	59,173,779	\$ 8.54	54,861,279	\$ 8.43
Exercising Private Warrants ⁽⁹⁾⁽¹²⁾	70,661,279	\$ 8.99	68,936,279	\$ 8.96	62,036,279	\$ 8.84	57,723,779	\$ 8.76	53,411,279	\$ 8.66
Exercising Public and Private Warrants ⁽¹⁰⁾⁽¹²⁾	79,286,279	\$ 8.01	77,561,279	\$ 7.96	70,661,279	\$ 7.76	66,348,779	\$ 7.62	62,036,279	\$ 7.45
Exercising Public, Private Warrants, Nauticus Options, Debentures and Warrants ⁽¹¹⁾⁽¹²⁾	89,337,117	\$ 7.11	87,612,117	\$ 7.05	80,712,117	\$ 6.80	76,399,617	\$ 6.62	72,087,117	\$ 6.41

- (1) Assumes that no Public Common Stock is redeemed.
 (2) Assumes that 1,725,000 Public Common Stock is redeemed for aggregate redemption payments of approximately \$17,424,797, assuming a \$10.10 per share redemption price and based on funds in the Trust Account as of March 31, 2022. The Merger Agreement includes a condition to the closing that at the closing having an amount of available cash from the Trust Account and the PIPE Investment (after giving effect to the redemption of any Public Common Stock in connection with the IPO and the payment of the transaction expenses), of no less than \$50,000,000.
 (3) Assumes that 8,625,000 Public Common Stock is redeemed for aggregate redemption payments of approximately \$87,123,987, assuming a \$10.10 per share redemption price and based on funds in the Trust Account as of March 31, 2022. The Merger Agreement includes a condition to the closing that at the closing having an amount of available cash from the Trust Account and the Equity Financing (as defined in the Merger Agreement) (after giving effect to the redemption of any Public Common Stock in connection with the IPO and the payment of the transaction expenses), of no less than \$50,000,000.
 (4) Assumes that 12,937,500 Public Common Stock is redeemed for aggregate redemption payments of approximately \$130,685,980, assuming a \$10.10 per share redemption price and based on funds in the Trust Account as of March 31, 2022. The Merger Agreement includes a condition to the closing that at the closing having an amount of available cash from the Trust Account and the Equity Financing (as defined in the Merger Agreement) (after giving effect to the redemption of any Public Common Stock in connection with the IPO and the payment of the transaction expenses), of no less than \$50,000,000.
 (5) Assumes that 17,250,000 Public Common Stock is redeemed for aggregate redemption payments of approximately \$174,247,973, assuming a \$10.10 per share redemption price and based on funds in the Trust Account as of March 31, 2022. The Merger Agreement includes a condition to the closing that at the closing having an amount of available cash from the Trust Account and the PIPE Investment (after giving effect to the redemption of any Public Common Stock in connection with the IPO and the payment of the transaction expenses), of no less than \$50,000,000.
 (6) Based on a post-transaction equity value of approximately \$634.9 million, \$617.6 million, \$548.6 million, \$505.5 million, and \$462.4 million under the No Redemptions, 10% Redemption, 50% Redemption, 75% Redemption, and Maximum Redemption scenarios, respectively.
 (7) Represents the post-Closing share ownership assuming various levels of redemption by CLAQ Public Stockholders.
 (8) Represents the Base Scenario plus the full exercise of the 8,625,000 Public Warrants.
 (9) Represents the Base Scenario plus the full exercise of the 7,175,000 Private Warrants.
 (10) Represents the Base Scenario plus the full exercise of the 8,625,000 Public Warrants and the 7,175,000 Private Warrants.
 (11) Represents the Base Scenario plus the full exercise of the 8,625,000 Public Warrants, 7,175,000 Private Warrants, 3,977,368 Nauticus Options, 3,036,735 shares of Common Stock pursuant to the conversion of the Debentures and 3,036,735 shares of Common Stock pursuant to the full exercise of the Warrants.
 (12) Analysis does not account for exercise prices to be paid in connection with the exercise of warrants.

Q: Do any of CLAQ's directors or officers have interests that may conflict with my interests with respect to the Business Combination?

A: In considering the recommendation of the Board to approve the Merger Agreement, CLAQ stockholders should be aware that certain CLAQ executive officers and directors have interests in the Business Combination that are different from, or in addition to, those of CLAQ stockholders generally. When you consider the recommendation of the Board in favor of adoption of the Business Combination Proposal and other Proposals, you should keep in mind that CLAQ's directors and officers and their affiliates have interests in the Business Combination that are different from, or in addition to, your interests as a shareholder, including:

- CLAQ's Co-sponsors have a fiduciary obligation to each of their respective members and Eli Spiro, (CLAQ's Chief Executive Officer and Director) and Jonas Grossman (a CLAQ Director) are the controlling members of our Co-sponsors. Because each of Mr. Spiro and Mr. Grossman have a fiduciary obligation to both CLAQ and the Co-sponsors, they had a conflict of interest when voting on the Business Combination.
- If an initial business combination, such as the Business Combination, is not completed, CLAQ will be required to dissolve and liquidate. In such event, the 4,312,500 founder shares currently held by the Initial Stockholders, which were acquired prior to the IPO will be worthless because such holders have agreed to waive their rights to any liquidation distributions. The founder shares were purchased for an aggregate purchase price of \$25,000, and had an aggregate market value of approximately \$43.3 million based on the closing price of \$10.03 per share of CLAQ common stock on the Nasdaq Stock Market as of May 20, 2022.
- If an initial business combination, such as the Business Combination, is not completed, an aggregate of 7,175,000 Private Warrants purchased by CLAQ's Co-sponsors for a total purchase price of \$7,175,000, will be worthless. The Private Warrants had an aggregate market value of approximately \$3.0 million based on the closing price of \$0.42 per Public Warrant on the Nasdaq Stock Market as of May 20, 2022.
- Because of these interests, CLAQ's Initial Stockholders could benefit from the completion of a business combination that is not favorable to its public shareholders and may be incentivized to complete an acquisition of a less favorable target company or on terms less favorable to public shareholders rather than liquidate. For example, if the share price of the CLAQ common stock declined to \$5.00 per share after the close of the business combination, CLAQ's public shareholder that purchased shares in the initial public offering, would have a loss of \$5.00 per share, while CLAQ's Sponsor would have a gain of \$4.99 per share because it acquired the founder shares for a nominal amount. In other words, CLAQ's Initial Stockholders can earn a positive rate of return on their investment even if public shareholders experience a negative rate of return in the post-combination company.
- One of CLAQ's Co-sponsors is CleanTech Sponsor, and the managing member of CleanTech Sponsor is Eli Spiro, CLAQ's Chief Executive Officer and Director. If an initial business combination, such as the Business Combination, is not completed, CleanTech Sponsor will lose an aggregate of approximately \$28.3 million, comprised of the following:
 - approximately \$26.0 million (based on the closing price of \$10.03 per share of CLAQ common stock on the Nasdaq Stock Market as of May 20, 2022) of the 2,595,000 founder shares CleanTech Sponsor holds;
 - approximately \$2.0 million (based on the closing price of \$0.42 per Public Warrant on the Nasdaq Stock Market as of May 20, 2022) of the 4,783,333 Private Warrants CleanTech Sponsor holds; and
 - repayment of an interest-free loan of \$267,000 by CleanTech Sponsor since the loan will become payable only after Closing of the Business Combination, or the date on which CLAQ determines that it is unable to effect a business combination.
- CLAQ's other Co-sponsor, CleanTech Investments, is an affiliate of Chardan, and CLAQ's director, Mr. Jonas Grossman, is the Managing Partner and President of Chardan. If an initial business combination, such as the Business Combination, is not completed, Chardan will lose an aggregate of approximately \$23.8 million, comprised of the following:
 - approximately \$14.4 million (based on the closing price of \$10.03 per share of CLAQ common stock on the Nasdaq Stock Market as of May 20, 2022) of the 1,437,500 founder shares CleanTech Investment holds;

[Table of Contents](#)

- approximately \$1.0 million (based on the closing price of \$0.42 per Public Warrant on the Nasdaq Stock Market as of May 20, 2022) of the 2,391,667 Private Warrants CleanTech Investment holds;
- a marketing fee of \$6,037,500 for certain services pursuant to a Business Combination Marketing Agreement;
- a placement fee of \$2,118,000 (i.e., 6.0% of the PIPE Investment that is not sold to an affiliate of Chardan) for certain services pursuant to the Financial Advisory Agreement (pursuant to the Financial Advisory Agreement, Chardan also has a right of first refusal to act as a book-running manager with minimum economics of 15% for the first two public or private equity offerings by CLAQ or any successor or subsidiary of CLAQ);
- repayment of an interest-free loan of \$133,000 by CleanTech Investments since the loan will become payable only after Closing of the Business Combination, or the date on which CLAQ determines that it is unable to effect a business combination; and
- the \$10,000 monthly administrative fee under the Administrative Support Agreement pursuant to which CLAQ may delay payment of the same until the consummation of a business combination. As of March 2022, there is an accrued and unpaid balance of \$83,333 owed to Chardan under the Administrative Support Agreement.
- If an initial business combination, such as the Business Combination, is not completed, the Initial Stockholders will lose a combined aggregate amount of approximately \$46.7 million (including the Co-sponsors' loans and securities held based on the closing price of \$10.03 per share of CLAQ common stock and \$0.42 per Public Warrant on May 20, 2022), and the Initial Stockholders together with their affiliates (including Chardan) will lose a combined aggregate amount of approximately \$54.9 million (including Chardan's fees contingent upon the Closing of the Business Combination.)
- If the proposed Business Combination is not completed, CLAQ's Initial Stockholders will not have the potential ownership interest of approximately 6.8% (assuming no redemption) or 8.6% (assuming maximum redemption) in the combined company, assuming exercise and conversion of all securities.
- As of the date of this proxy statement/prospectus, ATW is the only purchaser for the Debentures and associated Warrants in the Debt Financing. ATW is managed by ATW Partners Opportunities Management, LLC, which is an affiliate of Chardan, and our director, Mr. Jonas Grossman, is the Managing Partner and President of Chardan.
- The exercise of CLAQ's directors' and officers' discretion in agreeing to changes or waivers in the terms of the transaction may result in a conflict of interest when determining whether such changes or waivers are appropriate and in our stockholders' best interest.
- If the Business Combination is completed, Nauticus will designate all members of the Combined Company's Board of Directors, except for the Transocean Designee).

See "Proposal 1 — The Business Combination Proposal — Interests of Certain Persons in the Business Combination" beginning on page 124.

Q: Are there any arrangements to help ensure that CLAQ will have sufficient funds, together with the proceeds in its Trust Account, to fund the consideration?

- A: Yes. CLAQ entered into subscription agreements, dated as of December 14, 2021, with certain investors pursuant to which, among other things, CLAQ agreed to issue and sell, in a private placement to close immediately prior to the closing of the Business Combination, an aggregate of 3,530,000 shares of our common stock for \$10.00 per share for a total of \$35.3 million (the "Equity Financing"). To the extent not utilized to consummate the Business Combination, the proceeds from the Trust Account will be used for general corporate purposes, including, but not limited to, working capital for operations, capital expenditures and future acquisitions. CLAQ will agree that it (or its successor) will file with the SEC a registration statement registering the resale of the shares purchased in the Equity Financing and use its commercially reasonable efforts to have the registration statement declared effective as soon as practicable.

In addition, CLAQ entered into a Securities Purchase Agreement with certain investors purchasing up to an aggregate of \$40.0 million in principal amount of secured debentures (the “Debentures”) and warrants. The number of shares of common stock into which the Debentures are convertible is equal to 120% of the outstanding principal amount of the Debentures divided by the conversion price of \$15.00, and the number of shares of common stock into which the associated warrants are exercisable is equal to 120% of the outstanding principal amount of the Debentures divided by the conversion price, with an exercise price equal to \$20, subject to adjustment (the “Debt Financing,” and together with the Equity Financing, the “PIPE Investment”). The exercise price of the associated warrant will be subject to (i) customary anti-dilution adjustments; and (ii) in the case of a subsequent equity sale at a per share price below the exercise price, the exercise price of the associated warrant will be adjusted to such lower price, and the number of shares underlying the warrant will increase proportionately. In the event of a rights offering or dividend, the warrant holder will be treated as though the shares underlying the warrant he/she holds were outstanding. These warrants can be exercised on a cashless basis. There will be an original issue discount of 2% from the issued amount of the Debentures. Interest will accrue on all outstanding principal amount of the Debentures at 5% per annum, payable quarterly. The Debentures will be secured by first priority interests, and liens on, all present and after-acquired assets of the Combined Company, and will mature on the fourth anniversary of the date of issuance. As of the date of this proxy statement/prospectus, ATW Special Situations I LLC (“ATW”) is the only purchaser and has subscribed for Debentures in the an aggregate principal amount of \$37,959,184 (out of the aggregate \$40.0 million) which is convertible into 3,036,735 shares of the Combined Company’s common stock and associated warrants for an additional 3,036,735 shares of the Combined Company’s common stock. ATW is managed by ATW Partners Opportunities Management, LLC, which is an affiliate of Chardan Capital Markets, LLC (“Chardan”), and our director, Mr. Jonas Grossman, is the Managing Partner and President of Chardan. Chardan will not receive any fees or compensation for ATW’s participation in the Debt Financing. The obligations to consummate the transactions contemplated by the Securities Purchase Agreement are conditioned upon, among other things, (i) raising \$25,000,000 in equity financing from strategic investors, (ii) hiring a chief financial officer with public company experience, and (iii) all conditions precedent to the Merger set forth in the Merger Agreement having been satisfied or waived. The Equity Financing will satisfy the closing condition related to the equity financing requirement for the Debt Financing, and the PIPE Investment alone will satisfy the Minimum Cash Condition under the Merger Agreement. Mr. Rangan Padmanabhan, Nauticus’ current CFO will be the CFO of the Company effective as of the date of the merger, satisfying the closing condition related to the hiring of a CFO with public company experience requirement for the Debt Financing.

Q: What are the material differences, if any, in the terms and price of securities issued at the time of the CLAQ IPO as compared to the securities that will be issued a part of the PIPE Investment at the closing of the Business Combination? Will CLAQ Sponsor or any of its directors, officers or affiliates invest in the PIPE Investment?

A: The CLAQ units issued at the time of the CLAQ IPO consisted of one share of CLAQ Class A Common Stock, one-half of one CLAQ warrant, and one right at an offering price of \$10.00 per unit. CLAQ entered into subscription agreements, dated as of December 14, 2021, with the Equity Financing investors pursuant to which, among other things, CLAQ agreed to issue and sell, in a private placement to close immediately prior to the closing of the Business Combination, an aggregate of 3,530,000 shares of our common stock for \$10.00 per share for a total of \$35.3 million.

In addition, CLAQ entered into a Securities Purchase Agreement with certain investors purchasing up to an aggregate of \$40.0 million in principal amount of Debentures and warrants. The number of shares of common stock into which the Debentures are convertible is equal to 120% of the outstanding principal amount of the Debentures divided by the conversion price of \$15.00, and the number of shares of common stock into which the associated warrants are exercisable is equal to 120% of the outstanding principal amount of the Debentures divided by the conversion price, with an exercise price equal to \$20, subject to adjustment. The exercise price of the associated warrant will be subject to (i) customary anti-dilution adjustments; and (ii) in the case of a subsequent equity sale at a per share price below the exercise price, the exercise price of the associated warrant will be adjusted to such lower price, and the number of shares underlying the warrant will increase proportionately. In the event of a rights offering or dividend, the warrant holder will be treated as though the shares underlying the warrant he/she holds were outstanding. These warrants can be exercised on a cashless basis. There will be an original issue discount of 2% from the issued amount of the Debentures. Interest will accrue on all outstanding principal amount of the Debentures at 5% per annum, payable quarterly. The Debentures will be secured by first priority interests, and liens on, all present and after-acquired assets of the Combined Company, and will mature on the fourth anniversary of the date of issuance. As of the date of this proxy statement/prospectus, ATW is the only purchaser and has subscribed for Debentures in the an aggregate

principal amount of \$37,959,184 (out of the aggregate \$40.0 million) which is convertible into 3,036,735 shares of the Combined Company's common stock and associated warrants for an additional 3,036,735 shares of the Combined Company's common stock. ATW is managed by ATW Partners Opportunities Management, LLC, which is an affiliate of Chardan, and our director, Mr. Jonas Grossman, is the Managing Partner and President of Chardan. Chardan will not receive any fees or compensation for ATW's participation in the Debt Financing. The obligations to consummate the transactions contemplated by the Securities Purchase Agreement are conditioned upon, among other things, (i) raising \$25,000,000 in equity financing from strategic investors, (ii) hiring a chief financial officer with public company experience, and (iii) all conditions precedent to the Merger set forth in the Merger Agreement having been satisfied or waived. The Equity Financing will satisfy the closing condition related to the equity financing requirement for the Debt Financing, and the PIPE Investment alone will satisfy the Minimum Cash Condition under the Merger Agreement. Mr. Rangan Padmanabhan, Nauticus' current CFO will be the CFO of the Company effective as of the date of the merger, satisfying the closing condition related to the hiring of a CFO with public company experience requirement for the Debt Financing.

CLAQ Sponsors and its directors, officers and its affiliates will not invest in the PIPE Investment. The shares issued in the PIPE Investment will not be registered under the Securities Act, in reliance upon the exemption provided in Section 4(a)(2) of the Securities Act.

Q: When and where is the Meeting?

A: The Meeting will take place at _____, on _____, 2022, at _____ a.m./p.m.

Q: Who may vote at the Meeting?

A: Only holders of record of common stock as of the close of business on _____, 2022 may vote at the Meeting of stockholders. As of _____, there were _____ shares of common stock outstanding and entitled to vote. Please see "*The Meeting — Record Date; Who is Entitled to Vote*" for further information.

Q: What is the quorum requirement for the Meeting?

A: Stockholders representing a majority of the shares of common stock issued and outstanding as of the Record Date and entitled to vote at the Meeting must be present in person by virtual attendance or represented by proxy in order to hold the Meeting and conduct business. This is called a quorum. Shares of our common stock will be counted for purposes of determining if there is a quorum if the stockholder (i) is present and entitled to vote at the meeting, or (ii) has properly submitted a proxy card or voting instructions through a broker, bank or custodian. In the absence of a quorum, stockholders representing a majority of the votes present in person or represented by proxy at such meeting may adjourn the meeting until a quorum is present.

Q: Am I required to vote against the Business Combination Proposal in order to have my Public Common Stock redeemed?

A: No. You are not required to vote against the Business Combination Proposal in order to have the right to demand that CLAQ redeem your Public Common Stock for cash equal to your pro rata share of the aggregate amount then on deposit in the Trust Account (before payment of deferred underwriting commissions and including interest earned on their pro rata portion of the Trust Account, net of taxes payable). These rights to demand redemption of Public Common Stock for cash are sometimes referred to herein as "redemption rights". If the Business Combination is not completed, holders of Public Common Stock electing to exercise their redemption rights will not be entitled to receive such payments and their shares of common stock will be returned to them.

Q: How do I exercise my redemption rights?

A: If you are a public stockholder and you seek to have your Public Common Stock redeemed, you must (i) demand, no later than 5:00 p.m., Eastern Time on _____, 2022 (at least two business days before the Meeting), that CLAQ redeem your shares into cash; and (ii) submit your request in writing to Continental, at the address listed at the end of this answer and deliver your shares to Continental physically or electronically using The Depository Trust Company's ("DTC") DWAC (Deposit/Withdrawal at Custodian) System at least two business days before the Meeting.

Any corrected or changed written demand of redemption rights must be received by Continental two business days before the Meeting. No demand for redemption will be honored unless the holder's shares have been delivered (either physically or electronically) to Continental at least two business days before the Meeting.

You may seek to have your Public Common Stock redeemed regardless of whether you vote for or against the Business Combination and whether or not you are holders of common stock as of the Record Date. Any public stockholder who holds shares of common stock on or before _____, 2022 (two business days before the Meeting) will have the right to demand that his, her or its shares be redeemed for a pro rata share of the aggregate amount then on deposit in the Trust Account, less any taxes then due but not yet paid, at the consummation of the Business Combination.

The actual per share redemption price will be equal to the aggregate amount then on deposit in the Trust Account (before payment of deferred underwriting commissions and including interest earned on their pro rata portion of the Trust Account, net of taxes payable), divided by the number of shares of common stock underlying the CLAQ Units sold in the IPO. Please see the section titled “*The Meeting — Redemption Rights*” for the procedures to be followed if you wish to redeem your shares of common stock for cash.

Exercise of your redemption rights will not result in either the exercise or loss of any of the warrants you may hold. Your warrants will continue to be outstanding following a redemption of your Public Common Stock and will become exercisable in connection with the completion of the Business Combination.

If you intend to seek redemption of your Public Common Stock, you will need to deliver your shares (either physically or electronically) to Continental, our Transfer Agent, prior to the Meeting, as described in this Proxy Statement/Prospectus. If you have questions regarding the certification of your position or delivery of your shares, please contact:

Continental Stock Transfer & Trust Company
One State Street, 30th Floor
New York, New York 10004
Attention: Mark Zimkind
E-mail: mzimkind@continentalstock.com

Q: What are the U.S. federal income tax consequences of exercising my redemption rights?

A: In the event that a U.S. Holder elects to redeem its common stock for cash, the treatment of the transaction for U.S. federal income tax purposes will depend on whether the redemption qualifies as a sale or exchange of common stock under Section 302 of the Code or is treated as a distribution under Section 301 of the Code. Whether the redemption qualifies as a sale or exchange or is treated as a distribution will depend on the facts and circumstances of each particular U.S. Holder at the time such U.S. Holder exercises his, her, or its redemption rights. If the redemption qualifies as a sale or exchange of the common stock, the U.S. Holder will be treated as recognizing capital gain or loss equal to the difference between the amount realized on the redemption and such U.S. Holder’s adjusted tax basis in the common stock surrendered in such redemption transaction. Any such capital gain or loss generally will be long-term capital gain or loss if the U.S. Holder’s holding period for the common stock redeemed exceeds one year. The deductibility of capital losses is subject to limitations. See “*Material U.S. Federal Income Tax Consequences — Certain Material U.S. Federal Income Tax Consequences of Exercising Redemption Rights*” for a more detailed discussion of the U.S. federal income tax consequences of a U.S. Holder electing to redeem its common stock for cash.

Q: What do I need to do now?

A: You are urged to read carefully and consider the information contained in this proxy statement/prospectus, including the annexes, and to consider how the Business Combination will affect you as a stockholder. You should then vote as soon as possible in accordance with the instructions provided in this proxy statement/prospectus and on the enclosed proxy card or, if you hold your shares through a brokerage firm, bank or other nominee, on the voting instruction form provided by the broker, bank or nominee.

Q: How can I vote?

A: If you are a stockholder of record, you may vote online at the virtual Meeting or vote by proxy using the enclosed proxy card, the Internet or telephone. Whether or not you plan to participate in the Meeting, we urge you to vote by proxy to ensure your vote is counted. Even if you have already voted by proxy, you may still attend the virtual Meeting and vote online, if you choose.

Table of Contents

To vote online at the virtual Meeting, follow the instructions below under “*How may I participate in the virtual Meeting?*”

To vote using the proxy card, please complete, sign and date the proxy card and return it in the prepaid envelope. If you return your signed proxy card before the Meeting, we will vote your shares as you direct.

To vote via the telephone, you can vote by calling the telephone number on your proxy card. Please have your proxy card handy when you call. Easy-to-follow voice prompts will allow you to vote your shares and confirm that your instructions have been properly recorded.

To vote via the Internet, please go to _____ and follow the instructions. Please have your proxy card handy when you go to the website. As with telephone voting, you can confirm that your instructions have been properly recorded.

Telephone and Internet voting facilities for stockholders of record will be available 24 hours a day until 11:59 p.m. Eastern Time on _____, 2022. After that, telephone and Internet voting will be closed, and if you want to vote your shares, you will either need to ensure that your proxy card is received before the date of the Meeting or attend the virtual Meeting to vote your shares online.

If your shares are registered in the name of your broker, bank or other agent, you are the “beneficial owner” of those shares and those shares are considered as held in “street name.” If you are a beneficial owner of shares registered in the name of your broker, bank or other agent, you should have received a proxy card and voting instructions with these proxy materials from that organization rather than directly from us. Simply complete and mail the proxy card to ensure that your vote is counted. You may be eligible to vote your shares electronically over the Internet or by telephone. A large number of banks and brokerage firms offer Internet and telephone voting. If your bank or brokerage firm does not offer Internet or telephone voting information, please complete and return your proxy card in the self-addressed, postage-paid envelope provided.

If you plan to vote at the virtual Meeting, you will need to contact Continental at the phone number or email below to receive a control number and you must obtain a legal proxy from your broker, bank or other nominee reflecting the number of shares of common stock you held as of the Record Date, your name and email address. You must contact Continental for specific instructions on how to receive the control number. Please allow up to 48 hours prior to the meeting for processing your control number.

After obtaining a valid legal proxy from your broker, bank or other agent, to then register to attend the Meeting, you must submit proof of your legal proxy reflecting the number of your shares along with your name and email address to Continental. Requests for registration should be directed to 917- _____ - _____ or email proxy@continentalstock.com. Requests for registration must be received no later than _____ p.m., Eastern Time, on _____, 2022.

You will receive a confirmation of your registration by email after we receive your registration materials. We encourage you to access the Meeting prior to the start time leaving ample time for the check in.

Q: How may I participate in the virtual Meeting?

- A. If you are a stockholder of record as of the Record Date for the Meeting, you should receive a proxy card from Continental, containing instructions on how to attend the virtual Meeting including the URL address, along with your control number. You will need your control number for access. If you do not have your control number, contact Continental at 917- _____ - _____ or email proxy@continentalstock.com.

You can pre-register to attend the virtual Meeting starting on _____, 2022. Go to http://_____, enter the control number found on your proxy card you previously received, as well as your name and email address. Once you pre-register you can vote or enter questions in the chat box. At the start of the Meeting you will need to re-log into http://_____ using your control number.

If your shares are held in street name, and you would like to join and not vote, Continental will issue you a guest control number. Either way, you must contact Continental for specific instructions on how to receive the control number. Please allow up to 48 hours prior to the meeting for processing your control number.

Q: Who can help answer any other questions I might have about the virtual Meeting?

- A: If you have any questions concerning the virtual Meeting (including accessing the meeting by virtual means) or need help voting your shares of common stock, please contact Continental at 917- - or email proxy@continentalstock.com.

The Notice of Special Meeting, proxy statement/prospectus and form of Proxy Card are available at: .

Q: If my shares are held in “street name” by my bank, brokerage firm or nominee, will they automatically vote my shares for me?

- A: No. If you are a beneficial owner and you do not provide voting instructions to your broker, bank or other holder of record holding shares for you, your shares will not be voted with respect to any Proposal for which your broker does not have discretionary authority to vote. If a Proposal is determined to be discretionary, your broker, bank or other holder of record is permitted to vote on the Proposal without receiving voting instructions from you. If a Proposal is determined to be non-discretionary, your broker, bank or other holder of record is not permitted to vote on the Proposal without receiving voting instructions from you. A “broker non -vote” occurs when a bank, broker or other holder of record holding shares for a beneficial owner does not vote on a non-discretionary proposal because the holder of record has not received voting instructions from the beneficial owner.

Each of the Proposals to be presented at the Meeting is a non-discretionary proposal. Accordingly, if you are a beneficial owner and you do not provide voting instructions to your broker, bank or other holder of record holding shares for you, your shares will not be voted with respect to any of the Proposals. A broker non-vote would have the same effect as a vote against the Business Combination Proposal, and the Adjournment Proposal.

Q: What if I abstain from voting or fail to instruct my bank, brokerage firm or nominee?

- A: CLAQ will count a properly executed proxy marked “ABSTAIN” with respect to a particular Proposal as present for the purposes of determining whether a quorum is present at the Meeting. For purposes of approval, an abstention on any Proposals will have the same effect as a vote “AGAINST” such Proposal.

Q: If I am not going to attend the Meeting, should I return my proxy card instead?

- A: Yes. Whether you plan to attend the Meeting virtually or not, please read the enclosed proxy statement/prospectus carefully, and vote your shares by completing, signing, dating and returning the enclosed proxy card in the postage-paid envelope provided.

Q: How can I submit a proxy?

- A: You may submit a proxy by (a) visiting and following the on screen instructions (have your proxy card available when you access the webpage), or (b) calling toll- f r e e in the U.S. or from foreign countries from any touch-tone phone and follow the instructions (have your proxy card available when you call), or (c) submitting your proxy card by mail by using the previously provided self-addressed, stamped envelope.

Q: Can I change my vote after I have mailed my proxy card?

- A: Yes. You may change your vote at any time before your proxy is voted at the Meeting. You may revoke your proxy by executing and returning a proxy card dated later than the previous one, or by attending the virtual Meeting in person and casting your vote or by voting again by the telephone or Internet voting options described below, or by submitting a written revocation stating that you would like to revoke your proxy that our proxy solicitor receives prior to the Meeting. If you hold your shares of common stock through a bank, brokerage firm or nominee, you should follow the instructions of your bank, brokerage firm or nominee regarding the revocation of proxies. If you are a record holder, you should send any notice of revocation or your completed new proxy card, as the case may be, to:

ADVANTAGE PROXY
P.O. Box 13581
Des Moines, WA 98198
Toll Free: (877) 870-8565
Collect: (206) 870-8565
Email: ksmith@advantageproxy.com

[Table of Contents](#)

Unless revoked, a proxy will be voted at the virtual Meeting in accordance with the stockholder's indicated instructions. In the absence of instructions, proxies will be voted FOR each of the Proposals.

Q: What will happen if I return my proxy card without indicating how to vote?

A: If you sign and return your proxy card without indicating how to vote on any particular Proposal, the shares of common stock represented by your proxy will be voted in favor of each Proposal. Proxy cards that are returned without a signature will not be counted as present at the Meeting and cannot be voted.

Q: Should I send in my share certificates now to have my shares of common stock redeemed?

A: CLAQ stockholders who intend to have their Public Common Stock redeemed should send their certificates to Continental at least two business days before the Meeting. Please see "*The Meeting — Redemption Rights*" for the procedures to be followed if you wish to redeem your Public Common Stock for cash.

Q: Who will solicit the proxies and pay the cost of soliciting proxies for the Meeting?

A: CLAQ will pay the cost of soliciting proxies for the Meeting. CLAQ has engaged Advantage Proxy to assist in the solicitation of proxies for the Meeting. CLAQ has agreed to pay Advantage Proxy a fee of \$10,000, plus disbursements, and will reimburse Advantage Proxy for its reasonable out-of-pocket expenses and indemnify Advantage Proxy and its affiliates against certain claims, liabilities, losses, damages, and expenses. CLAQ will also reimburse banks, brokers and other custodians, nominees and fiduciaries representing beneficial owners of common stock for their expenses in forwarding soliciting materials to beneficial owners of the common stock and in obtaining voting instructions from those owners. Our directors, officers and employees may also solicit proxies by telephone, by facsimile, by mail, on the Internet or in person. They will not be paid any additional amounts for soliciting proxies.

Q: What happens if I sell my shares before the Meeting?

A: The Record Date for the Meeting is earlier than the date of the Meeting, as well as the date that the Business Combination is expected to be consummated. If you transfer your shares of common stock after the Record Date, but before the Meeting, unless the transferee obtains from you a proxy to vote those shares, you would retain your right to vote at the Meeting, but will transfer ownership of the shares and will not hold an interest in CLAQ after the Business Combination is consummated.

Q: When is the Business Combination expected to occur?

A: Assuming the requisite regulatory and stockholder approvals are received, CLAQ expects that the Business Combination will occur as soon as possible following the Meeting.

Q: Are Nauticus' stockholders required to approve the Business Combination?

A: Yes. The Nauticus stockholders are required to also approve the Business Combination and have approved it.

Q: Are there risks associated with the Business Combination that I should consider in deciding how to vote?

A: Yes. There are a number of risks related to the Business Combination and other transactions contemplated by the Merger Agreement, that are discussed in this proxy statement/prospectus. Please read with particular care the detailed description of the risks described in "Risk Factors" beginning on page 45 of this proxy statement/prospectus.

Q: May I seek statutory appraisal rights or dissenter rights with respect to my shares?

A: No. Appraisal rights are not available to holders of shares of common stock in connection with the proposed Business Combination. For additional information, see the section titled "*The Meeting — Appraisal Rights*."

Q: What happens if the Business Combination is not consummated?

A: If CLAQ does not consummate the Business Combination by July 19, 2022, then pursuant to Article Sixth its current Amended and Restated Certificate of Incorporation, CLAQ's officers must take all actions necessary in accordance with the DGCL to dissolve and liquidate CLAQ as soon as reasonably possible. Following dissolution, CLAQ will no longer exist as a company. In any liquidation, the funds held in the Trust Account, plus any interest earned thereon (net of taxes payable), together with any remaining out-of-trust net assets, will be distributed pro-rata to holders of shares of common stock who acquired such shares in the IPO or in the aftermarket. The estimated consideration that each share of common stock would be paid at liquidation would be approximately \$10.10 per share for stockholders based on the amount on deposit in the Trust Account as of May 20, 2022. The closing price of our common stock on the Nasdaq Stock Market as of May 20, 2022 was \$10.03. The Initial Stockholders waived the right to any liquidation distribution with respect to any shares of common stock held by them.

Q: What happens to the funds deposited in the Trust Account following the Business Combination?

A: Following the closing of the Business Combination, holders of public shares of CLAQ exercising redemption rights will receive their per share redemption price out of the funds in the Trust Account. The balance of the funds will be released to Nauticus to fund working capital needs of the Combined Company. As of May 16, 2022, there was approximately \$174.2 million in the Trust Account. CLAQ estimates that approximately \$10.10 per share of Common Stock will be paid to the public stockholders exercising their redemption rights.

Q: Who will manage the Combined Company after the Business Combination?

A: As a condition to the closing of the Business Combination, all of the officers and directors of CLAQ will resign, other than Mr. Eli Spiro, who will serve as a director of the Combined Company, subject to certain closing conditions. For information on the anticipated management of the Combined Company, see the section titled "Directors and Executive Officers of the Combined Company after the Business Combination" in this proxy statement/prospectus.

Q: Who can help answer my questions?

A: If you have questions about the Proposals or if you need additional copies of this proxy statement/prospectus or the enclosed proxy card, you should contact CLAQ's proxy solicitor at:

ADVANTAGE PROXY
P.O. Box 13581
Des Moines, WA 98198
Toll Free: (877) 870-8565
Collect: (206) 870-8565
Email: ksmith@advantageproxy.com

You may also obtain additional information about CLAQ from documents filed with the SEC by following the instructions in the section titled "*Where You Can Find More Information.*"

SUMMARY OF THE PROXY STATEMENT/PROSPECTUS

This summary highlights selected information from this proxy statement/prospectus but may not contain all of the information that may be important to you. Accordingly, CLAQ encourages you to read carefully this entire proxy statement, including the Merger Agreement attached as Annex A. Please read these documents carefully as they are the legal documents that govern the Business Combination and your rights in the Business Combination.

Unless otherwise specified, all share calculations assume no exercise of the redemption rights by CLAQ's stockholders.

The Parties to the Business Combination

CleanTech Acquisition Corp.

CLAQ was incorporated as a blank check company formed under the laws of the State of Delaware on June 18, 2020. CLAQ was formed for the purpose of entering into a merger, share exchange, asset acquisition, stock purchase, recapitalization, reorganization or other similar business combination with one or more businesses or entities.

On July 19, 2021, CLAQ consummated the IPO of 15,000,000 Units at \$10.00 per Unit, generating gross proceeds of \$150,000,000. Simultaneously with the closing of the IPO, CLAQ consummated the sale of 4,333,333 warrants at a price of \$1.00 per Private Warrant in a private placement to CleanTech Sponsor ("CleanTech Sponsor"), and 2,166,667 warrants (together, the "Private Warrants") at a price of \$1.00 per Private Warrant in a private placement to CleanTech Investments LLC, an affiliate of CleanTech Sponsor ("CleanTech Investments," together with CleanTech Sponsor, the "Co-sponsors"), generating gross proceeds of \$6,500,000.

CLAQ granted the underwriters in the IPO a 45-day option to purchase up to 2,250,000 additional Units to cover over-allotments, if any. On July 28, 2021, the underwriters exercised the over-allotment option in full to purchase 2,250,000 Units, generating an aggregate of gross proceeds of \$22,500,000. In connection with the underwriters' exercise of their over-allotment option, CLAQ also consummated the sale of an additional 450,000 Private Warrants at \$1.00 per Private Warrant to CleanTech Sponsor and 225,000 Private Warrants at \$1.00 per Private Warrant to CleanTech Investments, generating gross proceeds of \$675,000.

The amounts held in the Trust Account may only be used by CLAQ upon the consummation of a business combination, except that there can be released to CLAQ, from time to time, any interest earned on the funds in the Trust Account that it may need to pay its tax obligations. The remaining interest earned on the funds in the Trust Account will not be released until the earlier of the completion of a business combination and CLAQ's liquidation. CLAQ executed the Merger Agreement on December 16, 2021 and it must liquidate unless a business combination is consummated by July 19, 2022, the date that is 12 months from the closing of the IPO (or January 19, 2023, the date that is 18 months from the closing of the IPO, if the Combination Period is extended by the full amount of time allowed under CLAQ's Current Charter).

After deducting the underwriting discounts, offering expenses, and commissions from the IPO (including the over-allotment option) and the sale of the Private Warrants, a total of \$174,500,000 was deposited into the Trust Account, and the remaining \$1,500,000 of the net proceeds were outside of the Trust Account and made available to be used for business, legal and accounting due diligence on prospective business combinations and continuing general and administrative expenses.

As of March 31, 2022, CLAQ had \$296,381 cash outside the Trust Account available for its working capital needs. As of March 31, 2022, there was \$174,247,973 held in the Trust Account.

The Units, Common Stock, Rights and Warrants are currently listed on the Nasdaq Stock Market, under the symbols "CLAQU," "CLAQ," "CLAQR" and "CLAQW," respectively. The Units, Common Stock and Warrants commenced trading on the Nasdaq Stock Market separately on or about August 4, 2021.

CLAQ's principal executive offices are located at 207 West 25th Street, 9th Floor, New York, NY 10001 and its telephone number is (212) 494-9005.

Nauticus Robotics, Inc.

Nauticus Robotics, Inc. is a Houston-area developer of ocean robots, cloud software, and services delivered in a modern business model to the ocean industry. Nauticus was initially incorporated as Houston Mechatronics, Inc. on March 27, 2014, in the State of Texas. Nauticus' robotics products and services will be delivered to commercial and government-facing customers through a Robotics as a Service ("RaaS") business model and direct product sales for both hardware platforms and software licenses. Besides a standalone service offering and forward facing products, Nauticus' approach to ocean robotics has also resulted in the development of a range of technology products for retrofit/upgrading legacy systems and other 3rd party vehicle platforms. Nauticus' services provide customers with the necessary data collection, analytics, and subsea manipulation capabilities to support and maintain assets while reducing their operational footprint, operating cost, and greenhouse gas emissions, to improve offshore health, safety, and environmental exposure.

The Robotics as a Service revenue model emulates the Software as a Service (SaaS) revenue model, which is commonly used for consumer and business software licensing, but extends the model to include robots. In the SaaS model, the end user pays a fixed fee for a set period of time in order to use of the software. In the case of Nauticus' RaaS model, clients will be charged a flat fee for performing the service over a period of time as required to complete the task. This fixed fee supports full use of Aquanaut, Hydronaut, ToolKITT, the communication infrastructure, and the personnel required to support the servicing mission. The RaaS fee approach encompasses the complete technology stack that is required to complete the contracted work. This can be contrasted with the industry's current commercial approach which bills clients based on the individual elements for performing the servicing mission (e.g., an itemized invoice for deployment of the equipment, tooling, crew, boat fuel, vessel, etc.). With the RaaS model, a flat rate, currently estimated to be \$40,000/day, will be billed to cover all equipment and personnel required to perform the service, irrespective of exactly which tasks are being performed. In Nauticus' RaaS model, the subscriber pays for the service and not the rolled-up costs individually, as is frequently done today via an a la carte menu fashion. All other costs are covered in the subscription fee, including the long-term maintenance and servicing of the robots. At this stage, Nauticus proposes the use of a Robotics as a Service business model for delivering services to commercial clients only.

In contrast to the other robotics systems, the Argonaut is handled differently and does not currently fall under the RaaS business model. The client base for Argonaut purchases the platform outright. There is longer term service revenue associated with each platform around maintenance and add-on enhancements and payloads.

Nauticus' mission is to disrupt the current ocean services paradigm through the introduction and integration of advanced robotic technologies. These key technologies are supervised autonomy control software, novel robotic platforms capable of implementing autonomous behaviours, acoustic communications networking protocols, force/torque controllable electric manipulation, perception, artificial intelligence, and machine learning software, and multimodal 3-D workspace sensors. Implementation of these technologies enables substantially improved operations at significantly reduced costs and greenhouse gas emissions over conventional methods based on the size of legacy surface support vessels, their crew, and required communications and power links. Legacy surface support vessels are typically 75 meter vessels, requiring a large crew and substantial equipment. Further, using tethered ROVs, the surface support vessel must support large spools of communication and power cable that can link the surface to the ROV, for example, down to 3,000m. This outfit can cost upwards of \$100,000 per day, based on the size of the crew, the cost of the surface support vessel and equipment. In comparison, Nauticus' cost estimates, which it validated through testing of the Hydronaut and Aquanaut, show that these day rate costs can be reduced by up to 60% when the full complement of Nauticus technologies are deployed. This is because the cost to outfit and hire the vessel are reduced as the Hydronaut is a 18 meter vessel, requiring fewer crew and resources. And, the reduced crew and vessel size leads to similar reductions in greenhouse gases emitted during these operations. Further, because the Aquanaut is an untethered remotely operated vehicle ("ROV"), it does not require the amounts of communication and power cables that a tethered ROV requires, reducing the cost of operations.

Robotics Systems:

A sample set of Nauticus' portfolio of robotics systems include:

- ***Aquanaut.*** The Aquanaut is designed to be launched from shore or off the back of an autonomous surface vessel to operate as a free-swimming subsea vehicle that is controlled through an acoustic communication system and capable of performing a wide range of inspection and manipulation tasks. The defining capability of Aquanaut is to operate in two separate modes — Inspection and Intervention. The Inspection mode involves the use of sensors during vehicle transit and the Intervention mode uses work class manipulators (Nauticus' Olympic Arms) to perform work in the subsea environment.

The Aquanaut is currently offered through direct sales to strategic clients and will be offered through RaaS when available.

Nauticus has produced two units to date. Both of which may be considered “pre-production units” but for internal purposes are distinguished as being a “developmental unit” and a “pre-production unit”. The initial unit, referred to herein as the “developmental unit” was built to identify the key developmental challenges (hence why the moniker “developmental unit” is sometimes used to refer to this initial vehicle) of building a transformable subsea vehicle that could perform dexterous manipulation over low-capacity bandwidth and latent communication techniques (i.e., those indicative of acoustic communications rates — to which Nauticus was granted a patent). Once the “developmental unit” was produced, Nauticus tested this vehicle in Nauticus’ own test tank, NASA’s indoor Neutral Buoyancy Laboratory, Seanic’s outdoor pool, and in other inland outdoor bodies of water to identify other design aspects for further engineering improvements.

This “developmental unit” vehicle testing motivated the redesign of subsystems for the subsequent Aquanaut vehicle, referred herein as the “pre-production unit” vehicle. Nauticus chose to apply the pre-production classification to the second unit because the vehicle still had not gone through a design evolution for deep water and mass production (defined as tens of units per year) considerations. However, the second pre-production vehicle still incorporated several key improvements over the initial “developmental unit” including aluminum space frame hull structure and other materials enhancements, improved thrust and sensor payloads, improved vehicle performance, and most importantly an improved power electronics and avionics architecture. The second “pre-production unit” vehicle also expanded the test regime to the Gulf of Mexico Galveston Bay area. The purpose of this second “pre-production unit” vehicle was to demonstrate expanded and advanced capabilities in perception, embedded computing, and autonomous manipulation and to further inform the manufacturing techniques for the production vehicles. The developmental unit is currently under contract with our Large Confidential Government Contractor (as defined below). The “generational” approach described above, that Nauticus has utilized in the development of the Aquanaut, is a very common engineering practice that mitigates final product risk through incremental vehicle improvements.

Three units are in production (which are being assembled through a trusted and experienced subsea vehicle manufacturing partner incorporating processes for tighter quality control, volume manufacturing that will allow repeatable low volume mass production and also some improved deep-water design changes) and are expected to be completed by the end of the third quarter of 2022. The current production timeline for a single Aquanaut is six months, but Nauticus expects that timeline to decrease to three months in coming years, with production efficiency gains and economies of scale. Nauticus expects that it will be able to sell, lease, or add to its commercial service fleet each Aquanaut within a maximum of 90 days of completed production.

- **Argonaut.** A derivative of the Aquanaut vehicle is the Argonaut which has enhanced capabilities for transit and autonomous operations. This vehicle has been orchestrated to provide Nauticus’ government-facing customers with the capabilities to perform their specialized mission scenarios. The Argonaut is completing final assembly in our facility. Upon completion, expected in the second quarter of 2022, the first Argonaut vehicle will undergo commissioning in the Gulf of Mexico leading to its acceptance by the customer, a large confidential government contractor (a “Large Confidential Government Contractor”), for further use in US government applications. Specifically, this vehicle will be used by a Large Confidential Government Contractor, in conjunction with Nauticus, to perform under a current contract. This product and other variants are already available for direct sales to U.S. Department of Defense entities, contractors, and is planned for future commercial services through a RaaS contract for ongoing services.

Since there is very little difference between Argonaut and Aquanaut except for the outer mold line (“OML”), and minor navigational and other sensors, the current production timeline for a single Argonaut is also six months. But Nauticus expects that timeline to similarly decrease to three months in coming years. Nauticus expects that it will be able to sell or lease an Argonaut within 90 days of completed production.

- **Olympic Arm.** An all-electric, work-class manipulator built to serve ROV and hovering and resident AUV markets, providing an electric advantage that allows for more perception-driven decision making for semi-autonomous tasking. The current existing hydraulic solutions are undesirable for both operating costs and environmental concerns. Fully electric systems that make use of advanced sensing and control

techniques will increase reliability and reduce time-on-task (vessel days saved). Further the all-electric architecture helps prevent hydraulic oil spills for the current offering for more environmentally sensitive areas. (e.g., North Sea, Canada, etc.).

The Olympic Arm is currently offered as both a standalone product and as a component to both the Aquanaut and in future models of the Argonaut. As such, the Olympic Arm is offered through direct sales and is planned for future commercial services through RaaS. As a standalone product, Nauticus is delivering the first unit to the first customer, IKM Subsea, in the second quarter of 2022, followed by a second unit to an additional customer by the end of the second quarter of 2022. The current production timeline for a single Olympic Arm is two months, but Nauticus expects that timeline to decrease to one month in coming years, with production efficiency gains. Nauticus expects that it will be able to sell or lease an Olympic Arm, or incorporate it into an existing product order, within 90 days of completed production.

- ***ToolKITT.*** This software suite is a multi-layered, multi-tool, software platform that can operate the Aquanaut, Argonaut, Olympic Arm, or other 3rd party ocean robotic vehicles through all mission phases. Its capabilities include navigational guidance, vehicle, and manipulator control as well as perception and planning and execution of tasks. ToolKITT is currently generating revenue through a Defense Innovation Unit contract. Under this contract, the ToolKITT operates and controls a 3rd party ROV called a VideoRay Defender (a “Defender ROV”) to perform a set of tasks in support of subsea defense operations. Upon the successful completion of this contract, Nauticus will have the opportunity to license ToolKITT to the U.S. Department of Defense for use on their existing fleet of Defender ROVs.
- ***Hydronaut.*** A small, optionally crewed autonomous surface vessel that will support the real-time operations of Aquanaut in long range and deep water commercial applications. Hydronaut will ferry Aquanaut to and from the worksite and support battery recharging and the over-the-horizons communications link to shore.

The first Hydronaut (“Hydronaut 1”) is currently fulfilling charter days for a Large Confidential Government Contractor, related to a Department of Defense customer. The lease agreement for Hydronaut 1 was based on a usage rate of \$6,000 per day, with no fixed number of operational days, beginning on January 31, 2022. Through the four months ended April 30, 2022, the vessel had only been utilized three (3) days for a total revenue of \$18,000. Hydronaut will support the RaaS model, when implemented, for Aquanaut. Nauticus will also independently offer Hydronaut through RaaS, when available, and currently offers Hydronaut through direct sales. Nauticus currently has one Hydronaut in service. It also has two more Hydronauts in production with Diverse Marine, in the UK, which are expected to be completed during the first quarter of 2023. Nauticus expects that it will be able to sell, lease, or add to its commercial service fleet, a Hydronaut within 90 days of completed production.

Robotics Team:

Nauticus has an experienced team with deep operational expertise in bringing emerging technologies to market. Nauticus’ engineering and design efforts are led by a highly experienced robotics team with over 200 years of cumulative robotics experience. Nauticus’ core engineering team has been working together for over 15 years and has designed and deployed advanced robotics systems for both public and private market applications.

Nauticus’ engineering process is a blend of Agile principles and a traditional phase-gate development workflows. The nature of robotics is highly intra- and multidisciplinary, containing both hardware and software components and requires a blend of both design methodologies. On the hardware side, Nauticus has created two design workflows (Standard Design and Simplified Design) that allow for quick-turn development as well as rigorous and detailed engineering work. Nauticus has also implemented a modified Agile Scrum workflow that allows for continual delivery of value, ability to change priorities, and resolve problems quickly.

Services and Revenue:

Nauticus is within an industry that operates on a service-based daily rate model, often with very lengthy master service agreements. These master service agreements can span from two to four years, or more, for each device dedicated to one customer, resulting in low utilization per asset. Nauticus differentiates itself by employing a more opportunistic view which expands across different customers for shorter periods of time, thus facilitating higher utilization rates.

However, similar to the current service model, our RaaS business model (planned for future commercial services but yet to be implemented) is characterized by a recurring revenue stream granted in exchange for services provided, in this case through usage of our Nauticus robotic vehicles. The RaaS model should be considered within a range of revenue models that have this recurring characteristic. The RaaS model, as described in this prospectus, covers a range of conventional service contracts through an ongoing contract to provide services in a local area. As Nauticus deploys its initial service fleet (currently projected to initially commence in late 2022, but really in force at the beginning of 2023) we anticipate that the initial services will be paid through conventional contracting methods, directly with the customer or in regional partnerships with an in-country service entity.

These conventional contracting methods typically revolve around a long-term master service agreement (MSA) with an end client and service company. As a go to market strategy, Nauticus Robotics aligned interests with regional partners (e.g., Stinger Technology AS in Norway) to offer this conventional method within already awarded frame agreements. This allows Nauticus Robotics to shorten the adoption time of the service technology solution to an end client without having the end client fully adopt the entire RaaS model. There is however nothing that would prevent the end client from contracting directly with Nauticus Robotics under the RaaS offering. Thus use of the conventional contracting method does not exclude the providing of such services through the RaaS business model. Nonetheless, this conventional contracting method provides a quicker alternative if the RaaS business model is initially undesirable — a prominent reason being that the current contract is not up for rebid until much later. This allows Nauticus Robotics to provide and the client to access Nauticus Robotics technology sooner. This in turn also allows Nauticus Robotics to rapidly expand into new regions since it will use the in-country facilities and business resources of the regional partner.

Nauticus' RaaS business model accommodates this type of contracting mechanism. However, as the new service paradigm matures and this technology is utilized by more customers, increased fleet assets will create a network effect in specific market regions (e.g., the North Sea, Gulf of Mexico, etc.). These assets will provide a continuous virtual residency of vehicles that serve the customer base. This 'residency' of available assets will enable a new approach to services at a further reduced cost, as customers share the operational overhead of supporting this new type of service infrastructure through ongoing subscription-based contracting.

The RaaS business model will be applied to the commercial fleet services aspect of our business. These services will be deployed through various RaaS contracting mechanisms as the market requires. The ToolKITT software platform is intended to be licensed on a SaaS basis or, in some cases, sold to end customers through a perpetual license. In the latter case, end users will be contracted for software support and maintenance. New versions and upgrades will be sold to customers set to retain the recurring revenue nature of the SaaS/RaaS model.

Although the sale of Nauticus' products may occur on either point sales or RaaS/SaaS models, the fleet services and software (ToolKITT) are targeted for this type of recurring revenue sales. Other products such as Argonaut (US Defense) and Olympic Arms (for existing ROVs) are anticipated to be sold through conventional sales contracts with accompanying software licenses. Aquanaut, the commercial subsea vehicle, may also be sold to selective customers, when those sales are not expected to cannibalize or compete with other Nauticus fleet services.

To date, Nauticus has generated revenue through U.S. defense contracts utilizing Aquanaut, Hydronaut, ToolKITT and commercial contracts for engineering services. A recent purchase order from IKM Group (Norway) marks the first commercial sale of Nauticus' Olympic Arm (all-electric, work class, subsea manipulator). The upcoming delivery of the Argonaut vehicle to a Large Confidential Government Contractor in the second quarter of 2022 represents the first sale of a vehicle to a commercial customer. Nauticus intends to continue to support the U.S. Department of Defense as a contract performer, both on its own and with a Large Confidential Government Contractor. These contracts support further technology development for Nauticus and further opportunities to migrate aspects of this work to the commercial sector. Both Nauticus and our partner, a Large Confidential Government Contractor, plan to actively pursue sales and services in the U.S. defense and intelligence communities through the Argonaut vehicle. Engineering services for ad hoc projects will be naturally phased out of the revenue mix as Nauticus focuses on deploying its service fleet and conducting subsea services.

Currently, the Nauticus has limited product sales as its core products are still under development. Product sales to date have been for HaloGuard, a red zone monitoring solution we developed.

The following table provides a breakdown of the actual and projected revenue by services and direct product sales⁽¹⁾⁽²⁾:

Category	2021A	2022E	2023E	2024E
Services	8.6	13.9	57.7	146.0
Direct Product Sales	0.0	9.5	36.8	56.1
Total	8.6	23.4	94.5	202.1

- (1) The projected revenue by Services and Direct Product Sales disclosed in the table above is subject to the same qualifications and assumptions applied to the revenue projections disclosed under “Proposal 1 — The Business Combination Proposal — Certain Nauticus’ Projected Financial Information”.
- (2) The projected revenue by Services and Direct Product Sales disclosed in the table above is the same that was presented and prepared as part of the projected financial information that Nauticus provided to CLAQ prior to its approval of the Business Combination.

The services reflected in the above table includes revenue from the RaaS model (as projected) applied to commercial services (primarily subsea energy/offshore wind), engineering services (primarily the Defense market), the lease of vehicles to commercial customers, and software licenses (SaaS). The Direct Product Sales category summarizes the sales of Aquanaut and Argonaut vehicles directly to commercial and defense customers.

The RaaS model is anticipated to fully commence in late 2022 after the delivery of additional vehicles to increase the fleet size and after their respective commissioning. Since the vehicles will have limited calendar space to generate revenue in 2022, the RaaS service model is expected to account for just a small portion, approximately \$0.35 million of the \$13.9 million, in the broader Services category (as defined above) revenue for 2022. These vehicles, along with the new builds projected in 2023, are expected to generate approximately \$12.6 million of the \$57.7 million Services revenue in 2023 with the balance of the revenue coming from the other services and product sales within government markets. In 2024, the service fleet is expected to expand and the revenue from the RaaS business is estimated to account for \$117.4 million of the total projected revenue of \$146.0 million from services.

Contact:

Nauticus’ principal executive offices are located at 17146 Feathercraft Lane, Suite 450, Webster, TX 77598. Nauticus’ telephone number in the USA is (281) 942-9069. Additional company and product information is available at www.nauticusrobotics.com.

For more information on Nauticus, please see the sections titled “Information about Nauticus Robotics, Inc.” and “Management’s Discussion and Analysis of Financial Condition and Results of Operations of Nauticus”

Merger Sub

Merger Sub is a wholly-owned subsidiary of CLAQ formed to consummate the Business Combination. Following the consummation of the Business Combination, Merger Sub will have merged with and into Nauticus, with Nauticus surviving the Merger as a wholly-owned subsidiary of CLAQ.

The Merger Agreement

On December 16, 2021, CLAQ, entered into an Merger Agreement with Merger Sub, and Nauticus. Pursuant to the terms of the agreement, a business combination between CLAQ and Nauticus will be effected through the merger of Merger Sub with and into Nauticus, with Nauticus surviving the Merger as a wholly owned subsidiary of CLAQ. On January 30, 2022, the Merger Agreement was amended to, among other things, (i) correct certain defined terms in the Merger Agreement; and (ii) include the cash available from the Debt Financing in meeting the “Minimum Cash Condition” defined in the Merger Agreement.

The Board of Directors of CLAQ (the “Board”) has (i) approved and declared advisable the Merger Agreement, the Business Combination and the other transactions contemplated thereby and (ii) resolved to recommend approval of the Merger Agreement and related matters by the stockholders of CLAQ.

On June 6, 2022, the Merger Agreement was amended to increase the aggregate number of shares of the Combined Company’s Common stock to be reserved for issuance pursuant to the Incentive Plan (defined below) from

5% to 10% of the fully diluted outstanding shares of its Common Stock after Closing, which share reserve shall be automatically increased on an annual basis by 3% of the total number of Common Stock outstanding as provided under the Incentive Plan.

The Merger Consideration

The Business Combination implies a \$561 million post-closing equity value and a current equity value of Nauticus at \$300 million. Prior to the Closing, Nauticus will (i) effect the Nauticus Preferred Stock Conversion, (ii) effect the Nauticus Convertible Notes Conversion, and (iii) convert each share of Nauticus Common Stock (including shares of Nauticus Common Stock outstanding as a result of the Nauticus Preferred Stock Conversion and Nauticus Convertible Notes Conversion, but excluding shares of the holders who perfect rights of appraisal under Delaware law) into the right to receive (a) the Per Share Merger Consideration and (b) Earnout Shares. As a result of these transactions, each outstanding share of Nauticus Common Stock will have a value at the time of the Business Combination of \$10.00 (based on the \$300 million equity value of Nauticus).

In addition, in connection with the Closing, CLAQ will issue the Earn-Out Shares to the former holders of Nauticus Common Stock and such holders will deliver the Earnout-Out Shares to the Escrow Agent. The release of the Earn-Out Shares to the former holders of Nauticus Common Stock will be subject to restrictions linked to milestones (based on the achievement of certain target prices of CleanTech Common Stock following the Closing) as further described in the section entitled “*Proposal 1 — The Business Combination Proposal — The Merger Agreement — Treatment of Nauticus Securities — Earn-Out Shares.*” In the event such milestones are not met, all of the Earn-Out Shares will be automatically released to CleanTech for cancellation and the former holders of Nauticus Common Stock shall not have any right to receive such Earnout Shares or any benefit therefrom.

Treatment of Nauticus Securities

Preferred Stock. Immediately prior to the Effective Time, each share of Nauticus Preferred Stock that is issued and outstanding immediately prior to such time shall automatically convert into shares of Nauticus Common stock, par value \$0.01 per share (the “Nauticus Common Stock”), in accordance with its Certificate of Incorporation (collectively, the “Nauticus Preferred Stock Conversion”). As a result of the Merger, an aggregate of 15,062,524 shares of CLAQ Common Stock will be issued to the holders of Nauticus Preferred Stock.

Convertible Notes. Immediately prior to the Effective Time, each of (i) that certain Unsecured Convertible Promissory Note, dated June 19, 2021, by and between Goradia Capital, LLC and Nauticus, as amended on December 16, 2021, (ii) that certain Unsecured Convertible Promissory Note, August 3, 2021, by and between Material Impact Fund II, L.P. and Nauticus, as amended on December 16, 2021, (iii) that certain Unsecured Convertible Promissory Note, dated October 22, 2021, by and between In-Q-Tel, Inc. and Nauticus, as amended on December 16, 2021, (iv) that certain Unsecured Convertible Promissory Note, dated July 28, 2020, by and between Schlumberger Technology Corporation and Nauticus, as amended on December 16, 2021, and (v) that certain Unsecured Convertible Promissory Note, dated December 7, 2020, by and between Transocean Inc. and Nauticus, as amended on December 16, 2021 (each, a “Nauticus Convertible Note” and collectively, the “Nauticus Convertible Notes”) shall automatically convert into shares of Nauticus Common Stock in accordance with the terms of each such Nauticus Convertible Note (collectively, the “Nauticus Convertible Notes Conversion”). As a result of the Merger, an aggregate of 5,299,543 shares of CLAQ Common Stock will be issued to the holders of Nauticus Convertible Notes.

Common Stock. At the Effective Time, following the Nauticus Preferred Stock Conversion and Nauticus Convertible Notes Conversion, each share of Nauticus Common Stock (including shares of Nauticus Common Stock outstanding as a result of the Nauticus Preferred Stock Conversion and Nauticus Convertible Notes Conversion, but excluding shares of the holders of which perfect rights of appraisal under Delaware law) will be converted into the right to receive the Per Share Merger Consideration (as defined below) and the Earnout Shares (as defined below). As a result of the Merger, an aggregate of 9,669,216 shares of CLAQ Common Stock will be issued to the holders of Nauticus Common Stock (not including the Earnout Shares).

Stock Options. At the Effective Time, each outstanding option to purchase shares of Nauticus Common Stock (a “Nauticus Option”), whether or not then vested and exercisable, will be assumed by CLAQ and converted automatically (and without any required action on the part of such holder of outstanding option) into an option to purchase shares of the CLAQ’s Common Stock equal to the number of shares determined by multiplying the number of shares of the Nauticus Common Stock subject to such Nauticus Option immediately prior to the Effective Time by the Exchange Ratio (as defined below), which product shall be rounded down to the nearest whole number of shares, at a

per share exercise price determined by dividing the per share exercise price of such Nauticus Option immediately prior to the Effective Time by the Exchange Ratio. As a result of the Merger, an aggregate of 3,977,368 shares of CLAQ Common Stock will be issuable upon exercise of these options.

Earnout Shares. Following the closing of the merger, former holders of shares of Nauticus Common Stock (including shares received as a result of the Nauticus Preferred Stock conversion and the Nauticus Convertible Notes conversion, the “Stockholder Earnout Group”) shall be entitled to receive their pro rata share of up to 7,500,000 additional shares of CleanTech Common Stock (the “Earnout Shares”). The Earnout Shares will be released and delivered to the Stockholder Earnout Group upon occurrence of the following (each, a “Triggering Event”):

(i) one-half of the Escrow Shares will be released if, within a 5-year period following the signing date of the Merger Agreement, the volume-weighted average price of the Combined Company Common Stock equals or exceeds \$15.00 per share, over any 20 trading days within a 30-day trading period;

(ii) one-quarter of the Escrow Shares will be released if, within a 5-year period following the signing date of the Merger Agreement, the volume-weighted average price of the Combined Company Common Stock equals or exceeds \$17.50 per share over any 20 trading days within a 30-day trading period; and

(iii) one-quarter of the Escrow Shares will be released if, within a 5-year period following the signing date of the Merger Agreement, the volume-weighted average price of the Combined Company Common Stock equals or exceeds \$20.00 per share over any 20 trading days within a 30-day trading period.

Representations and Warranties

The Merger Agreement contains customary representations and warranties of the parties thereto with respect to, among other things, (a) entity organization, good standing and qualification, (b) capital structure, (c) authorization to enter into the Merger Agreement, (d) compliance with laws and permits, (e) taxes, (f) financial statements and internal controls, (g) real and personal property, (h) material contracts, (i) environmental matters, (j) absence of changes, (k) employee matters, (l) litigation, and (m) brokers and finders.

Covenants

The Merger Agreement includes customary covenants of the parties with respect to operation of their respective businesses prior to consummation of the Merger and efforts to satisfy conditions to consummation of the Merger. The Merger Agreement also contains additional covenants of the parties, including, among others, covenants providing for CleanTech and Nauticus to use reasonable best efforts to cooperate in the preparation of the Registration Statement and Proxy Statement (as each such term is defined in the Merger Agreement) required to be filed in connection with the Merger and to obtain all requisite approvals of their respective stockholders including, in the case of CleanTech, approvals of the restated certificate of incorporation, the share issuance under Nasdaq rules and the omnibus incentive plan. CleanTech has also agreed to include in the Proxy Statement the recommendation of its board that stockholders approve all of the proposals to be presented at the special meeting.

Nauticus Robotics, Inc. Incentive Plan

CleanTech has agreed to approve and adopt a 2022 omnibus incentive plan (the “Incentive Plan”) to be effective as of the Closing and in a form mutually acceptable to CleanTech and Nauticus. The Incentive Plan shall provide for an initial aggregate share reserve equal to 10% of the number of shares of CleanTech Common Stock on a fully diluted basis at the Closing. Subject to approval of the Incentive Plan by the CleanTech’s stockholders, CleanTech has agreed to file a Form S-8 Registration Statement with the SEC following the Effective Time with respect to the shares of CleanTech Common Stock issuable under the Incentive Plan.

Non-Solicitation Restrictions

Each of CleanTech and Nauticus has agreed that from the date of the Merger Agreement to the Effective Time or, if earlier, the valid termination of the Merger Agreement in accordance with its terms, it will not initiate any negotiations with any party, or provide non-public information or data concerning it or its subsidiaries to any party relating to an Acquisition Proposal or Alternative Transaction (as such terms are defined in the Merger Agreement) or enter into any agreement relating to such a proposal. Each of CleanTech and Nauticus has also agreed to use its reasonable best efforts to prevent any of its representatives from doing the same.

Conditions to Closing

The consummation of the Merger is conditioned upon, among other things, (i) receipt of the CleanTech stockholder approval and Nauticus stockholder approval, (ii) the expiration or termination of the waiting period under the Hart-Scott-Rodino Antitrust Improvements Act of 1976, as amended, (iii) the absence of any governmental order, statute, rule or regulation enjoining or prohibiting the consummation of the Transactions, (iv) the effectiveness of the Registration Statement under the Securities Act, (v) CleanTech having at least \$5,000,001 of net tangible assets (as determined in accordance with Rule 3a51-1(g)(1) of the Securities Exchange Act of 1934, as amended (the “Exchange Act”)), (vi) solely with respect to CleanTech, (A) the representations and warranties of Nauticus being true and correct to applicable standards applicable and each of the covenants of Nauticus having been performed or complied with in all material respects and (B) the approval of the conversion of the convertible notes and (vii) solely with respect to Nauticus, (A) the representations and warranties of CleanTech being true and correct to applicable standards applicable and each of the covenants of CleanTech having been performed or complied with in all material respects (B) the receipt of the approval for listing by Nasdaq of the shares of CleanTech Common Stock to be issued in connection with the transactions contemplated by the Merger Agreement, (C) the effective resignations of certain directors and executive officers of CleanTech, (D) the amount of Minimum Cash Condition (as defined in the Merger Agreement) being equal to or exceeding \$50,000,000.

Termination

The Merger Agreement may be terminated at any time prior to the Effective Time as follows:

- (i) by mutual written consent of CleanTech and Nauticus;
- (ii) by either CleanTech or Nauticus if the other party has breached its representations, warranties, covenants or agreements in the Merger Agreement such that the conditions to closing cannot be satisfied and such breach cannot be cured within certain specified time periods, provided that the party seeking to breach is not itself in breach of the Merger Agreement;
- (iii) by either CleanTech or Nauticus if the transactions are not consummated on or before June 30, 2022, provided that the failure to consummate the transaction by that date is not due to a material breach by the party seeking to terminate and which such breach is the proximate cause for the conditions to close not being satisfied;
- (iv) by either CleanTech or Nauticus if a governmental entity shall have issued a law or final, non-appealable governmental order, rule or regulation permanently enjoining or prohibiting the consummation of the Merger, provided that, the party seeking to terminate cannot have breached its obligations under the Merger Agreement and such breach has proximately contributed to the governmental action;
- (v) by either CleanTech or Nauticus if the CleanTech stockholders do not approve the Merger Agreement at a meeting held for that purpose;
- (vi) by written notice from CleanTech to Nauticus if the Nauticus stockholders do not approve the Merger Agreement due to the failure of Nauticus to hold a stockholder vote; or
- (vii) by written notice from Nauticus to CleanTech if the CleanTech board shall have publicly withdrawn, modified or changed in an adverse manner its recommendation to vote in favor of the merger and other proposals.

The Merger Agreement and other agreements described below have been included to provide investors with information regarding their respective terms. They are not intended to provide any other factual information about CleanTech, Nauticus or the other parties thereto. In particular, the assertions embodied in the representations and warranties in the Merger Agreement were made as of a specified date, are modified or qualified by information in one or more confidential disclosure letters prepared in connection with the execution and delivery of the Merger Agreement, may be subject to a contractual standard of materiality different from what might be viewed as material to investors, or may have been used for the purpose of allocating risk between the parties. Accordingly, the representations and warranties in the Merger Agreement are not necessarily characterizations of the actual state of facts about CleanTech, Nauticus or the other parties thereto at the time they were made or otherwise and should only be read in conjunction with the other information that CleanTech makes publicly available in reports, statements and other documents filed with the SEC. CleanTech and Nauticus investors and securityholders are not third-party beneficiaries under the Merger Agreement.

Certain Related Agreements

Support Agreements. In connection with the execution of the Merger Agreement, CleanTech Sponsor I LLC and CleanTech Investments, LLC (each, a “Sponsor,” and collectively, the “Co -Sponsors”) entered into a support agreement (the “Sponsor Support Agreement”) with Nauticus pursuant to which the Sponsors have agreed to vote all shares of CleanTech Common Stock beneficially owned by them in favor of the Merger.

In addition, in connection with the execution of the Merger Agreement, certain stockholders of Nauticus owning approximately 88.8% of the voting power of Nauticus entered into a support agreement (the “Nauticus Support Agreement”) with CleanTech and Nauticus pursuant to which the stockholders agreed to vote all shares of Nauticus beneficially owned by them in favor of the Merger.

Subscription Agreements. In connection with the execution of the Merger Agreement, CleanTech entered into subscription agreements (collectively, the “Subscription Agreements”) with certain parties subscribing for shares of CleanTech Common Stock (the “Subscribers”) pursuant to which the Subscribers have agreed to purchase, and CleanTech has agreed to sell to the Subscribers, an aggregate of 3,530,000 shares of CleanTech Common Stock, for a purchase price of \$10.00 per share and an aggregate purchase price of \$35.3 million (the “Equity Financing”). The obligations to consummate the transactions contemplated by the Subscription Agreements are conditioned upon, among other things, customary closing conditions and the consummation of the transactions contemplated by the Merger Agreement.

Securities Purchase Agreement. In connection with the execution of the Merger Agreement, CleanTech and Nauticus entered into Securities Purchase Agreement with certain investors purchasing up to an aggregate of \$40.0 million in principal amount of secured debentures (the “Debentures”) and warrants. The number of shares of common stock into which the Debentures are convertible is equal to 120% of the outstanding principal amount of the Debentures divided by the conversion price of \$15.00, and the number of shares of common stock into which the associated warrants are exercisable is equal to 120% of the outstanding principal amount of the Debentures divided by the conversion price, with an exercise price equal to \$20, subject to adjustment (the “Debt Financing,” and together with the Equity Financing, the “PIPE Investment”). The exercise price of the associated warrant will be subject to (i) customary anti-dilution adjustments; and (ii) in the case of a subsequent equity sale at a per share price below the exercise price, the exercise price of the associated warrant will be adjusted to such lower price, and the number of shares underlying the warrant will increase proportionately. In the event of a rights offering or dividend, the warrant holder will be treated as though the shares underlying the warrant he/she holds were outstanding. These warrants can be exercised on a cashless basis. There will be an original issue discount of 2% from the issued amount of the Debentures. Interest will accrue on all outstanding principal amount of the Debentures at 5% per annum, payable quarterly. The Debentures will be secured by first priority interests, and liens on, all present and after-acquired assets of the Combined Company, and will mature on the fourth anniversary of the date of issuance. As of the date of this proxy statement/prospectus, ATW is the only purchaser and has subscribed for Debentures in the aggregate principal amount of \$37,959,184 (out of the aggregate \$40.0 million) which is convertible into 3,036,735 shares of the Combined Company’s common stock and associated warrants for an additional 3,036,735 shares of the Combined Company. ATW is managed by ATW Partners Opportunities Management, LLC, which is an affiliate of Chardan Capital Markets, LLC (“Chardan”), and our director, Mr. Jonas Grossman, is the Managing Partner and President of Chardan. Chardan will not receive any fees or compensation for ATW’s participation in the Debt Financing. The obligations to consummate the transactions contemplated by the Securities Purchase Agreement are conditioned upon, among other things, (i) raising \$25,000,000 in equity financing from strategic investors, (ii) hiring a chief financial officer with public company experience, and (iii) all conditions precedent to the Merger set forth in the Merger Agreement having been satisfied or waived. The Equity Financing will satisfy the closing condition related to the equity financing requirement for the Debt Financing, and the PIPE Investment alone will satisfy the Minimum Cash Condition under the Merger Agreement. Mr. Rangan Padmanabhan, Nauticus’ current CFO will be the CFO of the Company effective as of the date of the merger, satisfying the closing condition related to the hiring of a CFO with public company experience requirement for the Debt Financing.

Amended and Restated Registration Rights Agreement. In connection with the Closing, Nauticus, CleanTech and certain stockholders of each of Nauticus and CleanTech who will receive shares of CleanTech Common Stock pursuant to the Merger Agreement, will enter into an amended and restated registration rights agreement (“Registration Rights Agreement”) mutually agreeable to CleanTech and Nauticus, which will become effective upon the consummation of the Merger.

Lock-up Agreement and Arrangements. In connection with the Closing, the Sponsors and certain Nauticus stockholders will enter into a lock-up agreement (the “Sponsor Lock-Up Agreement” and “Company Stockholder Lock-up Agreement”) with Nauticus and CleanTech, pursuant to which each will agree, subject to certain customary exceptions, not to:

- (i) offer, sell, contract to sell, pledge or otherwise dispose of, directly or indirectly, any shares of CleanTech Common Stock received as merger consideration and held by it immediately after the Effective Time (the “Lock-Up Shares”), or enter into a transaction that would have the same effect;
- (ii) enter into transaction that would have the same effect, or enter into any swap, hedge or other arrangement that transfers, in whole or in part, any of the economic consequences of ownership of any of such shares, whether any of these transactions are to be settled by delivery of such shares, in cash or otherwise; or
- (iii) publicly disclose the intention to make any offer, sale, pledge or disposition, or to enter into any transaction, swap, hedge or other arrangement, or engage in any “Short Sales” (as defined in the Sponsor Lock-Up Agreement and Company Stockholder Lock-up Agreement) with respect to any security of CleanTech;

during a “Lock-Up Period” under their respective agreements.

Under the Sponsor Lock-up Agreement, the Lock-Up period means the period commencing on the Closing Date and ending on the earlier of (x) the one year anniversary of the Closing Date; (y) the date on which the volume weighted average price of shares of common stock equals or exceeds \$13.00 per share for twenty (20) of any thirty (30) consecutive trading days commencing after the Closing on Nasdaq, and (z) the date specified in a written waiver duly executed by Nauticus; provided that the restrictions set forth in the Sponsor Lock-up Agreement do not apply to (1) transfers or distributions to such stockholder’s current or former general or limited partners, managers or members, stockholders, other equity holders or direct or indirect affiliates (within the meaning of Rule 405 under the Securities Act of 1933, as amended) or to the estates of any of the foregoing; (2) transfers by bona fide gift to a member of the stockholder’s immediate family or to a trust, the beneficiary of which is the stockholder or a member of the stockholder’s immediate family for estate planning purposes; (3) by virtue of the laws of descent and distribution upon death of the stockholder; or (4) pursuant to a qualified domestic relations order, in each case where such transferee agrees to be bound by the terms of the Sponsor Lock-up Agreement.

Under the Company Lock-up Agreement, the Lock-Up period means the period commencing on the Closing Date and ending on the earlier of (x) the date that is 180 calendar days after the consummation of the Business Combination, (y) the date on which the volume weighted average price of shares of common stock equals or exceeds \$13.00 per share for twenty (20) of any thirty (30) consecutive trading days commencing after the Closing on Nasdaq, and (z) the date specified in a written waiver duly executed by the Sponsors and CleanTech; provided that the restrictions set forth in the Company Lock-up Agreement do not apply to (1) transfers or distributions to such stockholders current or former general or limited partners, managers or members, stockholders, other equityholders or other direct or indirect affiliates (within the meaning of Rule 405 under the Securities Act of 1933, as amended) or to the estates of any of the foregoing; (2) transfers by bona fide gift to a member of the stockholder’s immediate family or to a trust, the beneficiary of which is the stockholder or a member of the stockholder’s immediate family for estate planning purposes; (3) by virtue of the laws of descent and distribution upon death of the stockholder; (4) pursuant to a qualified domestic relations order, in each case where such transferee agrees to be bound by the terms of this Agreement; (5) transfers or distributions of, or other transactions involving, securities other than the Lock-up Shares (including, without limitation, securities acquired in the PIPE or in open market transactions); or (6) in the case of Angela Berka (or Reginald Berka with respect to any community, marital or similar interest he may have in the following shares), the transfer of up to 1,000,000 shares of Lock-up Shares in a privately negotiated sale to another company stockholder, who shall enter into a Lock-Up Agreement (or amend an existing Lock-Up Agreement) containing the same terms and conditions as this Agreement with respect to such shares, or the entry into any agreement with respect to such a sale entered into before, at or after the Effective Time.

Director Nomination Agreement. In connection with the Closing, CleanTech, the Sponsors and Nauticus will enter into a Director Nomination Agreement (the “Director Nomination Agreement”) pursuant to which CleanTech will agree to nominate Eli Spiro, an individual designated by the Sponsors to the Board of Directors of the combined company, effective as of immediately prior to the Closing.

Director Designation Agreement. In connection with the execution of the Merger Agreement, CleanTech, Nauticus and certain Nauticus stockholders entered into a director designation agreement with Transocean, Inc. (“Transocean”) to take all necessary action to cause a member designated by Transocean (the “Transocean Designee”)

to remain on, or otherwise be appointed to, the Board, from and after the effective time of the Merger, as a Class III member of the Board, for an initial term expiring at the third annual meeting following the date of the Second Amended and Restated Certificate of Incorporation to be adopted in connection with the Merger.

Indemnification Agreements. In connection with the Closing, CleanTech has agreed to enter into customary indemnification agreements, in form and substance reasonably acceptable to CleanTech and Nauticus, with the individuals who will be nominated and, subject to stockholder approval, elected to CleanTech's board of directors effective as of the Closing.

Management

Effective as of the closing of the Business Combination, all of the executive officers of CLAQ immediately prior to the closing of the Business Combination shall resign and the individuals serving as executive officers of the Combined Company immediately after the closing the Business Combination will be the same individuals (in the same offices) as those of Nauticus immediately prior to the closing of the Business Combination.

See "Directors and Executive Officers of the Combined Company after the Business Combination" for additional information.

Voting Securities

As of the Record Date, there were _____ shares of common stock issued and outstanding. Only CLAQ stockholders who hold shares of common stock of record as of the close of business on _____, 2022 are entitled to vote at the Meeting or any adjournment thereof. Approval of the Business Combination Proposal, the Stock Plan Proposal, the Nasdaq Merger Proposal, the Nasdaq PIPE Proposal, and the Adjournment Proposal will each require the affirmative vote of the holders of a majority of the issued and outstanding shares of common stock present in person by virtual attendance or represented by proxy and entitled to vote at the Meeting or any adjournment thereof. Approval of the Charter Approval Proposal will require the affirmative vote of a majority of the issued and outstanding shares of common stock. Approval of the Directors Proposal will require the plurality of votes cast.

Attending the Meeting either in person by virtual attendance or by submitting your proxy and abstaining from voting will have the same effect as voting against all the Proposals and, assuming a quorum is present, broker non-votes will have no effect on the Proposals, other than the Charter Approval Proposal, for which it will have the same effect as voting against the Proposal.

With respect to the Business Combination, pursuant to the Letter Agreement, the Initial Stockholders holding an aggregate of 4,312,500 shares (or 20.0% of the outstanding shares) of common stock have agreed to vote their shares of common stock in favor of the Business Combination Proposal. Pursuant to the Sponsor Support Agreement, the Co-Sponsors holding an aggregate of 4,032,500 shares of common stock have agreed to vote their shares in favor of each of the Business Combination Proposal. As a result, only 1,078,126 shares of common stock held by the public stockholders will need to be present in person by virtual attendance or by proxy to satisfy the quorum requirement for the meeting. In addition, as the vote to approve the Business Combination Proposal is a majority of the votes cast at a meeting at which a quorum is present, assuming only the minimum number of shares of common stock to constitute a quorum is present, only 539,063 shares of common stock, or approximately 3.1% of the outstanding shares of the common stock held by the public stockholders must vote in favor of the Business Combination Proposal for it to be approved.

Appraisal Rights

Appraisal rights are not available to holders of shares of common stock in connection with the proposed Business Combination under Delaware law.

Redemption Rights

Pursuant to CLAQ's Certificate of Incorporation, holders of Public Common Stock may elect to have their shares redeemed for cash at the applicable redemption price per share equal to the quotient obtained by dividing (i) the aggregate amount on deposit in the trust account as of two business days prior to the consummation of the Business Combination, including interest (net of taxes payable), by (ii) the total number of then-outstanding Public Common Stock. As of _____, 2022, this would have amounted to approximately \$10.10 per share.

You will be entitled to receive cash for any Public Common Stock to be redeemed only if you:

- (i) (a) hold Public Common Stock, or
 - (b) hold Public Common Stock through Units and you elect to separate your Units into the underlying Public Common Stock prior to exercising your redemption rights with respect to the Public Common Stock; and
- (ii) prior to _____, Eastern Time, on _____, 2022, (a) submit a written request to Continental that CLAQ redeem your Public Common Stock for cash and (b) deliver your Public Common Stock to Continental, physically or electronically through DTC.

Holders of outstanding Units must separate the underlying Public Common Stock prior to exercising redemption rights with respect to the Public Common Stock. If the Units are registered in a holder’s own name, the holder must deliver the certificate for its Units to Continental, with written instructions to separate the Units into their individual component parts. This must be completed far enough in advance to permit the mailing of the certificates back to the holder so that the holder may then exercise his, her or its redemption rights upon the separation of the Public Common Stock from the Units.

If a holder exercises his/her redemption rights, then such holder will be exchanging his/her Public Common Stock for cash and will no longer own shares of the Combined Company. Such a holder will be entitled to receive cash for its Public Common Stock only if it properly demands redemption and delivers its Public Common Stock (either physically or electronically) to Continental in accordance with the procedures described herein. Please see the section titled “*The Meeting — Redemption Rights*” for the procedures to be followed if you wish to redeem your Public Common Stock for cash.

Ownership of the Post-Business Combination Company After the Closing

It is anticipated that upon completion of the Business Combination and assuming no redemptions by CLAQ public stockholders, CLAQ’s public stockholders (other than the Equity Financing investors) will retain an ownership interest of approximately 28.5% in the Combined Company the Equity Financing investors will own approximately 5.6% of the Combined Company, the Co-Sponsors, officers, directors and other holders of founder shares will retain an ownership interest of approximately 6.8% of the Combined Company, and the Nauticus stockholders will own approximately 59.1% (including the 7,500,000 Earnout Shares) of the Combined Company.

The following tables illustrate estimated ownership levels in the Company, immediately following the consummation of the Business Combination, based on the varying levels of redemptions by CLAQ public stockholders and the following additional assumption:

	No Redemptions ⁽¹⁾		10% Redemption ⁽²⁾		50% Redemption ⁽³⁾		75% Redemption ⁽⁴⁾		Maximum Redemption ⁽⁵⁾	
		%		%		%		%		%
Nauticus stockholders ⁽⁶⁾	37,531,279	59.1%	37,531,279	60.8%	37,531,279	68.4%	37,531,279	74.3%	37,531,279	81.2%
CLAQ public stockholders ⁽⁷⁾	18,112,500	28.5%	16,387,500	26.5%	9,487,500	17.3%	5,175,000	10.2%	862,500	1.9%
Initial Stockholders ⁽⁸⁾	4,312,500	6.8%	4,312,500	7.0%	4,312,500	7.9%	4,312,500	8.5%	4,312,500	9.3%
PIPE Investment investors ⁽⁹⁾	3,530,000	5.6%	3,530,000	5.7%	3,530,000	6.4%	3,530,000	7.0%	3,530,000	7.6%
Pro forma common stock at March 31, 2022	63,486,279	100.0%	61,761,279	100.0%	54,861,279	100.0%	50,548,779	100.0%	46,236,279	100.0%
<i>Potential sources of dilution:</i>										
Public Warrants	8,625,000	13.6%	8,625,000	14.0%	8,625,000	15.7%	8,625,000	17.1%	8,625,000	18.7%
Private Warrants	7,175,000	11.3%	7,175,000	11.6%	7,175,000	13.1%	7,175,000	14.2%	7,175,000	15.5%
Nauticus Options	3,977,368	6.3%	3,977,368	6.4%	3,977,368	7.2%	3,977,368	7.9%	3,977,368	8.6%
Debentures	3,036,735	4.8%	3,036,735	4.9%	3,036,735	5.5%	3,036,735	6.0%	3,036,735	6.6%
Warrants	3,036,735	4.8%	3,036,735	4.9%	3,036,735	5.5%	3,036,735	6.0%	3,036,735	6.6%

- (1) Assumes that no CLAQ public stockholders are redeemed and excludes potential dilution from sources of dilution.
- (2) Assumes that 1,725,000 Public Common Stock is redeemed for aggregate redemption payments of approximately \$17,424,797, assuming a \$10.10 per share redemption price and based on funds in the Trust Account as of March 31, 2022. The Merger Agreement includes a condition to the closing that at the closing having an amount of available cash from the Trust Account and the PIPE Investment (after giving effect to the redemption of any Public Common Stock in connection with the IPO and the payment of the transaction expenses), of no less than \$50,000,000.
- (3) Assumes that 8,625,000 Public Common Stock is redeemed for aggregate redemption payments of approximately \$87,123,987, assuming a \$10.10 per share redemption price and based on funds in the Trust Account as of March 31, 2022. The Merger Agreement includes a condition to the closing that at the closing having an amount of available cash from the Trust Account and the Equity Financing (as defined in the Merger Agreement) (after giving effect to the redemption of any Public Common Stock in connection with the IPO and the payment of the transaction expenses), of no less than \$50,000,000.

- (4) Assumes that 12,937,500 Public Common Stock is redeemed for aggregate redemption payments of approximately \$130,685,980, assuming a \$10.10 per share redemption price and based on funds in the Trust Account as of March 31, 2022. The Merger Agreement includes a condition to the closing that at the closing having an amount of available cash from the Trust Account and the Equity Financing (as defined in the Merger Agreement) (after giving effect to the redemption of any Public Common Stock in connection with the IPO and the payment of the transaction expenses), of no less than \$50,000,000.
- (5) Assumes that 17,250,000 Public Common Stock is redeemed for aggregate redemption payments of approximately \$174,247,973, assuming a \$10.10 per share redemption price and based on funds in the Trust Account as of March 31, 2022. The Merger Agreement includes a condition to the closing that at the closing having an amount of available cash from the Trust Account and the PIPE Investment (after giving effect to the redemption of any Public Common Stock in connection with the IPO and the payment of the transaction expenses), of no less than \$50,000,000.
- (6) Includes 7,500,000 Earnout Shares subject to the Triggering Events. Such shares will be deposited into escrow in accordance with the terms of the Merger Agreement and will be subject to reduction or forfeiture in accordance with the terms of the Merger Agreement. However, registered holders will maintain voting rights related to such shares unless forfeited.
- (7) Excludes 8,625,000 Public Warrants and includes the issuance of 862,500 shares of Common Stock pursuant to the Rights. If all potential sources of dilution were exercised and converted into Common Stock the CLAQ public stockholders would hold approximately 20.3%, 18.7%, 11.8%, 6.8% and 1.2% under the No Redemptions, 10% Redemption, 50% Redemption, 75% Redemption, and Maximum Redemption scenarios, respectively. See “Risk Factors — Risks Related to CLAQ’s Business and the Business Combination — The CLAQ Public Stockholders will experience dilution as a consequence of, among other transactions, the issuance of Common Stock as consideration in the Business Combination and the PIPE Investment” for additional information related to the risk of dilution to our public stockholders.
- (8) Excludes 7,175,000 Private Warrants. If all potential sources of dilution were exercised and converted into Common Stock the Initial Stockholders would hold approximately 4.8%, 4.9%, 5.3%, 5.6% and 6.0% under the No Redemptions, 10% Redemption, 50% Redemption, 75% Redemption, and Maximum Redemption scenarios, respectively. See “Risk Factors — Risks Related to CLAQ’s Business and the Business Combination — The CLAQ Public Stockholders will experience dilution as a consequence of, among other transactions, the issuance of Common Stock as consideration in the Business Combination and the PIPE Investment” for additional information related to the risk of dilution to our public stockholders.
- (9) Total of 4,312,500 outstanding founder shares includes 1,437,500 founder shares held by the Sponsor, 2,595,000 founder shares held by CleanTech Investments, and 280,000 founder shares held by the officers and directors of CleanTech. Please see the section titled “Beneficial Ownership of Securities.”
- (10) Assumes the sale of an aggregate of 3,530,000 shares of CleanTech Common Stock, for a purchase price of \$10.00 per share and an aggregate purchase price of \$35,300,000. Excludes the dilution that could be caused by the conversion of the Debentures and Warrants issued pursuant to the Securities Purchase Agreement.

Additionally, in connection with the Business Combination, CLAQ plans to adopt a new Incentive Award Plan. Pursuant to the Merger Agreement, 10% of the aggregate number of shares of common stock issued and outstanding immediately after the consummation of the Business Combination may be granted to employees, non-employee directors and consultants. The total number of shares of common stock of the Combined Company that will be reserved and that may be issued under the Incentive Award Plan will automatically increase on the first trading day of each calendar year, beginning with calendar year 2023, by a number of shares equal to three percent (3%) of the total number of shares of common stock of the Combined Company outstanding on the last day of the prior calendar year.

Pursuant to a Business Combination Marketing Agreement with Chardan Capital Markets, LLC (“Chardan”), CLAQ has agreed to pay Chardan a marketing fee of \$6,037,500, representing 3.5% of the gross proceeds received from CLAQ’s IPO, for holding meetings with the stockholders to discuss the potential Business Combination and the target business’s attributes, introducing CLAQ to potential investors that are interested in purchasing the securities in connection with the potential Business Combination, assisting CLAQ in obtaining stockholder approval for the Business Combination and assisting CLAQ with press releases and public filings in connection with the Business Combination. The marketing fee will be payable after the closing of the Business Combination. Additionally, pursuant to a Financial Advisory Agreement with Chardan, CLAQ has agreed to pay Chardan a placement fee of \$2,118,000, representing 6.0% of the gross proceeds received from the PIPE Investment that is not sold to an affiliate of Chardan, for certain financial advisory services. The placement fee will be payable at the closing of the PIPE Investment.

In order to broaden CLAQ and Nauticus’ reach to additional potential investors, parties interviewed a number of investment banks. After having considered the relative strengths and customer bases of different investment banks and advisory services providers, parties entered into letter agreements with four investment banks for their capital markets and financial advisory services between February and April 2022. None of these four investment banks are affiliated with CLAQ, its officers and directors or any of their affiliates. Pursuant to a letter agreement dated February 11, 2022 with Roth Capital Partners, LLC (“Roth”), CLAQ has agreed to pay Roth a cash advisory fee of \$350,000 following the closing of the Business Combination during the term of the agreement or within six months following any termination of the agreement, in return for Roth’s capital markets advisory services which include, among other

things, (i) providing advice and assistance to CLAQ regarding defining objectives and potential equity offerings (including with respect to structure, marketing strategy and execution); (ii) assisting the evaluation of CLAQ's equity securities; and (iii) performing analyses of equity capital markets and shareholder engagement. The term of the agreement with Roth shall continue until terminated by either party. Pursuant to a letter agreement dated February 28, 2022 with Lake Street Capital Markets ("Lake Street"), CLAQ and Nauticus have agreed that the Combined Company will pay Lake Street a non-refundable retainer of \$350,000 within ten days following the closing of the Business Combination in return for Lake Street's capital markets advisory services which include, among other things, (i) providing advice and assistance to CLAQ in evaluating its capital raising strategies and alternatives; (ii) assisting CLAQ in refining and communicating its investor presentation; and (iii) working and coordinating with CLAQ's investors relations resources to conduct a non-deal investor roadshow in the U.S. and solicit, and analyze investors' feedback. The term of the agreement with Lake Street shall expire on the earlier of (a) February 28, 2023, or (b) the closing of the Business Combination. Pursuant to a letter agreement dated March 23, 2022 with Cowen and Company, LLC ("Cowen"), Nauticus has agreed to pay Cowen an advisory fee of \$1,750,000 (the "Business Combination Fee") upon closing of the Business Combination in return for Cowen's capital market advisory services which include, among other things, (i) familiarizing itself with the business, properties and operation of each of CLAQ and Nauticus; (ii) advising Nauticus on investor outreach, assisting Nauticus in scheduling and arranging meetings with current and potential holders of its securities; and (iii) assisting Nauticus in formulating a marketing strategy for the Business Combination. If this agreement with Cowen is terminated, the Business Combination Fee will still be payable if a business combination is consummated within twelve months from the date of the termination of the agreement (the "Residual Period"). If during the term of this agreement with Cowen or the Residual Period, Nauticus proposes to effect any restructuring, acquisition or disposition, or certain sales of securities, Nauticus has agreed to engage Cowen and offer Cowen no less than 35% of the total economics for any such capital raising transaction. Pursuant to an amended and restated letter agreement dated April 25, 2022 with Coastal Equities, Inc. ("Coastal"), Nauticus has agreed to pay Coastal a cash fee of \$7,600,000 ("Cash Fee") upon closing of the Business Combination or any other transaction defined as a "Sale" of Nauticus pursuant to the letter agreement in return for Coastal's financial advisory services which include, among other things, (i) facilitating potential purchasers' or financing participants' due diligence investigation; (ii) performing valuation analyses; (iii) identifying opportunities for the Sale of Nauticus; and (iv) as requested by Nauticus, participating on Nauticus' behalf in negotiations concerning such Sale. If this letter agreement with Coastal is terminated, the Cash Fee will still be payable if the Sale of Nauticus occurs within 9 months from March 29, 2022, the effective date of the letter agreement.

The following table illustrates the amounts and form of capital market and financial advisory fees payable from trust proceeds at each redemption level identified below:

	No Redemptions	10% Redemption	50% Redemption	75% Redemption	Maximum Redemption
Unredeemed public shares	18,112,500	16,387,500	9,487,500	5,175,000	862,500
Trust proceeds to Nauticus	\$ 174,230,428	\$ 156,807,385	\$ 87,115,214	\$ 43,557,607	\$ —
PIPE Investment	\$ 72,500,000	\$ 72,500,000	\$ 72,500,000	\$ 72,500,000	\$ 72,500,000
Business Combination Marketing Agreement – Chardan	\$ 6,037,500	\$ 6,037,500	\$ 6,037,500	\$ 6,037,500	\$ 6,037,500
Financial Advisory Agreement – Chardan	\$ 2,118,000	\$ 2,118,000	\$ 2,118,000	\$ 2,118,000	\$ 2,118,000
Amended and Restated Financial Advisory Agreement – Coastal	\$ 7,600,000	\$ 7,600,000	\$ 7,600,000	\$ 7,600,000	\$ 7,600,000
Capital Market Advisory Agreement – Roth	\$ 350,000	\$ 350,000	\$ 350,000	\$ 350,000	\$ 350,000
Capital Market Advisory Agreement – Lake Street	\$ 350,000	\$ 350,000	\$ 350,000	\$ 350,000	\$ 350,000
Capital Market Advisory Agreement – Cowen	\$ 1,750,000	\$ 1,750,000	\$ 1,750,000	\$ 1,750,000	\$ 1,750,000
Effective fee (%)	7.38%	7.94%	11.41%	15.69%	25.11%

SUMMARY UNAUDITED PRO FORMA CONDENSED COMBINED AND CONSOLIDATED FINANCIAL INFORMATION

The following summary unaudited pro forma condensed combined and consolidated financial information (the “Summary Pro Forma Information”) gives effect to the Business Combination. The Business Combination will be accounted for as a reverse recapitalization, in accordance with GAAP. Under this method of accounting, CLAQ will be treated as the “acquired” company for financial reporting purposes. Accordingly, the Business Combination will be reflected as the equivalent of Nauticus issuing shares for the net assets of CLAQ, followed by a recapitalization whereby no goodwill or other intangible assets are recorded. Operations prior to the Business Combination will be those of Nauticus. There will be no accounting effect or change in the carrying amount of the assets and liabilities as a result of the Business Combination. The summary unaudited pro forma condensed combined and consolidated balance sheet as of March 31, 2022 gives effect to the Business Combination as if it had occurred on March 31, 2022. The summary unaudited pro forma condensed combined and consolidated statement of operations for the three months ended March 31, 2022 and the year ended December 31, 2021 gives effect to the Business Combination as if they had occurred on January 1, 2021.

The Summary Pro Forma Information has been derived from, and should be read in conjunction with, the more detailed unaudited pro forma condensed combined and consolidated financial information included in the section titled “*Unaudited Pro Forma Condensed Combined and Consolidated Financial Information*” in this proxy statement/prospectus and the accompanying notes thereto. The unaudited pro forma condensed combined and consolidated financial information is based upon, and should be read in conjunction with, the historical financial statements and related notes of CLAQ and Nauticus for the applicable periods included elsewhere in this proxy statement/prospectus. The Summary Pro Forma Information has been presented for informational purposes only and is not necessarily indicative of what CLAQ’s financial position or results of operations actually would have been had the Business Combination been completed as of the dates indicated. In addition, the Summary Pro Forma Information does not purport to project the future financial position or operating results of CLAQ following the reverse recapitalization.

The unaudited pro forma condensed combined and consolidated financial information has been prepared using the assumptions below with respect to the potential redemption into cash of shares of CLAQ ordinary shares:

- **Assuming No Redemptions:** This scenario assumes that no public stockholders of CLAQ exercise redemption rights with respect to their public shares for a pro rata share of the funds in the Trust Account.
- **Assuming Maximum Redemptions:** This scenario assumes that 17,250,000 CLAQ Common Stock subject to redemption are redeemed for an aggregate payment of approximately \$174.2 million (based on an estimated per share redemption price of approximately \$10.10 that was calculated using the \$174.2 million of cash in the Trust Account divided by 17,250,000 CLAQ shares of Common Stock subject to redemption assuming the pro forma maximum redemption scenario pursuant to the Merger Agreement). Under the terms of the Merger Agreement, the aggregate cash proceeds received from the Trust Account, together with the proceeds from the Subscription Agreements and after the payment of transaction expenses, must equal no less than \$50.0 million.

	Pro Forma Combined	
	Assuming No Redemptions	Assuming Maximum Redemptions
Summary Unaudited Pro Forma Condensed Combined and Consolidated Statement of Operations Data For the Three Months Ended March 31, 2022		
Net loss	\$ (2,054,245)	\$ (2,054,245)
Basic and diluted net loss per share	\$ (0.04)	\$ (0.05)
Weighted average shares outstanding	55,986,279	38,736,279
Summary Unaudited Pro Forma Condensed Combined and Consolidated Statement of Operations Data For the Year Ended December 31, 2021		
Net loss	\$ (28,054,641)	\$ (28,054,641)
Basic and diluted net loss per share	\$ (0.50)	\$ (0.72)

	Pro Forma Combined	
	Assuming No Redemptions	Assuming Maximum Redemptions
Weighted average shares outstanding	55,986,279	38,736,279
Summary Unaudited Pro Forma Condensed Combined and Consolidated Balance Sheet Data		
As of March 31, 2022		
Total assets	\$ 231,427,466	\$ 57,179,493
Total liabilities	\$ 29,911,173	\$ 29,911,173
Total stockholders' equity	\$ 201,516,293	\$ 27,268,320

Interests of Certain Persons in the Business Combination

When you consider the recommendation of the Board in favor of adoption of the Business Combination Proposal and other Proposals, you should keep in mind that CLAQ's directors and officers and their affiliates have interests in the Business Combination that are different from, or in addition to, your interests as a shareholder, including:

- CLAQ's Co-sponsors have a fiduciary obligation to each of their respective members and Eli Spiro, (CLAQ's Chief Executive Officer and Director) and Jonas Grossman (a CLAQ Director) are the controlling members of our Co-sponsors. Because each of Mr. Spiro and Mr. Grossman have a fiduciary obligation to both CLAQ and the Co-sponsors, they had a conflict of interest when voting on the Business Combination.
- If an initial business combination, such as the Business Combination, is not completed, CLAQ will be required to dissolve and liquidate. In such event, the 4,312,500 founder shares currently held by the Initial Stockholders, which were acquired prior to the IPO will be worthless because such holders have agreed to waive their rights to any liquidation distributions. The founder shares were purchased for an aggregate purchase price of \$25,000, and had an aggregate market value of approximately \$43.3 million based on the closing price of \$10.03 per share of CLAQ common stock on the Nasdaq Stock Market as of May 20, 2022.
- If an initial business combination, such as the Business Combination, is not completed, an aggregate of 7,175,000 Private Warrants purchased by CLAQ's Co-sponsors for a total purchase price of \$7,175,000, will be worthless. The Private Warrants had an aggregate market value of approximately \$3.0 million based on the closing price of \$0.42 per Public Warrant on the Nasdaq Stock Market as of May 20, 2022.
- Because of these interests, CLAQ's Initial Stockholders could benefit from the completion of a business combination that is not favorable to its public shareholders and may be incentivized to complete an acquisition of a less favorable target company or on terms less favorable to public shareholders rather than liquidate. For example, if the share price of the CLAQ common stock declined to \$5.00 per share after the close of the business combination, CLAQ's public shareholder that purchased shares in the initial public offering, would have a loss of \$5.00 per share, while CLAQ's Sponsor would have a gain of \$4.99 per share because it acquired the founder shares for a nominal amount. In other words, CLAQ's Initial Stockholders can earn a positive rate of return on their investment even if public shareholders experience a negative rate of return in the post-combination company.
- One of CLAQ's Co-sponsors is CleanTech Sponsor, and the managing member of CleanTech Sponsor is Eli Spiro, CLAQ's Chief Executive Officer and Director. If an initial business combination, such as the Business Combination, is not completed, CleanTech Sponsor will lose an aggregate of approximately \$28.3 million, comprised of the following:
 - approximately \$26.0 million (based on the closing price of \$10.03 per share of CLAQ common stock on the Nasdaq Stock Market as of May 20, 2022) of the 2,595,000 founder shares CleanTech Sponsor holds;
 - approximately \$2.0 million (based on the closing price of \$0.42 per Public Warrant on the Nasdaq Stock Market as of May 20, 2022) of the 4,783,333 Private Warrants CleanTech Sponsor holds; and

- repayment of an interest-free loan of \$267,000 by CleanTech Sponsor since the loan will become payable only after Closing of the Business Combination, or the date on which CLAQ determines that it is unable to effect a business combination.
- CLAQ's other Co-sponsor, CleanTech Investments, is an affiliate of Chardan, and CLAQ's director, Mr. Jonas Grossman, is the Managing Partner and President of Chardan. If an initial business combination, such as the Business Combination, is not completed, Chardan will lose an aggregate of approximately \$23.8 million, comprised of the following:
 - approximately \$14.4 million (based on the closing price of \$10.03 per share of CLAQ common stock on the Nasdaq Stock Market as of May 20, 2022) of the 1,437,500 founder shares CleanTech Investment holds;
 - approximately \$1.0 million (based on the closing price of \$0.42 per Public Warrant on the Nasdaq Stock Market as of May 20, 2022) of the 2,391,667 Private Warrants CleanTech Investment holds;
 - a marketing fee of \$6,037,500 for certain services pursuant to a Business Combination Marketing Agreement;
 - a placement fee of \$2,118,000 (i.e., 6.0% of the PIPE Investment that is not sold to an affiliate of Chardan) for certain services pursuant to the Financial Advisory Agreement (pursuant to the Financial Advisory Agreement, Chardan also has a right of first refusal to act as a book-running manager with minimum economics of 15% for the first two public or private equity offerings by CLAQ or any successor or subsidiary of CLAQ);
 - repayment of an interest-free loan of \$133,000 by CleanTech Investments since the loan will become payable only after Closing of the Business Combination, or the date on which CLAQ determines that it is unable to effect a business combination; and
 - the \$10,000 monthly administrative fee under the Administrative Support Agreement pursuant to which CLAQ may delay payment of the same until the consummation of a business combination. As of March 2022, there is an accrued and unpaid balance of \$80,000 owed to Chardan under the Administrative Support Agreement.
- If an initial business combination, such as the Business Combination, is not completed, the Initial Stockholders will lose a combined aggregate amount of approximately \$46.7 million (including the Co-sponsors' loans and securities held based on the closing price of \$10.03 per share of CLAQ common stock and \$0.42 per Public Warrant on May 20, 2022), and the Initial Stockholders together with their affiliates (including Chardan) will lose a combined aggregate amount of approximately \$54.9 million (including Chardan's fees contingent upon the Closing of the Business Combination.)
- If the proposed Business Combination is not completed, CLAQ's Initial Stockholders will not have the potential ownership interest of approximately 6.8% (assuming no redemption) or 8.6% (assuming maximum redemption) in the combined company, assuming exercise and conversion of all securities.
- As of the date of this proxy statement/prospectus, ATW is the only purchaser for the Debentures and associated Warrants in the Debt Financing. ATW is managed by ATW Partners Opportunities Management, LLC, which is an affiliate of Chardan, and our director, Mr. Jonas Grossman, is the Managing Partner and President of Chardan.
- The exercise of CLAQ's directors' and officers' discretion in agreeing to changes or waivers in the terms of the transaction may result in a conflict of interest when determining whether such changes or waivers are appropriate and in our stockholders' best interest.
- If the Business Combination is completed, Nauticus will designate all members of the Combined Company's Board of Directors, except for the Transocean Designee).

See "Proposal 1 — The Business Combination Proposal — Interests of Certain Persons in the Business Combination" for additional information.

Anticipated Accounting Treatment

For a discussion summarizing the anticipated accounting treatment of the Business Combination, please see “Anticipated Accounting Treatment.”

Recommendations of the Board and Reasons for the Business Combination

After careful consideration of the terms and conditions of the Merger Agreement, the Board has determined that Business Combination and the transactions contemplated thereby are fair to, and in the best interests of, CLAQ and its stockholders. In reaching its decision with respect to the Business Combination and the transactions contemplated thereby, the Board reviewed various industry and financial data and the evaluation of materials provided by Nauticus. On January 28, 2022, in order to provide added transparency to the transactions contemplated by the Merger Agreement and greater certainty to close the Business Transaction in the current turbulent market, CLAQ retained Duff & Phelps to serve as an independent financial advisor to the Board of CLAQ, specifically to provide to the Board a fairness opinion in connection with the Business Combination. On March 24, 2022, the Board obtained a fairness opinion from Duff & Phelps. The Board recommends that CLAQ stockholders vote:

- FOR the Business Combination Proposal;
- FOR the Charter Approval Proposal;
- FOR the Bylaws Proposal;
- FOR the Governance Proposals;
- FOR the Directors Proposal;
- FOR the Stock Plan Proposal;
- FOR the Nasdaq Merger Proposal;
- FOR the Nasdaq PIPE Proposal; and
- FOR the Adjournment Proposal.

Summary Risk Factors

In evaluating the Business Combination and the Proposals to be considered and voted on at the Meeting, you should carefully review and consider the risk factors set forth under the section entitled “*Risk Factors*” beginning on page 45 of this proxy statement/prospectus. Some of these risks related to are summarized below. References in the summary below to “Nauticus” or “Nauticus Robotics” generally refer to Nauticus in the present tense or the Combined Company from and after the Business Combination.

The following summarizes certain principal factors that make an investment in the Combined Company speculative or risky, all of which are more fully described in the “*Risk Factors*” section below. This summary should be read in conjunction with the “*Risk Factors*” section and should not be relied upon as an exhaustive summary of the material risks facing CLAQ’s, Nauticus’ and/or the Combined Company’s business.

Risks Related to Nauticus’ Business and Industry

- Nauticus is an early-stage company with a history of losses, and it expects to incur significant expenses for the foreseeable future.
- Almost all of Nauticus’ revenues in 2020, 2021, and the first quarter of 2022 were derived from three customers. A substantial portion of Nauticus’ current revenue is generated by sales to government entities, which are subject to a number of uncertainties, challenges, and risks.
- If Nauticus fails to effectively manage its growth, Nauticus may not be able to design, develop, manufacture, market, and launch new generations of its robotic systems successfully.

- Nauticus’ operating and financial projections rely on management assumptions and analyses. If these assumptions or analyses prove to be incorrect, Nauticus’ actual operating results may be materially different from its forecasted results.
- Nauticus’ business plans require a significant amount of capital. Nauticus’ future capital needs may require Nauticus to sell additional equity or debt securities that may dilute its stockholders or introduce covenants that may restrict its operations or its ability to pay dividends.
- Nauticus will incur significant increased expenses and administrative burdens as a public company, which could have a material adverse effect on its business, prospects, financial condition and operating results.
- Nauticus operates in a competitive industry that is subject to rapid technological change, and Nauticus expects competition to increase.
- Nauticus’ financial results may vary significantly from period to period due to fluctuations in its operating costs, product demand and other factors.
- Nauticus has yet to achieve positive operating cash flow and, given its projected funding needs, its ability to generate positive cash flow is uncertain.

Risks Related to CLAQ’s Business

- CLAQ’s independent registered public accounting firm’s report contains an explanatory paragraph that expresses substantial doubt about CLAQ’s ability to continue as a “going concern.”
- Failure to comply with applicable anti-corruption legislation and other governmental laws and regulations could result in fines, criminal penalties and materially adversely affect its business, financial condition and results of operations.
- The continuation or worsening of the COVID-19 pandemic, or other similar public health developments, could have an adverse effect on business, results of operations, and financial condition.
- CLAQ will be forced to liquidate the Trust Account if it cannot consummate a business combination by July 19, 2022, the date that is 12 months from the closing of the IPO (or January 19, 2023, the date that is 18 months from the closing of the IPO, if the Combination Period is extended by the full amount of time allowed under CLAQ’s Current Charter). In the event of a liquidation, CLAQ’s public stockholders will receive \$10.10 per share and the CLAQ Warrants and Rights will expire worthless.

Risks Related to the Business Combination

- You must tender your Public Common Stock in order to validly seek redemption at the Meeting of stockholders.
- If third parties bring claims against CLAQ, the proceeds held in trust could be reduced and the per share liquidation price received by CLAQ’s stockholders may be less than \$10.10.
- Any distributions received by CLAQ stockholders could be viewed as an unlawful payment if it was proved that immediately following the date on which the distribution was made, CLAQ was unable to pay its debts as they fell due in the ordinary course of business.
- If CLAQ’s due diligence investigation of Nauticus was inadequate, then stockholders of CLAQ following the Business Combination could lose some or all of their investment.
- We may redeem your unexpired warrants prior to their exercise at a time that is disadvantageous to you, thereby making your Public Warrants worthless.

Risks Related to the Combined Company's Common Stock

- Because the Combined Company will become a public reporting company by means other than a traditional underwritten initial public offering, the Combined Company's stockholders may face additional risks and uncertainties.
- The market price of the Combined Company's Common stock is likely to be highly volatile, and you may lose some or all of your investment.
- Volatility in the Combined Company's share price could subject the Combined Company to securities class action litigation.

Risks Related to the Combined Company Operating as a Public Company

- Our management team has limited skills and experience related to managing a public company
- We will incur increased costs as a result of operating as a public company, and our management will be required to devote substantial time to new compliance initiatives and corporate governance practices.
- Our stock price has fluctuated historically and may continue to fluctuate.

SELECTED HISTORICAL FINANCIAL DATA OF CLAQ

CLAQ is providing the following summary historical financial information to assist you in your analysis of the financial aspects of the Business Combination.

CLAQ's consolidated statements of operations data for the three months ended March 31, 2022 and the audited consolidated financial statements of CLAQ as of December 31, 2021 and consolidated balance sheet data as of March 31, 2022 are derived from CLAQ's consolidated financial statements included elsewhere in this proxy statement/prospectus.

This information is only a summary and should be read in conjunction with CLAQ's consolidated financial statements and related notes and the sections entitled "*Management's Discussion and Analysis of Financial Condition and Results of Operations of CLAQ*" included elsewhere in this proxy statement/prospectus. The historical results included below and elsewhere in this proxy statement are not indicative of the future performance of CLAQ.

	March 31, 2022
Balance Sheet Data:	
Cash	\$ 296,381
Investments held in Trust Account	\$ 174,247,973
Total assets	\$ 174,589,345
Total liabilities	\$ 6,121,361
Common stock subject to possible redemption	\$ 174,225,000
Total stockholders' deficit	\$ (5,757,016)

	For the Three Months Ended March 31, 2022	For the Year Ended December 31, 2021
Statement of Operations Data:		
Loss from operations	\$ (479,375)	\$ (1,298,583)
Transaction costs	\$ —	\$ (155,037)
Change in fair value of warrant liabilities	\$ 2,413,500	\$ 1,077,750
Change in fair value of over-allotment option liability	\$ —	\$ (225,000)
Net gain on investments held in Trust Account	\$ 17,545	\$ 5,428
Net income (loss)	\$ 1,951,670	\$ (595,442)
Basic weighted average shares outstanding	21,562,500	11,781,678
Basic net income (loss) per share of common stock	\$ 0.09	\$ (0.05)
Diluted weighted average shares outstanding	21,562,500	11,781,678
Diluted net income (loss) per share of common stock	\$ 0.09	\$ (0.05)
Statement of Cash Flows Data:		
Net cash used in operating activities	\$ (489,524)	\$ (1,039,814)
Net cash used in investing activities	\$ —	\$ (174,225,000)
Net cash provided by financing activities	\$ 267,000	\$ 175,758,719

SELECTED HISTORICAL FINANCIAL DATA OF NAUTICUS

The following tables contain selected historical financial data of Nauticus for the periods and as of the dates indicated. Such data as of and for the years ended December 31, 2021 and 2020 are derived from the audited financial statements of Nauticus, which are included elsewhere in this proxy statement/prospectus. Such data as of and for the three months ended March 31, 2022 and 2021 are derived from the unaudited financial statements of Nauticus included elsewhere in this proxy statement/prospectus.

The following selected historical financial data should be read together with “*Management’s Discussion and Analysis of Financial Condition and Results of Operations of Nauticus*”, Nauticus’ audited financial statements and related notes thereto, and unaudited interim financial statements included elsewhere in this proxy statement/prospectus. The selected historical financial data in this section is not intended to replace our audited financial statements, unaudited consolidated financial statements, and related notes and are qualified in their entirety thereby. The historical results included below and elsewhere in this proxy statement/prospectus are not indicative of the future performance of Nauticus.

	For the Three Months ended March 31, 2022	For the Three Months ended March 31, 2021	Year Ended December 31,	
			2021	2020
Statement of Operations Data:				
Revenue	\$ 2,235,965	\$ 302,743	\$ 8,591,540	\$ 3,994,440
Costs and expenses				
Cost of revenue	\$ 1,899,161	\$ 698,888	6,850,248	4,059,991
Depreciation	\$ 111,319	\$ 87,716	365,097	400,432
Research and development	\$ 1,267,412	\$ 1,202,718	3,533,713	4,951,619
General and administrative	\$ 1,646,041	\$ 659,706	4,362,400	3,319,455
Total costs and expenses	\$ 4,923,933	\$ 2,649,028	15,111,458	12,731,497
Operating loss	\$ (2,687,968)	\$ (2,346,285)	(6,519,918)	(8,737,057)
Other expense (income)				
Other income	\$ 14,060	\$ (888,153)	(1,601,568)	(1,609,962)
Loss on extinguishment of debt	—	—	9,484,113	—
Interest expense (income), net	\$ 801,974	\$ 61,550	725,166	66,943
Net loss	\$ (3,504,002)	\$ (1,519,682)	\$ (15,127,629)	\$ (7,194,038)
Basic and diluted weighted average shares outstanding	\$ 680,600	\$ 678,400	678,406	678,400
Basic and diluted net loss per share of common stock	\$ (5.15)	\$ (2.24)	\$ (22.30)	\$ (10.60)
Statement of Cash Flows Data:				
Net cash used in operating activities	\$ (4,200,250)	\$ (2,314,957)	\$ (5,923,190)	\$ (4,499,775)
Net cash (used in) provided by investing activities	\$ (1,675,238)	—	\$ (922,487)	\$ 996,482
Net cash provided by financing activities	—	\$ 1,459,661	\$ 24,500,364	\$ 2,539,909

	As of March 31, 2022	As of December 31,	
		2021	2020
Balance Sheet Data:			
Cash and cash equivalents	\$ 15,077,379	\$ 20,952,867	\$ 3,298,180
Total assets	\$ 22,033,584	\$ 25,167,372	\$ 5,332,612
Total liabilities	\$ 31,948,886	\$ 31,778,829	\$ 6,761,333
Total stockholders’ deficit	\$ (9,915,302)	\$ (6,611,457)	\$ (1,428,721)

TRADING MARKET AND DIVIDENDS

CLAQ

Units, Common Stock, Rights and Warrants

The Units, Common Stock, Rights and Warrants are each quoted on the Nasdaq Stock Market, under the symbols “CLAQU,” “CLAQ,” “CLAQR,” and “CLAQW,” respectively. Each of CLAQ’s Units consists of one share of common stock, one Right and one-half of a Warrant. Each Right entitles the holder thereof to receive one-twentieth (1/20) of one share of common stock. Each whole Warrant entitles the holder thereof to purchase one share of common stock at a price of \$11.50 per share. The Units, common stock, Rights and Warrants commenced trading on the Nasdaq Stock Market separately on or about August 4, 2021.

CLAQ’s Dividend Policy

CLAQ has not paid any cash dividends on its shares of common stock to date and does not intend to pay cash dividends prior to the completion of a business combination. The payment of cash dividends in the future will be dependent upon CLAQ’s revenues and earnings, if any, capital requirements and general financial condition subsequent to completion of a business combination. Further, if we incur any indebtedness, CLAQ’s ability to declare dividends may be limited by restrictive covenants CLAQ may agree to in connection therewith. The payment of any dividends subsequent to a business combination will be within the discretion of the Combined Company’s Board of Directors. It is the present intention of the Board to retain all earnings, if any, for use in its business operations and, accordingly, the Board does not anticipate declaring any dividends in the foreseeable future.

Nauticus

Holders of Nauticus

As of the Record Date, there were holders of record of Nauticus stock.

Dividend Policy of Nauticus

Nauticus has not paid any cash dividends on its stock to date and does not intend to pay cash dividends prior to the completion of the Business Combination.

Combined Company

Dividend Policy

Following completion of the Business Combination, the Combined Company’s Board of Directors will consider whether or not to institute a dividend policy. It is presently intended that the Combined Company retain its earnings for use in business operations and accordingly, we do not anticipate Combined Company’s Board of Directors declaring any dividends in the foreseeable future.

RISK FACTORS

You should consider carefully the following risk factors, as well as the other information set forth in this proxy statement/prospectus, before making a decision on the Business Combination. Risks related to Nauticus, including risks related to Nauticus' business, financial position and capital requirements, development, regulatory approval and commercialization, dependence on third parties, intellectual property and taxation, will continue to be applicable to the Combined Company after the closing of the Business Combination.

Risks Related to Nauticus' Business and Industry

Nauticus is an early-stage company with a history of losses, and it expects to incur significant expenses for the foreseeable future.

Nauticus incurred a net loss of \$3.5 million for the three months ended March 31, 2022 and \$15.1 million and \$7.2 million for the years ended December 31, 2021 and 2020, respectively. Nauticus believes that it will continue to incur operating and net losses each quarter until at least the fourth quarter of 2022. Even though Nauticus has commercial traction for platform sales, it may not attract customers for its RaaS offering, Nauticus' potential profitability is dependent upon the successful adoption on a larger scale of its robotics systems, which may not occur. There can be no assurance that Nauticus will be financially successful.

Nauticus expects the rate at which it will incur losses will be significantly higher in future periods as Nauticus:

- continues to design, develop, manufacture and commercialize its ocean robotic systems;
- continues to utilize and develop potential new relationships with third-party partners for supply, design to manufacturing and manufacturing;
- expands its production capabilities, including costs associated with potential outsourcing the manufacturing of its ocean robotic systems;
- builds up inventories of parts and components for its ocean robotic systems;
- matures its maintenance and servicing capacity, capabilities, and replacement parts inventory;
- manufactures an inventory of its ocean robotic systems;
- increases its sales and marketing activities and enhances its sales and distribution infrastructure;
- further develop its remote monitoring, updating, and other cloud-based services;
- refines its safety measures for the ocean robotic systems;
- expands its technology infrastructure and cybersecurity measures, policies, and controls; and
- increases its general and administrative functions to support its growing operations and to operate as a public company.

Because Nauticus will incur costs and expenses from these efforts before it receives any incremental revenues with respect thereto, Nauticus' losses in future periods will be significant. In addition, Nauticus may find that these efforts are more expensive than it currently anticipates or that these efforts may not result in revenues, which would further increase Nauticus' losses.

Nauticus has identified a material weakness in its internal control over financial reporting. This material weakness could continue to adversely affect Nauticus' ability to report its results of operations and financial condition accurately and in a timely manner.

Nauticus management is responsible for establishing and maintaining adequate internal control over financial reporting designed to provide reasonable assurance regarding the reliability of financial reporting and the preparation of consolidated financial statements for external purposes in accordance with GAAP. Nauticus' management is likewise required, on a quarterly basis, to evaluate the effectiveness of its internal controls. Nauticus has identified a material weakness in its internal control over financial reporting, such that there is a reasonable possibility that a material misstatement of Nauticus' annual or interim financial statements will not be prevented or detected on a timely basis.

Nauticus identified certain accounting errors related to the financial statements. As a result, Nauticus management concluded that a material weakness existed in its internal control over financial reporting related to the identification and review of technical issues associated with certain unique, unusual and nonstandard transactions within Nauticus' equity process. As a result of this material weakness, Nauticus' management concluded that its internal control over financial reporting was not effective as of December 31, 2021.

To address this material weakness, Nauticus has engaged a technical accounting and financial reporting consulting firm to assist the company with (i) its financial accounting close, (ii) the application of technical accounting literature, (iii) the preparation of its financial statements, and (iv) the independent audit of its financial statements. Nauticus' plan is to employ additional financial and accounting personnel in key finance and accounting positions. The company has identified some new personnel and expects to secure their full-time employment by the end of third quarter 2022. Nauticus expects to incur on-going significant costs to meet the corporate governance provisions of the Sarbanes-Oxley Act of 2002, related regulations of the SEC, and the requirements of NASDAQ, with which Nauticus is not required to comply presently as a private company. Complying with these statutes, regulations, and requirements will occupy a significant amount of the Nauticus board of director's and management's time and will significantly increase its costs and expenses.

While Nauticus believes these actions will address the reported material weakness, Nauticus can give no assurances that these actions will remediate the deficiency in internal control or that additional material weaknesses or significant deficiencies in its internal control over financial reporting will not be identified in the future. Nauticus' failure to implement and maintain effective internal control over financial reporting could result in errors in its financial statements that could result in a restatement of its financial statements and cause it to fail to meet its reporting obligations.

In addition to the steps already taken, Nauticus plans to continue to devote, significant effort and resources to the remediation and improvement of its internal control over financial reporting. While Nauticus has processes to identify and appropriately apply applicable accounting requirements, Nauticus plans to enhance these processes to better evaluate its research and understanding of the nuances of the complex accounting standards that apply to its consolidated financial statements. These include providing enhanced access to accounting literature, research materials and documents, increased communication among its personnel, hiring additional technical accounting resources, and third-party professionals with whom Nauticus consults regarding complex accounting applications. The elements of its continued remediation plan can only be accomplished over time, and Nauticus can offer no assurances that these initiatives will ultimately have all or some of the intended effects.

Any failure to maintain such internal control could adversely impact Nauticus' ability to report its financial position and results of operations on a timely and accurate basis. If Nauticus' financial statements are not accurate, investors may not have a complete understanding of its operations. Likewise, if after the Business Combination, Nauticus' financial statements are not filed on a timely basis, Nauticus could be subject to sanctions or investigations by the stock exchange on which its common stock is listed, the SEC or other regulatory authorities. In either case, that could result in a material adverse effect on Nauticus' business. Ineffective internal controls could also cause investors to lose confidence in Nauticus' reported financial information which could have a negative effect on the trading of Nauticus stock.

Nauticus can give no assurances that going forwards the measures it plans to take in the future will remediate any additional material weaknesses or restatements of financial results will not arise in the future due to failure to implement and maintain adequate control over financial reporting or circumvention of these controls. In addition, even if Nauticus is successful in strengthening its controls and procedures, in the future those controls and procedures may not be adequate to prevent or identify irregularities or errors or to facilitate the fair preparation and presentation of our consolidated financial statements.

Almost all of Nauticus' revenues in 2020, 2021, and the first quarter of 2022 were derived from three customers. A substantial portion of Nauticus' current revenue is generated by sales to government entities, which are subject to a number of uncertainties, challenges, and risks.

Nauticus currently has a limited number of customers. For the three months ended March 31, 2022, sales to one customer accounted for 95% of total revenue, sales to another customer accounted for 4% of total revenue, and sales to another customer accounted for 1% of total revenue. For the year ended December 31, 2021, sales to one customer accounted for 89% of total revenue and the total balance due from this customer as of December 31, 2021 made up 82% of accounts receivable. For the year ended December 31, 2020, sales to one customer accounted for 61% of total revenue, sales to another customer accounted for 20% of total revenue, and sales to another customer accounted

for 17% of total revenue. The total balances due from these customers as of December 31, 2020 made up 100% of accounts receivable. Sales to government entities are subject to a number of risks. Selling to government entities can be highly competitive, expensive, and time-consuming, often requiring significant upfront time and expense without any assurance that these efforts will generate a sale. In the event that Nauticus is successful in being awarded further government contracts, such awards may be subject to appeals, disputes, or litigation, including, but not limited to, bid protests by unsuccessful bidders. Government demand and payment for Nauticus' solutions may be impacted by public sector budgetary cycles and funding authorizations, with funding reductions or delays adversely affecting public sector demand for Nauticus' solutions. Government entities may have statutory, contractual, or other legal rights to terminate Nauticus' contracts for convenience or default. For purchases by the U.S. federal government, the government may require certain products to be manufactured in the United States and other high cost manufacturing locations, and Nauticus or any third-party manufacturers may not manufacture all products in locations that meet government requirements, and as a result, Nauticus' business and results of operations may suffer.

As a government contractor or subcontractor, Nauticus must comply with laws, regulations, and contractual provisions relating to the formation, administration, and performance of government contracts and inclusion on government contract vehicles, which affect how Nauticus and its partners do business with government agencies. As a result of actual or perceived noncompliance with government contracting laws, regulations, or contractual provisions, Nauticus may be subject to non-ordinary course audits and internal investigations which may prove costly to its business financially, divert management time, or limit Nauticus' ability to continue selling its products to its government customers. These laws and regulations may impose other added costs on Nauticus' business, and failure to comply with these or other applicable regulations and requirements, including non-compliance in the past, could lead to claims for damages, downward contract price adjustments or refund obligations, civil or criminal penalties, and termination of contracts and suspension or debarment from government contracting for a period of time with government agencies. Any such damages, penalties, disruption, or limitation in Nauticus' ability to do business with a government would adversely impact, and could have a material adverse effect on, Nauticus' business, prospects, financial condition and operating results.

If Nauticus fails to effectively manage its growth, Nauticus may not be able to design, develop, manufacture, market, and launch new generations of its robotic systems successfully.

Nauticus intends to invest significantly in order to expand its business. Any failure to manage Nauticus' growth effectively could materially and adversely affect Nauticus' business, prospects, financial condition, and operating results. Nauticus intends to expand its operations significantly. Nauticus expects its expansion to include:

- expanding the management, engineering, and product teams;
- identifying and recruiting individuals with the appropriate relevant experience;
- hiring and training new personnel;
- launching commercialization of new products and services;
- forecasting production and revenue and implementing enterprise resource planning (ERP) systems;
- entering into relationships with one or more third-party design for manufacturing partners and third-party manufacturers and/or expanding its internal manufacturing capabilities;
- controlling expenses and investments in anticipation of expanded operations;
- carrying out acquisitions and entering into collaborations, in-licensing arrangements, joint ventures, strategic alliances or partnerships;
- expanding and enhancing internal information technology, safety, and security systems;
- establishing or expanding sales, customer service and maintenance and servicing facilities and organization;
- conducting demonstrations of ocean robotic systems;
- entering into agreements with suppliers and service providers; and
- implementing and enhancing administrative infrastructure, systems, and processes.

[Table of Contents](#)

Nauticus intends to continue to hire a significant number of additional personnel, including engineers, design and production personnel and service technicians for its ocean robotic systems and services. Because of the innovative nature of Nauticus' technology, individuals with the necessary experience may not be available to hire, and as a result, Nauticus will need to expend significant time and expense to recruit and retain experienced employees and appropriately train any newly hired employees. Competition for individuals with experience designing, producing, and servicing dexterous ocean robots and their software is intense, and Nauticus may not be able to attract, integrate, train, motivate or retain additional highly qualified personnel. The failure to attract, integrate, train, motivate and retain these additional employees could seriously harm Nauticus' business, prospects, financial condition and operating results.

Nauticus' operating and financial projections rely on management assumptions and analyses. If these assumptions or analyses prove to be incorrect, Nauticus' actual operating results may be materially different from its forecasted results.

Nauticus is an ocean robotics and services company, with limited experience commercializing its products and services. The projected financial and operating information appearing elsewhere in this proxy statement/prospectus reflect estimates of future performance and is based on multiple financial, technical, and operational assumptions, including hiring of additional skilled personnel in a timely way to support continued development and commercialization of the core products, timing of commercial launch of the ocean robotic systems, the level of demand for Nauticus' ocean robotic systems, the performance of Nauticus' ocean robotic systems, the utilization of the ocean robot fleet, commercial interest in the RaaS subscription model, the useable life of the ocean robotic systems, cost of manufacturing, cost of components and availability of adequate supply, the nature and length of the sales cycle, maintenance and servicing costs and the costs of refurbishing the ocean robotic systems. However, given Nauticus' limited commercial experience, it is likely that many of these assumptions will prove incorrect. The projections are forward-looking statements that are inherently subject to significant uncertainties and contingencies, many of which are beyond Nauticus' control. See "Risk Factors," "Nauticus' Management's Discussion and Analysis of Financial Condition and Results of Operations" and "Cautionary Note Regarding Forward-Looking Statements." Whether actual operating and financial results and business developments will be consistent with Nauticus' expectations and assumptions as reflected in its forecast depends on a number of other factors, many of which are outside Nauticus' control, including, but not limited to:

- whether Nauticus can obtain sufficient capital to sustain and grow its business;
- Nauticus' ability to manage its growth;
- the contractual terms of one or more agreements with third-party manufacturers;
- whether Nauticus can manage relationships with key suppliers and partners;
- the timing and costs of the required marketing and promotional efforts;
- the timing and cost of each sale or RaaS subscription;
- whether customers and their employees will adopt the ocean robotic systems offered by Nauticus;
- the timing required and success of customer testing of Nauticus' technology;
- competition, including from established and future competitors;
- Nauticus' ability to retain existing key management, to attract additional leaders, to integrate recent hires and to attract, retain and motivate qualified personnel, including engineers, design and production personnel, and service technicians;
- the overall strength and stability of domestic and international economies;
- demand for currently available and future ocean robots;
- regulatory, legislative, and political changes; and
- customer requirements and preferences.

[Table of Contents](#)

Unfavorable changes in any of these or other factors, most of which are beyond Nauticus' control, could cause Nauticus to fail to meet its operating and financial projections and could materially and adversely affect its business, prospects, financial condition and operating results. For more information regarding Nauticus' projections, please see the section entitled "*Proposal 1 — The Business Combination Proposal — Certain Nauticus' Projected Financial Information.*"

We rely on third party manufacturers/suppliers and expect to continue to do so for the foreseeable future. This reliance on third parties increases the risk that we will not have sufficient quantities of our products or such quantities at an acceptable cost, which could delay, prevent or impair our development or commercialization efforts.

We rely, and expect to continue to rely, on third party manufacturers/suppliers. This reliance on third party manufacturers/suppliers increases the risk that we will not have sufficient quantities of our products or such quantities at an acceptable cost, which could delay, prevent or impair our development or commercialization efforts. Additionally, we may be unable to establish or continue any agreements with third-party manufacturers/suppliers or to do so on acceptable terms. Even if we are able to establish agreements with third-party manufacturers/suppliers, reliance on third-party manufacturers/suppliers entails additional risks, including:

- failure of third-party manufacturers/suppliers to comply with regulatory requirements and maintain quality assurance;
- breach of the manufacturing/supply agreement by the third party;
- failure to manufacture/supply our product according to our specifications;
- failure to manufacture/supply our product according to our schedule or at all;
- misappropriation of our proprietary information, including our trade secrets and know-how; and
- termination or nonrenewal of the agreement by the third party at a time that is costly or inconvenient for us.

If our current or future third-party manufacturers/suppliers cannot perform as agreed, we may be required to replace such manufacturers/suppliers and we may be unable to replace them on a timely basis or at all. Our current and anticipated future dependence upon third party manufacturers/suppliers may adversely affect our future profit margins and our ability to commercialize any products that receive marketing approval on a timely and competitive basis.

The commercial RaaS launch of Nauticus' core product, Aquanaut, may be delayed beyond the end of 2022.

Nauticus expects to commercially launch its RaaS business model to the public at large by the end of 2022. A delay in the delivery and readiness of its core product, Aquanaut, due to the factors mentioned below would also delay the generation of revenue through the RaaS business model. Both Aquanaut and the subsequent RaaS revenue stream may be delayed if the risks mentioned herein are not mitigated. Among the significant current challenges that could delay the commercial launch are:

- The COVID-19 pandemic and general labor shortages of qualified applicants has affected and may continue to affect Nauticus' ability to recruit skilled employees to join its team, negatively affecting the timeline.
- Nauticus and its suppliers are currently experiencing increases in cost of and an interruption in the supply and shortage of materials. Due to the nature of Nauticus' products, each unit contains several major subsystem components. Difficulty securing any components and materials could result in delays in the production of these platforms, which delays could be compounded if components or units require redesign.
- Delays in the production of Aquanaut due to these challenges also affect negotiations with third party contract manufacturers, as such negotiations are more complicated if the units and/or components are undergoing improvements. If Nauticus is unable to enter into definitive agreements or is only able to do so on terms that are less commercially favorable to Nauticus, it may need to enhance its own manufacturing and production capabilities, which may impact Nauticus' operating expenditures and profitability.

Nauticus' financial projections, particularly its projected increases in revenue starting in 2023, were premised on a commercial launch of the RaaS business model by the 4th quarter, 2022. Delays in this launch will result in a commensurate delay in revenues and profitability.

Nauticus has limited experience commercializing its products at a large scale and may not be able to do so efficiently or effectively.

Although Nauticus has sold products to a limited number of individual customers in the past, it has limited experience commercializing ocean robotic systems at a large scale and may not be able to do so efficiently or effectively. A key element of Nauticus' long-term business strategy is the continued growth in sales, marketing, training, customer service and maintenance and servicing operations, including hiring personnel with the necessary experience. Managing and maintaining these operations is expensive and time consuming, and an inability to leverage such an organization effectively or at all could inhibit potential sales or subscriptions and the penetration and adoption of Nauticus' products into new markets. In addition, certain decisions Nauticus makes regarding staffing in these areas in its efforts to maintain an adequate spending level could have unintended negative effects on its revenues, such as by weakening the sales, marketing and maintenance and servicing infrastructures or lowering the quality of customer service.

Nauticus' business plans require a significant amount of capital. Nauticus' future capital needs may require Nauticus to sell additional equity or debt securities that may dilute its stockholders or introduce covenants that may restrict its operations or its ability to pay dividends.

Nauticus will require significant capital to operate its business and fund its capital expenditures for the next several years. While Nauticus expects that following the Business Combination, Nauticus will have sufficient capital to fund its currently planned operations for the foreseeable future, it is possible that Nauticus will need to raise additional capital to fund its business, including to finance ongoing research and development costs, manufacturing, any significant unplanned or accelerated expenses, and new strategic alliances or acquisitions. The fact that Nauticus has limited experience commercializing its ocean robotic systems on a large scale, coupled with the fact that Nauticus' products represent a new product category in the commercial and industrial ocean robotic market, means Nauticus has limited historical data on the demand for its robotic systems. In addition, Nauticus expects its capital expenditures to continue to be significant in the foreseeable future as it continues generational improvements for its commercial products, and that its level of capital expenditures will be significantly affected by customer demand for its ocean robotic systems. As a result, Nauticus' future capital requirements may be uncertain and actual capital requirements may be different from those it currently anticipates. Nauticus may need to seek equity or debt financing to finance a portion of its capital expenditures. Such financing might not be available to Nauticus in a timely manner or on terms that are acceptable, or at all.

Nauticus' ability to obtain the necessary financing to carry out its business plan is subject to a number of factors, including general market conditions and investor acceptance of Nauticus' business model. These factors may make the timing, amount, terms, and conditions of such financing unattractive or unavailable to Nauticus. If Nauticus is unable to raise sufficient funds, it will have to significantly reduce its spending, delay or cancel its planned activities or substantially change its corporate structure. Nauticus might not be able to obtain any funding, and it might not have sufficient resources to conduct its business as projected, both of which could mean that Nauticus would be forced to curtail or discontinue its operations.

In addition, Nauticus' future capital needs and other business reasons could require it to sell additional equity or debt securities or obtain a credit facility. The sale of additional equity or equity-linked securities could dilute its stockholders. The incurrence of indebtedness would result in increased debt service obligations and could result in operating and financing covenants that would restrict Nauticus' operations.

If Nauticus cannot raise additional funds when it needs or want them, its operations and prospects could be negatively affected.

To date, Nauticus' cash needs have been met with debt and equity funding from its principal stockholders. If the Business Combination is not consummated and Nauticus is not able to obtain sufficient funding, its business, prospects, financial condition and operating results will be harmed and Nauticus may be unable to continue as a going concern.

Nauticus' products and services are disruptive to the ocean services industries, and important assumptions about the market demand, pricing, adoption rates and sales cycle, for its current and future products and services may be inaccurate.

Nauticus' core offering, its tetherless surface and subsea robot pair, are a new service paradigm in the ocean services markets and which are currently dominated by conventional, tethered devices with large surface vessels. The market demand for and adoption of Nauticus' offering is unproven, and important assumptions about the characteristics of targeted markets, pricing, and sales cycles may be inaccurate. Although Nauticus has engaged in ongoing dialogue with potential customers, it has few binding commitments to purchase its products and services and no hard commitments to enter into RaaS subscriptions. Existing or new regulatory or safety standards, or resistance by customer employees and labor unions, all of which are outside of Nauticus' control, could cause delays or otherwise impair adoption of these new technologies, which will adversely affect Nauticus' growth, financial position, and prospects. Given the evolving nature of the markets in which Nauticus operates, it is difficult to predict customer demand or adoption rates for its products or the future growth of the markets Nauticus expects to target. If one or more of the targeted markets experience a shift in customer or prospective customer demand, Nauticus' products may not compete as effectively, if at all, and they may not be fully developed into commercial products. As a result, the financial projections in this proxy statement/prospectus necessarily reflect various estimates and assumptions that may not prove accurate and these projections could differ materially from actual results because of the risks included in this "Risk Factors" section, among others. If demand does not develop as expected or if Nauticus cannot accurately forecast pricing, adoption rates and sales cycle for its products, its business, results of operations and financial condition will be adversely affected.

With Nauticus' service offering still being commercialized at a large scale, Nauticus has limited current customers and no hard contracts for the RaaS offering, and there is no assurance that expected customer demand will result in binding orders or subscriptions.

Nauticus expects to launch its core RaaS offering by the end of 2022. This evaluation is based on the time to complete production of the initial RaaS fleet. With initial fleet still under production, Nauticus has no binding commitments for its RaaS offering. At present, Nauticus has contracts for delivery of pre-production units with U.S. government customers and it also has had and currently has revenue generating contracts with both commercial and U.S. Government customers. Pre-production means that the unit that has not gone through a subsequent design evolution for mass production (defined as tens of units per year). Although Nauticus has engaged in dialogue (i.e. MOUs) with potential customers about their interest in Nauticus' offering, there is no assurance that expected customer trials and discussions will result in binding commitments. There may be variability in the customer testing time that will be required to adopt its RaaS offering. As such, customer testing may be longer than anticipated by Nauticus, and Nauticus may not be able to provide such testing to the satisfaction of prospective customers, which could result in longer sales cycles and lower subscriptions revenue than anticipated. In addition, in order to build and maintain its business, Nauticus must maintain confidence among customers, suppliers, analysts, ratings agencies and other parties in its ocean robotic systems, long-term financial viability and business prospects. Maintaining such confidence may be particularly complicated by certain factors including those that are largely outside of Nauticus' control, such as its limited commercial experience, customer unfamiliarity with its products, any delays in scaling production, inability of delivery and service operations to meet demand, competition and uncertainty regarding the future of ocean robotics. If Nauticus does not receive a sufficient number of binding orders for its products or RaaS subscriptions, its business, prospects, financial condition and operating results could be materially and adversely affected.

The benefits of Nauticus' products to customers and projected return on investment have not been substantiated through long-term trials or use.

Nauticus' core products' benefits to customers and projected return on investment have not been substantiated through long-term trials or use. Nauticus currently has a limited frame of reference by which to evaluate the performance of its ocean robotic systems upon which its business prospects depend. There can be no assurance that such units will provide the expected benefit to customers. Nauticus' ocean robotic systems may not perform consistently with customers' expectations or consistently with other robotics products which may become available. Any failure of Nauticus' robotic systems and software to perform as expected could harm Nauticus' reputation and result in adverse publicity, lost revenue, delivery delays, product recalls, product liability claims and significant warranty and other expenses and could have a material adverse impact on Nauticus' business, prospects, financial condition and operating results. Additionally, problems and defects experienced by competitors or others in the ocean robotics market could, by association, have a negative impact on perception and customer demand for Nauticus' ocean robotic systems.

Nauticus may fail to attract or retain customers for RaaS business model at sufficient rates or at all.

Nauticus has limited experience commercializing its RaaS business model and may not be able to do so efficiently or effectively. Although Nauticus has engaged in ongoing dialogue with potential future customers, there are currently no binding commitments with commercial customers to enter into RaaS agreements with respect to its ocean services. To grow its customer base, Nauticus must achieve binding commitments from expected customers and add new customers, which Nauticus may not be able to do in sufficient numbers or at all. Even if Nauticus is able to attract customers, these customers may not maintain a high level of commitment to Nauticus' products and services. In addition, Nauticus will incur marketing, sales or other expenses, including referral fees, to attract new customers, which will offset revenues from such customers. For these and other reasons, Nauticus could fail to achieve revenue growth, which could adversely affect its results of operations, prospects and financial condition.

If customers or their employees do not perceive Nauticus' product and service offerings to be of value, Nauticus may not be able to attract and retain customers and customers may fail to purchase additional units or renew their RaaS subscriptions. If Nauticus' efforts to satisfy and retain its existing customers are not successful, it may not be able to attract customers, and as a result, its ability to maintain and/or grow its business will be adversely affected. Customers may fail to purchase additional units or cancel Nauticus' subscription/contracts for many reasons including inadequate customer service or maintenance and servicing issues that are not satisfactorily resolved. Customer retention will also be largely dependent on the quality and effectiveness of Nauticus' customer service and maintenance and servicing operations, which may be handled internally by Nauticus' personnel and also by third-party service providers. Outsourcing of certain customer service and claims administration or maintenance and servicing functions may reduce Nauticus' ability to ensure consistency in its overall customer service processes. If Nauticus is unable to successfully retain existing customers and attract new customers, Nauticus' business, prospects, financial condition and operating results will be adversely affected.

Even if Nauticus successfully markets its products and services, the purchase or subscription, adoption and use of the products and services may be materially and negatively impacted if Nauticus' customers resist the use and adoption of the products and services.

Nauticus has designed and developed its robotic systems with the goal of reducing operating costs and greenhouse gases through the use of smaller surface vessels (Hydronaut) and all electric robot subsystems. Even if Nauticus successfully markets its products and services to customers, the purchase or subscription, adoption and the use of the products and services may be materially and negatively impacted if Nauticus' customers resist or delay the use and adoption of these new technology products and services. Customers may resist or delay the adoption of Nauticus' products and services for several reasons, including lack of confidence in autonomous and semi-autonomous ocean vehicles. Nauticus will spend significant time and resources on beta units of its Aquanaut for customer testing. If Nauticus' customers resist or delay adoption of Nauticus' ocean robotic platforms, Nauticus' business, prospects, financial condition and operating results will be materially and adversely affected.

Nauticus' RaaS subscription model (planned for future commercial services but yet to be implemented) has yet to be tested and may fail to gain commercial acceptance.

Nauticus' ability to derive revenue from its products depends on its ability to successfully market its products and develop a network of ongoing customers for its new RaaS revenue model. Investors should be aware of the difficulties normally encountered by a new business model, many of which are beyond Nauticus' control, including substantial risks and expenses while establishing or entering new markets, setting up operations and undertaking marketing activities. There can be no assurance that customers will perceive benefits to the RaaS subscription model.

Because Nauticus will continue to own units while they are used by the customers, Nauticus will be subject to risks associated with ongoing ownership of the units, including the risks of deterioration, damage or theft and higher maintenance and servicing costs. All of these could result in higher costs to Nauticus, and could lead to customer dissatisfaction. The likelihood of Nauticus' success must be considered in light of these risks, expenses, complications, delays, and the competitive environment in which Nauticus operates. There is, therefore, nothing at this time upon which to base an assumption that Nauticus' RaaS business model will prove successful.

If Nauticus is successful in commercializing its products and services, Nauticus' revenue will be concentrated in a limited number of models for the foreseeable future.

If Nauticus is successful in commercializing its products and services, its revenue will be concentrated in a limited number of models for the foreseeable future. Nauticus launched the Aquanaut platform in 2021 and expects to launch the commercial production versions of the Aquanaut robotic system under the RaaS business model by the end of 2022. Such timeline may be delayed, including due to challenges in recruiting skilled employees, difficulties in securing components and materials, development delays, difficulties relating to manufacturing of the units and other factors. Such challenges may result in delay of the anticipated commercial launch of one or more of the products and services, which would adversely affect Nauticus' financial and operating results. To the extent Nauticus' products and services do not meet customer expectations, or cannot be completed or manufactured or delivered on their projected timelines and in line with cost and volume targets, Nauticus' future sales and operating results may be adversely affected. Given that for the foreseeable future Nauticus' business will depend on a limited number of product models, to the extent a particular product model is not well-received by the market, Nauticus' revenue could be materially and adversely affected. This could have a material adverse effect on Nauticus' business, prospects, financial condition and operating results.

Nauticus may not be able to complete or enhance its product and service offerings through its research and development efforts.

To commercially launch the RaaS business model, Nauticus will need to continue to advance and evolve its products in response to the evolving demands of its customers in the various industries it expects to serve. Nauticus expects to launch newer versions of two (2) subsea vehicle products by the end of 2022: the Aquanaut, a mobile subsea robotic system, and the Argonaut, a defense-oriented subsea vehicle. Each of these products and setup of associated services will require significant additional expenses, and Nauticus may not be successful in commercializing or marketing such products and services at all or within the currently expected timeline.

In addition, notwithstanding Nauticus' market research efforts, its future products and services may not be accepted by customers or their employees. The success of any proposed product and service offerings will depend on numerous factors, including Nauticus' ability to:

- attract, recruit and retain qualified personnel, including engineers, design and production personnel and service technicians;
- identify the preferred product and service features in multiple industries, such as offshore wind energy, defense, and subsea oil and gas and successfully incorporate those features into its products;
- develop and introduce proposed products and services in sufficient quality and quantities and in a timely manner;
- adequately protect its intellectual property and avoid infringing upon the intellectual property rights of third parties; and
- demonstrate the cost savings and efficacy of the proposed products and services.

Nauticus has managed and expects to continue to manage its product development efforts through the development of alpha units, beta units and commercial units. If Nauticus fails to adequately communicate to customers the improvements that are expected from one development stage to the next, or if customer feedback from one development stage is not adequately reflected in the next, customers may not be persuaded of the value of Nauticus' products and services. If Nauticus fails to generate demand by developing products that incorporate features desired by customers, Nauticus may fail to generate RaaS subscriptions sufficient to achieve or maintain profitability. Nauticus has in the past experienced, and may in the future experience, delays in various phases of product development, including during research and development, manufacturing, limited release testing, marketing and customer education efforts. Further, delays in product development would postpone demonstrations and customer testing, important opportunities for customer engagement, and cause Nauticus to miss expected timelines. Such delays could cause customers to delay or forgo purchases of or subscriptions to Nauticus' products and services, or to purchase or subscribe for competitors' products and services. Even if Nauticus is able to successfully develop proposed products when anticipated, these products and their related services may not produce revenue in excess of the costs of development and service, and they

may be quickly rendered obsolete by changing customer preferences or the introduction by competitors of products and services embodying new technologies or features. If Nauticus is unable to successfully manage its product development and communications with customers, customers may choose to not adopt, to cancel or to not renew RaaS subscriptions, which would adversely affect Nauticus' business, prospects, financial condition, and operating results.

Defects, glitches, or malfunctions in Nauticus' products or the software that operates them, failure of its products to perform as expected, connectivity issues or operator errors, result in product recalls, lower than expected return on investment for customers, cause harm to operators and significant safety concerns, each of which could adversely affect Nauticus' results of operations, financial condition and its reputation.

The design, manufacture, and marketing of Nauticus' products involve certain inherent risks. Manufacturing or design defects, glitches, malfunctions, connectivity issues between the central processing unit and peripheral vehicle subsystems, unanticipated use of Nauticus' robotic systems, operator errors or inadequate disclosure of risks relating to the use of ocean robotic systems, among others, can lead to injury, property damage or other adverse events. Nauticus conducts extensive testing of its units, in some instances in collaboration with its customers, to ensure that any such issues can be identified and addressed in advance of commercial launch of the products. However, there can be no assurance that Nauticus will be able to identify all such issues or that, if identified, efforts to address them will be effective in all cases.

In addition, if the manufacturing of Nauticus' products is outsourced, Nauticus may not be aware of manufacturing defects that could occur. Such adverse events could lead to unexpected failures in Nauticus' products and could result, in certain cases, in the removal of its products from the market. A product recall could result in significant costs. To the extent any manufacturing defect occurs, Nauticus' agreement with the third-party manufacturer may contain a limitation on the third-party manufacturer's liability, and therefore Nauticus could be required to incur the majority of related costs. Product defects or recalls could also result in negative publicity, damage to Nauticus' reputation or, in the event of regulatory developments, delays in new product acceptance.

Nauticus' products incorporate sophisticated computer software. Complex software frequently contains errors, especially when first introduced. Nauticus' software may experience errors or performance problems in the future. If any part of Nauticus' products' hardware or software were to fail, the service mission could be compromised. Additionally, users may not use Nauticus' products in accordance with safety protocols and training, which could amplify the risk of failure. Customers and users also may fail to install updates and fixes to the software for several reasons including poor connectivity or inattention. Any such occurrence could cause delay in market acceptance of Nauticus' products, damage to its reputation, product recalls, increased service and warranty costs, product liability claims and loss of revenue relating to such hardware or software defects.

Nauticus anticipates that as part of its ordinary course of business it may be subject to product liability claims alleging defects in the design or manufacture of its products. A product liability claim, regardless of its merit or eventual outcome, could result in significant legal defense costs and high punitive damage payments. Although Nauticus maintains product liability insurance, the coverage is subject to deductibles and limitations, and may not be adequate to cover future claims. Additionally, Nauticus may be unable to maintain its existing product liability insurance in the future at satisfactory rates or adequate amounts.

Even if Nauticus' products perform properly and are used as intended, if operators sustain any injuries while using Nauticus' products, Nauticus could be exposed to liability and its results of operations, financial condition, and its reputation may be adversely affected.

Nauticus' products contain complex technology and must be used as designed and intended in order to operate safely and effectively. While Nauticus expects to develop a training, customer service and maintenance and servicing infrastructure to ensure users are equipped to operate its products in a safe manner, it cannot be sure that the products will ultimately be used as designed and intended. In addition, Nauticus cannot be sure that it will be able to predict all the ways in which use or misuse of the products can lead to injury or damage to property, and its training resources may not be successful at preventing all incidents. If operators were to sustain any injuries or cause any damage to property while using Nauticus' products, in a manner consistent with Nauticus' training and instructions or otherwise, Nauticus could be exposed to liability and its results of operations, financial condition and its reputation may be adversely affected.

Nauticus has no experience maintaining or servicing its products at a large scale.

Under the RaaS subscription (planned for future commercial services but yet to be implemented) or conventional service contract model, Nauticus will be responsible for maintenance and servicing of the units. However, Nauticus has no experience providing maintenance and servicing on a global scale. Nauticus may elect to partner with one or more third parties to perform some or all of the servicing and maintenance on its products, but there can be no assurance that Nauticus will be able to enter into an acceptable arrangement with any such third-party provider. Although such servicing partners may have experience in servicing complex machinery, they will initially have limited experience in servicing Nauticus' ocean vehicles. If Nauticus is unable or elects not to enter into a partnership with third parties to perform maintenance and servicing, it would be required to provide such services directly, which would significantly increase Nauticus' capital expenditures and personnel costs. Nauticus would also be required to recruit and train employees to provide these services and it may not be able to attract persons with the necessary knowledge or experience to provide these services. Delays in implementing a maintenance and servicing infrastructure may significantly delay new RaaS subscriptions due to smaller than expected maintenance and servicing capacity.

In addition, there can be no assurance that Nauticus' service and maintenance arrangements will adequately address the service and maintenance requirements of its customers to their satisfaction, or that Nauticus and its servicing partners will have sufficient resources, experience or inventory to meet these service requirements in a timely manner as the volume of robotic systems Nauticus delivers increases. Even if Nauticus and its servicing partners have the sufficient resources and experience needed, they still may not adequately service or maintain the units. If Nauticus is unable to, directly or through third party partners, roll out and establish a widespread service network, including on-site services, customer satisfaction could be adversely affected, which in turn could materially and adversely affect Nauticus' reputation and thus its sales, results of operations and prospects.

Nauticus' customers will also depend on Nauticus' customer support team to resolve technical and operational issues relating to the integrated software underlying Nauticus' ocean robotic systems. In addition, the RaaS subscription model will require Nauticus to cover costs relating to servicing and maintenance of the robotic systems. Customer behavior and usage may result in higher than expected maintenance and repair costs. Moreover, if RaaS customers do not pay the subscription fee while the units are out of service, there could be an adverse impact on Nauticus' financial condition and operating results.

As Nauticus continues to grow, additional pressure may be placed on Nauticus' customer support team or partners, and Nauticus may be unable to respond quickly enough to accommodate short-term increases in customer demand for technical support. Nauticus also may be unable to modify the future scope and delivery of its technical support to compete with changes in the technical support provided by its competitors. Increased customer demand for support, without corresponding revenue, could increase costs and negatively affect Nauticus' operating results. If Nauticus is unable to successfully address the service requirements of its customers or establish a market perception that Nauticus does not maintain high-quality support, Nauticus may be subject to claims from its customers, including loss of revenue or damages, and Nauticus' business, prospects, financial condition and operating results may be materially and adversely affected.

Nauticus' ability to manufacture products of sufficient quality on schedule is unproven, and delays in the design, production and launch of its products could harm its business, prospects, financial condition and operating results.

Nauticus' future business depends in large part on its ability to execute its plans to design, develop, manufacture, market, deploy and service its products. Nauticus intends to outsource the manufacturing of its ocean robotic systems to a third-party manufacturing partner. While this arrangement may lower operating costs, it also reduces Nauticus' direct control over production and manufacturing. Such diminished control may have an adverse effect on the quality or quantity of Nauticus' units, or Nauticus' flexibility to respond to changing conditions.

Nauticus also plans to retain third-party vendors and service providers to engineer, design and test some of the critical systems and components of Nauticus' units. While this allows Nauticus to draw from such third parties' industry knowledge and expertise, there can be no assurance such systems and components will be successfully developed to Nauticus' specifications or delivered in a timely manner to meet Nauticus' program timing requirements.

[Table of Contents](#)

Nauticus' continued development and manufacturing of its commercially available robotic system, Aquanaut, and its future models, including Argonaut, are and will be subject to risks, including with respect to:

- costs to be incurred by Nauticus and/or any third-party manufacturing partner or partners in meeting Nauticus specifications and design tolerances;
- the ongoing effects of the COVID-19 pandemic or other pandemics, epidemics or outbreaks;
- hiring and retaining a sufficient number of qualified employees. Nauticus has historically been understaffed due to these challenges;
- long- and short-term durability of Nauticus' ocean robotic systems to withstand day-to-day wear and tear;
- delays in delivery of final systems and components by Nauticus' suppliers;
- manufacturing of robotic systems units in excess of demand due to contractual requirements or unexpected changes in demand;
- shifts in demand for future models;
- quality controls, particularly as Nauticus' plans to expand its production capabilities;
- delays or disruptions in Nauticus' supply chain, or the need to order supplies in excess of demand due to batch number requirements or price thresholds;
- work stoppages, labor strikes and other labor disputes affecting Nauticus or its suppliers, third-party manufacturers and other partners; and
- other delays and cost overruns.

Nauticus is or may be subject to risks associated with strategic alliances or acquisitions and may not be able to identify adequate strategic relationship opportunities, or form strategic relationships, in the future.

Nauticus may seek to enter into strategic alliances, joint ventures, minority equity investments, acquisitions, collaborations and in-license arrangements. There is no guarantee that any of these partnerships or acquisitions would lead to any binding agreements or lasting or successful business relationships with third parties. If any of these relationships are established, they may subject Nauticus to a number of risks, including risks associated with sharing proprietary information, non-performance by the third-party and increased expenses in establishing new relationships, any of which may materially and adversely affect Nauticus' business. Nauticus may have limited ability to monitor or control the actions of these third parties and, to the extent any of these strategic third parties suffers negative publicity or harm to their reputation from events relating to their business, Nauticus may also suffer negative publicity or harm to its reputation by virtue of its association with any such third-party.

Strategic business relationships will be an important factor in the growth and success of Nauticus' business. However, there are no assurances that Nauticus will be able to identify or secure suitable business relationship opportunities in the future or Nauticus' competitors may capitalize on such opportunities before Nauticus does. Moreover, identifying such opportunities could require substantial management time and resources, and negotiating and financing relationships involves significant costs and uncertainties. If Nauticus is unable to successfully source and execute on strategic relationship opportunities in the future, its overall growth could be impaired, and its business, prospects, financial condition and operating results could be materially adversely affected.

When appropriate opportunities arise, Nauticus has in the past, and may in the future acquire additional assets, products, technologies or businesses that are complementary to its existing business. From time to time, the sellers of these assets, products and technologies or business may retain limited rights to the technology that they sell to us, which in some circumstances could allow the sellers to compete with us in a limited fashion. In addition to possible stockholder approval, Nauticus may need approvals and licenses from relevant government authorities for the acquisitions and to comply with any applicable laws and regulations, which could result in increased delay and costs, and may disrupt Nauticus' business strategy if it fails to do so. Furthermore, acquisitions and the subsequent integration of new assets and businesses into Nauticus' own require significant attention from Nauticus' management and could result in a diversion of resources from Nauticus' existing business, which in turn could have an adverse

effect on Nauticus' operations and financial results. Acquired assets or businesses may not generate the financial results Nauticus expects. Acquisitions could result in the use of substantial amounts of cash, potentially dilutive issuances of equity securities, the occurrence of significant goodwill impairment charges, amortization expenses for other intangible assets and exposure to potential unknown liabilities of the acquired business. Moreover, the costs of identifying and consummating acquisitions may be significant.

Nauticus is highly dependent on the services of its senior management and other key employees and, if Nauticus is unable to attract and retain a sufficient number of qualified employees, its ability to design, manufacture and launch its products, operate its business and compete could be harmed.

Nauticus' success depends, in part, on its ability to retain its key personnel. Nauticus expects that it will be required to increase compensation levels of senior management and key employees to remain competitive with its peers. The unexpected loss of or failure to retain one or more of Nauticus' senior managers or other key employees could delay product development and require outsourcing to third parties, each of which in turn could adversely affect Nauticus' business. Nauticus' success also depends, in part, on its continuing ability to identify, hire, attract, train and develop other highly qualified personnel. Experienced and highly skilled employees are in high demand and competition for these employees can be intense, and Nauticus' ability to hire, attract and retain them depends on its ability to provide competitive compensation. Nauticus may not be able to attract, assimilate, develop or retain qualified personnel in the future, and its failure to do so could adversely affect Nauticus' business, including the execution of its strategy. Any failure by Nauticus' management team and Nauticus' employees to perform as expected may have a material adverse effect on Nauticus' business, prospects, financial condition and operating results.

Nauticus' management as a group has limited experience in operating a public company.

Nauticus' management team may not successfully or effectively manage its transition to a public company that will be subject to significant regulatory oversight and reporting obligations under federal securities laws. Nauticus' executive officers as a group have limited experience in the management of a publicly traded company. Their limited experience in dealing with the increasingly complex laws pertaining to public companies could be a significant disadvantage in that it is likely that an increasing amount of their time may be devoted to these activities which will result in less time being devoted to the management and growth of the post-combination company. Nauticus will need to recruit additional persons to join its management team in order to handle the increased demands of running a public company, but its efforts may not be successful. Nauticus may not have adequate personnel with the appropriate level of knowledge, experience and training in the accounting policies, practices or internal control over financial reporting required of public companies. Any failure by Nauticus' management team to perform as expected may have a material adverse effect on Nauticus' business, prospects, financial condition, and operating results.

Nauticus will incur significant increased expenses and administrative burdens as a public company, which could have a material adverse effect on its business, prospects, financial condition and operating results.

If Nauticus completes the Business Combination and becomes a public company, it will incur significant legal, accounting and other expenses that it did not incur as a private company, and these expenses may increase even more after Nauticus' is no longer an emerging growth company, as defined in Section 2(a) of the Securities Act. As a public company, Nauticus will be subject to the reporting requirements of the Exchange Act, the Sarbanes-Oxley Act, the Dodd-Frank Wall Street Reform and Consumer Protection Act, as well as rules adopted, and to be adopted, by the SEC and Nasdaq. Nauticus' management and other personnel will need to devote a substantial amount of time to these compliance initiatives. It is possible that Nauticus will be required to expand its employee base and hire additional employees to support its operations as a public company which will increase its operating costs in future periods. Moreover, Nauticus expects these rules and regulations to substantially increase its legal and financial compliance costs and to make some activities more time-consuming and costly. The increased costs will increase Nauticus' net loss. For example, Nauticus expects it to become more difficult and more expensive for it to obtain director and officer liability insurance and it may be forced to incur substantially higher costs to obtain appropriate coverage. Nauticus cannot accurately predict or estimate the amount or timing of additional costs it may incur. The impact of being a public company could also make it more difficult for Nauticus to attract and retain qualified persons to serve on its board of directors, its board committees or as executive officers. Such increased expenses and administrative burdens involved in operating as a public company could have a material adverse effect on Nauticus' business, prospects, financial condition, and operating results.

Ongoing impacts from COVID-19 or another pandemic, epidemic or outbreak of an infectious disease may materially and adversely impact Nauticus' business, prospects, financial condition and operating results.

The ongoing COVID-19 pandemic as well as other possible health pandemics, epidemics or outbreaks may materially and adversely impact Nauticus' business, prospects, financial condition, and operating results. Nauticus' engineering and product development operations, among others, cannot all be conducted in a remote working structure and often require on-site access to materials and equipment. Nauticus has customers with international operations in varying industries. It also depends on suppliers and manufacturers worldwide.

Depending upon the duration of the ongoing COVID-19 pandemic and the associated business interruptions, its customers, suppliers, manufacturers and partners may suspend or delay their engagement with Nauticus, which could result in a material adverse effect on its financial condition and ability to meet current timelines. The COVID-19 pandemic has affected and may continue to affect Nauticus' ability to recruit skilled employees to join its team. Nauticus' response to the ongoing COVID-19 pandemic may prove to be inadequate and it may be unable to continue its operations in the manner it had prior to the outbreak, and may endure interruptions, reputational harm, delays in its product development and shipments, all of which could have an adverse effect on its business, prospects, financial condition and operating results. In addition, when the pandemic subsides, Nauticus cannot assure you as to the timing of any economic recovery, which could continue to have a material adverse effect on its target markets and its business.

The ongoing military action between Russia and Ukraine could adversely affect our business, financial condition and operating results.

On February 24, 2022, Russian military forces launched a military action in Ukraine, and sustained conflict and disruption in the region is likely. Although the length, impact and outcome of the ongoing military conflict in Ukraine is highly unpredictable, this conflict could lead to significant market and other disruptions, including significant volatility in commodity prices and supply of energy resources, instability in financial markets, supply chain interruptions, political and social instability, changes in consumer or purchaser preferences as well as increase in cyberattacks and espionage.

Russia's recognition of two separatist republics in the Donetsk and Luhansk regions of Ukraine and subsequent military action against Ukraine have led to an unprecedented expansion of sanction programs imposed by the United States, the European Union, the United Kingdom, Canada, Switzerland, Japan and other countries against Russia, Belarus, the Crimea Region of Ukraine, the so-called Donetsk People's Republic and the so-called Luhansk People's Republic, including, among others:

- blocking sanctions against some of the largest state-owned and private Russian financial institutions (and their subsequent removal from the Society for Worldwide Interbank Financial Telecommunication ("SWIFT") payment system) and certain Russian businesses, some of which have significant financial and trade ties to the European Union;
- blocking sanctions against Russian and Belarusian individuals, including the Russian President, other politicians and those with government connections or involved in Russian military activities; and
- blocking of Russia's foreign currency reserves as well as expansion of sectoral sanctions and export and trade restrictions, limitations on investments and access to capital markets and bans on various Russian imports.

While we do not currently have operations in Ukraine, Russia or Belarus, we are nevertheless actively monitoring the situation in Ukraine and assessing its impact on our business, including our business partners and customers. To date we have not experienced any material interruptions in our infrastructure, supplies, technology systems or networks needed to support our operations. We have no way to predict the progress or outcome of the conflict in Ukraine or its impacts in Ukraine, Russia or Belarus as the conflict, and any resulting government reactions, are rapidly developing and beyond our control. The extent and duration of the military action, sanctions and resulting market disruptions could be significant and could potentially have substantial impact on the global economy and our business for an unknown period of time. Any of the abovementioned factors could affect our business, financial condition and operating results. Any such disruptions may also magnify the impact of other risks described herein.

Nauticus may become subject to new or changing governmental regulations relating to the design, manufacturing, marketing, distribution, servicing, or use of its products, and a failure to comply with such regulations could lead to withdrawal or recall of Nauticus' products from the market, delay Nauticus' projected revenues, increase cost, or make Nauticus' business unviable if it is unable to modify its products to comply.

Nauticus may become subject to new or changing international, federal, state and local regulations, including laws relating to the design, manufacturing, marketing, distribution, servicing or use of its products. Such laws and regulations may require Nauticus to pause sales and modify its products, which could result in a material adverse effect on its revenues and financial condition. Such laws and regulations can also give rise to liability such as fines and penalties, property damage, bodily injury and cleanup costs. Capital and operating expenses needed to comply with laws and regulations can be significant, and violations may result in substantial fines and penalties, third-party damages, suspension of production or a cessation of Nauticus' operations. Any failure to comply with such laws or regulations could lead to withdrawal or recall of Nauticus' products from the market.

Nauticus may experience significant delays in the design, development, production and launch of its ocean robotic systems, which could harm its business, prospects, financial condition and operating results.

Nauticus' core products, including the Argonaut, Aquanaut, Olympic Arm and ToolKITT, are currently offered through direct sales and will be offered for lease through RaaS when available, Nauticus expects that the nature of these products will require continuous improvements and further testing throughout their product and generational lifecycle in order to innovate and develop these products fully. Manufacturing and deliveries of the Aquanaut, to public commercial clients, are not expected to begin until the end of 2022, and may occur later or not at all. Such timeline may be delayed, including due to challenges in recruiting skilled employees, difficulties in securing components and materials, development delays, difficulties relating to manufacturing of the units and other factors. Any delay in the design, development, production and release of Nauticus' products could materially damage Nauticus' brand, business, prospects, financial condition and operating results. Nauticus may experience delays in the design, development, production and release of new products, including due to integration, safety and performance issues. To the extent Nauticus delays the commercial launch of its ocean robotic systems, its growth prospects and operating results will likely be adversely affected.

Nauticus has no experience to date in high volume manufacture of its products nor does it have the facility, employees or equipment needed to manufacture its products in high volume.

Nauticus intends to enter into contracts with one or more third-party manufacturers to produce Nauticus' ocean vehicles. Nauticus does not know whether its future third-party manufacturers will be able to develop efficient, automated, low-cost production capabilities and processes and reliable sources of component supply, that will enable Nauticus to meet the quality, price, engineering, design and production standards, as well as the production volumes, required to successfully market Nauticus' robotic systems. Even if Nauticus and its third-party manufacturers are successful in developing its production capability and processes and reliably source its components, Nauticus does not know whether it will be able to do so in a manner that avoids significant delays and cost overruns, including as a result of factors beyond its control such as problems with suppliers and vendors, or force majeure events, or in time to meet Nauticus' unit commercialization schedules or to satisfy the requirements of customers and potential customers.

If Nauticus is unable to enter into agreements with third-party manufacturers on acceptable terms, it will need to develop its own manufacturing and production capabilities, significantly increasing Nauticus' capital expenditures and delaying production of Nauticus' ocean robotic systems. If this were to occur, Nauticus would need raise or borrow additional money, which may not be successful, and possibly change the anticipated pricing of its RaaS subscription model, which would adversely affect Nauticus' margins and cash flows.

Any failure to develop production processes and capabilities within Nauticus' projected costs and timelines could have a material adverse effect on Nauticus' business, prospects, financial condition and operating results.

The period of time from initial design of Nauticus' products to obtaining binding purchase commitments from customers is long and Nauticus is subject to the risk that customers who initially expressed an interest in its products during the design phase will not enter into binding commitments.

Nauticus' products contain complex technology that requires multiple years of engineering and design. Therefore, the period of time from initial design of Nauticus' products to obtaining binding purchase commitments from customers is long and Nauticus is subject to the risk that customers who initially expressed an interest in its products during the design phase will not enter into binding commitments. Nauticus' design of its products is significantly influenced by feedback from potential customers and reflect the needs they expressed. As a result, adapting Nauticus' products to other industries or customers may require additional design, development, testing, work and expenses. Nauticus cannot be sure that it will be able to adapt its products to reflect such feedback successfully or at all. If customers who initially express an interest in Nauticus' proposed products and influenced their design ultimately decide to not enter into binding commitments or to adopt a competitors' technology, Nauticus' business, prospects, financial condition and operating results would be adversely affected.

Nauticus' ability to control costs and liability is dependent on developing sufficient screening criteria for its RaaS customers.

Nauticus' ability to realize revenue and reduce liability related to its RaaS subscription model (planned for future commercial services but yet to be implemented) is heavily dependent on its ability to effectively screen customers for high risk activities or environments that could result in higher costs for Nauticus. Nauticus has limited experience with its RaaS subscription model, a service planned for future commercial use but yet to be implemented, and may not be able to effectively develop effective customer screening criteria. Nauticus may need to rely on third-party service providers to develop effective screening criteria, which will result in additional cost to Nauticus. Nauticus' screening criteria may also need to be adjusted over time to satisfy requirements under applicable law, from its insurers, lenders or from other third-party service providers. Nauticus must balance the need to develop effective screening criteria with its need to attract new customers or market to different industry segments.

Nauticus' business and prospects depend significantly on its ability to build the Nauticus brand. Nauticus may not succeed in continuing to establish, maintain and strengthen the Nauticus brand, and its brand and reputation could be harmed by negative publicity regarding Nauticus or its products.

Nauticus' business and prospects are heavily dependent on its ability to develop, maintain and strengthen the Nauticus brand. If Nauticus does not continue to establish, maintain and strengthen its brand, it may lose the opportunity to build a critical mass of customers. Promoting and positioning its brand will likely depend significantly on Nauticus' ability to provide high quality products and engage with its customers as intended. In addition, Nauticus' ability to develop, maintain and strengthen the Nauticus brand may depend on the acceptance of its products by employees of its customers. To promote its brand, Nauticus may be required to change its customer development and branding practices, which could result in substantially increased expenses, including the need to use traditional media including print media. If Nauticus does not develop and maintain a strong brand, its business, prospects, financial condition and operating results will be materially and adversely impacted.

In addition, if incidents occur or are perceived to have occurred, whether or not such incidents are Nauticus' fault, Nauticus could be subject to adverse publicity. In particular, given the popularity of social media, any negative publicity, whether true or not, could quickly proliferate and harm perceptions and confidence in the Nauticus brand. Furthermore, there is the risk of potential adverse publicity related to Nauticus' manufacturing or other partners whether or not such publicity is related to their collaboration with Nauticus. Nauticus' ability to successfully position its brand could also be adversely affected by perceptions about the quality of its competitors' products.

Nauticus is dependent on its suppliers, some of which are currently single or limited source suppliers, and the inability of these suppliers to deliver necessary components of Nauticus' products at prices and volumes, performance and specifications acceptable to Nauticus, could have a material adverse effect on Nauticus' business, prospects, financial condition and operating results. Nauticus has not yet identified all of the suppliers that it is likely to rely on to support any future commercialization of its core products.

Nauticus relies on third-party suppliers for the provision and development of many of the key components and materials used in its products. Nauticus has not yet identified all of the suppliers, contractors and other third parties that it is likely to rely on to support any future commercialization of its core products. While Nauticus plans to obtain

[Table of Contents](#)

components from multiple sources whenever possible, some of the components used in its products may have to be purchased by Nauticus from a single source. If Nauticus' third-party suppliers are unable to supply key components and materials at the required volume, Nauticus' sales, revenues and profitability will likely be adversely affected. Nauticus' third-party suppliers may also not be able to meet the specifications and performance characteristics required by Nauticus, which would impact Nauticus' ability to achieve its product specifications and performance characteristics as well. Additionally, Nauticus' third-party suppliers may be unable to obtain required certifications for their products for which Nauticus plans to use or provide warranties that are necessary for Nauticus' solutions. If Nauticus is unable to obtain components and materials used in its products from its suppliers, Nauticus' business would be adversely affected.

Nauticus has less negotiating leverage with suppliers than larger and more established companies and may not be able to obtain favorable pricing and other terms. For example, agreements with suppliers may include terms that are unfavorable to Nauticus, such as requirements that Nauticus order components and manufacturing units in excess of Nauticus' demand due to batch number requirements or price thresholds. While Nauticus believes that it may be able to establish alternate supply relationships and can obtain or engineer replacement components for its single source components, Nauticus may be unable to do so in the short term, or at all, at prices or quality levels that are favorable to Nauticus, which could have a material adverse effect on its business, prospects, financial condition and operating results.

Moreover, Nauticus and its suppliers are currently experiencing increases in the cost of, and an interruption in, the supply or shortage of materials. It is unclear how long these challenges will remain. Due to the complexity of Nauticus' products, each unit is expected to contain several thousand components. Difficulty securing any components and materials could result in delays in the development of these core products, which delays could be compounded if components or units require redesign or reengineering. Any sustained increase, supply interruption or shortage could therefore prevent or delay the commercialization of Nauticus' products and materially and negatively impact Nauticus' business, prospects, financial condition and operating results. Nauticus and its suppliers use various materials in their businesses and products, including for example semiconductors, energy storage materials, commodity materials and specialty metal alloys, and the prices for these materials fluctuate. The available supply of some of these materials and components is currently and may continue to be unstable, depending on market conditions and global demand, and could adversely affect Nauticus' business and operating results. Risks relating to Nauticus' supply chain include:

- "Buy American" or other similar requirements that may be imposed on government contractors;
- an increase in the cost, or decrease in the available supply, of semiconductor chips, electrical components, commodity materials and specialty alloys;
- disruption in the supply of lithium ion batteries due to quality issues or recalls; and
- fluctuations in the value of any foreign currencies in which manufactured parts, commercial components and related raw material purchases are or may be denominated against the U.S. dollar.

Nauticus' business is also dependent on the continued supply of lithium ion battery cells. While Nauticus believes several sources of cells are available, Nauticus has to date not finally sourced or validated a supplier for its commercial production and it may have limited flexibility in changing cell suppliers once contracted. Any disruption in the supply of battery cells from such suppliers could disrupt production of Nauticus' products. Furthermore, fluctuations or shortages in raw materials or components and other economic conditions may cause Nauticus to experience significant increases in freight charges and material costs. Substantial increases in the prices for Nauticus' materials or prices charged to it, such as those charged by battery cell suppliers, would increase Nauticus' operating costs, and could reduce its margins if the increased costs cannot be recouped through increased RaaS subscription offering or unit sales prices. Any attempts to increase product prices in response to increased material costs could result in cancellations of orders and reservations and therefore materially and adversely affect Nauticus' brand, image, business, prospects, financial condition and operating results.

Nauticus' potential transition to an outsourced manufacturing business model may not be successful, which could harm its ability to deliver products and recognize revenue.

Nauticus intends to transition from a manufacturing model in which it primarily manufactured and assembled its products at a smaller scale at its existing Webster, Texas location, to one where it relies on one or more third-party manufacturers. Nauticus is in negotiations with third parties to provide contract manufacturing of its products. Moreover, Nauticus may not be able to contract with potential counterparties on commercially reasonable terms or at all. Nauticus believes the use of third-party manufacturers will have benefits, but in the near term, while it is beginning manufacturing with one or more new partners, Nauticus may lose revenue and incur increased costs.

Reliance on third-party manufacturers reduces Nauticus' control over the manufacturing process, including reduced control over quality, product costs and product supply and timing. Nauticus may experience delays in shipments or issues concerning product quality from its third-party manufacturers. If any of Nauticus' third-party manufacturers experience interruptions, delays or disruptions in supplying its products, including by natural disasters, the global COVID-19 pandemic, other health epidemics and outbreaks, or work stoppages or capacity constraints, Nauticus' ability to ship products to distributors and customers would be delayed. In addition, unfavorable economic conditions could result in financial distress among third-party manufacturers upon which Nauticus relies, thereby increasing the risk of disruption of supplies necessary to fulfil Nauticus production requirements and meet customer demands. While Nauticus takes measures to protect its trade secrets, the use of third-party manufacturers may also risk disclosure of its innovative and proprietary technologies, which could adversely affect Nauticus' business.

Additionally, if any of Nauticus' future third-party manufacturers experience quality control problems in their manufacturing operations and Nauticus' products do not meet customer requirements, Nauticus could be required to recall the units or cover the cost of repair or replacement of any defective products. These delays or product quality issues could have an immediate and material adverse effect on Nauticus' ability to fulfill orders and could have a negative effect on its operating results. In addition, such delays or issues with product quality could adversely affect Nauticus' reputation and its relationship with its customers.

If any third-party manufacturers experience financial, operational, manufacturing capacity or other difficulties, or experience shortages in required components, or if they are otherwise unable or unwilling to continue to manufacture Nauticus' products in required volumes or at all, Nauticus' supply may be disrupted, it may be required to seek alternate manufacturers and it may be required to re-design its products. It would be time-consuming, and could be costly and impracticable, to begin to use new manufacturers and designs, and such changes could cause significant interruptions in supply and could have an adverse effect on Nauticus' ability to meet its scheduled product deliveries and may subsequently lead to the loss of sales.

If Nauticus is unable to contract with a third-party manufacturing partner, Nauticus would need to develop its own manufacturing facilities, which may not be feasible and, if feasible, would significantly increase its capital expenditures and operating expenditures, and would significantly delay or inhibit production of its robotic systems.

Nauticus does not have a definitive agreement with a third-party manufacturing partner to commercially manufacture its robotic ocean vehicles and it may be unable to enter into such agreements with third-party manufacturing partners and other key suppliers for manufacturing on terms and conditions acceptable to Nauticus. Although negotiations are continuing with potential counterparties, Nauticus may not be able to contract with potential counterparties on commercially reasonable terms or at all. If Nauticus is unable to enter into such definitive agreements or is only able to do so on terms that are less commercially favorable to Nauticus, it may be unable to timely identify adequate strategic relationship opportunities, or form strategic relationships, and consequently, Nauticus may not be able to fully carry out its business plans. There can be no assurance that Nauticus would be able to partner with other third parties or establish its own production capacity to meet its needs on acceptable terms, or at all. The expense and time required to complete any transition and to assure that robotic systems manufactured at facilities of new third-party partners comply with Nauticus' quality standards and regulatory requirements would likely be greater than currently anticipated. If Nauticus needs to develop its own manufacturing and production capabilities, which may not be feasible, it would significantly increase Nauticus' capital and operating expenditures and would significantly delay production of Nauticus' robotic systems. This may require Nauticus to attempt to raise or borrow additional money, which may not be successful. Also, it may require Nauticus to change the anticipated pricing of its RaaS subscription offering, which would adversely affect Nauticus' margins and cash flows. Any of the foregoing could adversely affect Nauticus' business, prospects, financial condition and operating results. Accordingly, investors should not place undue reliance on Nauticus' statements about its production plans or their feasibility in the timeframe anticipated, or at all. Nauticus may not be able to implement its business strategy in the timeframe anticipated, or at all.

Nauticus may be unable to adequately control the costs associated with its operations.

Nauticus will require significant capital to develop and grow its business, including developing and producing its commercial robotic systems and other products, establishing or expanding design, research and development, production, sales and maintenance and service facilities and building Nauticus' brand. Nauticus has incurred and expects to continue incurring significant expenses which will impact its profitability, including research and development expenses, procurement costs, sales, marketing and distribution expenses as Nauticus builds its brand and markets its robotic systems, and general and administrative expenses as Nauticus scales its

operations, identifies and commits resources to investigate new areas of demand and incurs costs as a public company. In addition, Nauticus may incur significant costs servicing, maintaining and refurbishing its robotic ocean vehicles, and it expects that the cost to repair and service its robotic systems will increase over time as its vehicles age. Nauticus' ability to become profitable in the future will not only depend on its ability to complete the design and development of its robotic vehicles to meet projected performance metrics, identify and investigate new areas of demand and successfully market its robotic systems and RaaS subscription model, but also to sell, whether outright or through subscriptions, its ocean systems at prices needed to achieve its expected margins and control its costs, including the risks and costs associated with operating, maintaining and financing Nauticus' robotic systems. If Nauticus is unable to efficiently design, develop, manufacture, market, deploy, distribute and service its robotic systems in a cost-effective manner, Nauticus' margins, profitability and prospects would be materially and adversely affected.

Nauticus, any manufacturing partners, and suppliers may rely on complex machinery for production, which involves a significant degree of risk and uncertainty in terms of operational performance and costs.

Nauticus, any third-party manufacturing partners, and suppliers may rely on complex machinery for the production and assembly of Nauticus' robotic systems, which will involve a significant degree of uncertainty and risk in terms of operational performance and costs. Nauticus' facilities, and those of any third-party manufacturing partners and suppliers consist or are expected to consist of large-scale machinery combining many components. These components may suffer unexpected malfunctions from time to time and will depend on repairs and spare parts to resume operations, which may not be available when needed. Unexpected malfunctions of these components may significantly affect the intended operational efficiency. Operational performance and costs can be difficult to predict and are often influenced by factors outside of Nauticus' or any third-party manufacturing partners' and suppliers' control, such as, but not limited to, scarcity of natural resources, environmental hazards and remediation, costs associated with decommissioning of machines, labor disputes and strikes, difficulty or delays in obtaining governmental permits, damages or defects in electronic systems, industrial accidents, fire, seismic activity and natural disasters. Should operational risks materialize, it may result in the personal injury to or death of workers, the loss of production equipment, damage to production facilities, monetary losses, delays and unanticipated fluctuations in production, environmental damage, administrative fines, increased insurance costs and potential legal liabilities, all which could have a material adverse effect on Nauticus' business, prospects, financial condition and operating results.

Nauticus faces risks related to natural disasters, health epidemics and other outbreaks, which could significantly disrupt its operations.

Nauticus' facilities or operations or those of any third-party manufacturers or suppliers could be adversely affected by events outside of its or their control, such as natural disasters, wars, health epidemics, and other calamities. Although Nauticus has servers that are hosted both onsite and at an offsite location, its backup system runs nightly, but does not capture data on a real-time basis and it may be unable to recover certain data in the event of a server failure. Nauticus cannot assure you that any backup systems will be adequate to protect it from the effects of fire, floods, typhoons, earthquakes, power loss, telecommunications failures, break-ins, war, riots, terrorist attacks or similar events. Any of the foregoing events may give rise to interruptions, breakdowns, system failures, technology platform failures or internet failures, which could cause the loss or corruption of data or malfunctions of software or hardware as well as adversely affect Nauticus' ability to provide services.

Nauticus currently targets many customers that are large corporations with substantial negotiating power, exacting product standards and potentially competitive internal solutions. If Nauticus is unable to sell its products to these customers, its prospects and results of operations will be adversely affected.

Nauticus' expects that many of its potential customers will be large, multinational corporations with substantial negotiating power relative to Nauticus and, in some instances, may have internal solutions that are competitive to Nauticus' products. These large, multinational corporations also have significant development resources, which may allow them to acquire or develop independently, or in partnership with others, competitive technologies. Meeting the technical requirements and securing binding commitments from any of these companies will require a substantial investment of Nauticus' time and resources. Nauticus cannot assure you that its products will secure binding commitments from these or other companies or that it will generate meaningful revenue from the sales of its products to these key potential customers. If Nauticus' products are not selected by these large corporations or if these corporations develop or acquire competitive technology, it will have an adverse effect on Nauticus' business.

Nauticus operates in a competitive industry that is subject to rapid technological change, and Nauticus expects competition to increase.

Nauticus' product offerings compete in a broad competitive landscape that includes incumbent actors, and emerging players in the blue technology markets, particularly companies focused on deploying ocean services with large vessels, tethered hydraulic and hybrid-electric ROVs, survey and hovering AUVs, electric platforms, remote monitoring, and other autonomy and perception technologies applied to adjacent ocean markets including autonomous shipping and subsea mining.

A breakdown of the competitive landscape by Nauticus product area:

- Nauticus' electric ocean robots and software platform compete with other tethered hydraulic and electric remotely operated vehicles (ROVs) and autonomous underwater vehicles (AUVs) for performing inspection, maintenance, repair, and physical interventions of ocean assets for sectors including offshore wind, oil & gas, aquaculture, port management, and defense & intel markets.
- Nauticus' underlining autonomy software platform includes modern robotics and automation technologies for autonomous navigation, manipulation, data orchestration and compression, behavior and mission execution and could face additional competition from the automotive and aerospace sectors working to solve similar challenges in different markets. At the most basic level, these software platforms are similar in nature and Nauticus' software could also be reciprocated in additional markets outside of the blue technologies and ocean services space.
- Nauticus' RaaS model (a business model planned for future commercial services but yet to be implemented) faces a varied competitive landscape that not only includes long established and largely undifferentiated ocean services companies like Oceaneering International, Subsea7, and Saipem, but other emerging companies such as Ocean Infinity and Reach Subsea that are bringing new approaches to the markets targeted by Nauticus Robotics and may evolve to a competitive stature in these markets. Nauticus also faces competition from bluetech software companies like Seebyte, Greensea, and but as Nauticus expands markets could face more boarder competition from autonomy software automotive companies diversify into the ocean markets like Toyota, Tesla, or Uber.
- Nauticus' robotic platforms also compete with other unmanned vehicles manufactures offered by companies such as Saab, Forum, and Mitsubishi and traditional automation and robotics companies like ABB and Fanuc. These companies have products that are commercially available and in development. Nauticus expects some products currently in development to become commercially available in the next few years and present a competitive threat to Nauticus' products.

Nauticus' competitor base may change or expand as Nauticus continues to develop and commercialize its robotic systems in the future. These or other competitors may develop new technologies or products that provide superior results to customers or are less expensive than Nauticus' products. Nauticus' technologies and products could have reduced competitiveness by such developments.

Nauticus' competitors may respond more quickly to new or emerging technologies, undertake more extensive marketing campaigns, have greater financial, marketing, manufacturing and other resources than Nauticus does, or may be more successful in attracting potential customers, employees and strategic partners. In addition, potential customers could have long-standing or contractual relationships with competitors. Potential customers may be reluctant to adopt Nauticus' products, particularly if they compete with or have the potential to compete with, or diminish the need/utilization of products or technologies supported through these existing relationships. If Nauticus is not able to compete effectively, its business, prospects, financial condition, and operating results will be negatively impacted.

In addition, because Nauticus operates in a new market, the actions of its competitors could adversely affect its business. Adverse events such as product defects or legal claims with respect to competing or similar products could cause reputational harm to the ocean robotics market on the whole and, accordingly, Nauticus' business.

Nauticus' financial results may vary significantly from period to period due to fluctuations in its operating costs, product demand and other factors.

Nauticus expects its period-to-period financial results to vary based on its operating costs and product demand, which Nauticus anticipates will fluctuate as the pace at which it continues to design, develop and manufacture new robotic systems, increase production capacity and establish or expand design, research and development, production, sales and service facilities. Additionally, Nauticus' revenues from period to period may fluctuate as it identifies and investigates areas of demand, adjusts volumes and adds new product derivatives based on market demand and margin opportunities, develops and introduces new robotic systems or introduces existing robotic systems to new markets for the first time, as well as the introduction of its RaaS subscription model (a business model planned

[Table of Contents](#)

for future commercial services that has yet to be implemented). As a result of these factors, Nauticus believes that quarter-to-quarter comparisons of its financial results, especially in the short term, are not necessarily meaningful and that these comparisons cannot be relied upon as indicators of future performance. Moreover, Nauticus' financial results may not meet expectations of equity research analysts, ratings agencies or investors, who may be focused only on quarterly financial results. If any of this occurs, the trading price of our securities following the Business Combination could fall substantially, either suddenly or over time.

If Nauticus fails to maintain an effective system of internal controls, its ability to produce timely and accurate financial statements or comply with applicable regulations could be adversely affected.

Nauticus expects that the requirements of the Exchange Act, the Sarbanes-Oxley Act and the rules and regulations of Nasdaq will continue to increase its legal, accounting and financial compliance costs, make some activities more difficult, time-consuming and costly, and place significant strain on personnel, systems and resources.

The Sarbanes-Oxley Act requires, among other things, that Nauticus maintain effective disclosure controls and procedures and internal control over financial reporting. Nauticus is continuing to develop and refine its disclosure controls, internal control over financial reporting and other procedures that are designed to ensure that information required to be disclosed by it in the reports that it will file with the SEC is recorded, processed, summarized and reported within the time periods specified in SEC rules and forms, and that information required to be disclosed in reports under the Exchange Act is accumulated and communicated to its principal executive and financial officers. Nauticus is in the process of upgrading its finance and accounting systems to an enterprise system suitable for a public company, and a delay could impact its ability or prevent it from timely reporting its operating results, timely filing required reports with the SEC and complying with Section 404 of the Sarbanes-Oxley Act. The development and implementation of the standards and controls necessary for Nauticus to achieve the level of accounting standards required of a public company may require costs greater than expected.

The current controls and any new controls that Nauticus develops may be inadequate because of changes in conditions of Nauticus' business. Further, weaknesses in its internal controls have been identified in connection with the preparation of financial statements for the years ended December 31, 2021 and 2020 and may be discovered in the future. As of March 31, 2022, Nauticus has filled positions of Senior Accountant and Accounts Receivable to remediate this weakness in its internal controls. In addition, Nauticus has recently added a Chief Financial Officer to strengthen its internal controls and financial reporting. Nauticus plans to transition two current contracted personnel to accounting leadership and controller positions. Nauticus will also add RaaS operations personnel as required when the production Aquanauts are completed, commissioned, and put into service. Nauticus' management will make an assessment of these remediation steps and add additional staff, if necessary to remediate the weakness.

Any failure to develop or maintain effective controls, or any difficulties encountered in their implementation or improvement, could adversely affect Nauticus' operating results or cause it to fail to meet its reporting obligations and may result in a restatement of its financial statements for prior periods. Any failure to implement and maintain effective internal controls also could adversely affect the results of periodic management evaluations and annual independent registered public accounting firm attestation reports regarding the effectiveness of Nauticus' internal control over financial reporting that Nauticus is required to include in its periodic reports that it will file with the SEC under Section 404 of the Sarbanes-Oxley Act. Ineffective disclosure controls and procedures and internal control over financial reporting could also cause investors to lose confidence in Nauticus' reported financial and other information.

In order to maintain and improve the effectiveness of its disclosure controls and procedures and internal control over financial reporting, Nauticus has expended and anticipates that after the closing of the Business Combination will continue to expend significant resources, including accounting-related costs, and provide significant management oversight. Any failure to maintain the adequacy of its internal controls, or consequent inability to produce accurate financial statements on a timely basis, could increase operating costs and could materially and adversely affect Nauticus' ability to operate its business. If Nauticus' internal controls are perceived as inadequate or if Nauticus is perceived to be unable to produce timely or accurate financial statements, investors may lose confidence in its operating results and the stock price of Nauticus' securities following the Business Combination could decline.

Nauticus' independent registered public accounting firm is not required to formally attest to the effectiveness of internal control over financial reporting until after Nauticus is no longer an emerging growth company. At such time, the independent registered public accounting firm may issue a report that is adverse in the event it is not satisfied with the level at which Nauticus' controls are documented, designed or operating. Any failure to maintain effective disclosure controls and internal control over financial reporting could have a material and adverse effect on Nauticus' business, prospects, financial condition and operating results.

Nauticus has yet to achieve positive operating cash flow and, given its projected funding needs, its ability to generate positive cash flow is uncertain.

Nauticus has had negative cash flow from operating activities of \$4.2 million for the three months ended March 31, 2022, and \$5.9 million and \$4.5 million for the years ended December 31, 2021, and 2020, respectively. Nauticus expects to continue to have negative cash flow from operating and investing activities for the remainder of 2022 as it expects to incur research and development, sales and marketing, and general and administrative expenses and make capital expenditures in its efforts to increase sales, engage in development work and ramp up operations. Nauticus' business also will at times require significant amounts of working capital to build inventory and support the growth of additional products. An inability to generate positive cash flow for the near term may adversely affect Nauticus' ability to raise needed capital for its business on reasonable terms, diminish supplier or customer willingness to enter into transactions with Nauticus, and have other adverse effects that may decrease its long-term viability. There can be no assurance that Nauticus will achieve positive cash flow in the near future or at all.

Nauticus' ability to use net operating loss carryforwards and other tax attributes may be limited in connection with the Business Combination or other ownership changes.

Nauticus has incurred losses during its history and does not expect to become profitable in the near future, and may never achieve profitability. To the extent that Nauticus continues to generate taxable losses, unused losses will carry forward to offset future taxable income, if any, until such unused losses expire.

Under the Tax Act, as modified by the CARES Act, U.S. federal net operating loss carryforwards generated in taxable periods beginning after December 31, 2017, may be carried forward indefinitely, but the deductibility of such net operating loss carryforwards in taxable years beginning after December 31, 2020, is limited to 80% of taxable income. It is uncertain if and to what extent various states will conform to the Tax Act or the CARES Act. Suspensions or other restrictions on the use of net operating losses or tax credits, possibly with retroactive effect, may result in Nauticus' existing net operating losses or tax credits expiring or otherwise being unavailable to offset future income tax liabilities.

In addition, the net operating loss carryforwards are subject to review and possible adjustment by the Internal Revenue Service and state tax authorities. Under Sections 382 and 383 of the Internal Revenue Code of 1986, as amended (the "Code"), these federal net operating loss carryforwards and other tax attributes may become subject to an annual limitation in the event of certain cumulative changes in the ownership of Nauticus. An "ownership change" pursuant to Section 382 of the Code generally occurs if one or more stockholders or groups of stockholders who own at least 5% of a company's stock increase their ownership by more than 50 percentage points over their lowest ownership percentage within a rolling three-year period. The ability of Nauticus to utilize net operating loss carryforwards and other tax attributes to offset future taxable income or tax liabilities may be limited as a result of ownership changes, including potential changes in connection with the Business Combination or other transactions. Similar rules may apply under state tax laws. Nauticus has not yet determined the amount of the cumulative change in its ownership resulting from the Business Combination or other transactions, or any resulting limitations on its ability to utilize its net operating loss carryforwards and other tax attributes. If Nauticus earns taxable income, such limitations could result in increased future income tax liability to Nauticus and its future cash flows could be adversely affected. Nauticus has recorded a full valuation allowance related to its net operating loss carryforwards and other deferred tax assets due to the uncertainty of the ultimate realization of the future benefits of those assets.

Nauticus expects to incur substantial R&D costs and devote significant resources to identifying and commercializing new products, which could significantly reduce its profitability and may never result in revenue to Nauticus.

Nauticus' future growth depends on penetrating new markets, adapting existing products to new applications and customer requirements, and introducing new products that achieve market acceptance. Nauticus plans to incur substantial, and potentially increasing, R&D costs as part of its efforts to design, develop, manufacture, and commercialize new products and enhance existing products. Nauticus' R&D expenses were \$1.2 million for the three months ended March 31, 2022, and \$3.5 million and \$5.0 million for the years ended December 31, 2021 and 2020, respectively, and are likely to grow in the future. Because Nauticus accounts for R&D as an operating expense, these expenditures will adversely affect its results of operations in the future. Further, Nauticus' R&D program may not produce successful results, and its new products may not achieve market acceptance, create additional revenue or become profitable.

Nauticus is subject to evolving laws, regulations, standards, policies, and contractual obligations related to data privacy and security laws and regulations, and its actual or perceived failure to comply with such obligations could harm Nauticus' reputation, subject it to significant fines and liability, or otherwise adversely affect its business, prospects, financial condition and operating results.

Nauticus is subject to or affected by a number of federal, state and local laws and regulations, as well as contractual obligations and industry standards, that impose certain obligations and restrictions with respect to data privacy and security, and govern Nauticus' collection, storage, retention, protection, use, processing, transmission, sharing and disclosure of personal information, including that of its employees, customers and others. Most jurisdictions have enacted laws requiring companies to notify individuals, regulatory authorities and others of security breaches involving certain types of data. Such laws may be inconsistent or may change or additional laws may be adopted. In addition, Nauticus' agreements with certain customers may require Nauticus to notify them in the event of a security breach. Such mandatory disclosures are costly, could lead to negative publicity, result in penalties or fines, result in litigation, may cause Nauticus' customers to lose confidence in the effectiveness of Nauticus' security measures and require Nauticus to expend significant capital and other resources to respond to and/or alleviate problems caused by the actual or perceived security breach.

The global data protection landscape is rapidly evolving, and implementation standards and enforcement practices are likely to remain uncertain for the foreseeable future. Nauticus may not be able to monitor and react to all developments in a timely manner. For example, California adopted the California Consumer Privacy Act ("*CCPA*"), which became effective in January 2020. The CCPA establishes a privacy framework for covered businesses, including an expansive definition of personal information and data privacy rights for California residents. The CCPA includes a framework with potentially severe statutory damages and private rights of action. The CCPA requires covered businesses to provide new disclosures to California residents, provide them new ways to opt-out of certain disclosures of personal information, and allow for a new cause of action for data breaches. Additionally, a new privacy law, the California Privacy Rights Act ("*CPRA*"), was approved by California voters in the November 3, 2020 election. The CPRA creates obligations relating to consumer data beginning on January 1, 2022, with implementing regulations expected on or before July 1, 2022, and enforcement beginning July 1, 2023. The CPRA significantly modifies the CCPA, potentially resulting in further uncertainty. Some observers have noted that the CCPA could mark the beginning of a trend toward more stringent privacy legislation in the United States. Other states have begun to propose and enact similar laws. For example, Virginia has enacted the Virginia Consumer Data Protection Act, which provides for obligations similar to the CCPA, and which will go into effect January 1, 2023. As Nauticus expands its operations, the CCPA, CPRA, and other laws and regulations relating to privacy and data security may increase Nauticus' compliance costs and potential liability. Compliance with any applicable privacy and data security laws and regulations is a rigorous and time-intensive process, and Nauticus may be required to put in place additional mechanisms to comply with such laws and regulations.

Additionally, as Nauticus' international presence expands, it may become subject to or face increasing obligations under laws and regulations in countries outside the United States, many of which, such as the European Union's General Data Protection Regulation ("*GDPR*") and national laws supplementing the GDPR, as well as legislation substantially implementing the GDPR in the United Kingdom, are significantly more stringent than those currently enforced in the United States. The GDPR requires companies to meet stringent requirements regarding the handling of personal data of individuals located in the European Economic Area ("*EEA*"). The GDPR also includes significant penalties for noncompliance, which may result in monetary penalties of up to the higher of €20 million or 4% of a group's worldwide turnover for the preceding financial year for the most serious violations. The United Kingdom's version of the GDPR, the UK GDPR, which it maintains along with its Data Protection Act (collectively, the "*UK GDPR*"), also provides for substantial penalties that, for the most serious violations, can go up to the greater of £17.5 million or 4% of a group's worldwide turnover for the preceding financial year. Many other jurisdictions globally are considering or have enacted legislation providing for local storage of data or otherwise imposing privacy, data protection and data security obligations in connection with the collection, use and other processing of personal data.

Nauticus publishes privacy policies and other documentation regarding its collection, processing, use and disclosure of personal information and/or other confidential information. Although Nauticus endeavors to comply with its published policies and other documentation, Nauticus may at times fail to do so or may be perceived to have failed to do so. Moreover, despite its efforts, Nauticus may not be successful in achieving compliance, including if Nauticus' employees, contractors, service providers or vendors fail to comply with its published policies and documentation. Such failures can subject Nauticus to potential action by governmental or regulatory authorities if

[Table of Contents](#)

they are found to be deceptive, unfair, or misrepresentative of its actual practices. Any actual or perceived inability of Nauticus to adequately address privacy and security concerns or comply with applicable laws, rules and regulations relating to privacy, data protection or data security, or applicable privacy notices, could lead to investigations, claims, and proceedings by governmental entities and private parties, damages for contract breach, and other significant costs, penalties, and other liabilities. Any such claims or other proceedings could be expensive and time-consuming to defend and could result in adverse publicity. Any of the foregoing may have an adverse effect on Nauticus' business, prospects, results of operations, and financial condition.

Nauticus is subject to cybersecurity risks to its operational systems, security systems, infrastructure, integrated software in its products and data processed by Nauticus or third-party vendors.

Nauticus' business and operations involve the collection, storage, processing, and transmission of personal data and certain other sensitive and proprietary data of collaborators, customers, and others. Additionally, Nauticus maintains sensitive and proprietary information relating to its business, such as its own proprietary information and personal data relating to its employees. An increasing number of organizations have disclosed breaches of their information security systems and other information security incidents, some of which have involved sophisticated and highly targeted attacks. Nauticus may be a target for attacks by state-sponsored actors and others designed to disrupt its operations or to attempt to gain access to its systems or data that is processed or maintained in its business. The ongoing COVID-19 pandemic has increased security risks due to personnel working remotely.

Nauticus is at risk for interruptions, outages and breaches of its: (a) operational systems, including business, financial, accounting, product development, data processing or production processes, owned by Nauticus or its third-party vendors or suppliers; (b) facility security systems, owned by Nauticus or its third-party vendors or suppliers; (c) transmission control modules or other in-product technology, owned by Nauticus or its third-party vendors or suppliers; (d) the integrated software in Nauticus units; or (e) customer data that Nauticus processes or its third-party vendors or suppliers process on its behalf. Because techniques used to obtain unauthorized access to or to sabotage information systems change frequently and may not be known until launched against a target, Nauticus may be unable to anticipate or prevent these attacks, react in a timely manner, or implement adequate preventive measures, and may face delays in its detection or remediation of, or other responses to, security breaches and other privacy-and security-related incidents. Such incidents could: materially disrupt Nauticus' operational systems; result in loss of intellectual property, trade secrets or other proprietary or competitively sensitive information; compromise certain information of customers, employees, suppliers, or others; jeopardize the security of Nauticus' facilities; or affect the performance of in-product technology and the integrated software in Nauticus' units. Certain efforts may be state-sponsored or supported by significant financial and technological resources, making them even more difficult to detect, remediate, and otherwise respond to.

Nauticus plans to include product services and functionality that utilize data connectivity to monitor performance and timely capture opportunities to enhance performance and for safety and cost-saving preventative maintenance. The availability and effectiveness of Nauticus' services depend on the continued operation of information technology and communications systems. Nauticus' systems will be vulnerable to damage or interruption from, among others, physical theft, fire, terrorist attacks, natural disasters, power loss, war, telecommunications failures, viruses, denial or degradation of service attacks, ransomware, social engineering schemes, insider theft or misuse or other attempts to harm Nauticus' systems. Nauticus intends to use its product services and functionality to log information about each unit's use in order to aid Nauticus in diagnostics and servicing. Nauticus' customers may object to the use of this data, which may require Nauticus to implement new or modified data handling policies and mechanisms, increase Nauticus' unit maintenance costs and costs associated with data processing and handling, and harm its business prospects.

Although Nauticus is in the process of implementing certain systems and processes that are designed to protect its data and systems within its control, prevent data loss, and prevent other security breaches and security incidents, these security measures cannot guarantee security. The IT and infrastructure used in Nauticus' business may be vulnerable to cyberattacks or security breaches, and third parties may be able to access data, including personal data and other sensitive and proprietary data of Nauticus and its customers, collaborators and partners, its employees' personal data, or other sensitive and proprietary data, accessible through those systems. Employee error, malfeasance, or other errors in the storage, use, or transmission of any of these types of data could result in an actual or perceived privacy or security breach or other security incident.

Moreover, there are inherent risks associated with developing, improving, expanding and updating Nauticus' current systems, such as the disruption of Nauticus' data management, procurement, production execution, finance, supply chain and sales and service processes. These risks may affect Nauticus' ability to manage its data and inventory,

procure parts or supplies or manufacture, deploy, deliver and service its units, adequately protect its intellectual property or achieve and maintain compliance with, or realize available benefits under, applicable laws, regulations and contracts. Nauticus cannot be sure that these systems upon which it relies, including those of its third-party vendors or suppliers, will be effectively implemented, maintained or expanded as planned. If Nauticus does not successfully implement, maintain or expand these systems as planned, its operations may be disrupted, its ability to accurately and timely report its financial results could be impaired, and deficiencies may arise in its internal control over financial reporting, which may impact Nauticus' ability to certify its financial results. Moreover, Nauticus' proprietary information or intellectual property could be compromised or misappropriated and its reputation may be adversely affected. If these systems do not operate as Nauticus expects them to, Nauticus may be required to expend significant resources to make corrections or find alternative sources for performing these functions.

Any actual or perceived security breach or security incident, or any systems outages or other disruption to systems used in Nauticus' business, could interrupt Nauticus' operations, result in loss or improper access to, or acquisition or disclosure of, data or a loss of intellectual property protection, harm Nauticus' reputation and competitive position, reduce demand for its products, damage Nauticus' relationships with customers, partners, collaborators, or others, or result in claims, regulatory investigations, and proceedings and significant legal, regulatory, and financial exposure, and any such incidents or any perception that Nauticus' security measures are inadequate could lead to loss of confidence in Nauticus and harm to its reputation, any of which could adversely affect Nauticus' business, financial condition, and results of operations. Any actual or perceived breach of privacy or security, or other security incident, impacting any entities with which Nauticus shares or discloses data (including, for example, its third-party technology providers) could have similar effects. Nauticus expects to incur significant costs in an effort to detect and prevent privacy and security breaches and other privacy- and security-related incidents, and may face increased costs and requirements to expend substantial resources in the event of an actual or perceived privacy or security breach or other incident.

Nauticus is subject to U.S. and foreign anti-corruption and anti-money laundering laws and regulations. Nauticus can face criminal liability and other serious consequences for violations, which can harm its business, prospects, financial condition and operating results.

Nauticus is subject to the U.S. Foreign Corrupt Practices Act of 1977, as amended, the U.S. domestic bribery statute contained in 18 U.S.C. § 201, the U.S. Travel Act, and other anti-corruption, anti-bribery and anti-money laundering laws in countries in which Nauticus conducts activities. Anti-corruption laws are interpreted broadly and prohibit companies and their employees, business partners, third-party intermediaries, representatives, and agents from authorizing, promising, offering or providing, directly or indirectly, improper payments or anything else of value to government officials, political candidates, political parties, or commercial partners for the purpose of obtaining or retaining business or securing an improper business advantage.

Nauticus has direct and indirect interactions with foreign officials, including in furtherance of sales to governmental entities in non-U.S. countries. Nauticus sometimes leverages third parties to conduct its business abroad, and its third-party business partners, representatives, and agents may have direct or indirect interactions with officials and employees of government agencies or state-owned or affiliated entities. Nauticus can be held liable for the corrupt or other illegal activities of its employees or these third-parties, even if Nauticus does not explicitly authorize or have actual knowledge of such activities. The FCPA and other applicable laws and regulations laws also require that Nauticus keep accurate books and records and maintain internal controls and compliance procedures designed to prevent any such actions. While Nauticus has policies and procedures to address compliance with such laws, there can be no assurance that all of Nauticus' employees, business partners, third-party intermediaries, representatives, and agents will not take actions in violation of its policies and applicable law, for which Nauticus may be ultimately held responsible. Nauticus' exposure for violating these laws increases as its international presence expands and as it increases sales and operations in foreign jurisdictions.

Any violations of the laws and regulations described above may result in whistleblower complaints, adverse media coverage, investigations, substantial civil and criminal fines and penalties, damages, settlements, prosecution, enforcement actions, imprisonment, the loss of export or import privileges, suspension or debarment from government contracts, tax reassessments, breach of contract and fraud litigation, reputational harm and other consequences, any of which could adversely affect Nauticus' business, prospects, financial condition and operating results. In addition, responding to any investigation or action will likely result in a significant diversion of management's attention and resources and significant defense costs and other professional fees.

Nauticus is subject to governmental export and import controls and laws that could subject Nauticus to liability if Nauticus is not in compliance with such laws.

Nauticus' products are subject to export control, import and economic sanctions laws and regulations, including the U.S. Export Administration Regulations, U.S. Customs regulations and various economic and trade sanctions regulations administered by the U.S. Treasury Department's Office of Foreign Assets Control. Exports of Nauticus' robotic systems and technology must be made in compliance with these laws and regulations. If Nauticus fails to comply with these laws and regulations, Nauticus and certain of its employees could be subject to substantial civil or criminal penalties, including the possible loss of export or import privileges; fines, which may be imposed on Nauticus and responsible employees or managers; and, in extreme cases, the incarceration of responsible employees or managers.

Moreover, international sales of certain of Nauticus' products are subject to U.S. laws, regulations and policies like the International Traffic in Arms Regulations and other export laws and regulations and may be subject to first obtaining licenses, clearances or authorizations from various regulatory entities. If Nauticus is not allowed to export its products or the clearance process is burdensome and costly, Nauticus' ability to generate revenue would be adversely affected.

In addition, changes to Nauticus' ocean robotic systems, or changes in applicable export control, import, or economic sanctions laws and regulations may create delays in the introduction and sale of Nauticus' robotic systems and solutions or, in some cases, prevent the export or import of Nauticus' robotic systems to certain countries, governments, or persons altogether. Compliance with such laws and regulations may also be costly and require time and attention from Nauticus management. Any change in export, import, or economic sanctions laws and regulations, shift in the enforcement or scope of existing laws and regulations, or change in the countries, governments, persons, or technologies targeted by such laws and regulations, could also result in decreased use of Nauticus' robotic systems, as well as Nauticus' decreased ability to export or market its robotic systems to potential customers. Any decreased use of Nauticus' robotic systems or limitation on Nauticus' ability to export or market its robotic systems would likely adversely affect Nauticus' business, prospects, financial condition and operating results.

Nauticus' management team will have broad discretion in making strategic decisions to execute their growth plans, and there can be no assurance that Nauticus' management's decisions will result in successful achievement of Nauticus' business objectives or will not have unintended consequences that negatively impact Nauticus' growth prospects.

Nauticus' management will have broad discretion in making strategic decisions to execute their growth plans and may devote time and company resources to new or expanded solution offerings, potential acquisitions, prospective customers or other initiatives that do not necessarily improve Nauticus' operating results or contribute to its growth. Management's failure to make strategic decisions that are ultimately accretive to Nauticus' growth may result in unfavorable returns and uncertainty about Nauticus' prospects, each of which could cause the price of the Common Stock to decline.

As part of growing our business, we have and may make acquisitions. If we fail to successfully select, execute, or integrate our acquisitions, then our business, results of operations and financial condition could be materially adversely affected, and our stock price could decline.

Failure to successfully identify, complete, manage and integrate acquisitions could materially and adversely affect our business, financial condition and results of operations and could cause Nauticus' stock price to decline.

From time to time, we may undertake acquisitions to add new products and technologies, acquire talent, gain new sales channels, or enter into new markets or sales territories. In addition to possible stockholder approval, we may need approvals and licenses from relevant government authorities for the acquisitions and to comply with any applicable laws and regulations, and a failure to obtain such approvals and licenses could result in delays and increased costs and may disrupt our business strategy. Furthermore, acquisitions and the subsequent integration of new assets, businesses, key personnel, customers, vendors, and suppliers require significant attention from our management and could result in a diversion of resources from our existing business, which in turn could have an adverse effect on our operations. Acquired assets or businesses may not generate the financial results we expect. Acquisitions could result in the use of substantial amounts of cash, potentially dilutive issuances of equity securities and exposure to potential unknown liabilities of the acquired business. Moreover, the costs of identifying and consummating acquisitions may be significant.

Any acquisitions, partnerships, or joint ventures that we enter into could disrupt our operations and have a material adverse effect on our business, financial condition and results of operations.

From time to time, we may evaluate potential strategic acquisitions of businesses, including partnerships or joint ventures with third parties. We may not be successful in identifying acquisition, partnership, and joint venture candidates. In addition, we may not be able to continue the operational success of such businesses or successfully finance or integrate any businesses that we acquire or with which we form a partnership or joint venture. We may have potential write-offs of acquired assets and/or an impairment of any goodwill recorded as a result of acquisitions. Furthermore, the integration of any acquisition may divert management's time and resources from our core business and disrupt our operations or may result in conflicts with our business. Any acquisition, partnership or joint venture may not be successful, may reduce our cash reserves, may negatively affect our earnings and financial performance and, to the extent financed with the proceeds of debt, may increase our indebtedness. Further, depending on market conditions, investor perceptions of Nauticus and other factors, we might not be able to obtain financing on acceptable terms, or at all, to implement any such transaction. We cannot ensure that any acquisition, partnership, or joint venture we make will not have a material adverse effect on our business, financial condition, and results of operations.

If we are unable to adapt to and satisfy customer demands in a timely and cost-effective manner, our ability to grow our business may suffer.

The success of our business depends in part on effectively engineering and implementing technologies related to subsea and surface vessels, ROVs, subsea robotic manipulators, and AI-based, full-stack vehicle control and manipulation software. These technologies are packaged for commercial and defense customers in products that provide innovative solutions to challenges in all maritime markets including subsea energy, offshore wind, and defense applications. If for any reason we are unable to continue to manufacture, design and develop technologies as planned or provide the services and products that our customers expect from us, this could have a material adverse effect on our business, financial condition, and results of operations. If our current or future product and service offerings do not meet expected performance or quality standards, including with respect to customer satisfaction, this could cause operational delays. In addition, any delay in manufacturing new products as planned could increase costs and cause our products and services to be less attractive to potential new customers. Further, certain government bodies may have priority with respect to the use of our products and services for national defense reasons, which may impact our cadence of producing and selling products and services to other customers. Any production, operational or manufacturing delays or other unplanned changes to our ability to design, develop and manufacture our products or offer our services could have a material adverse effect on our business, financial condition, and results of operations.

If we fail to respond to commercial industry cycles in terms of our cost structure, manufacturing capacity, and/or personnel needs, our business could be seriously harmed.

The timing, length, and severity of the up-and-down cycles in the commercial subsea, ocean surface, and defense industries are difficult to predict. The cyclical nature of the industries in which we operate affects our ability to accurately predict future revenue, and in some cases, future expense levels. During down cycles in our industry, the financial results of our customers may be negatively impacted, which could result not only in a decrease in orders but also a weakening of their financial condition that could impair our ability to recognize revenue or to collect on outstanding receivables. When cyclical fluctuations result in lower-than-expected revenue levels, operating results may be adversely affected, and cost reduction measures may be necessary in order for us to remain competitive and financially sound. We must be in a position to adjust our cost and expense structure to reflect prevailing market conditions and to continue to motivate and retain our key employees. If we fail to respond, then our business could be seriously harmed. In addition, during periods of rapid growth, we must be able to increase engineering and manufacturing capacity and personnel to meet customer demand. We can provide no assurance that these objectives can be met in a timely manner in response to industry cycles. Each of these factors could adversely impact our operating results and financial condition.

Our systems, products, technologies and services and related equipment may have shorter useful lives than we anticipate.

Our growth strategy depends in part on developing systems, products, technologies, and services. These reusable systems, products, technologies and services and systems will have a limited useful life. While we intend to design our products and technologies for a certain lifespan, which corresponds to a number of cycles, there can be no assurance as to the actual operational life of a product or that the operational life of individual components will be consistent with its design life. A number of factors will impact the useful lives of our products and systems, including, among other things, the quality of their design and construction, the durability of their component parts and availability of any replacement components, and the occurrence of any anomaly or series of anomalies or other risks affecting the technology during launch and in orbit. In addition, any improvements in technology may make our existing products, designs, or any component of our products prior to the end of its life obsolete. If our systems, products, technologies and services and related equipment have shorter useful lives than we currently anticipate, this may lead to delays in increasing the rate of our follow on work and new business, which would have a material adverse effect on our business, financial condition, and results of operations. In addition, we are continually learning, and as our engineering and manufacturing expertise and efficiency increases, we aim to leverage this learning to be able to manufacture our products and equipment using less of our currently installed equipment, which could render our existing inventory obsolete.

Risks Related to Government Contracts

Many of our contracts contain performance obligations that require innovative design capabilities, are technologically complex, require state-of-the-art manufacturing expertise, or are dependent upon factors not wholly within our control. Failure to meet these obligations could adversely affect our profitability and future prospects. Early termination of client contracts or contract penalties could adversely affect our results of operations.

We design, develop, and manufacture technologically advanced and innovative products and services, which are applied by our customers in a variety of environments. Problems and delays in development or delivery as a result of issues with respect to design, technology, licensing and intellectual property rights, labor, inability to achieve learning curve assumptions, manufacturing materials or components could prevent us from meeting requirements. Either we or the customer may generally terminate a contract as a result of a material uncured breach by the other. If we breach a contract or fail to perform in accordance with contractual service levels, delivery schedules, performance specifications, or other contractual requirements set forth therein, the other party thereto may terminate such contract for default, and we may be required to refund money previously paid to us by the customer or to pay penalties or other damages. Even if we have not breached, we may deal with various situations from time to time that may result in the amendment or termination of a contract. These steps can result in significant current period charges and/or reductions in current or future revenue, and/or delays in collection of outstanding receivables and costs incurred on the contract. Other factors that may affect revenue and profitability include inaccurate cost estimates, design issues, unforeseen costs and expenses not covered by insurance or indemnification from the customer, diversion of management focus in responding to unforeseen problems, and loss of follow-on work.

We rely on a limited number of suppliers for certain raw materials and supplied components. We may not be able to obtain sufficient raw materials or supplied components to meet our manufacturing, design, and operating needs, or obtain such materials on favorable terms or at all, which could impair our ability to fulfill our orders in a timely manner or increase our costs of design and production.

Our ability to produce our current and future systems, products, technologies and services and other components of operation is dependent upon sufficient availability of raw materials and supplied components, which we secure from a limited number of suppliers. Global supply chains have recently experienced disruption as a result of industry capacity constraints, material availability and global logistics delays arising from transportation capacity of ocean shipping containers and a prolonged delay in resumption of operations by one or more key suppliers as a result of COVID-19. Our reliance on suppliers to secure raw materials and supplied components exposes us to volatility in the prices and availability of these materials. We may not be able to obtain sufficient supplies of raw materials or supplied components on favorable terms or at all, which could result in delays in the manufacture of our systems, products, technologies and services or increased costs.

In addition, we may in the future experience delays in manufacturing or operation as we go through the requalification process with any replacement third-party supplier, as well as the limitations imposed by the International Traffic in Arms Regulations (“ITAR”), the Export Administration Regulations (“EAR”), or other restrictions on transfer of sensitive technologies. Moreover, the imposition of tariffs on such raw materials or supplied components could have a material adverse effect on our operations. Prolonged disruptions in the supply of any of our key raw materials or components, difficulty qualifying new sources of supply, implementing use of replacement materials or new sources of supply or any volatility in prices could have a material adverse effect on our ability to operate in a cost-efficient, timely manner and could cause us to experience cancellations or delays of scheduled missions, customer cancellations or reductions in our prices and margins, any of which could harm our business, financial condition and results of operations.

We use estimates when accounting for certain contracts and changes in these estimates may have a significant impact on our financial results.

Our quarterly and annual sales are affected by a variety of factors that may lead to significant variability in our operating results. We evaluate the contract value and cost estimates for performance obligations at least quarterly, and more frequently when circumstances change significantly. Changes in estimates and assumptions related to the status of certain long-term contracts which could have a material adverse effect on our operating results, financial condition, and/or cash flows.

The U.S. government’s budget deficit and the national debt, as well as any inability of the U.S. government to complete its budget process for any government fiscal year and consequently having to shut down or operate on funding levels equivalent to its prior fiscal year pursuant to a “continuing resolution,” could have an adverse impact on our business, financial condition, results of operations and cash flows.

Considerable uncertainty exists regarding how future budget and program decisions will unfold, including the defense spending priorities of the U.S. government, what challenges budget reductions will present for the defense industry and whether annual appropriations bills for all agencies will be enacted for U.S. government fiscal 2022 and thereafter due to many factors, including but not limited to, changes in the political environment, including before or after a change to the leadership within the government administration, and any resulting uncertainty or changes in policy or priorities and resultant funding. The U.S. government’s budget deficit and the national debt could have an adverse impact on our business, financial condition, results of operations and cash flows in a number of ways, including the following:

- The U.S. government could reduce or delay its spending on, reprioritize its spending away from, or decline to provide funding for the government programs in which we participate;
- U.S. government spending could be impacted by alternate arrangements to sequestration, which increases the uncertainty as to, and the difficulty in predicting, U.S. government spending priorities and levels; and
- We may experience declines in revenue, profitability, and cash flows as a result of reduced or delayed orders or payments or other factors caused by economic difficulties of our customers and prospective customers, including U.S. federal, state, and local governments.

Furthermore, we believe continued budget pressures could have serious negative consequences for the security of the United States, the defense industrial base and the customers, employees, suppliers, investors and communities that rely on companies in the defense industrial base. Budget and program decisions made in this environment would have long-term implications for Nauticus and the entire defense industry.

We depend significantly on U.S. government contracts, which often are only partially funded, subject to immediate termination, and heavily regulated and audited. The termination or failure to fund, or negative audit findings for, one or more of these contracts could have an adverse impact on our business, financial condition, results of operations and cash flows.

Over its lifetime, a U.S. government program may be implemented by the award of many different individual contracts and subcontracts. The funding of U.S. government programs is subject to U.S. Congressional appropriations. In recent years, U.S. government appropriations have been affected by larger U.S. government budgetary issues and

related legislation. Although multi-year contracts may be authorized and appropriated in connection with major procurements, the U.S. Congress generally appropriates funds on a government fiscal year basis. Procurement funds are typically made available for obligation over the course of one to three years. Consequently, programs often initially receive only partial funding, and additional funds are obligated only as the U.S. Congress authorizes further appropriations. We cannot predict the extent to which total funding and/or funding for individual programs will be included, increased, or reduced as part of the annual appropriations process ultimately approved by U.S. Congress and the President of the United States or in separate supplemental appropriations or continuing resolutions, as applicable. The termination of funding for a U.S. government program would result in a loss of anticipated future revenue attributable to that program, which could have an adverse impact on our operations. In addition, the termination of a program or the failure to commit additional funds to a program that already has been started could result in lost revenue and increase our overall costs of doing business.

Generally, U.S. government contracts are subject to oversight audits by U.S. government representatives. Such audits could result in adjustments to our contract costs. Any costs found to be improperly allocated to a specific contract will not be reimbursed, and such costs already reimbursed must be refunded. We have recorded contract revenue based on costs we expect to realize upon final audit. However, we do not know the outcome of any future audits and adjustments, and we may be required to materially reduce our revenue or profits upon completion and final negotiation of audits. Negative audit findings could also result in termination of a contract, forfeiture of profits, suspension of payments, fines or suspension or debarment from U.S. Government contracting or subcontracting for a period of time.

In addition, U.S. government contracts generally contain provisions permitting termination, in whole or in part, without prior notice at the U.S. government's convenience upon payment only for work done and commitments made at the time of termination. For some contracts, we are a subcontractor and not the prime contractor, and in those arrangements, the U.S. Government could terminate the prime contractor for convenience without regard for our performance as a subcontractor. We can give no assurance that one or more of our U.S. government contracts will not be terminated under those circumstances. Also, we can give no assurance that we would be able to procure new contracts to offset the revenue or backlog lost as a result of any termination of our U.S. government contracts. Because a significant portion of our revenue is dependent on our performance and payment under our U.S. government contracts, the loss of one or more large contracts could have a material adverse impact on our business, financial condition, results of operations and cash flows.

Our U.S. government business also is subject to specific procurement regulations and a variety of socioeconomic and other requirements. These requirements, although customary in U.S. government contracts, increase our performance and compliance costs. These costs might increase in the future, thereby reducing our margins, which could have an adverse effect on our business, financial condition, results of operations and cash flows. In addition, the U.S. government has and may continue to implement initiatives focused on efficiencies, affordability and cost growth and other changes to its procurement practices. These initiatives and changes to procurement practices may change the way U.S. government contracts are solicited, negotiated, and managed, which may affect whether and how we pursue opportunities to provide our products and services to the U.S. government, including the terms and conditions under which we do so, which may have an adverse impact on our business, financial condition, results of operations and cash flows. For example, contracts awarded under the Department of Defense's Other Transaction Authority for research and prototypes generally require cost-sharing and may not follow, or may follow only in part, standard U.S. government contracting practices and terms, such as the Federal Acquisition Regulation ("FAR") and Cost Accounting Standards.

Failure to comply with applicable regulations and requirements could lead to fines, penalties, repayments, or compensatory or treble damages, or suspension or debarment from U.S. government contracting or subcontracting for a period of time. Among the causes for debarment are violations of various laws and regulations, including those related to procurement integrity, export control (including ITAR), U.S. government security, employment practices, protection of the environment, accuracy of records, proper recording of costs and foreign corruption. The termination of a U.S. government contract or relationship as a result of any of these acts would have an adverse impact on our operations and could have an adverse effect on our standing and eligibility for future U.S. government contracts.

The terms of certain of our current and likely future contracts are highly sensitive and we are limited in our ability to disclose such terms.

Our success, in large part, depends on our ability to maintain protection over the terms of certain of our current and likely future contracts and agreements, each of which is a highly negotiated agreement with sensitive information that, if publicly disclosed, would be beneficial for our and our partners' competitors to learn and harmful to our and our partners' commercial interests. We are limited in our ability to disclose the terms of these agreements, including terms that may affect our expected cash flows or the value of any collateral, and have taken precautions to protect the disclosure of the sensitive information in such agreements. Therefore, we have not allowed third parties to review the terms of these agreements. If the terms of these agreements were to be disclosed, our ability to compete could be hindered and our relationships with our partners could be damaged, both of which could have a material adverse effect on our business, financial condition, and results of operations. Furthermore, our relationships with our partners could also be damaged, and they may take legal action against us, if they believe that we have disclosed any terms of these agreements without their prior consent.

Disputes with our subcontractors or the inability of our subcontractors to perform, or our key suppliers to timely deliver our components, parts or services, could cause our products, systems or services to be produced or delivered in an untimely or unsatisfactory manner.

We engage subcontractors on many of our contracts. We may have disputes with our subcontractors, including regarding the quality and timeliness of work performed by the subcontractor, customer concerns about the subcontract or subcontractor, our failure to extend existing task orders or issue new task orders under a subcontract, our hiring of the personnel of a subcontractor or vice versa or the subcontractor's failure to comply with applicable law. In addition, there are certain parts, components, and services for many of our products, systems, technologies, and services that we source from other manufacturers or vendors. Some of our suppliers, from time to time, experience financial and operational difficulties, which may impact their ability to supply the materials, components, subsystems, and services that we require. Tariffs recently imposed on certain materials and other trade issues may create or exacerbate existing materials shortages and may result in further supplier business closures. Our supply chain could also be disrupted by external events, such as natural disasters or other significant disruptions (including extreme weather conditions, medical epidemics, acts of terrorism, cyber-attacks and labor disputes), governmental actions and legislative or regulatory changes, including product certification or stewardship requirements, sourcing restrictions, product authenticity and climate change or greenhouse gas emission standards, or availability constraints from increased demand from customers. In addition, the ongoing COVID-19 pandemic has resulted in increased travel restrictions and extended shutdown of certain businesses across the globe. These or any further political or governmental developments or health concerns could result in social, economic, and labor instability. Any inability to develop alternative sources of supply on a cost-effective and timely basis could materially impair our ability to manufacture and deliver products, systems, and services to our customers. We can give no assurances that we will be free from disputes with our subcontractors; material supply constraints or problems; or component, subsystems, or services problems in the future. Also, our subcontractors and other suppliers may not be able to acquire or maintain the quality of the materials, components, subsystems, and services they supply, which may result in greater product returns, service problems and warranty claims and could harm our business, financial condition, results of operations and cash flows. In addition, in connection with our government contracts, we are required to procure certain materials, components and parts from supply sources approved by the U.S. government and we rely on our subcontractors and suppliers to comply with applicable laws, regulations and other requirements regarding procurement of counterfeit, unauthorized or otherwise non-compliant parts or materials, including parts or materials they supply to us, and in some circumstances, we rely on their certifications as to their compliance. From time to time, there are components for which there may be only one supplier, which may be unable to meet our needs. Each of these subcontractor and supplier risks could have a material adverse effect on our business, financial condition, results of operations and cash flows.

We have government customers, which subjects us to risks including early termination, audits, investigations, sanctions and penalties.

We derive a substantial portion of our revenue from contracts with U.S. Department of Defense agencies and may enter into additional contracts with the U.S. or foreign governments in the future. This subjects us to statutes and regulations applicable to companies doing business with the government, including the FAR. These government contracts customarily contain provisions that give the government substantial rights and remedies, many of which are not typically found in commercial contracts and which are unfavorable to contractors. For instance, most U.S. government agencies include provisions that allow the government to unilaterally terminate or modify contracts for convenience, and in that event, the counterparty to the contract may generally recover only its incurred or committed costs and settlement expenses and profit on work completed prior to the termination. If the government terminates a contract for default, the defaulting party may be liable for any extra costs incurred by the government in procuring undelivered items from another source.

Some of our federal government contracts are subject to the approval of appropriations being made by the U.S. Congress to fund the expenditures under these contracts. In addition, government contracts normally contain additional requirements that may increase our costs of doing business, reduce our profits, and expose us to liability for failure to comply with these terms and conditions. These requirements include, for example:

- specialized disclosure and accounting requirements unique to government contracts;
- financial and compliance audits that may result in potential liability for price adjustments, recoupment of government funds after such funds have been spent, civil and criminal penalties, or administrative sanctions such as suspension or debarment from doing business with the U.S. government;
- public disclosures of certain contract and company information; and
- mandatory socioeconomic compliance requirements, including labor requirements, non-discrimination and affirmative action programs and environmental compliance requirements.

Government contracts are also generally subject to greater scrutiny by the government, which can initiate reviews, audits, and investigations regarding our compliance with government contract requirements. In addition, if we fail to comply with government contracting laws, regulations and contract requirements, our contracts may be subject to termination, and we may be subject to financial and/or other liability under our contracts, the Federal Civil False Claims Act (including treble damages and other penalties), or criminal law. In particular, the False Claims Act's "whistleblower" provisions also allow private individuals, including present and former employees, to sue on behalf of the U.S. government. Any penalties, damages, fines, suspension, or damages could adversely affect our ability to operate our business and our financial results.

Our reputation and ability to do business may be impacted by the improper conduct of our employees, agents, or business partners.

We have implemented compliance controls, training, policies and procedures designed to prevent and detect reckless or criminal acts from being committed by our employees, agents or business partners that would violate the laws of the jurisdictions in which we operate, including laws governing payments to government officials, such as the U.S. Foreign Corrupt Practices Act ("FCPA"), the protection of export controlled or classified information, such as ITAR, false claims, procurement integrity, cost accounting and billing, competition, information security and data privacy and the terms of our contracts. This risk of improper conduct may increase as we continue to grow and expand our operations. We cannot ensure, however, that our controls, training, policies and procedures will prevent or detect all such reckless or criminal acts, and we have been adversely impacted by such acts in the past, which have been immaterial in nature. If not prevented, such reckless or criminal acts could subject us to civil or criminal investigations, monetary and non-monetary penalties and suspension and debarment by the U.S. government and could have a material adverse effect on our ability to conduct business, our results of operations and our reputation. In addition, misconduct involving data security lapses resulting in the compromise of personal information or the improper use of our customer's sensitive or classified information could result in remediation costs, regulatory sanctions against us and serious harm to our reputation and could adversely impact our ability to continue to contract with the U.S. government.

Risks Related to CLAQ's Business and the Business Combination

CLAQ's independent registered public accounting firm's report contains an explanatory paragraph that expresses substantial doubt about CLAQ's ability to continue as a "going concern."

As of March 31, 2022, CLAQ had \$296,381 in cash held outside of the Trust Account and a working capital deficit of \$220,239. Further, CLAQ has incurred and expects to continue to incur significant costs in pursuit of its initial business combination. CLAQ cannot assure you that its plans to raise capital or to consummate an initial business combination will be successful. These factors, among others, raise substantial doubt about CLAQ's ability to continue as a going concern. CLAQ's financial statements contained in this proxy statement/prospectus do not include any adjustments relating to the recovery of the recorded assets or the classification of the liabilities that might be necessary should CLAQ be unable to continue as a going concern.

Additional risk factors not presently known to CLAQ or that it currently deems immaterial may also impair CLAQ's business or results of operations. CLAQ may disclose changes to such risk factors or disclose additional risk factors from time to time in CLAQ's future filings with the SEC.

CLAQ will be forced to liquidate the Trust Account if it cannot consummate a business combination by July 19, 2022 (the date that is 12 months from the closing of the IPO), or if extended, January 19, 2023 (the date that is 18 months from the closing of the IPO). In the event of a liquidation, CLAQ's public stockholders will receive \$10.10 per share of Common Stock and the Warrants and Rights will expire worthless.

If CLAQ is unable to complete a business combination by July 19, 2022, or if extended, January 19, 2023, CLAQ will be forced to liquidate, the per-share liquidation distribution will be \$10.10. Warrants and Rights will expire worthless.

In connection with the recent restatement of CLAQ's financial statements, CLAQ's management has concluded that its disclosure controls and procedures were not effective as of December 31, 2021 due to a material weakness in internal control over financial reporting solely related to its accounting for complex financial instruments. If CLAQ is unable to maintain an effective system of disclosure controls and procedures and internal control over financial reporting, it may not be able to accurately report its financial results in a timely manner, which may adversely affect investor confidence in CLAQ and materially and adversely affect its business and financial results.

As previously disclosed in CLAQ's Current Report on Form 8-K filed with the SEC on March 29, 2022, after consultation with its independent registered public accounting firm, CLAQ's management team and its audit committee concluded that it was appropriate to restate its previously issued audited balance sheet as of July 19, 2021 (the "Audited Balance Sheet") included as Exhibit 99.1 to its Current Report on Form 8K filed with the SEC on July 23, 2021 and CLAQ's unaudited and interim financial statements as of and for the three months ended September 30, 2021 contained in CLAQ's Quarterly Report on Form 10-Q filed with the SEC on November 12, 2021 (the "Q3 Form 10-Q"). Accordingly, on March 29, 2022, CLAQ filed Amendment No. 1 to the Q3 Form 10-Q and a restated Audited Balance Sheet, which is included as Exhibit 99.4 to the Annual Report on Form 10-K filed with the SEC on March 29, 2022. As part of such process, CLAQ identified a material weakness in its internal control over financial reporting, solely related to its accounting for complex financial instruments.

A material weakness is a deficiency, or a combination of deficiencies, in internal control over financial reporting such that there is a reasonable possibility that a material misstatement of CLAQ's annual or interim consolidated financial statements will not be prevented or detected and corrected on a timely basis. Effective internal controls are necessary for CLAQ to provide reliable financial reports and prevent fraud. CLAQ expects to take steps to remediate the material weakness, but there is no assurance that any remediation efforts will ultimately have the intended effects.

If CLAQ identifies any new material weaknesses in the future, any such newly identified material weakness could limit its ability to prevent or detect a misstatement of CLAQ's accounts or disclosures that could result in a material misstatement of CLAQ's annual or interim consolidated financial statements. In such case, CLAQ may be unable to maintain compliance with securities law requirements regarding timely filing of periodic reports in addition to applicable stock exchange listing requirements, investors may lose confidence in CLAQ's financial reporting and its stock price may decline as a result. CLAQ cannot assure you that the measures it has taken to date, or any measures it may take in the future, will be sufficient to avoid potential future material weaknesses.

Because the market price of the Combined Company will fluctuate, Nauticus’ stockholders cannot be sure of the value of the Merger Consideration they will receive. In addition, there can be no assurance that any Earnout Shares will be issued.

Release of the Earnout Shares is tied to the volume-weighted average price of the Combined Company Common Stock during a 5-year period following the signing of the Merger Agreement. Accordingly, at the time of providing written consent to the Business Combination, Nauticus stockholders will not know or be able to calculate the market value of the shares of CLAQ Common Stock they would receive as Merger Consideration upon the completion of the Business Combination. Stock price changes may result from a variety of factors, including changes in the business, operations or prospects of Nauticus, regulatory considerations and general business, market, industry or economic conditions. Many of these factors are outside of the control of CLAQ and Nauticus.

The CLAQ Public Stockholders will experience dilution as a consequence of, among other transactions, the issuance of Common Stock as consideration in the Business Combination and the PIPE Investment.

CLAQ’s stockholders will experience immediate dilution as a consequence of the issuance of common stock as consideration in the Business Combination and the PIPE Investment. Having a minority share position may reduce the influence that CLAQ’s current stockholders have on the management of CLAQ.

It is anticipated that upon completion of the Business Combination and assuming no redemptions by CLAQ public stockholders, CLAQ’s public stockholders (other than the PIPE Investors) will retain an ownership interest of approximately 28.5% in the Combined Company the PIPE Investors will own approximately 5.6% of the Combined Company, the Co-Sponsors, officers, directors and other holders of founder shares will retain an ownership interest of approximately 6.8% of the Combined Company, and the Nauticus stockholders will own approximately 59.1% (including the 7,500,000 Earnout Shares) of the Combined Company.

The ownership percentage with respect to the Combined Company does not take into account (i) the redemption of any Public Common Stock by the CLAQ public stockholders or (ii) the issuance of any additional shares upon the closing of the Business Combination under the Incentive Award Plan. If the actual facts are different from these assumptions (which they are likely to be), the percentage ownership retained by the CLAQ stockholders will be different. See “Unaudited Pro Forma Condensed Combined and Consolidated Financial Information.”

The following table shows all possible sources and the extent of dilution, pursuant to the exercise and conversion of Public and Private Warrants, Rights, Nauticus Options, conversion of the Debentures and associated Warrants, that our shareholders who elect not to redeem their shares may experience in connection with the Business Combination, assuming no redemption, intermediate levels of redemption and maximum redemption scenarios:

	No Redemptions ⁽¹⁾		10% Redemption ⁽²⁾		50% Redemption ⁽³⁾		75% Redemption ⁽⁴⁾		Maximum Redemption ⁽⁵⁾	
		%		%		%		%		%
Nauticus										
stockholders ⁽⁶⁾	41,508,647	46.5%	41,508,647	47.4%	41,508,647	51.5%	41,508,647	54.3%	41,508,647	57.6%
CLAQ public										
stockholders ⁽⁷⁾	26,737,500	29.9%	25,012,500	28.5%	18,112,500	22.4%	13,800,000	18.1%	9,487,500	13.2%
Initial										
Stockholders ⁽⁸⁾										
⁽⁹⁾	11,487,500	12.9%	11,487,500	13.1%	11,487,500	14.2%	11,487,500	15.0%	11,487,500	15.9%
PIPE Investment										
investors ⁽¹⁰⁾	9,603,470	10.7%	9,603,470	11.0%	9,603,470	11.9%	9,603,470	12.6%	9,603,470	13.3%
Pro forma fully diluted Common Stock at March 31, 2022	89,337,117	100.0%	87,612,117	100.0%	80,712,117	100.0%	76,399,617	100.0%	72,087,117	100.0%

- (1) Assumes that no CLAQ public stockholders are redeemed.
- (2) Assumes that 1,725,000 Public Common Stock is redeemed for aggregate redemption payments of approximately \$17,424,797, assuming a \$10.10 per share redemption price and based on funds in the Trust Account as of March 31, 2022. The Merger Agreement includes a condition to the closing that at the closing having an amount of available cash from the Trust Account and the PIPE Investment (after giving effect to the redemption of any Public Common Stock in connection with the IPO and the payment of the transaction expenses), of no less than \$50,000,000.
- (3) Assumes that 8,625,000 Public Common Stock is redeemed for aggregate redemption payments of approximately \$87,123,987, assuming a \$10.10 per share redemption price and based on funds in the Trust Account as of March 31, 2022. The Merger Agreement includes a condition to the closing that at the closing having an amount of available cash from the Trust Account and the Equity Financing (as defined in the Merger Agreement) (after giving effect to the redemption of any Public Common Stock in connection with the IPO and the payment of the transaction expenses), of no less than \$50,000,000.
- (4) Assumes that 12,937,500 Public Common Stock is redeemed for aggregate redemption payments of approximately \$130,685,980, assuming a \$10.10 per share redemption price and based on funds in the Trust Account as of March 31, 2022. The Merger Agreement includes a condition to the closing that at the closing having an amount of available cash from the Trust Account and the Equity Financing (as defined in the Merger Agreement) (after giving effect to the redemption of any Public Common Stock in connection with the IPO and the payment of the transaction expenses), of no less than \$50,000,000.

Table of Contents

- (5) *Assumes that 17,250,000 Public Common Stock is redeemed for aggregate redemption payments of approximately \$174,247,973, assuming a \$10.10 per share redemption price and based on funds in the Trust Account as of March 31, 2022. The Merger Agreement includes a condition to the closing that at the closing having an amount of available cash from the Trust Account and the PIPE Investment (after giving effect to the redemption of any Public Common Stock in connection with the IPO and the payment of the transaction expenses), of no less than \$50,000,000.*
- (6) *Includes 7,500,000 shares of Common Stock subject to the Earnout Terms and the exercise of 3,977,368 Nauticus Options. The Earnout Shares subject to the Triggering Events will be deposited into escrow in accordance with the terms of the Merger Agreement and will be subject to reduction or forfeiture in accordance with the terms of the Merger Agreement. However, registered holders will maintain voting rights related to such shares unless forfeited.*
- (7) *Includes 8,625,000 Public Warrants and the issuance of 862,500 shares of Common Stock pursuant to the Rights. Non-redeeming public stockholders could suffer additional dilution in their ownership and voting interest of the combined company upon exercise of the Public Warrants held by redeeming CLAQ public stockholder who continue to hold these warrants, which could have an aggregate value of \$3,967,500, based on the closing trading price per Public Warrant as of May 16, 2022.*
- (8) *Includes 4,312,500 outstanding founder shares and 7,175,000 Private Warrants.*
- (9) *Total of 4,312,500 outstanding founder shares includes 1,437,500 founder shares held by the Sponsor, 2,595,000 founder shares held by CleanTech Investments, and 280,000 founder shares held by the officers and directors of CleanTech. Please see the section titled "Beneficial Ownership of Securities."*
- (10) *Assumes the sale of an aggregate of 3,530,000 shares of CleanTech Common Stock, for a purchase price of \$10.00 per share and an aggregate purchase price of \$35,300,000, conversion of the Debentures at a conversion price of \$15.00 and exercise and conversion of the Warrants into Common Stock.*

You must tender your Common Stock in order to validly seek redemption at the Meeting of stockholders.

In connection with tendering your Common Stock for redemption, you must elect either to physically tender your share certificates to Continental or to deliver your Common Stock to Continental electronically using DTC's DWAC (Deposit/Withdrawal At Custodian) System, in each case at least two business days before the Meeting. The requirement for physical or electronic delivery ensures that a redeeming holder's election to redeem is irrevocable once the Business Combination is consummated. Any failure to observe these procedures will result in your loss of redemption rights in connection with the vote on the Business Combination.

If third parties bring claims against CLAQ, the proceeds held in trust could be reduced and the per share liquidation price received by CLAQ's public stockholders may be less than \$10.10.

CLAQ's placing of funds in trust may not protect those funds from third party claims against CLAQ. Although CLAQ has received from many of the vendors, service providers (other than its independent accountants) and prospective target businesses with which it does business executed agreements waiving any right, title, interest or claim of any kind in or to any monies held in the Trust Account for the benefit of CLAQ's public stockholders, they may still seek recourse against the Trust Account. Additionally, a court may not uphold the validity of such agreements. Accordingly, the proceeds held in trust could be subject to claims which could take priority over those of CLAQ's public stockholders. If CLAQ liquidates the Trust Account before the completion of a business combination and distributes the proceeds held therein to its public stockholders, the Co-Sponsors have contractually agreed that they will be liable to ensure that the proceeds in the Trust Account are not reduced by the claims of target businesses or claims of vendors or other entities that are owed money by us for services rendered or contracted for or products sold to us, but only if such a vendor or prospective target business does not execute such a waiver. However, CLAQ cannot assure you that they will be able to meet such obligation. Therefore, the per-share distribution from the Trust Account for our public stockholders may be less than \$10.10 per share due to such claims.

Additionally, if CLAQ is forced to file a bankruptcy case or an involuntary bankruptcy case is filed against it which is not dismissed, the proceeds held in the Trust Account could be subject to applicable bankruptcy law, and may be included in CLAQ's bankruptcy estate and subject to the claims of third parties with priority over the claims of its stockholders. To the extent any bankruptcy claims deplete the Trust Account, CLAQ may not be able to return \$10.10 to our public stockholders.

Any distributions received by CLAQ stockholders could be viewed as an unlawful payment if it was proved that immediately following the date on which the distribution was made, CLAQ was unable to pay its debts as they fell due in the ordinary course of business.

CLAQ's Certificate of Incorporation provides that it will continue in existence only until the date that is 12 months from the closing of the IPO, or July 19, 2022, unless the time period to consummate an initial business combination has been extended to 18 months from the closing of the IPO, or January 19, 2023. If CLAQ is unable to consummate a transaction within the required time periods, upon notice from CLAQ, the trustee of the Trust Account will distribute the amount in its Trust Account to its public stockholders. Concurrently, CLAQ shall pay, or reserve for payment, from funds not held in trust, its liabilities and obligations, although CLAQ cannot assure you that there will be sufficient funds for such purpose.

We expect that all costs and expenses associated with implementing our plan of dissolution, as well as payments to any creditors, will be funded from amounts remaining out of the approximately \$1,500,000 of proceeds held outside the trust account, although we cannot assure you that there will be sufficient funds for such purpose. We will depend on sufficient interest being earned on the proceeds held in the Trust Account to pay any tax obligations we may owe or for working capital purposes.

However, we may not properly assess all claims that may be potentially brought against us. As such, our stockholders could potentially be liable for any claims to the extent of distributions received by them (but no more) and any liability of our stockholders may extend well beyond the third anniversary of the date of distribution. Accordingly, third parties may seek to recover from our stockholders amounts owed to them by us.

If, after we distribute the proceeds in the Trust Account to our public stockholders, we file a bankruptcy petition or an involuntary bankruptcy petition is filed against us that is not dismissed, any distributions received by stockholders could be viewed under applicable debtor/creditor and/or bankruptcy laws as either a "preferential transfer" or a "fraudulent conveyance." As a result, a bankruptcy court could seek to recover all amounts received by our stockholders. In addition, our Board may be viewed as having breached its fiduciary duty to our creditors and/or having acted in bad faith, thereby exposing itself and us to claims of punitive damages, by paying public stockholders from the trust account prior to addressing the claims of creditors.

If CLAQ's due diligence investigation of Nauticus was inadequate, then stockholders of CLAQ following the Business Combination could lose some or all of their investment.

Even though CLAQ conducted a due diligence investigation of Nauticus, it cannot be sure that this diligence uncovered all material issues that may be present inside Nauticus or its business, or that it would be possible to uncover all material issues through a customary amount of due diligence, or that factors outside of Nauticus and its business and outside of its control will not later arise. At the time when the CLAQ Board approved the Business Combination in December 2021, the CLAQ Board considered that they were not obtaining an opinion from any independent investment banking or valuation firm that the consideration to be received by Nauticus is fair to CLAQ or its shareholders from a financial point of view.

Duff & Phelps' opinion obtained by the CLAQ Board addresses only the fairness of the consideration of be paid by CLAQ to Nauticus security holders in the Business Combination, but there is no separate opinion rendered on the fairness of the Business Transaction to the public shareholders or shareholders unaffiliated with the Sponsors or their affiliates.

On January 28, 2022, in order to provide added transparency to the transactions contemplated by the Merger Agreement and greater certainty to close the Business Transaction in the current turbulent market, CLAQ retained Duff & Phelps to serve as an independent financial advisor to the Board of CLAQ, specifically to provide to the Board a fairness opinion in connection with the Business Combination. On March 24, 2022, the CLAQ Board (solely in their capacity as members of the CLAQ Board) obtained an opinion from Duff & Phelps that the consideration to be paid by CLAQ to the Nauticus securityholders in the Business Combination pursuant to the Merger Agreement is fair to CLAQ, from a financial point of view. However, there was no separate opinion rendered on the fairness of the Business Combination to the public shareholders or shareholders unaffiliated with the Co-Sponsors or their affiliates.

Stockholder litigation and regulatory inquiries and investigations are expensive and could harm CLAQ's business, financial condition and operating results and could divert management attention.

In the past, securities class action litigation and/or stockholder derivative litigation and inquiries or investigations by regulatory authorities have often followed certain significant business transactions, such as the sale of a company or announcement of any other strategic transaction, such as the Business Combination. Any stockholder litigation and/or regulatory investigations against CLAQ, whether or not resolved in CLAQ's favor, could result in substantial costs and divert CLAQ's management's attention from other business concerns, which could adversely affect CLAQ's business and cash resources and the ultimate value CLAQ's stockholders receive as a result of the Business Combination.

The Initial Stockholders who own shares of common stock and Private Warrants will not participate in liquidation distributions and, therefore, they may have a conflict of interest in determining whether the Business Combination is appropriate.

As of the Record Date, the Initial Stockholders owned an aggregate of 4,125,000 shares of common stock and 7,175,000 Private Warrants. They have waived their right to redeem any Common Stock in connection with a stockholder vote to approve a proposed initial business combination or sell any Common Stock to CLAQ in a tender offer in connection with a proposed initial business combination, or to receive distributions with respect to any Common Stock upon the liquidation of the Trust Account if CLAQ is unable to consummate a business combination. Based on a market price of \$10.03 per share of Common Stock on May 20, 2022, the total value of the Common Stock held by the Initial Stockholders was approximately \$43.3 million. Based on a market price of \$0.42 per Public Warrant on May 20, 2022, the total value of the Private Warrants held by the Initial Stockholders was approximately \$3.0 million. The Private Warrants (including underlying securities) and founder shares acquired prior to the IPO will be worthless if CLAQ does not consummate a business combination. Consequently, our directors' discretion in identifying and selecting Nauticus as a suitable target business may result in a conflict of interest when determining whether the terms, conditions and timing of the Business Combination are appropriate and in CLAQ's public stockholders' best interest.

CLAQ is requiring stockholders who wish to redeem their Common Stock in connection with a proposed business combination to comply with specific requirements for redemption that may make it more difficult for them to exercise their redemption rights prior to the deadline for exercising their rights.

CLAQ is requiring stockholders who wish to redeem their Common Stock to either tender their certificates to Continental or to deliver their Common Stock to Continental electronically using the DTC's DWAC (Deposit/Withdrawal At Custodian) System at least two business days before the Meeting. In order to obtain a physical certificate, a stockholder's broker and/or clearing broker, DTC and Continental will need to act to facilitate this request. It is CLAQ's understanding that stockholders should generally allot at least two weeks to obtain physical certificates from Continental. However, because we do not have any control over this process or over the brokers or DTC, it may take significantly longer than two weeks to obtain a physical certificate. While we have been advised that it takes a short time to deliver Common Stock through the DWAC System, we cannot assure you of this fact. Accordingly, if it takes longer than CLAQ anticipates for stockholders to deliver their Common Stock, stockholders who wish to redeem may be unable to meet the deadline for exercising their redemption rights and thus may be unable to redeem their Common Stock. Based on a market price of \$0.56 per Public Warrant on May 16, 2022, the total value of the Public Warrants that may be retained by redeeming stockholders assuming maximum redemptions was approximately \$3.45 million.

CLAQ will require its public stockholders who wish to redeem their Common Stock in connection with the Business Combination to comply with specific requirements for redemption described above, such redeeming stockholders may be unable to sell their securities when they wish to in the event that the Business Combination is not consummated.

If CLAQ requires public stockholders who wish to redeem their Common Stock in connection with the proposed Business Combination to comply with specific requirements for redemption as described above and the Business Combination is not consummated, CLAQ will promptly return such certificates to its public stockholders. Accordingly, investors who attempted to redeem their Common Stock in such a circumstance will be unable to sell their securities after the failed acquisition until CLAQ has returned their securities to them. The market price of Common Stock may decline during this time and you may not be able to sell your securities when you wish to, even while other stockholders that did not seek redemption may be able to sell their securities.

Even if we consummate the Business Combination, the Public Warrants may never be in the money, and they may expire worthless.

The exercise price for Public Warrants is \$11.50 per share. There can be no assurance that the Public Warrants will be in the money prior to their expiration and, as such, the warrants may expire worthless. The terms of Public Warrants may be amended in a manner that may be adverse to the holders. The warrant agreement between Continental Stock Transfer & Trust Company, as warrant agent, and us, dated July 14, 2021 (the “Warrant Agreement”) provides that the terms of the warrants may be amended without the consent of any holder to cure any ambiguity or correct any defective provision, but requires the approval by the holders of a majority of the then-outstanding Public Warrants to make any change that adversely affects the interests of the registered holders. Accordingly, we may amend the terms of the warrants in a manner adverse to a holder if holders of at least a majority of the then-outstanding Public Warrants approve of such amendment. Our ability to amend the terms of the warrants with the consent of a majority of the then-outstanding Public Warrants is unlimited. Examples of such amendments could be amendments to, among other things, increase the exercise price of the warrants, shorten the exercise period or decrease the number of CLAQ Common Stock purchasable upon exercise of a warrant.

We may redeem your unexpired warrants prior to their exercise at a time that is disadvantageous to you, thereby making your Public Warrants worthless.

We have the ability to redeem outstanding Public Warrants at any time after they become exercisable and prior to their expiration, at \$0.01 per warrant, provided that the last reported sales price (or the closing bid price of our common stock in the event the shares of our common stock are not traded on any specific trading day) of the common stock equals or exceeds \$16.50 per share (as adjusted for stock splits, stock dividends, reorganizations and the like) on each of 20 trading days within the 30 trading-day period ending on the third business day prior to the date on which we send proper notice of such redemption, provided that on the date we give notice of redemption and during the entire period thereafter until the time we redeem the warrants, we have an effective registration statement under the Securities Act covering Common Stock issuable upon exercise of the warrants and a current prospectus relating to them is available. If and when the Public Warrants become redeemable by us, we may exercise our redemption right even if we are unable to register or qualify the underlying securities for sale under all applicable state securities laws. Redemption of the outstanding Public Warrants could force a warrant holder: (i) to exercise its warrants and pay the exercise price therefor at a time when it may be disadvantageous for it to do so, (ii) to sell its warrants at the then-current market price when it might otherwise wish to hold its Public Warrants or (iii) to accept the nominal redemption price which, at the time the outstanding Public Warrants are called for redemption, will be substantially less than the market value of its Public Warrants.

If CLAQ’s security holders exercise their registration rights with respect to their securities, it may have an adverse effect on the market price of CLAQ’s securities.

CLAQ’s Initial Stockholders are entitled to make a demand that it register the resale of their founder shares at any time commencing three months prior to the date on which their shares may be released from escrow. Additionally, the holders of the Private Warrants and any Units the Initial Stockholders, officers, directors, or their affiliates may be issued in payment of working capital loans made to CLAQ, are entitled to demand that CLAQ register the resale of the Private Warrants and any other Units CLAQ issues to them (and the underlying securities) commencing at any time after CLAQ consummates an initial business combination. If such persons exercise their registration rights with respect to all of their securities, then there will be an additional 4,312,500 shares of common stock and 7,175,000 Private Warrants (and underlying securities) eligible for trading in the public market. The presence of these additional shares of common stock and Units (and underlying securities) trading in the public market may have an adverse effect on the market price of CLAQ’s securities.

If the Business Combination’s benefits do not meet the expectations of financial or industry analysts, the market price of CLAQ’s securities may decline. A market for our securities may not continue, which would adversely affect the liquidity and price of our securities.

The market price of CLAQ’s securities may decline as a result of the Business Combination if:

- CLAQ does not achieve the perceived benefits of the acquisition as rapidly as, or to the extent anticipated by, financial or industry analysts; or
- The effect of the Business Combination on the financial statements is not consistent with the expectations of financial or industry analysts.

[Table of Contents](#)

Following the Business Combination, the price of CLAQ's securities may fluctuate significantly due to the market's reaction to the Business Combination and general market and economic conditions. An active trading market for CLAQ securities following the Business Combination may never develop or, if developed, it may not be sustained. In addition, following the Business Combination, fluctuations in the price of the Combined Company's securities could contribute to the loss of all or part of your investment. Prior to the Business Combination, there has not been a public market for Nauticus' capital stock. Accordingly, the valuation ascribed to Nauticus may not be indicative of the price that will prevail in the trading market following the Business Combination. If an active market for Nauticus' securities develops and continues, the trading price of the Combined Company's securities following the Business Combination could be volatile and subject to wide fluctuations in response to various factors, some of which are beyond our control. Any of the factors listed below could have a material adverse effect on your investment in the Combined Company's securities and Combined Company's securities may trade at prices significantly below the price you paid for them. In such circumstances, the trading price of Combined Company's securities may not recover and may experience a further decline.

Factors affecting the trading price of the Combined Company's securities may include:

- actual or anticipated fluctuations in the Combined Company's quarterly financial results or the quarterly financial results of companies perceived to be similar to it;
- changes in the market's expectations about the Combined Company's operating results;
- the Combined Company's operating results failing to meet the expectation of securities analysts or investors in a particular period;
- changes in financial estimates and recommendations by securities analysts concerning the Combined Company's in general;
- failure to meet or exceed the financial projections of the Combined Company;
- commencement of, or involvement in, litigation involving the Combined Company, including litigation relating to the Business Combination, which may be more likely as a result of the earnout provisions in the Merger Agreement;
- changes in the Combined Company's capital structure, such as future issuances of securities or the incurrence of additional debt; and
- operating and share price performance of other companies that investors deem comparable to the Combined Company.

CLAQ's directors and officers have certain conflicts in determining to recommend the acquisition of Nauticus, since certain of their interests, and certain interests of their affiliates and associates, are different from, or in addition to, your interests as a shareholder.

CLAQ's management and directors have interests in and arising from the Business Combination that are different from, or in addition to, your interests as a shareholder, which could result in a real or perceived conflict of interest. These interests include the fact that certain of the shares of common stock and Private Warrants (including the underlying securities) owned by CLAQ's Co-Sponsors, management and directors, or their affiliates and associates, would become worthless if the Business Combination Proposal is not approved and CLAQ otherwise fails to consummate a business combination prior to July 19, 2022 (unless such date has been extended as described herein). When you consider the recommendation of the Board in favor of adoption of the Business Combination Proposal and other Proposals, you should keep in mind that CLAQ's directors and officers and their affiliates have interests in the Business Combination that are different from, or in addition to, your interests as a shareholder, including:

- CLAQ's Co-sponsors have a fiduciary obligation to each of their respective members and Eli Spiro, (CLAQ's Chief Executive Officer and Director) and Jonas Grossman (a CLAQ Director) are the controlling members of our Co-sponsors. Because each of Mr. Spiro and Mr. Grossman have a fiduciary obligation to both CLAQ and the Co-sponsors, they had a conflict of interest when voting on the Business Combination.

- If an initial business combination, such as the Business Combination, is not completed, CLAQ will be required to dissolve and liquidate. In such event, the 4,312,500 founder shares currently held by the Initial Stockholders, which were acquired prior to the IPO will be worthless because such holders have agreed to waive their rights to any liquidation distributions. The founder shares were purchased for an aggregate purchase price of \$25,000, and had an aggregate market value of approximately \$43.3 million based on the closing price of \$10.03 per share of CLAQ common stock on the Nasdaq Stock Market as of May 20, 2022.
- If an initial business combination, such as the Business Combination, is not completed, an aggregate of 7,175,000 Private Warrants purchased by CLAQ's Co-sponsors for a total purchase price of \$7,175,000, will be worthless. The Private Warrants had an aggregate market value of approximately \$3.0 million based on the closing price of \$0.42 per Public Warrant on the Nasdaq Stock Market as of May 20, 2022.
- Because of these interests, CLAQ's Initial Stockholders could benefit from the completion of a business combination that is not favorable to its public shareholders and may be incentivized to complete an acquisition of a less favorable target company or on terms less favorable to public shareholders rather than liquidate. For example, if the share price of the CLAQ common stock declined to \$5.00 per share after the close of the business combination, CLAQ's public shareholder that purchased shares in the initial public offering, would have a loss of \$5.00 per share, while CLAQ's Sponsor would have a gain of \$4.99 per share because it acquired the founder shares for a nominal amount. In other words, CLAQ's Initial Stockholders can earn a positive rate of return on their investment even if public shareholders experience a negative rate of return in the post-combination company.
- One of CLAQ's Co-sponsors is CleanTech Sponsor, and the managing member of CleanTech Sponsor is Eli Spiro, CLAQ's Chief Executive Officer and Director. If an initial business combination, such as the Business Combination, is not completed, CleanTech Sponsor will lose an aggregate of approximately \$28.3 million, comprised of the following:
 - approximately \$26.0 million (based on the closing price of \$10.03 per share of CLAQ common stock on the Nasdaq Stock Market as of May 20, 2022) of the 2,595,000 founder shares CleanTech Sponsor holds;
 - approximately \$2.0 million (based on the closing price of \$0.42 per Public Warrant on the Nasdaq Stock Market as of May 20, 2022) of the 4,783,333 Private Warrants CleanTech Sponsor holds; and
 - repayment of an interest-free loan of \$267,000 by CleanTech Sponsor since the loan will become payable only after Closing of the Business Combination, or the date on which CLAQ determines that it is unable to effect a business combination.
- CLAQ's other Co-sponsor, CleanTech Investments, is an affiliate of Chardan, and CLAQ's director, Mr. Jonas Grossman, is the Managing Partner and President of Chardan. If an initial business combination, such as the Business Combination, is not completed, Chardan will lose an aggregate of approximately \$23.8 million, comprised of the following:
 - approximately \$14.4 million (based on the closing price of \$10.03 per share of CLAQ common stock on the Nasdaq Stock Market as of May 20, 2022) of the 1,437,500 founder shares CleanTech Investment holds;
 - approximately \$1.0 million (based on the closing price of \$0.42 per Public Warrant on the Nasdaq Stock Market as of May 20, 2022) of the 2,391,667 Private Warrants CleanTech Investment holds;
 - a marketing fee of \$6,037,500 for certain services pursuant to a Business Combination Marketing Agreement;
 - a placement fee of \$2,118,000 (i.e., 6.0% of the PIPE Investment that is not sold to an affiliate of Chardan) for certain services pursuant to the Financial Advisory Agreement (pursuant to the Financial Advisory Agreement, Chardan also has a right of first refusal to act as a book-running manager with minimum economics of 15% for the first two public or private equity offerings by CLAQ or any successor or subsidiary of CLAQ);

- repayment of an interest-free loan of \$133,000 by CleanTech Investments since the loan will become payable only after Closing of the Business Combination, or the date on which CLAQ determines that it is unable to effect a business combination; and
- the \$10,000 monthly administrative fee under the Administrative Support Agreement pursuant to which CLAQ may delay payment of the same until the consummation of a business combination. As of March 2022, there is an accrued and unpaid balance of \$83,333 owed to Chardan under the Administrative Support Agreement.
- If an initial business combination, such as the Business Combination, is not completed, the Initial Stockholders will lose a combined aggregate amount of approximately \$46.7 million (including the Co-sponsors' loans and securities held based on the closing price of \$10.03 per share of CLAQ common stock and \$0.42 per Public Warrant on May 20, 2022), and the Initial Stockholders together with their affiliates (including Chardan) will lose a combined aggregate amount of approximately \$54.9 million (including Chardan's fees contingent upon the Closing of the Business Combination.)
- If the proposed Business Combination is not completed, CLAQ's Initial Stockholders will not have the potential ownership interest of approximately 6.8% (assuming no redemption) or 8.6% (assuming maximum redemption) in the combined company, assuming exercise and conversion of all securities.
- As of the date of this proxy statement/prospectus, ATW is the only purchaser for the Debentures and associated Warrants in the Debt Financing. ATW is managed by ATW Partners Opportunities Management, LLC, which is an affiliate of Chardan, and our director, Mr. Jonas Grossman, is the Managing Partner and President of Chardan.
- The exercise of CLAQ's directors' and officers' discretion in agreeing to changes or waivers in the terms of the transaction may result in a conflict of interest when determining whether such changes or waivers are appropriate and in our stockholders' best interest.
- If the Business Combination is completed, Nauticus will designate all members of the Combined Company's Board of Directors, except for the Transocean Designee).

See "Proposal 1 — The Business Combination Proposal — Interests of Certain Persons in the Business Combination" beginning on page 124 for additional information.

CLAQ and Nauticus have incurred and expect to incur significant costs associated with the Business Combination. Whether or not the Business Combination is completed, the incurrence of these costs will reduce the amount of cash available to be used for other corporate purposes by the Combined Company if the Business Combination is completed or by CLAQ if the Business Combination is not completed.

CLAQ and Nauticus expect to incur significant costs associated with the Business Combination. Whether or not the Business Combination is completed, CLAQ expects to incur approximately \$1,400,000 in expenses for legal and accounting services (including an anticipated amount of \$100,000 of accrued and unpaid administrative fees owed to Chardan under the Administrative Support Agreement). These expenses will reduce the amount of cash available to be used for other corporate purposes by the Combined Company if the Business Combination is completed or by CLAQ if the Business Combination is not completed. Of the estimated transaction costs, \$0.3 million has already been incurred and reflected in the historical financial statements of CLAQ. If the Business Combination is completed, CLAQ estimates the transaction costs for CLAQ to consist of (i) \$6.0 million pursuant to a Business Combination Marketing Agreement with Chardan, (ii) \$1.0 million in legal costs; (iii) \$0.7 million pursuant to letter agreements with Roth and Lake Street, and (iv) approximately \$0.6 million of miscellaneous and estimated printing and accounting services; and for Nauticus to consist of (a) \$7.6 million pursuant to an amended and restated financial advisory agreement with Coastal, (b) \$2.1 million pursuant to a Financial Advisory Agreement with Chardan, representing 6.0% of the gross proceeds received from the PIPE Investment, (c) \$2.0 million in legal costs, and (d) \$1.8 million pursuant to a letter agreement dated March 23, 2022 with Cowen, in which Nauticus has agreed to pay Cowen an advisory fee upon closing of the Business Combination.

CLAQ will incur significant transaction costs in connection with transactions contemplated by the Merger Agreement.

CLAQ will incur significant transaction costs in connection with the Business Combination. If the Business Combination is not consummated, CLAQ may not have sufficient funds to seek an alternative business combination and may be forced to liquidate and dissolve.

The unaudited pro forma condensed combined and consolidated financial information included in this proxy statement/prospectus may not be indicative of what the Combined Company's actual financial position or results of operations would have been.

The unaudited pro forma condensed combined and consolidated financial information in this proxy statement/prospectus is presented for illustrative purposes only and is not necessarily indicative of what Combined Company's actual financial position or results of operations would have been had the Business Combination been completed on the dates indicated. See the section titled "Unaudited Pro Forma Condensed Combined and Consolidated Financial Information" for more information.

In the event that a significant number of Common Stock are redeemed, our Common stock may become less liquid following the Business Combination.

If a significant number of Common Stock are redeemed, CLAQ may be left with a significantly smaller number of stockholders. As a result, trading in the shares of the Combined Company may be limited and your ability to sell your shares in the market could be adversely affected. The Combined Company intends to apply to list its shares on the Nasdaq Stock Market ("Nasdaq"), and Nasdaq may not list the common stock on its exchange, which could limit investors' ability to make transactions in CLAQ's securities and subject CLAQ to additional trading restrictions.

The Combined Company will be required to meet the initial listing requirements to be listed on the Nasdaq Stock Market. However, the Combined Company may be unable to maintain the listing of its securities in the future.

If the Combined Company fails to meet the continued listing requirements and Nasdaq delists its securities, CLAQ could face significant material adverse consequences, including:

- a limited availability of market quotations for its securities;
- a limited amount of news and analyst coverage for the Combined Company; and
- a decreased ability to issue additional securities or obtain additional financing in the future.

CLAQ may waive one or more of the conditions to the Business Combination without resoliciting shareholder approval for the Business Combination.

CLAQ may agree to waive, in whole or in part, some of the conditions to its obligations to complete the Business Combination, to the extent permitted by applicable laws. The Board will evaluate the materiality of any waiver to determine whether amendment of this proxy statement/prospectus and resolicitation of proxies is warranted. In some instances, if the Board determines that a waiver is not sufficiently material to warrant resolicitation of stockholders, CLAQ has the discretion to complete the Business Combination without seeking further shareholder approval. For example, it is a condition to CLAQ's obligations to close the Business Combination that there be no applicable law and no injunction or other order restraining or imposing any condition on the consummation of the Business Combination, however, if the Board determines that any such order or injunction is not material to the business of Nauticus, then the Board may elect to waive that condition without shareholder approval and close the Business Combination.

CLAQ's stockholders will experience immediate dilution as a consequence of the issuance of common stock as consideration in the Business Combination (including the Earnout Shares), PIPE Investment and the Nauticus Convertible Notes Conversion. Having a minority share position may reduce the influence that CLAQ's current stockholders have on the management of CLAQ.

It is anticipated that upon completion of the Business Combination and assuming no redemptions by CLAQ public stockholders, CLAQ's public stockholders (other than the PIPE Investment investors) will retain an ownership interest of approximately 28.5% in the Combined Company, the PIPE Investment investors will own approximately

[Table of Contents](#)

5.6% of the Combined Company, the Co-Sponsors, officers, directors and other holders of founder shares will retain an ownership interest of approximately 6.8% of the Combined Company, and the Nauticus stockholders will own approximately 59.1% (including the 7,500,000 Earnout Shares) of the Combined Company. As a result of the Merger, an aggregate of 4,850,999 shares of CLAQ Common Stock will be issued to the holders of Nauticus Convertible Notes.

The ownership percentage with respect to the Combined Company does not take into account (i) the redemption of any Public Common Stock by the CLAQ public stockholders or (ii) the issuance of any additional shares upon the closing of the Business Combination under the Incentive Award Plan. If the actual facts are different from these assumptions (which they are likely to be), the percentage ownership retained by the CLAQ stockholders will be different. See “*Unaudited Pro Forma Condensed Combined and Consolidated Financial Information.*”

Changes in applicable laws or regulations, or a failure to comply with any applicable laws and regulations, may adversely affect CLAQ’s business, including its ability to negotiate and complete its initial business combination and results of operations.

CLAQ is subject to the federal securities laws, the SEC rules and regulations and other legal requirements. Compliance with, and monitoring of, applicable laws and regulations may be difficult, time consuming and costly.

Those laws and regulations and their interpretation and application may also change from time to time and those changes could have a material adverse effect on CLAQ’s business, investments and results of operations. In addition, a failure to comply with applicable laws or regulations, as interpreted and applied, could have a material adverse effect on CLAQ’s business, including its ability to negotiate and complete its initial business combination and results of operations.

On March 30, 2022, the SEC issued proposed rules relating to, among other items, enhancing disclosures in business combination transactions involving special purpose acquisition companies (“SPACs”) such as CLAQ, amending the scope of a safe harbor for financial projections, and increasing the potential liability of certain participants in proposed business combination transactions. These proposed rules, if adopted, whether in the form proposed or in revised form, may materially adversely affect CLAQ’s ability to negotiate and complete its initial business combination and may increase the costs and time related thereto.

Risks Related to Combined Company’s Common Stock

Because the Combined Company will become a public reporting company by means other than a traditional underwritten initial public offering, the Combined Company’s stockholders may face additional risks and uncertainties.

Because the Combined Company will become a public reporting company by means of consummating the Business Combination rather than by means of a traditional underwritten initial public offering, there is no independent third-party underwriter selling the shares of the Combined Company’s common stock, and, accordingly, the Combined Company’s stockholders will not have the benefit of an independent review and investigation of the type normally performed by an unaffiliated, independent underwriter in a public securities offering. Due diligence reviews typically include an independent investigation of the background of the company, any advisors and their respective affiliates, review of the offering documents and independent analysis of the plan of business and any underlying financial assumptions. Because there is no independent third-party underwriter selling the shares of the Combined Company’s common stock, you must rely on the information included in this proxy statement/prospectus. Although CLAQ performed a due diligence review and investigation of Nauticus in connection with the Business Combination, the lack of an independent due diligence review and investigation increases the risk of investment in the Combined Company because it may not have uncovered facts that would be important to a potential investor.

In addition, because the Combined Company will not become a public reporting company by means of a traditional underwritten initial public offering, security or industry analysts may not provide, or be less likely to provide, coverage of the Combined Company. Investment banks may also be less likely to agree to underwrite secondary offerings on behalf of the Combined Company than they might if the Combined Company became a public reporting company by means of a traditional underwritten initial public offering, because they may be less familiar with the Combined Company as a result of more limited coverage by analysts and the media. The failure to receive research coverage or support in the market for the Combined Company’s common stock could have an adverse effect on the Combined Company’s ability to develop a liquid market for the Combined Company’s common stock. See “— *Risks Related to the Combined Company’s Common Stock — If securities or industry analysts do not publish research or reports about the Combined Company, or publish negative reports, the Combined Company’s stock price and trading volume could decline.*”

The market price of the Combined Company's common stock is likely to be highly volatile, and you may lose some or all of your investment.

Following the Business Combination, the market price of Combined Company's common stock is likely to be highly volatile and may be subject to wide fluctuations in response to a variety of factors, including the following:

- the impact of COVID-19 pandemic on Nauticus' business;
- the inability to obtain or maintain the listing of the Combined Company's shares of common stock on Nasdaq;
- the inability to recognize the anticipated benefits of the Business Combination, which may be affected by, among other things, competition, Nauticus' ability to grow and manage growth profitably, and retain its key employees;
- changes in applicable laws or regulations;
- risks relating to the uncertainty of Nauticus' projected financial information;
- risks related to the organic and inorganic growth of Nauticus' business and the timing of expected business milestones; and
- the amount of redemption requests made by CLAQ's stockholders.

In addition, the stock markets have experienced extreme price and volume fluctuations that have affected and continue to affect the market prices of equity securities of many companies. These fluctuations have often been unrelated or disproportionate to the operating performance of those companies. Broad market and industry factors, as well as general economic, political, regulatory and market conditions, may negatively affect the market price of the Combined Company's common stock, regardless of the Combined Company's actual operating performance.

Volatility in the Combined Company's share price could subject the Combined Company to securities class action litigation.

In the past, securities class action litigation has often been brought against a company following a decline in the market price of its securities. If the Combined Company faces such litigation, it could result in substantial costs and a diversion of management's attention and resources, which could harm its business.

If securities or industry analysts do not publish research or reports about the Combined Company, or publish negative reports, the Combined Company's stock price and trading volume could decline.

The trading market for the Combined Company's common stock will depend, in part, on the research and reports that securities or industry analysts publish about the Combined Company. The Combined Company does not have any control over these analysts. If the Combined Company's financial performance fails to meet analyst estimates or one or more of the analysts who cover the Combined Company downgrade its common stock or change their opinion, the Combined Company's stock price would likely decline. If one or more of these analysts cease coverage of the Combined Company or fail to regularly publish reports on the Combined Company, it could lose visibility in the financial markets, which could cause the Combined Company's stock price or trading volume to decline.

Because the Combined Company does not anticipate paying any cash dividends in the foreseeable future, capital appreciation, if any, would be your sole source of gain.

The Combined Company currently anticipates that it will retain future earnings for the development, operation and expansion of its business and do not anticipate declaring or paying any cash dividends for the foreseeable future. As a result, capital appreciation, if any, of the Combined Company's shares of common stock would be your sole source of gain on an investment in such shares for the foreseeable future.

Future sales of shares of the Combined Company's common stock may depress its stock price.

Sales of a substantial number of the Combined Company's common stock in the public market after the closing of the Business Combination, or the perception that these sales might occur, could depress the market price of the Combined Company's common stock and could impair its ability to raise capital through the sale of additional equity securities.

The Combined Company is an emerging growth company, and the Combined Company cannot be certain if the reduced reporting requirements applicable to emerging growth companies will make its shares less attractive to investors.

After the completion of the Business Combination, the Combined Company will be an emerging growth company, as defined in the JOBS Act. For as long as the Combined Company continues to be an emerging growth company, it may take advantage of exemptions from various reporting requirements that are applicable to other public companies that are not "emerging growth companies," including exemption from compliance with the auditor attestation requirements of Section 404, reduced disclosure obligations regarding executive compensation and exemptions from the requirements of holding a nonbinding advisory vote on executive compensation and stockholder approval of any golden parachute payments not previously approved. The Combined Company will remain an emerging growth company until the earlier of (1) the date (a) July 19, 2026, (b) in which the Combined Company has total annual gross revenue of at least \$1.07 billion or (c) in which the Combined Company is deemed to be a large accelerated filer, which means the market value of shares of the Combined Company's common stock that are held by non-affiliates exceeds \$700 million as of the prior June 30th, and (2) the date on which the Combined Company has issued more than \$1.0 billion in non-convertible debt during the prior three-year period.

In addition, under the JOBS Act, emerging growth companies can delay adopting new or revised accounting standards until such time as those standards apply to private companies. The Combined Company has elected to use this extended transition period for complying with new or revised accounting standards and, therefore, the Combined Company will not be subject to the same new or revised accounting standards as other public companies that are not emerging growth companies.

Even after the Combined Company no longer qualifies as an emerging growth company, it may still qualify as a "smaller reporting company," which would allow it to take advantage of many of the same exemptions from disclosure requirements including exemption from compliance with the auditor attestation requirements of Section 404 and reduced disclosure obligations regarding executive compensation in this proxy statement/prospectus and the Combined Company's periodic reports and proxy statements.

The Combined Company cannot predict if investors will find its common stock less attractive because the Combined Company may rely on these exemptions. If some investors find the Combined Company's common stock less attractive as a result, there may be a less active trading market for the common stock and its market price may be more volatile.

Risks Related to the Combined Company Operating as a Public Company

Our management team has limited skills related to experience managing a public company.

Most members of our management team have limited experience managing a publicly traded company, interacting with public company investors, and complying with the increasingly complex laws, rules and regulations that govern public companies. As a public company, we are subject to significant obligations relating to reporting, procedures and internal controls, and our management team may not successfully or efficiently manage such obligations. These obligations and scrutiny will require significant attention from our management and could divert their attention away from the day-to-day management of our business, which could adversely affect our business, financial condition, and results of operations.

We will incur increased costs as a result of operating as a public company, and our management will be required to devote substantial time to new compliance initiatives and corporate governance practices.

As a public company, we will incur significant legal, accounting, and other expenses that we did not incur as a private company. The Sarbanes-Oxley Act, the Dodd-Frank Wall Street Reform and Consumer Protection Act, the listing requirements of Nasdaq and other applicable securities rules and regulations impose various requirements on public companies, including establishment and maintenance of effective disclosure and financial controls and corporate governance practices. Our management and other personnel continue to devote a substantial amount of time to these compliance initiatives. Moreover, these rules and regulations will continue to increase our legal and financial

compliance costs and will make some activities more time-consuming and costly. For example, we expect that these rules and regulations may make it more difficult and more expensive for us to obtain director and officer liability insurance and could also make it more difficult for us to attract and retain qualified members of our board.

We continue to evaluate these rules and regulations and cannot predict or estimate the amount of additional costs we may incur or the timing of such costs. These rules and regulations are often subject to varying interpretations, in many cases due to their lack of specificity, and, as a result, their application in practice may evolve over time as new guidance is provided by regulatory and governing bodies. This could result in continuing uncertainty regarding compliance matters and higher costs necessitated by ongoing revisions to disclosure and governance practices.

We are required to comply with the SEC's rules implementing Sections 302 and 404 of the Sarbanes-Oxley Act, which will require management to certify financial and other information in our annual reports and provide an annual management report on the effectiveness of control over financial reporting and will be required to disclose material changes in internal control over financial reporting on an annual basis.

We will not be required to make our first annual assessment of our internal control over financial reporting pursuant to Section 404 until our annual assessment for the fiscal year ending September 30, 2022.

To achieve compliance with Section 404 within the prescribed period, we will be engaged in a process to document and evaluate our internal control over financial reporting, which is both costly and challenging. In this regard, we will need to continue to dedicate internal resources, potentially engage outside consultants and adopt a detailed work plan to assess and document the adequacy of internal control over financial reporting, continue steps to improve control processes as appropriate, validate through testing that controls are functioning as documented and implement a continuous reporting and improvement process for internal control over financial reporting.

Despite our efforts, there is a risk that we will not be able to conclude, within the prescribed timeframe or at all, that our internal control over financial reporting is effective as required by Section 404. If we identify one or more material weaknesses, it could result in a material adverse reaction in the financial markets due to a loss of confidence in the reliability of our financial statements. As a result, the market price of our common stock could be negatively affected, and we could become subject to investigations by the stock exchange on which our securities are listed, the SEC or other regulatory authorities, which could require additional financial and management resources.

Our stock price has fluctuated historically and may continue to fluctuate.

Our stock price can be volatile. Among the factors that may affect the volatility of our stock price are the following:

- Speculation in the investment community or the press about, or actual changes in, our competitive position, organizational structure, executive team, operations, financial condition, financial reporting and results, expense discipline, strategic transactions, or progress on achieving expected benefits;
- The announcement of new products, services, acquisitions, or dispositions by us or our competitors;
- Increases or decreases in revenue or earnings, changes in earnings estimates by the investment community, and variations between estimated financial results and actual financial results; and
- Sales of a substantial number of shares of our common stock by large shareholders.

THE MEETING

General

CLAQ is furnishing this proxy statement/prospectus to the CLAQ stockholders as part of the solicitation of proxies by the Board for use at the Meeting of CLAQ stockholders to be held on _____, 2022 and at any adjournment or postponement thereof. This proxy statement/prospectus is first being furnished to our stockholders on or about _____, 2022 in connection with the vote on the Proposals. This proxy statement/prospectus provides you with the information you need to know to be able to vote or instruct your vote to be cast at the Meeting.

Date, Time and Place

The Meeting will be held virtually at _____ m., Eastern Time, on _____ and conducted exclusively via live audio cast at _____, or such other date, time and place to which such meeting may be adjourned or postponed, for the purposes set forth in the accompanying notice. There will not be a physical location for the Meeting, and you will not be able to attend the meeting in person. We are pleased to utilize the virtual stockholder meeting technology to provide ready access and cost savings for our stockholders and CLAQ. The virtual meeting format allows attendance from any location in the world. You will be able to attend, vote your shares, view the list of stockholders entitled to vote at the Meeting and submit questions during the Meeting via a live audio cast available at _____.

Virtual Meeting Registration

To register for the virtual meeting, please follow these instructions as applicable to the nature of your ownership of our common stock.

If your shares are registered in your name with Continental and you wish to attend the online-only virtual meeting, go to _____, enter the control number you received on your proxy card and click on the “Click here” to preregister for the online meeting link at the top of the page. Just prior to the start of the meeting you will need to log back into the meeting site using your control number. Pre-registration is recommended but is not required in order to participate in the virtual Meeting.

Beneficial stockholders who wish to participate in the online-only virtual meeting must obtain a legal proxy by contacting their account representative at the bank, broker, or other nominee that holds their shares and email a copy (a legible photograph is sufficient) of their legal proxy to _____. Beneficial stockholders who email a valid legal proxy will be issued a meeting control number that will allow them to register to attend and participate in the online-only meeting. After contacting Continental a beneficial holder will receive an email prior to the meeting with a link and instructions for entering the virtual Meeting. Beneficial stockholders should contact Continental at least five business days prior to the meeting date.

Accessing the Virtual Meeting Audio Cast

You will need your control number for access. If you do not have your control number, contact Continental at the phone number or email address below. Beneficial investors who hold shares through a bank, broker or other intermediary, will need to contact them and obtain a legal proxy. Once you have your legal proxy, contact Continental to have a control number generated. Continental contact information is as follows: 917-_____-_____-_____ or email proxy@continentalstock.com.

Record Date; Who is Entitled to Vote

CLAQ has fixed the close of business on _____, 2022, as the record date for determining those CLAQ stockholders entitled to notice of and to vote at the Meeting. As of the close of business on _____, 2022, there were 21,562,500 shares of common stock issued and outstanding and entitled to vote, of which 17,250,000 are Public Common Stock, 4,312,500 are founder shares held by the Initial Stockholders. Each holder of shares of common stock is entitled to one vote per share on each Proposal. If your shares are held in “street name,” you should contact your broker, bank or other nominee to ensure that shares held beneficially by you are voted in accordance with your instructions.

In connection with our IPO, we entered into certain letter agreements pursuant to which the Initial Stockholders agreed to vote any shares of common stock owned by them in favor of our initial business combination (the “Letter Agreement”). The Initial Stockholders also entered into a certain support agreement with Nauticus, pursuant to which they agreed to, among other things, vote in favor of the Business Combination Proposal and the other Proposals (the “Sponsor Support Agreement”). As of the date of this proxy statement/prospectus, the Initial Stockholders hold approximately 20.0% of the outstanding common stock.

Quorum and Required Vote for Shareholder Proposals

A quorum of CLAQ stockholders is necessary to hold a valid meeting. A quorum will be present at the Meeting if a majority of the shares of common stock issued and outstanding is present in person by virtual attendance or represented by proxy and entitled to vote at the Meeting. Abstentions by virtual attendance and by proxy will count as present for the purposes of establishing a quorum but broker non-votes will not.

Approval of the Business Combination Proposal, the Bylaws Proposal, the Stock Plan Proposal, the Nasdaq Merger Proposal, the Nasdaq PIPE Proposal, and the Adjournment Proposal will each require the affirmative vote of the holders of a majority of the issued and outstanding shares of common stock present in person by virtual attendance or represented by proxy and entitled to vote at the Meeting or any adjournment thereof. Approval of the Charter Approval Proposal will require the approval of a majority of the issued and outstanding shares of common stock. Attending the Meeting either in person by virtual attendance or represented by proxy and abstaining from voting and a broker non-vote will have the same effect as voting against the Charter Approval Proposal. Approval of the Directors Proposal will require a plurality of the votes cast.

Along with the approval of the Charter Approval Proposal, the Bylaws Proposal, the Directors Proposal, the Stock Plan Proposal, the Nasdaq Merger Proposal, the Nasdaq PIPE Proposal and the approval of the Business Combination Proposal are conditions to the consummation of the Business Combination. If the Business Combination Proposal is not approved, the Business Combination will not take place. Approval of this Business Combination Proposal is also a condition to Proposal 2, Proposal 3, Proposals 4A-4E, Proposal 5, Proposal 6, Proposal 7 and Proposal 8. If the Charter Approval Proposal, the Bylaws Proposal, the Directors Proposal, the Stock Plan Proposal, the Nasdaq Merger Proposal or the Nasdaq PIPE Proposal are not approved, unless waived, this Business Combination Proposal will have no effect (even if approved by the requisite vote of our stockholders at the Meeting of any adjournment or postponement thereof) and the Business Combination will not occur.

Voting Your Shares

Each share of common stock that you own in your name entitles you to one vote on each Proposal for the Meeting. Your proxy card shows the number of shares of common stock that you own.

There are two ways to ensure that your shares of common stock are voted at the Meeting:

- You can vote your shares by signing, dating and returning the enclosed proxy card in the prepaid postage envelope provided. If you submit your proxy card, your “proxy,” whose name is listed on the proxy card, will vote your shares as you instruct on the proxy card. If you sign and return the proxy card but do not give instructions on how to vote your shares, your shares will be voted, as recommended by our board. Our Board recommends voting “FOR” each of the Proposals. If you hold your shares of common stock in “street name,” which means your shares are held of record by a broker, bank or other nominee, you should follow the instructions provided to you by your broker, bank or nominee to ensure that the votes related to the shares you beneficially own are properly represented and voted at the Meeting.
- You can participate in the virtual Meeting and vote during the Meeting even if you have previously voted by submitting a proxy as described above. However, if your shares are held in the name of your broker, bank or another nominee, you must get a proxy from the broker, bank or other nominee. That is the only way CLAQ can be sure that the broker, bank or nominee has not already voted your shares.

IF YOU RETURN YOUR PROXY CARD WITHOUT AN INDICATION OF HOW YOU WISH TO VOTE, YOUR SHARES WILL BE VOTED IN FAVOR OF THE BUSINESS COMBINATION PROPOSAL (AS WELL AS THE OTHER PROPOSALS).

Revoking Your Proxy

If you give a proxy, you may revoke it at any time before it is exercised by doing any one of the following:

- you may send another proxy card with a later date;
- if you are a record holder, you may notify our proxy solicitor, Advantage Proxy, in writing before the Meeting that you have revoked your proxy; or
- you may participate in the virtual Meeting, revoke your proxy, and vote during the virtual Meeting, as indicated above.

Who Can Answer Your Questions About Voting Your Shares

If you have any questions about how to vote or direct a vote in respect of your shares of common stock, you may contact Advantage Proxy, our proxy solicitor as follows:

ADVANTAGE PROXY
P.O. Box 13581
Des Moines, WA 98198
Toll Free: (877) 870-8565
Collect: (206) 870-8565
Email: ksmith@advantageproxy.com

No Additional Matters May Be Presented at the Meeting

This Meeting has been called only to consider the approval of the Business Combination Proposal, the Charter Approval Proposal, the Bylaws Proposal, the Governance Proposals, the Directors Proposal, the Stock Plan Proposal, the Nasdaq Merger Proposal, the Nasdaq PIPE Proposal, and the Adjournment Proposal. Under our Certificate of Incorporation, other than procedural matters incident to the conduct of the Meeting, no other matters may be considered at the Meeting if they are not included in the notice of the Meeting.

Approval of the Business Combination Proposal, the Bylaws Proposal, the Governance Proposals, the Directors Proposal, the Stock Plan Proposal, the Nasdaq Merger Proposal, the Nasdaq PIPE Proposal, and the Adjournment Proposal will each require the affirmative vote of the holders of a majority of the issued and outstanding shares of common stock present in person by virtual attendance or represented by proxy and entitled to vote at the Meeting or any adjournment thereof. Approval of the Charter Approval Proposal will require the approval of a majority of the issued and outstanding shares of common stock.

Redemption Rights

Pursuant to our Certificate of Incorporation, a holder of Common Stock may demand that CLAQ redeem such Common Stock for cash in connection with a business combination. You may not elect to redeem your Common Stock prior to the completion of a business combination.

If you are a public stockholder and you seek to have your shares redeemed, you must submit your request in writing that we redeem your Public Common Stock for cash no later than _____ a.m./p.m., Eastern Time on _____, 2022 (at least two business days before the Meeting). The request must be signed by the applicable stockholder in order to validly request redemption. A stockholder is not required to submit a proxy card or vote in order to validly exercise redemption rights. The request must identify the holder of the Common Stock to be redeemed and must be sent to Continental at the following address:

Continental Stock Transfer & Trust Company

1 State Street, 30th floor
New York, NY 10004
Attention:
Email:

You must tender the Common Stock for which you are electing redemption at least two business days before the Meeting by either:

- Delivering certificates representing the Common Stock to Continental, or
- Delivering the Common Stock electronically through the DWAC system.

Any corrected or changed written demand of redemption rights must be received by Continental at least two business days before the Meeting. No demand for redemption will be honored unless the holder's shares have been delivered (either physically or electronically) to Continental at least two business days prior to the vote at the Meeting.

[Table of Contents](#)

Public stockholders may seek to have their Common Stock redeemed regardless of whether they vote for or against the Business Combination and whether or not they are holders of Common Stock as of the Record Date. Any public stockholder who holds Common Stock of CLAQ on or before _____, 2022 (at least two business days before the Meeting) will have the right to demand that his, her or its Common Stock be redeemed for a pro rata share of the aggregate amount then on deposit in the Trust Account, less any taxes then due but not yet paid, at the consummation of the Business Combination.

In connection with tendering your shares for redemption, you must elect either to physically tender your certificates to Continental or deliver your Common Stock to Continental electronically using DTC's DWAC (Deposit/Withdrawal At Custodian) System, in each case, at least two business days before the Meeting.

If you wish to tender through the DWAC system, please contact your broker and request delivery of your Common Stock through the DWAC system. Delivering Common Stock physically may take significantly longer. In order to obtain a physical certificate, a stockholder's broker and/or clearing broker, DTC, and Continental will need to act together to facilitate this request. It is CLAQ's understanding that stockholders should generally allot at least two weeks to obtain physical certificates from Continental. CLAQ does not have any control over this process or over the brokers or DTC, and it may take longer than two weeks to obtain a physical certificate. Stockholders who request physical certificates and wish to redeem may be unable to meet the deadline for tendering their Common Stock before exercising their redemption rights and thus will be unable to redeem their Common Stock.

In the event that a stockholder tenders its Common Stock and decides prior to the consummation of the Business Combination that it does not want to redeem its Common Stock, the stockholder may withdraw the tender. In the event that a stockholder tenders Common Stock and the Business Combination is not completed, these Common Stock will not be redeemed for cash and the physical certificates representing these Common Stock will be returned to the stockholder promptly following the determination that the Business Combination will not be consummated. CLAQ anticipates that a stockholder who tenders Common Stock for redemption in connection with the vote to approve the Business Combination would receive payment of the redemption price for such Common Stock soon after the completion of the Business Combination.

If properly demanded by CLAQ's public stockholders, CLAQ will redeem each Common Stock into a pro rata portion of the funds available in the Trust Account, calculated as of two business days prior to the anticipated consummation of the Business Combination. As of _____, 2022, this would amount to approximately \$10.10 per share. If you exercise your redemption rights, you will be exchanging your Common Stock for cash and will no longer own the Common Stock.

Notwithstanding the foregoing, a holder of the Common Stock, together with any affiliate of his or her or any other person with whom he or she is acting in concert or as a "group" (as defined in Section 13(d)-(3) of the Exchange Act) will be restricted from seeking redemption rights with respect to more than 20% of the Common Stock.

If too many public stockholders exercise their redemption rights, we may not be able to meet certain closing conditions, and as a result, would not be able to proceed with the Business Combination.

Appraisal Rights

Appraisal rights are not available to security holders of CLAQ in connection with the proposed Business Combination.

Proxies and Proxy Solicitation Costs

CLAQ is soliciting proxies on behalf of the Board. This solicitation is being made by mail but also may be made by telephone or in person. CLAQ and its directors, officers and employees may also solicit proxies in person, by telephone or by other electronic means. Any solicitation made and information provided in such a solicitation will be consistent with the written proxy statement/prospectus and proxy card. CLAQ will bear the cost of solicitation. Advantage Proxy, a proxy solicitation firm that CLAQ has engaged to assist it in soliciting proxies, will be paid a fixed fee of approximately \$10,000 and be reimbursed out-of-pocket expenses.

CLAQ will ask banks, brokers and other institutions, nominees and fiduciaries to forward its proxy materials to their principals and to obtain their authority to execute proxies and voting instructions. CLAQ will reimburse them for their reasonable expenses.

PROPOSAL 1 — THE BUSINESS COMBINATION PROPOSAL

We are asking our stockholders to adopt the Merger Agreement and approve the Business Combination and the other transactions contemplated thereby. Our stockholders should read carefully this proxy statement/prospectus in its entirety, including the subsection below titled “*The Merger Agreement*,” for more detailed information concerning the Business Combination and the terms and conditions of the Merger Agreement. We also urge our stockholders to read carefully the Merger Agreement in its entirety before voting on this Proposal. A copy of the Merger Agreement is attached as *Annex A* to this proxy statement/prospectus.

General

On December 16, 2021, CleanTech Acquisition Corp., a Delaware corporation (“CleanTech” or “CLAQ”), entered into an Agreement and Plan of Merger (the “Merger Agreement,” and together with the other agreements and transactions contemplated by the Merger Agreement, the “Business Combination”) with CleanTech Merger Sub, Inc., a Delaware corporation and a wholly owned subsidiary of CleanTech (“Merger Sub”), and Nauticus Robotics, Inc., a Texas corporation (“Nauticus” or “Nauticus Robotics”). Pursuant to the terms of the Merger Agreement, a business combination between CleanTech and Nauticus will be effected through the merger of Merger Sub with and into Nauticus, with Nauticus surviving the merger as a wholly owned subsidiary of CleanTech (the “Merger”). The Board of Directors of CleanTech (the “Board”) has unanimously (i) approved and declared advisable the Merger Agreement, the Merger and the other transactions contemplated thereby and (ii) resolved to recommend approval of the Merger Agreement and related matters by the stockholders of CleanTech. On January 30, 2022, the Merger Agreement was amended to, among other things, (i) correct certain defined terms in the Merger Agreement; and (ii) include the cash available from the Debt Financing in meeting the “Minimum Cash Condition” defined in the Merger Agreement. On June 6, 2022, the Merger Agreement was further amended to increase the aggregate number of shares of the Combined Company’s Common stock to be reserved for issuance pursuant to the Incentive Plan (defined below) from 5% to 10% of the fully diluted outstanding shares of its Common Stock after Closing, which share reserve shall be automatically increased on an annual basis by 3% of the total number of Common Stock outstanding as provided under the Incentive Plan.

The Merger Agreement

The following is a summary of the material terms of the Merger Agreement. The following summary does not purport to be complete and is qualified in its entirety by reference to the Merger Agreement, a copy of which is attached as *Annex A* to this proxy statement/prospectus.

The Merger Agreement contains representations and warranties that CLAQ and Merger Sub, on the one hand, and Nauticus, on the other hand, have made to one another as of specific dates. The assertions embodied in the representations and warranties are qualified by information in confidential disclosure schedules exchanged by the parties to the Merger Agreement. Some of these schedules contain information that modifies, qualifies and creates exceptions to the representations and warranties set forth in the Merger Agreement. You should not rely on the representations and warranties described below as current characterizations of factual information about CLAQ or Nauticus, because they were made as of specific dates, may be intended merely as a risk allocation mechanism between CLAQ and Merger Sub, and Nauticus and are modified by the disclosure schedules.

The Merger Consideration

The Business Combination implies a \$561 million post-closing equity value and a current equity value of Nauticus at \$300 million. Prior to the Closing, Nauticus will (i) effect the Nauticus Preferred Stock Conversion, (ii) effect the Nauticus Convertible Notes Conversion, and (iii) convert each share of Nauticus Common Stock (including shares of Nauticus Common Stock outstanding as a result of the Nauticus Preferred Stock Conversion and Nauticus Convertible Notes Conversion, but excluding shares of the holders who perfect rights of appraisal under Delaware law) into the right to receive (a) the Per Share Merger Consideration and (b) Earnout Shares. As a result of these transactions, each outstanding share of Nauticus Common Stock will have a value at the time of the Business Combination of \$10.00 (based on the \$300 million equity value of Nauticus).

In addition, in connection with the Closing, CLAQ will issue the Earn-Out Shares to the former holders of Nauticus Common Stock and such holders will deliver the Earnout-Out Shares to the Escrow Agent. The release of the Earn-Out Shares to the former holders of Nauticus Common Stock will be subject to restrictions linked to milestones (based on the achievement of certain target prices of CleanTech Common Stock following the Closing) as further described in the section entitled “*Proposal 1 — The Business Combination Proposal — The Merger*”

Agreement — Treatment of Nauticus Securities — Earn-Out Shares.” In the event such milestones are not met, all of the Earn-Out Shares will be automatically released to CleanTech for cancellation and the former holders of Nauticus Common Stock shall not have any right to receive such Earnout Shares or any benefit therefrom.

Treatment of Nauticus Securities

Preferred Stock. Immediately prior to the Effective Time, each share of Nauticus Preferred Stock that is issued and outstanding immediately prior to such time shall automatically convert into shares of Nauticus Common stock, par value \$0.01 per share (the “Nauticus Common Stock”), in accordance with its Certificate of Incorporation (collectively, the “Nauticus Preferred Stock Conversion”). As a result of the Merger, an aggregate of 15,062,524 shares of CLAQ Common Stock will be issued to the holders of Nauticus Preferred Stock.

Convertible Notes. Immediately prior to the Effective Time, each of (i) that certain Unsecured Convertible Promissory Note, dated June 19, 2021, by and between Goradia Capital, LLC and Nauticus, as amended on December 16, 2021, (ii) that certain Unsecured Convertible Promissory Note, August 3, 2021, by and between Material Impact Fund II, L.P. and Nauticus, as amended on December 16, 2021, (iii) that certain Unsecured Convertible Promissory Note, dated October 22, 2021, by and between In-Q-Tel, Inc. and Nauticus, as amended on December 16, 2021, (iv) that certain Unsecured Convertible Promissory Note, dated July 28, 2020, by and between Schlumberger Technology Corporation and Nauticus, as amended on December 16, 2021 and (v) that certain Unsecured Convertible Promissory Note, dated December 7, 2020, by and between Transocean Inc. and Nauticus, as amended on December 16, 2021 (each, a “Nauticus Convertible Note” and collectively, the “Nauticus Convertible Notes”) shall automatically convert into shares of Nauticus Common Stock in accordance with the terms of each such Nauticus Convertible Note (collectively, the “Nauticus Convertible Notes Conversion”). As a result of the Merger, an aggregate of 5,299,543 shares of CLAQ Common Stock will be issued to the holders of Nauticus Convertible Notes. Please see *“Risk Factors — CLAQ’s stockholders will experience immediate dilution as a consequence of the issuance of common stock as consideration in the Business Combination, PIPE Investment and the Nauticus Convertible Notes Conversion. Having a minority share position may reduce the influence that CLAQ’s current stockholders have on the management of CLAQ”* for dilution considerations.

Common Stock. At the Effective Time, following the Nauticus Preferred Stock Conversion and Nauticus Convertible Notes Conversion, each share of Nauticus Common Stock (including shares of Nauticus Common Stock outstanding as a result of the Nauticus Preferred Stock Conversion and Nauticus Convertible Notes Conversion, but excluding shares of the holders of which perfect rights of appraisal under Delaware law) will be converted into the right to receive the Per Share Merger Consideration and the Earnout Shares (as defined below). As a result of the Merger, an aggregate of 9,669,216 shares of CLAQ Common Stock will be issued to the holders of Nauticus Common Stock (not including the Earnout Shares).

Stock Options. At the Effective Time, each outstanding option to purchase shares of Nauticus Common Stock (a “Nauticus Option”), whether or not then vested and exercisable, will be assumed by CLAQ and converted automatically (and without any required action on the part of such holder of outstanding option) into an option to purchase shares of the CLAQ’s Common Stock equal to the number of shares determined by multiplying the number of shares of the Nauticus Common Stock subject to such Nauticus Option immediately prior to the Effective Time by the Exchange Ratio, which product shall be rounded down to the nearest whole number of shares, at a per share exercise price determined by dividing the per share exercise price of such Nauticus Option immediately prior to the Effective Time by the Exchange Ratio. As a result of the Merger, an aggregate of 3,977,368 shares of CLAQ Common Stock will be issuable upon exercise of these options.

Earnout Shares. Following the closing of the merger, former holders of shares of Nauticus Common Stock (including shares received as a result of the Nauticus Preferred Stock conversion and the Nauticus Convertible Notes conversion, the “Stockholder Earnout Group”) shall be entitled to receive their pro rata share of up to 7,500,000 additional shares of CleanTech Common Stock (the “Earnout Shares”). The Earnout Shares will be released and delivered to the Stockholder Earnout Group upon occurrence of the following (each, a “Triggering Event”):

- (i) one-half of the Escrow Shares will be released if, within a 5-year period following the signing date of the Merger Agreement, the volume-weighted average price of the Combined Company Common Stock equals or exceeds \$15.00 per share, over any 20 trading days within a 30-day trading period;
- (ii) one-quarter of the Escrow Shares will be released if, within a 5-year period following the signing date of the Merger Agreement, the volume-weighted average price of the Combined Company Common Stock equals or exceeds \$17.50 per share over any 20 trading days within a 30-day trading period; and

[Table of Contents](#)

- (iii) one-quarter of the Escrow Shares will be released if, within a 5-year period following the signing date of the Merger Agreement, the volume-weighted average price of the Combined Company Common Stock equals or exceeds \$20.00 per share over any 20 trading days within a 30-day trading period.

Representations and Warranties

The Merger Agreement contains customary representations and warranties of the parties thereto with respect to, among other things, (a) entity organization, good standing and qualification, (b) capital structure, (c) authorization to enter into the Merger Agreement, (d) compliance with laws and permits, (e) taxes, (f) financial statements and internal controls, (g) real and personal property, (h) material contracts, (i) environmental matters, (j) absence of changes, (k) employee matters, (l) litigation, and (m) brokers and finders.

Covenants

The Merger Agreement includes customary covenants of the parties with respect to operation of their respective businesses prior to consummation of the Merger and efforts to satisfy conditions to consummation of the Merger. The Merger Agreement also contains additional covenants of the parties, including, among others, covenants providing for CleanTech and Nauticus to use reasonable best efforts to cooperate in the preparation of the Registration Statement and Proxy Statement (as each such term is defined in the Merger Agreement) required to be filed in connection with the Merger and to obtain all requisite approvals of their respective stockholders including, in the case of CleanTech, approvals of the restated certificate of incorporation, the share issuance under Nasdaq rules and the omnibus incentive plan. CleanTech has also agreed to include in this proxy statement/prospectus the recommendation of its board that stockholders approve all of the proposals to be presented at the special meeting.

Nauticus Robotics, Inc. Incentive Plan

CleanTech has agreed to approve and adopt a 2022 omnibus incentive plan (the "Incentive Plan") to be effective as of the Closing and in a form mutually acceptable to CleanTech and Nauticus. The Incentive Plan shall provide for an initial aggregate share reserve equal to 10% of the number of shares of CleanTech Common Stock on a fully diluted basis at the Closing. Subject to approval of the Incentive Plan by the CleanTech's stockholders, CleanTech has agreed to file a Form S-8 Registration Statement with the SEC following the Effective Time with respect to the shares of CleanTech Common Stock issuable under the Incentive Plan.

Non-Solicitation Restrictions

Each of CleanTech and Nauticus has agreed that from the date of the Merger Agreement to the Effective Time or, if earlier, the valid termination of the Merger Agreement in accordance with its terms, it will not initiate any negotiations with any party, or provide non-public information or data concerning it or its subsidiaries to any party relating to an Acquisition Proposal or Alternative Transaction (as such terms are defined in the Merger Agreement) or enter into any agreement relating to such a proposal. Each of CleanTech and Nauticus has also agreed to use its reasonable best efforts to prevent any of its representatives from doing the same.

Conditions to Closing

The consummation of the Merger is conditioned upon, among other things, (i) receipt of the CleanTech stockholder approval and Nauticus stockholder approval, (ii) the expiration or termination of the waiting period under the Hart-Scott-Rodino Antitrust Improvements Act of 1976, as amended, (iii) the absence of any governmental order, statute, rule or regulation enjoining or prohibiting the consummation of the Transactions, (iv) the effectiveness of the Registration Statement under the Securities Act, (v) CleanTech having at least \$5,000,001 of net tangible assets (as determined in accordance with Rule 3a51-1(g)(1) of the Securities Exchange Act of 1934, as amended (the "Exchange Act")), (vi) solely with respect to CleanTech, (A) the representations and warranties of Nauticus being true and correct to applicable standards applicable and each of the covenants of Nauticus having been performed or complied with in all material respects and (B) the approval of the conversion of the convertible notes and (vii) solely with respect to Nauticus, (A) the representations and warranties of CleanTech being true and correct to applicable standards applicable and each of the covenants of CleanTech having been performed or complied with in all material respects (B) the receipt of the approval for listing by Nasdaq of the shares of CleanTech Common Stock to be issued in connection with the transactions contemplated by the Merger Agreement, (C) the effective resignations of certain directors and executive officers of CleanTech, (D) the amount of Minimum Cash Condition (as defined in the Merger Agreement) being equal to or exceeding \$50,000,000.

Termination

The Merger Agreement may be terminated at any time prior to the Effective Time as follows:

- (i) by mutual written consent of CleanTech and Nauticus;
- (ii) by either CleanTech or Nauticus if the other party has breached its representations, warranties, covenants or agreements in the Merger Agreement such that the conditions to closing cannot be satisfied and such breach cannot be cured within certain specified time periods, provided that the party seeking to breach is not itself in breach of the Merger Agreement;
- (iii) by either CleanTech or Nauticus if the transactions are not consummated on or before June 30, 2022, provided that the failure to consummate the transaction by that date is not due to a material breach by the party seeking to terminate and which such breach is the proximate cause for the conditions to close not being satisfied;
- (iv) by either CleanTech or Nauticus if a governmental entity shall have issued a law or final, non-appealable governmental order, rule or regulation permanently enjoining or prohibiting the consummation of the Merger, provided that, the party seeking to terminate cannot have breached its obligations under the Merger Agreement and such breach has proximately contributed to the governmental action;
- (v) by either CleanTech or Nauticus if the CleanTech stockholders do not approve the Merger Agreement at a meeting held for that purpose;
- (vi) by written notice from CleanTech to Nauticus if the Nauticus stockholders do not approve the Merger Agreement due to the failure of Nauticus to hold a stockholder vote; or
- (vii) by written notice from Nauticus to CleanTech if the CleanTech board shall have publicly withdrawn, modified or changed in an adverse manner its recommendation to vote in favor of the merger and other proposals.

The Merger Agreement and other agreements described below have been included to provide investors with information regarding their respective terms. They are not intended to provide any other factual information about CleanTech, Nauticus or the other parties thereto. In particular, the assertions embodied in the representations and warranties in the Merger Agreement were made as of a specified date, are modified or qualified by information in one or more confidential disclosure letters prepared in connection with the execution and delivery of the Merger Agreement, may be subject to a contractual standard of materiality different from what might be viewed as material to investors, or may have been used for the purpose of allocating risk between the parties. Accordingly, the representations and warranties in the Merger Agreement are not necessarily characterizations of the actual state of facts about CleanTech, Nauticus or the other parties thereto at the time they were made or otherwise and should only be read in conjunction with the other information that CleanTech makes publicly available in reports, statements and other documents filed with the SEC. CleanTech and Nauticus investors and securityholders are not third-party beneficiaries under the Merger Agreement.

Opinion of CLAQ's Financial Advisor

On January 28, 2022, CLAQ retained Duff & Phelps to serve as an independent financial advisor to the Board of CLAQ, specifically to provide to the Board a fairness opinion in connection with the Business Combination. On March 24, 2022, Duff & Phelps delivered its opinion, dated March 24, 2022 (the "Opinion"), to the Board of CLAQ (solely in their capacity as members of the Board) that, as of the date of the Opinion and subject to and based on the assumptions made, procedures followed, matters considered, limitations of the review undertaken and qualifications contained in the Opinion, the consideration to be paid by CLAQ (in the form of CLAQ common stock, the "Consideration") to the Nauticus securityholders in the Business Combination pursuant to the Merger Agreement is fair to CLAQ, from a financial point of view.

In selecting Duff & Phelps, the Board considered, among other things, the fact that Duff & Phelps is a global leader in providing fairness opinions to boards of directors. Duff & Phelps is regularly engaged in the valuation of businesses and their securities and the provision of fairness opinions in connection with various transactions.

The Opinion was approved by Duff & Phelps' fairness opinions committee. The Opinion was provided for the information of, and directed to, the Board for its information and assistance in connection with the Business Combination.

The full text of the Opinion is attached to this proxy statement/prospectus as Annex F and is incorporated into this document by reference. The summary of the Opinion set forth herein is qualified in its entirety by reference to the full text of the Opinion. CLAQ's stockholders are urged to read the Opinion carefully and in its entirety for a discussion of the procedures followed, assumptions made, matters considered, limitations of the review undertaken by Duff & Phelps in connection with the Opinion, as well as other qualifications contained in the Opinion.

In connection with the Opinion, Duff & Phelps made such reviews, analyses and inquiries as it deemed necessary and appropriate under the circumstances to enable Duff & Phelps to render the Opinion. Duff & Phelps also took into account its assessment of general economic, market and financial conditions, as well as its experience in securities and business valuation in general, and with respect to similar transactions in particular. Duff & Phelps' procedures, investigations and financial analyses with respect to the preparation of the Opinion included, but were not limited to, the items summarized below:

- reviewed the Merger Agreement and the initial filing of this proxy statement/prospectus filed on January 31, 2022;
- reviewed unaudited financial information for Nauticus for the year ended December 31, 2021 and December 31, 2020 and audited financial information for Nauticus for the year ended December 31, 2020;
- reviewed financial projections for the Combined Company for the calendar years 2022 through 2024, provided to us by management of Nauticus, approved for our use by management of CLAQ and included in the initial filing of this proxy statement/prospectus filed on January 31, 2022 (the "Financial Projections"), which are described in the section of this proxy statement/prospectus entitled "*Certain Nauticus' Projected Financial Information*";
- reviewed the Nauticus Investor Presentation dated December 2021;
- discussed the information referred to above and the background and other elements of the Business Combination with the management of CLAQ and certain members of the Board of CLAQ (in their capacity as members of the Board);
- discussed with CLAQ management the plans and intentions with respect to the management and operation of the Combined Company following the completion of the Business Combination;
- discussed with CLAQ management and certain members of the Board of CLAQ (in their capacity as members of the Board) their assessment of the strategic rationale for, and the potential benefits of, the Business Combination;
- performed certain valuation and comparative analyses using generally accepted valuation and analytical techniques, including a discounted cash flow analysis and an analysis of selected public companies that Duff & Phelps deemed relevant for comparison to Nauticus, as further described below in this section entitled "*Opinion of CLAQ's Financial Advisor*"; and
- conducted such other analyses and considered such other factors as Duff & Phelps deemed appropriate.

In performing its analyses and rendering the Opinion with respect to the Business Combination, Duff & Phelps, with CLAQ's consent:

- relied upon the accuracy, completeness, and fair presentation of all information, data, advice, opinions and representations obtained from public sources or provided to it from private sources, including CLAQ and Nauticus and their respective management, including all financial, legal, regulatory, tax, accounting and other information provided to, discussed with or reviewed by us, and did not independently verify such information;
- relied upon the fact that the Board and CLAQ have been advised by counsel as to all legal matters with respect to the Business Combination, including whether all procedures required by law to be taken in connection with the Business Combination have been duly, validly and timely taken;

[Table of Contents](#)

- assumed that any estimates, evaluations, forecasts and projections and other pro forma information, including the Financial Projections, furnished to Duff & Phelps were reasonably prepared and based upon the best currently available information and good faith judgment of the person(s) furnishing the same, and Duff & Phelps expressed no opinion with respect to such estimates, evaluations, forecasts and projections and other pro forma information or any underlying assumptions;
- assumed that information supplied by and representations made by CLAQ and Nauticus and their respective management are substantially accurate regarding CLAQ, Nauticus and the Business Combination;
- assumed that the representations and warranties made in the Merger Agreement are substantially accurate;
- assumed that the final versions of all documents reviewed by Duff & Phelps in draft form conform in all material respects to the drafts reviewed;
- assumed that the PIPE Investment will occur as contemplated by the draft documents reviewed by Duff & Phelps and as described by management of Nauticus and CLAQ;
- assumed that there has been no material change in the assets, liabilities, financial condition, results of operations, business, or prospects of CLAQ or Nauticus since the date of the most recent financial statements and other information made available to Duff & Phelps, and that there is no information or facts that would make the information reviewed by Duff & Phelps incomplete or misleading;
- assumed that all of the conditions required to implement the Business Combination will be satisfied and that the Business Combination will be completed in a timely manner in accordance with the Merger Agreement without any material amendments thereto or any waivers of any terms or conditions thereof; and
- assumed that the consummation of the Business Combination will comply in all respects with all applicable foreign, federal, state and local statutes, rules and regulations and that all governmental, regulatory or other consents and approvals necessary for the consummation of the Business Combination will be obtained without any adverse effect, that would be material to Duff & Phelps' analysis, on CLAQ, Nauticus, the Combined Company or the contemplated benefits expected to be derived in the Business Combination.

Given CLAQ's nature as a special purpose acquisition company, for purposes of the Opinion and its analysis and with CLAQ's consent, Duff & Phelps assumed a value of \$10.00 per share for CLAQ's Common Stock, with such \$10.00 value being based on CLAQ's initial public offering and CLAQ's approximate cash per outstanding share of CLAQ Common Stock (excluding, for the avoidance of doubt, the dilutive impact of founder shares or any Public Warrants, Private Warrants or Rights). Further, for purposes of the Opinion and its analysis and with CLAQ's consent, Duff & Phelps assumed the accuracy and completeness of the capitalization information for the Combined Company prepared by CLAQ, pro forma for the Business Combination and the PIPE Investment.

To the extent that any of the foregoing assumptions, representations or any of the facts on which the Opinion is based prove to be untrue in any material respect, the Opinion cannot and should not be relied upon. Furthermore, in Duff & Phelps' analysis and in connection with the preparation of the Opinion, Duff & Phelps has made numerous assumptions with respect to industry performance, general business, market and economic conditions and other matters, many of which are beyond the control of any party involved in the Business Combination.

Duff & Phelps prepared the Opinion effective as of the date thereof. The Opinion was necessarily based upon market, economic, financial and other conditions as they then existed and could be evaluated as of the date thereof, and Duff & Phelps disclaims any undertaking or obligation to advise any person of any change in any fact or matter affecting the Opinion which may come or be brought to the attention of Duff & Phelps after the date thereof.

Duff & Phelps did not evaluate the solvency of CLAQ or Nauticus or conduct an independent appraisal or physical inspection of any specific assets or liabilities (contingent, derivative, off-balance sheet or otherwise). Duff & Phelps was not requested to, and did not, (i) initiate any discussions with, or solicit any indications of interest from, third parties with respect to the Business Combination, the assets, businesses or operations of CLAQ or any alternatives to the Business Combination, (ii) negotiate the terms of the Business Combination, and therefore, Duff & Phelps assumed that such terms are the most beneficial terms, from CLAQ's perspective, that could, under the circumstances, be negotiated among the parties to the Merger Agreement and the Business Combination, or (iii) advise the Board of CLAQ or any other party with respect to alternatives to the Business Combination.

[Table of Contents](#)

Duff & Phelps assumed that the Merger will qualify, for US federal income tax purposes, as a “reorganization” within the meaning of Section 368(a) of the Internal Revenue Code of 1986, as amended. Duff & Phelps was not expressing any view or rendering any opinion regarding the tax consequences of the Merger to CLAQ, Nauticus, or their respective shareholders.

In rendering the Opinion, Duff & Phelps was not expressing any opinion as to the market price or value of CLAQ’s Common Stock or the equity of Nauticus (or anything else) either before or after the consummation of the Business Combination or how any such shares may trade at any time. The Opinion should not be construed as a valuation opinion, credit rating, solvency opinion, an analysis of CLAQ’s credit worthiness, as tax advice or as accounting advice. Duff & Phelps did not make, and assumed no responsibility to make, any representation, or render any opinion, as to any legal matter.

In rendering the Opinion, Duff & Phelps was not expressing any opinion with respect to the amount or nature of any compensation to any of CLAQ’s or Nauticus’ officers, directors or employees, or any class of such persons, relative to the Consideration, or with respect to the fairness of any such compensation.

Duff & Phelps’ Opinion was furnished for the use and benefit of the Board of CLAQ in connection with the Business Combination and was not intended to, and does not, confer any rights or remedies upon any other person, and is not intended to be used, and may not be used, by any other person or for any other purpose, without Duff & Phelps’ express consent. Duff & Phelps has consented to the inclusion of the Opinion in its entirety and the description hereof in this proxy statement/prospectus and any other filing CLAQ is required to make with the SEC in connection with the Business Combination if such inclusion is required by the applicable law. The Opinion (i) did not address the merits of the underlying business decision to enter into the Business Combination versus any alternative strategy or transaction; (ii) did not address or express any view on any transaction related to the Business Combination, including the PIPE investment; (iii) was not a recommendation as to how the Board of CLAQ or any stockholder of CLAQ or Nauticus should vote or act with respect to any matters relating to the Business Combination, or whether to proceed with the Business Combination or any related transaction; and (iv) did not indicate that the Consideration is the best possibly attainable by CLAQ under any circumstances; instead, it merely stated whether the Consideration is within or below a range suggested by certain financial analyses. The decision as to whether to proceed with the Business Combination or any related transaction may depend on an assessment of factors unrelated to the financial analysis on which the Opinion was based. The Opinion should not be construed as creating any fiduciary duty on the part of Duff & Phelps to any party.

Except for the Opinion, Duff & Phelps did not express any view or opinion as to (i) any other term, aspect or implication of (a) the Business Combination (including, without limitation, the form or structure of the Business Combination) or the Merger Agreement or (b) any other agreement, transaction document or instrument contemplated by the Merger Agreement or to be entered into or amended in connection with the Business Combination or (ii) the fairness, financial or otherwise, of the Business Combination to, or of any consideration to be paid to or received by, the holders of any class of securities of CLAQ or Nauticus (including, without limitation, the fairness or the potential dilutive or other effects of the Business Combination or the PIPE Investment). The Opinion did not in any way address proportionate allocation or relative fairness (including, without limitation, the allocation of any consideration among or within any classes or groups of security holders or other constituents of CLAQ or any other party). Duff & Phelps also did not address, or express a view with respect to, any acquisition of control or effective control of the Combined Company by any stockholder or group of stockholders of Nauticus (including, without limitation, any voting, control, consent rights or similar rights, preferences or privileges as among or in comparison to any classes or groups of security holders or other constituents of CLAQ, Nauticus, the Combined Company or any other party). The Opinion did not in any way address the appropriate capital structure of the Combined Company, whether the Combined Company should be issuing debt or equity securities or a combination of both in the Business Combination, or the form, structure or any aspect or terms of any debt or equity financing for the Business Combination (including, without limitation, the PIPE Investment) or the likelihood of obtaining such financing, or whether or not Nauticus, CLAQ, their respective security holders or any other party is receiving or paying reasonably equivalent value in the Business Combination.

Set forth below is a summary of the material analyses performed by Duff & Phelps in connection with the delivery of the Opinion to the Board of CLAQ. This summary is qualified in its entirety by reference to the full text of the Opinion, attached to this proxy statement/prospectus as [Annex E](#). While this summary describes the analyses and factors that Duff & Phelps deemed material in its presentation to the Board of CLAQ, it is not a comprehensive description of all analyses and factors considered by Duff & Phelps. The preparation of a fairness opinion is a complex process that involves various determinations as to appropriate and relevant methods of financial analysis and the

application of these methods to the particular circumstances. Therefore, a fairness opinion is not readily susceptible to partial analysis or summary description. In arriving at the Opinion, Duff & Phelps did not attribute any particular weight to any analysis or factor considered by it, but rather made qualitative judgments as to the significance and relevance of each analysis and factor. Accordingly, Duff & Phelps believes that its analyses must be considered as a whole and that selecting portions of its analyses and of the factors considered by it in rendering the Opinion without considering all analyses and factors could create a misleading or incomplete view of the evaluation process underlying the Opinion. The conclusion reached by Duff & Phelps was based on all analyses and factors taken as a whole, and also on the application of Duff & Phelps' own experience and judgment.

The financial analyses summarized below include information presented in tabular format. In order for Duff & Phelps' financial analyses to be fully understood, the tables must be read together with the text of each summary. The tables alone do not constitute a complete description of the financial analyses. Considering the data below without considering the full narrative description of the financial analyses, including the methodologies and assumptions underlying the analyses, could create a misleading or incomplete view of Duff & Phelps' financial analyses.

Discounted Cash Flow Analysis

The Discounted Cash Flow (“DCF”) Analysis, approach is a valuation technique that provides an estimation of the value of a business based on the cash flows that a business can be expected to generate (the “DCF Analysis”). The DCF Analysis begins with an estimation of the annual cash flows the subject business is expected to generate over a discrete projection period. The estimated cash flows for each of the years in the discrete projection period are then converted to their present value equivalents using a rate of return appropriate for the risk of achieving the projected cash flows. The present value of the estimated cash flows are then added to the present value equivalent of the residual/terminal value of the business at the end of the discrete projection period to arrive at an estimate of value.

Duff & Phelps performed a DCF Analysis of the estimated future unlevered free cash flows attributable to the Combined Company for the years ending December 31, 2022 through December 31, 2024, with “unlevered free cash flow” defined as cash that is available either to reinvest or to distribute to security holders. In applying the DCF Analysis, Duff & Phelps relied on the Financial Projections. Duff & Phelps estimated the net present value of all unlevered free cash flows for the Combined Company after fiscal year 2024 (the “Terminal Values”) by applying an EBITDA multiple range to the Combined Company's projected 2024 EBITDA in the Financial Projections. Duff & Phelps discounted the unlevered free cash flows in the discrete period and the Terminal Values in 2024 back to the present to obtain a range of the estimated current enterprise value of the Combined Company.

Market Approach

The “Market Approach” is a valuation technique that provides an estimation of value by applying a valuation multiple to a specific financial metric for the subject company. These valuation multiples are either observed or derived from (i) market prices of actively traded, public companies, publicly available historical financial information and consensus equity research analyst estimates of future financial performance or (ii) prices paid in actual mergers, acquisitions or other transactions. The valuation process includes, but is not limited to, a comparison of various quantitative and qualitative factors between the subject business and other similar businesses.

Duff & Phelps utilized the Market Approach to (i) select a range of last twelve month (“LTM”) EBITDA multiples to calculate the Terminal Values for the DCF Analysis and (ii) select a range of 2024 revenue multiples to estimate a range of current enterprise value-to-projected 2024 revenue for the Combined Company.

Duff & Phelps selected two groups of companies that it deemed relevant in its analysis:

- Selected Publicly Traded Robotics and Industrial Automation Companies. Duff & Phelps used this group of eleven publicly traded companies to select a range of LTM EBITDA multiples to apply to the Combined Company's projected EBITDA in 2024. The resulting Terminal Values were used in Duff & Phelps' DCF Analysis.
- Selected Publicly Traded De-SPAC Robotics-as-a-Service (“RaaS”) Companies. Duff & Phelps selected two companies with businesses involved in the RaaS sector that have recently become publicly traded through completion of a de-SPAC transaction. Duff & Phelps used this group of companies to select a range of 2024 revenue multiples to apply to the Combined Company's projected revenue in 2024. The resulting values were an indication of the current enterprise value of the Combined Company.

[Table of Contents](#)

Duff & Phelps selected the public companies based on their relative similarity, primarily in terms of revenue growth history and outlook, capital requirements, profit margins and other characteristics, to that of the Combined Company. Duff & Phelps noted that the public companies that it selected for purpose of its analysis were not directly comparable to the Combined Company. Duff & Phelps does not have access to non-public information of any of the companies used for comparative purposes. Accordingly, a complete valuation analysis of the Combined Company cannot rely solely upon a quantitative review of the selected public companies but involves complex considerations and judgments concerning differences in financial and operating characteristics of such companies, as well as other factors that could affect their value relative to that of the Combined Company. Therefore, the selected public companies analysis is subject to certain limitations.

The tables below summarize certain observed historical and projected financial performance and trading multiples of the selected public companies. The estimates for 2022, 2023 and 2024 in the tables below with respect to the selected public companies were derived based on information for the 12-month periods ending closest to CLAQ's fiscal year ends for which information was available.

Selected Publicly Traded Robotics and Industrial Automation Companies

	LTM Revenue Growth	LTM EBITDA Growth	LTM EBITDA Margin	LTM EBITDA – CapX Margin	EV/LTM EBITDA
ABB Ltd	10.8%	53.3%	17.1%	14.3%	13.7x
Accuray Incorporated	15.9%	(38.6)%	4.8%	4.0%	17.1x
AeroVironment, Inc.	5.2%	NM	NM	NM	NM
AMETEK, Inc.	22.2%	21.1%	28.7%	26.7%	21.0x
Cognex Corporation	27.9%	44.2%	32.3%	30.8%	35.7x
Fanuc Corporation	44.1%	77.4%	32.4%	29.4%	14.4x
Hexagon AB (publ)	15.3%	23.6%	38.1%	35.6%	22.4x
Intuitive Surgical, Inc.	31.0%	56.2%	37.9%	31.7%	45.0x
Keyence Corporation	36.6%	49.1%	56.4%	55.8%	28.7x
Rockwell Automation, Inc.	17.4%	18.2%	20.3%	18.5%	23.4x
Teledyne Technologies Incorporated	49.5%	64.3%	22.4%	20.2%	24.5x

Selected Publicly Traded De-SPAC Robotics-as-a-Service (“RaaS”) Companies

	2024 Revenue Growth	2021 – 2024 Revenue CAGR	EV/2024 Revenue
Berkshire Grey, Inc.	132.5%	114.1%	1.80x
Sarcos Technology and Robotics Corp.	266.6%	194.3%	6.44x

LTM = Latest Twelve Months

EBITDA: Earnings Before Interest, Taxes, Depreciation and Amortization

EV: Enterprise Value = Market capitalization plus debt, net of cash and equivalents

CAGR: Compounded Annual Growth Rate

Sources: S&P Capital IQ, SEC Filings, Annual and Interim Reports, Investor Presentations

Summary Financial Analyses

Discounted Cash Flow Analysis

Based on the data shown in the tables above, Duff & Phelps selected a range of multiples to apply to the Combined Company's projected 2024 EBITDA to obtain a range of Terminal Values to incorporate in to the DCF Analysis. In particular, Duff & Phelps analyzed LTM revenue growth, LTM EBITDA growth, LTM EBITDA margins, LTM EBITDA less capital expenditures margins, and multiples of enterprise value -to-LTM EBITDA for the Selected Publicly Traded Robotics and Industrial Automation Companies compared to projected 2024 revenue growth, projected 2024 EBITDA growth, projected 2024 EBITDA margin, and projected 2024 EBITDA less capital

Table of Contents

expenditures margin for the Combined Company, based on the Financial Projections. Such analysis informed the selection of terminal multiples of projected 2024 EBITDA for the Combined Company. Rather than applying the average or median multiple from these analyses, Duff & Phelps selected multiples that, in its judgement, reflected the Combined Company's size, revenue growth outlook, capital requirements, profit margins, stage of product pipeline and other characteristics relative to the selected public companies. Based on these analyses, Duff & Phelps' selected a terminal EBITDA multiple range of 14.0x to 16.0x the Combined Company's projected 2024 EBITDA which resulting terminal value range was utilized in the DCF Analysis to estimate the current enterprise value range of the Combined Company.

Determination of an appropriate discount rate to use in the DCF Analysis requires a degree of judgment. Duff & Phelps considered a number of factors in determining the discount rate range, including the results of published studies on discount rates. Duff & Phelps also considered (i) the Combined Company's stage in the cycle of management's business plan, (ii) the Combined Company's projected financial performance and growth and (iii) the risks facing the Combined Company in order to achieve the projected results, including execution risk and competitive risks, among others. Based on these factors and the published discount rate studies, Duff & Phelps used discount rates ranging from 35.0% to 40.0% to discount the projected unlevered free cash flows and the Terminal Values. Duff & Phelps believes that this range of discount rates is consistent with the rate of return that security holders could expect to realize on alternative investment opportunities with similar risk profiles.

Based on these assumptions, Duff & Phelps' DCF Analysis resulted in an estimated enterprise value range for the Combined Company of \$550 million to \$710 million. Duff & Phelps further estimated the range of total equity value of the Combined Company following the Business Combination by adding pro forma cash and cash equivalents of \$225 million (which assumes no redemptions), subtracting the face value of the convertible notes of \$38 million, subtracting the Duff & Phelps' estimated theoretical value range of the Earnout Shares of approximately \$59 million to \$82 million and subtracting Duff & Phelps' estimated value range of CLAQ's warrants of \$47 million to \$65 million. Duff & Phelps estimated the values ranges for the Earnout Shares and CLAQ's warrants with a stock price simulation model using volatility inputs derived from public companies. This resulted in an estimated total equity value range for the combined company of \$631 million to \$751 million.

Market Approach

Based on the data shown in the tables above, Duff & Phelps also selected a range of valuation multiples to apply to the Combined Company's projected 2024 revenue to obtain a range of current enterprise values for the Combined Company using the Market Approach. Duff & Phelps analyzed 2024 revenue growth and 2021 through 2024 compound annual revenue growth for the Selected Publicly Traded De-SPAC RaaS Companies and compared these metrics to projected 2024 revenue growth and 2021 through 2024 compound annual revenue growth for the Combined Company, based on the Financial Projections. Duff & Phelps used these comparisons and the implied multiples of enterprise value-to-2024 projected revenue for the Selected Publicly Traded De-SPAC RaaS Companies to select a 2024 revenue multiple range of 2.5x to 3.0x to apply to the Combined Company's projected 2024 revenue, resulting in an estimated current enterprise value range for the Combined Company. Rather than applying the average or median multiple from these analyses, Duff & Phelps selected multiples that, in its judgement, reflected the Combined Company's revenue growth outlook, capital requirements, profit margins, stage of product pipeline and other characteristics relative to the Selected Publicly Traded De-SPAC RaaS Companies.

Duff & Phelps' Market Approach resulted in an estimated enterprise value range for the Combined Company of \$505 million to \$605 million. Duff & Phelps further estimated the range of total equity value of the Combined Company following the Business Combination by adding pro forma cash and cash equivalents of \$225 million (which assumes no redemptions), subtracting the face value of the convertible notes of \$38 million, subtracting the Duff & Phelps' estimated theoretical value range of the Earnout Shares of approximately \$53 million to \$67 million and subtracting Duff & Phelps' estimated value range of CLAQ's warrants of \$43 million to \$53 million (using identical methodologies as described in the DCF Analysis summary above). This resulted in an estimated total equity value range for the Combined Company of \$597 million to \$673 million.

Conclusion

Based on Duff & Phelps' analyses, Duff & Phelps noted that the equity value ranges for the Combined Company derived from each of the DCF Analysis and the Market Approach exceeds the equity value of \$560 million for the Combined Company implied by using an assumed a value of \$10.00 per share for CLAQ's Common Stock, with such

[Table of Contents](#)

\$10.00 value being based on CLAQ's initial public offering and CLAQ's approximate cash per outstanding share of CLAQ Common Stock (excluding, for the avoidance of doubt, the dilutive impact of founder shares or any Public Warrants, Private Warrants or Rights).

The Opinion was only one of the many factors considered by the Board of CLAQ in its evaluation of the Business Combination and should not be viewed as determinative of the views of the CLAQ Board.

Fees and Expenses

As compensation for Duff & Phelps' services in connection with the rendering of the Opinion to the CLAQ Board, CLAQ agreed to pay Duff & Phelps a fee of \$300,000. A portion of the fee was payable upon delivery of the Opinion and a portion is payable upon consummation of the Business Combination.

No portion of Duff & Phelps' fee is refundable or contingent upon the conclusion reached in the Opinion.

Furthermore, Duff & Phelps is entitled to be paid additional fees at a percentage of Duff & Phelps' standard hourly rates for any time incurred should Duff & Phelps be called upon to support its findings subsequent to the delivery of its opinion. CLAQ has also agreed to reimburse Duff & Phelps for its reasonable out-of-pocket expenses and reasonable fees and expenses of outside counsel retained by Duff & Phelps in connection with the engagement. CLAQ has also agreed to indemnify Duff & Phelps for certain liabilities arising out of its engagement.

The terms of the fee arrangements with Duff & Phelps, which CLAQ believes are customary in transactions of this nature, were negotiated at arm's length, and the CLAQ Board is aware of these fee arrangements.

Disclosure of Prior Relationships

During the two years preceding the date of the Opinion, Duff & Phelps has not had any material relationship with any party to the Business Combination for which compensation has been received or is intended to be received, nor is any such material relationship or related compensation mutually understood to be contemplated.

Certain Related Agreements

Support Agreements. In connection with the execution of the Merger Agreement, CleanTech Sponsor I LLC and CleanTech Investments, LLC (each, a "Sponsor," and collectively, the "Co-Sponsors") entered into a support agreement (the "Sponsor Support Agreement") with Nauticus pursuant to which the Sponsors have agreed to vote all shares of CleanTech Common Stock beneficially owned by them in favor of the Merger.

In addition, in connection with the execution of the Merger Agreement, certain stockholders of Nauticus owning approximately 88.8% of the voting power of Nauticus entered into a support agreement (the "Nauticus Support Agreement") with CleanTech and Nauticus pursuant to which the stockholders agreed to vote all shares of Nauticus beneficially owned by them in favor of the Merger.

Subscription Agreements. In connection with the execution of the Merger Agreement, CleanTech entered into subscription agreements (collectively, the "Subscription Agreements") with certain parties subscribing for shares of CleanTech Common Stock pursuant to which these investors have agreed to purchase, and CleanTech has agreed to sell to them, an aggregate of 3,530,000 shares of CleanTech Common Stock, for a purchase price of \$10.00 per share and an aggregate purchase price of \$35.3 million (the "Equity Financing"). The obligations to consummate the transactions contemplated by the Subscription Agreements are conditioned upon, among other things, customary closing conditions and the consummation of the transactions contemplated by the Merger Agreement.

Securities Purchase Agreement. In connection with the execution of the Merger Agreement, CleanTech and Nauticus entered into Securities Purchase Agreement with certain investors purchasing up to an aggregate of \$40.0 million in principal amount of the Debentures and warrants. The number of shares of common stock into which the Debentures are convertible is equal to 120% of the outstanding principal amount of the Debentures divided by the conversion price of \$15.00, and the number of shares of common stock into which the associated warrants are exercisable is equal to 120% of the outstanding principal amount of the Debentures divided by the conversion price, with an exercise price equal to \$20, subject to adjustment. The exercise price of the associated warrant will be subject to (i) customary anti-dilution adjustments; and (ii) in the case of a subsequent equity sale at a per share price below the exercise price, the exercise price of the associated warrant will be adjusted to such

lower price, and the number of shares underlying the warrant will increase proportionately. In the event of a rights offering or dividend, the warrant holder will be treated as though the shares underlying the warrant he/she holds were outstanding. These warrants can be exercised on a cashless basis. There will be an original issue discount of 2% from the issued amount of the Debentures. Interest will accrue on all outstanding principal amount of the Debentures at 5% per annum, payable quarterly. The Debentures will be secured by first priority interests, and liens on, all present and after-acquired assets of the Combined Company, and will mature on the fourth anniversary of the date of issuance. As of the date of this proxy statement/prospectus, ATW is the only purchaser and has subscribed for Debentures in the aggregate principal amount of \$37,959,184 (out of the aggregate \$40.0 million) which is convertible into 3,036,735 shares of the Combined Company's common stock and associated warrants for an additional 3,036,735 shares of the Combined Company. ATW is managed by ATW Partners Opportunities Management, LLC, which is an affiliate of Chardan, and our director, Mr. Jonas Grossman, is the Managing Partner and President of Chardan. Chardan will not receive any fees or compensation for ATW's participation in the Debt Financing. The obligations to consummate the transactions contemplated by the Securities Purchase Agreement are conditioned upon, among other things, (i) raising \$25,000,000 in equity financing from strategic investors, (ii) hiring a chief financial officer with public company experience, and (iii) all conditions precedent to the Merger set forth in the Merger Agreement having been satisfied or waived. The Equity Financing will satisfy the closing condition related to the equity financing requirement for the Debt Financing, and the PIPE Investment alone will satisfy the Minimum Cash Condition under the Merger Agreement. Mr. Rangan Padmanabhan, Nauticus' current CFO will be the CFO of the Company effective as of the date of the merger, satisfying the closing condition related to the hiring of a CFO with public company experience requirement for the Debt Financing.

Amended and Restated Registration Rights Agreement. In connection with the Closing, Nauticus, CleanTech and certain stockholders of each of Nauticus and CleanTech who will receive shares of CleanTech Common Stock pursuant to the Merger Agreement, will enter into an amended and restated registration rights agreement ("Registration Rights Agreement") mutually agreeable to CleanTech and Nauticus, which will become effective upon the consummation of the Merger.

Lock-up Agreement and Arrangements. In connection with the Closing, the Sponsors and certain Nauticus stockholders will enter into a lock-up agreement (the "Sponsor Lock-Up Agreement" and "Company Stockholder Lock-up Agreement") with Nauticus and CleanTech, pursuant to which each will agree, subject to certain customary exceptions, not to:

- (i) offer, sell, contract to sell, pledge or otherwise dispose of, directly or indirectly, any shares of CleanTech Common Stock received as merger consideration and held by it immediately after the Effective Time (the "Lock-Up Shares"), or enter into a transaction that would have the same effect;
- (ii) enter into transaction that would have the same effect, or enter into any swap, hedge or other arrangement that transfers, in whole or in part, any of the economic consequences of ownership of any of such shares, whether any of these transactions are to be settled by delivery of such shares, in cash or otherwise; or
- (iii) publicly disclose the intention to make any offer, sale, pledge or disposition, or to enter into any transaction, swap, hedge or other arrangement, or engage in any "Short Sales" (as defined in the Sponsor Lock-Up Agreement and Company Stockholder Lock-up Agreement) with respect to any security of CleanTech;

during a "Lock-Up Period" under their respective agreements.

Under the Sponsor Lock-up Agreement, the Lock-Up period means the period commencing on the Closing Date and ending on the earlier of (x) the one year anniversary of the Closing Date; (y) the date on which the volume weighted average price of shares of common stock equals or exceeds \$13.00 per share for twenty (20) of any thirty (30) consecutive trading days commencing after the Closing on Nasdaq, and (z) the date specified in a written waiver duly executed by Nauticus; provided that the restrictions set forth in the Sponsor Lock-up Agreement do not apply to (1) transfers or distributions to such stockholder's current or former general or limited partners, managers or members, stockholders, other equity holders or direct or indirect affiliates (within the meaning of Rule 405 under the Securities Act of 1933, as amended) or to the estates of any of the foregoing; (2) transfers by bona fide gift to a member of the stockholder's immediate family or to a trust, the beneficiary of which is the stockholder or a member of the stockholder's immediate family for estate planning purposes; (3) by virtue of the laws of descent and distribution upon death of the stockholder; or (4) pursuant to a qualified domestic relations order, in each case where such transferee agrees to be bound by the terms of the Sponsor Lock-up Agreement.

Under the Company Lock-up Agreement, the Lock-Up period means the period commencing on the Closing Date and ending on the earlier of (x) the date that is 180 calendar days after the consummation of the Business Combination, (y) the date on which the volume weighted average price of shares of common stock equals or exceeds \$13.00 per share for twenty (20) of any thirty (30) consecutive trading days commencing after the Closing on Nasdaq, and (z) the date specified in a written waiver duly executed by the Sponsors and CleanTech; provided that the restrictions set forth in the Company Lock-up Agreement do not apply to (1) transfers or distributions to such stockholders current or former general or limited partners, managers or members, stockholders, other equityholders or other direct or indirect affiliates (within the meaning of Rule 405 under the Securities Act of 1933, as amended) or to the estates of any of the foregoing; (2) transfers by bona fide gift to a member of the stockholder's immediate family or to a trust, the beneficiary of which is the stockholder or a member of the stockholder's immediate family for estate planning purposes; (3) by virtue of the laws of descent and distribution upon death of the stockholder; (4) pursuant to a qualified domestic relations order, in each case where such transferee agrees to be bound by the terms of this Agreement; (5) transfers or distributions of, or other transactions involving, securities other than the Lock-up Shares (including, without limitation, securities acquired in the PIPE or in open market transactions); or (6) in the case of Angela Berka (or Reginald Berka with respect to any community, marital or similar interest he may have in the following shares), the transfer of up to 1,000,000 shares of Lock-up Shares in a privately negotiated sale to another company stockholder, who shall enter into a Lock-Up Agreement (or amend an existing Lock-Up Agreement) containing the same terms and conditions as this Agreement with respect to such shares, or the entry into any agreement with respect to such a sale entered into before, at or after the Effective Time.

Director Nomination Agreement. In connection with the Closing, CleanTech, the Sponsors and Nauticus will enter into a Director Nomination Agreement (the "Director Nomination Agreement") pursuant to which CleanTech will agree to nominate Eli Spiro, an individual designated by the Sponsors to the Board of Directors of the combined company, effective as of immediately prior to the Closing.

Director Designation Agreement. In connection with the execution of the Merger Agreement, CleanTech, Nauticus and certain Nauticus stockholders entered into a director designation agreement with Transocean, Inc. ("Transocean") to take all necessary action to cause a member designated by Transocean (the "Transocean Designee") to remain on, or otherwise be appointed to, the Board, from and after the Effective Time, as a Class III member of the Board, for an initial term expiring at the third annual meeting following the date of the Second Amended and Restated Certificate of Incorporation to be adopted in connection with the Merger.

Indemnification Agreements. In connection with the Closing, CleanTech has agreed to enter into customary indemnification agreements, in form and substance reasonably acceptable to CleanTech and Nauticus, with the individuals who will be nominated and, subject to stockholder approval, elected to CleanTech's board of directors effective as of the Closing.

Management

Effective as of the closing of the Business Combination, all of the executive officers of CLAQ immediately prior to the closing of the Business Combination shall resign and the individuals serving as executive officers of the Combined Company immediately after the closing the Business Combination will be the same individuals (in the same offices) as those of Nauticus immediately prior to the closing of the Business Combination.

See "*Directors and Executive Officers of the Combined Company after the Business Combination*" for additional information.

Background of the Business Combination

The following is a brief description of the background of the Business Combination and related negotiations.

CLAQ is a blank check company incorporated in the State of Delaware on June 18, 2020 and formed for the purpose of entering into a merger, share exchange, asset acquisition, stock purchase, recapitalization, reorganization or other similar business combination with one or more businesses or entities. In conducting a targeted search for a business combination target, as described in further detail below, CLAQ utilized its vast global network as well as the industry/sector knowledge and investing/transactional experience of its Sponsor, its management, and its board of directors. The terms of the Merger Agreement and the related ancillary documents are the result of extensive negotiations among CLAQ, Nauticus, and their respective representatives and advisors.

[Table of Contents](#)

In July 2020, prior to the closing of CLAQ's IPO, CleanTech Sponsor was issued 5,000,000 shares of founder shares for an aggregate price of \$25,000. On February 15, 2021, CLAQ effected a 1.4375-for-1 stock split of its issued and outstanding shares of common stock, resulting in an aggregate of 7,187,500 shares of common stock issued and outstanding.

On February 16, 2021, CleanTech Sponsor paid \$16,667 to CLAQ, which amount was paid to CleanTech Investments, LLC to cancel 4,791,667 of its founder shares that it previously held and immediately thereafter CLAQ issued 4,791,667 founder shares to CleanTech Sponsor. As a result, CleanTech Sponsor owns 4,791,667 founder shares and CleanTech Investments owns 2,395,833 founder shares.

On June 23, 2021, CleanTech Sponsor and CleanTech Investments forfeited for no consideration 1,916,667 founder shares and 958,333 founder shares, respectively, which CLAQ cancelled, resulting in a decrease in the total number of founder shares outstanding from 7,187,500 shares to 4,312,500 shares. As a result, CleanTech Sponsor owns 2,875,000 founder shares and CleanTech Investments owns 1,437,500 founder shares. Subsequently, CleanTech Sponsor transferred an aggregate of 280,000 founder shares to CLAQ officers, directors and certain advisors, retaining only 2,595,000 founder shares. The founder shares included an aggregate of up to 562,500 shares that were subject to forfeiture in the event the underwriters' over-allotment option was not exercised in full or in part.

On July 14, 2021, the Registration Statement on Form S-1 relating to CLAQ's IPO was declared effective by the SEC. CLAQ's units began trading on the NASDAQ Capital Market on July 15, 2021, and CLAQ filed the final prospectus for its IPO on July 16, 2021. On July 19, 2021, CLAQ completed its IPO of 15,000,000 units, at a price of \$10.00 per unit, generating gross proceeds of \$150,000,000, before underwriting discounts and expenses. On August 28, 2021, the underwriters exercised the over-allotment option to purchase an additional 2,250,000 units, generating additional gross proceeds of \$22,500,000. Each unit consists of one share of CLAQ Common Stock, one-half of a warrant, and one right. Each whole public warrant entitles the holder thereof to purchase one share of CLAQ Common Stock at a price of \$11.50 per share, subject to certain adjustments. Each right entitles the holder thereof to receive one-twentieth (1/20) of one share of common stock upon the consummation of an initial business combination.

Simultaneously with the closing of the IPO, CLAQ consummated in a private placement the sale of 4,333,333 Private Warrants at a price of \$1.00 per warrant to the CleanTech Sponsor and 2,166,667 Private Warrants to CleanTech Investments, generating total gross proceeds of \$6,500,000. In connection with the underwriters' exercise of their over-allotment option, CLAQ also consummated the sale of an additional 450,000 Private Warrants to CleanTech Sponsor and 225,000 Private Warrants at \$1.00 per Private Warrant to CleanTech Investments, generating additional gross proceeds of \$675,000. Each Private Warrant is exercisable to purchase one share of Common Stock of CLAQ at \$11.50 per share. Of the proceeds received from the consummation of the IPO and the private placement purchases by CleanTech Sponsor and CleanTech Investments, an aggregate of \$152,000,000 was held in a trust account.

Except for a portion of the interest earned on the funds held in the trust account that may be released to CLAQ to pay income taxes, none of the funds held in the trust account will be released until the earlier of the completion of its initial business combination or its failure to effect a business combination within the allotted time.

CLAQ did not select any business combination target in advance of its IPO and did not, nor did anyone on its behalf, initiate any substantive discussions, directly or indirectly, with any business combination target in advance of its IPO. Until December 16, 2021, the date the Merger Agreement was signed, CLAQ and its representatives identified and initiated contact with management teams, board members, representatives, or investors of more than 65 potential acquisition targets. Throughout this process, CLAQ leveraged the investing, industry and transaction experience of its Sponsor, its management, and members of its board of directors to screen, prioritize and diligence potential acquisition candidates. As part of its review of potential targets for CLAQ's initial business combination, CLAQ's management team corresponded with representatives of venture capital firms and financial advisors to discuss their investment portfolios and potential business combination targets in which the venture capital firms held an investment. In addition to Nauticus, CLAQ entered into non-disclosure agreements and conducted additional due diligence with respect to fifteen potential targets (the "Potential Targets").

CLAQ conducted due diligence to varying degrees on the Potential Targets, including review of the business' management, balance sheet, valuation, business model, stockholders, and historical and projected financials, in each case to the extent made available, among other diligence reviews. Following such reviews, and at various points in time, CLAQ decided to discontinue discussions with the Potential Targets other than Nauticus, for one or several

[Table of Contents](#)

reasons, including preparedness for the public markets, growth potential, total addressable market, end market focus, capital requirements, market position, defensibility of business strategy, valuation, and industry trends among other reasons. Engagement with the Potential Targets included:

- Beginning in late July after the completion of the IPO through early August 2021, Mr. Eli Spiro, the Chief Executive Officer of CLAQ held a call with management of an agritech company, a Potential Target and conducted due diligence on the Potential Target.
- Beginning in late July through early September 2021, Mr. Spiro, and Mr. Richard Fitzgerald, the Chief Financial Officer of CLAQ held virtual meetings and teleconferences with management and the representatives of an energy efficiency company, another Potential Target, conducted due diligence on it, reviewed its financial analysis and discussed a potential business combination between CLAQ and the Potential Target.
- Beginning in late July through mid-August 2021, Mr. Spiro, and CLAQ Board member, Mr. Doug Cole held virtual meetings and phone calls with management and the representatives of a battery technology company, another Potential Target, conducted due diligence on it, analyzed its financials, and discussed a potential business combination between the Company and the Potential Target.
- Beginning in late July through mid-August 2021, Messrs. Spiro, Fitzgerald, Ankur Dhanuka (the Chief Technology Officer of CLAQ), and CLAQ Board members, Messrs. Cole and Brendan Riley held a virtual meeting with management and the representatives of a charging solutions company, another Potential Target, conducted due diligence on it and discussed a potential business combination between CLAQ and the Potential Target.
- Beginning in late July through late August 2021, Messrs. Spiro, Fitzgerald, Riley, and Cole corresponded with representatives of an energy storage company, another Potential Target, conducted due diligence on it and discussed a potential business combination between CLAQ and the Potential Target.
- Beginning in late July through mid-August 2021, Messrs. Spiro, Fitzgerald, Riley, Dan Reicher (the Senior Climate Advisor of CLAQ), and a CLAQ Board member, Ms. Britt Ide held virtual meetings with management and representatives of a renewable energy company, another Potential Target, conducted due diligence on it and discussed a potential business combination between CLAQ and the Potential Target.
- Beginning in late July through mid-August 2021, Messrs. Spiro and Fitzgerald held virtual meetings with representatives of a logistics company, another Potential Target, conducted due diligence on it and discussed a potential business combination between CLAQ and the Potential Target.
- Beginning in late July through late August 2021, Messrs. Spiro and Riley corresponded with representatives of a battery technology company, another Potential Target, conducted due diligence and discussed a potential business combination between CLAQ and the Potential Target.
- Beginning at the end of July through mid-September 2021, all members of CLAQ's management team and Board held multiple virtual meetings with management, Board members and representatives of an energy solutions company, another Potential Target. Throughout this time, members of CLAQ's management team, Board and representatives conducted due diligence regarding the Potential Target, its industry and competitive dynamics, reviewed the Potential Target's financial information, met with management of the Potential Target, and discussed a potential business combination between CLAQ and the Potential Target.
- Beginning at the end of July through the end of September 2021, all members of CLAQ's management team and Board members, Ms. Ide, Messrs. Reicher and Riley held multiple virtual meetings with management and representatives of a water and wastewater treatment company, another Potential Target, conducted due diligence regarding the Potential Target, its industry and competitive dynamics, reviewed the Potential Target's financial information, and discussed a potential business combination between CLAQ and the Potential Target.

- Beginning early August through late September 2021, Messrs. Spiro, Fitzgerald, and Dhanuka held virtual meetings and corresponded with management and representatives of a clean energy technology company, another Potential Target, conducted due diligence on it, reviewed the Potential Target's financial information, and discussed a potential business combination between CLAQ and the Potential Target.
- Beginning early August through mid-August 2021, Messrs. Spiro and Buffalino held virtual meetings and corresponded with management and representatives of an alternative energy company, another Potential Target, conducted due diligence on it, and discussed a potential business combination between CLAQ and the Potential Target.
- Beginning mid-August through mid-October 2021, Messrs. Spiro and Cole held virtual meetings and corresponded with management and representatives of a sustainable resource technology company, another Potential Target, conducted due diligence on it and discussed a potential business combination between CLAQ and the Potential Target.
- Beginning late August through early September 2021, Mr. Spiro corresponded with representatives of a genomics technology company, another Potential Target, conducted due diligence on it, and reviewed the Potential Target's financial information, and discussed a potential business combination between CLAQ and the Potential Target.
- Beginning late September through mid-October 2021, Mr. Spiro, and Board members, Messrs. Cole and Najarian corresponded and had a call with representatives of a renewable energy solutions company, another Potential Target, conducted due diligence on it and reviewed the Potential Target's financial information.

Neither CleanTech Sponsor nor CleanTech Investments have other SPACs in the process of searching for a target company; however CleanTech Investments is an affiliate of Chardan, which is an affiliate of other SPAC sponsors that are currently searching for targets. Nauticus was an opportunity introduced by Mr. Rahul Jasuja, a representative of Nauticus, directly to Mr. Spiro in July 2021. Chardan did not present Nauticus to CLAQ or any other SPACs it sponsors or co-sponsors.

CleanTech Investments, a co-sponsor of CLAQ, is an affiliate of Chardan which has nearly two decades of experience in the SPAC market. Since 2003, Chardan has underwritten over 100 SPAC IPOs, advised on over 30 business combination transactions with SPACs, and has sponsored or co-sponsored 15 SPACs. Of the sponsored or co-sponsored SPACs that have closed business combination transactions over the past 10 years, including LifeSci Acquisition Corp.'s acquisition of Vincera Pharma, Inc., LifeSci Acquisition II Corp.'s business combination with Science 37, Inc., Chardan Healthcare Acquisition Corp.'s business combination with BiomX Ltd., and Chardan Healthcare Acquisition 2 Corp.'s business combination with Renovacor, Inc., the stock price of each of these post-combination companies increased 30% on average over the first 90 days after closing, but has subsequently declined. CLAQ's other co-sponsor, CleanTech Sponsor, does not have any track record in the SPAC market.

Discussions and Negotiations with Nauticus

The following is a brief description of the background of the negotiations between CLAQ and Nauticus and summarizes the key meetings and events that led to the signing of the Merger Agreement. The following chronology does not purport to catalogue every conversation among the parties to the Merger Agreement or their representatives.

During the Summer of 2021, Nauticus management had introductory discussions with several SPACs, which did not include CLAQ. On June 14, 2021, Nauticus engaged Winston & Strawn LLP ("W&S") as legal counsel to assist with evaluating various opportunities for a business combination with a SPAC. In July of 2021, Nauticus and its advisors held initial conversations with CLAQ as a potential counterparty to a transaction.

On July 19, 2021, Mr. Rahul Jasuja, a representative of Nauticus, reached out to Mr. Eli Spiro, the Chief Executive Officer of CLAQ, and introduced Nauticus. On July 26, 2021, Mr. Jasuja provided introductory materials to both Mr. Spiro and Mr. Ankur Dhanuka, the Chief Technology Officer of CLAQ.

On August 5, 2021, Mr. Nicolaus Radford, who is the Founder, Chairman, President and Chief Executive Officer of Nauticus, and a representative of Nauticus provided a virtual management presentation to Mr. Spiro, Mr. Dhanuka, and a representative of CLAQ.

[Table of Contents](#)

On August 10, 2021, a representative of Nauticus held a call with Mr. Spiro and a representative of CLAQ to further discuss Nauticus' service and product offerings, financial information and projections, capital needs and requirements, and more information regarding the business, its customers and competitive landscape.

On August 11, 2021, a Non-Disclosure Agreement (the "NDA") was executed between Nauticus and CLAQ. Following execution of the NDA, Nauticus provided CLAQ with detailed materials describing Nauticus' business, customers, and financial projections. Later that day, Mr. Spiro provided all members of the management team and Board members, Messrs. Reicher, Cole, Riley, and Najarian, Ms. Ide, and Governor Richardson with materials describing Nauticus and its business.

On August 12, 2021, a representative of Nauticus and Mr. Radford provided a virtual management presentation to members of CLAQ's Board and management team, including Mr. Spiro, Mr. Dhanuka, Mr. Louis Buffalino, the Chief Operating Officer of CLAQ, and Mr. Richard Fitzgerald, the Chief Financial Officer of CLAQ.

On August 13, 2021, a Board meeting was held via teleconference with members of CLAQ's management team and the Board namely, Messrs. Spiro, Buffalino, Fitzgerald, Cole, Riley and Reicher, Ms. Ide, and Governor Richardson. The call included updates on discussions with Nauticus and other Potential Targets. Following discussions, the Board determined that it was interested in a few Potential Targets, including Nauticus.

On August 17, 2021, an in-person meeting was held with management of Nauticus and CLAQ including Mr. Radford, Mr. Fitzgerald and Mr. Spiro. Attendance also occurred virtually including, representatives of both Nauticus and CLAQ, members of CLAQ's Board including Governor Richardson, Mr. Cole, and Mr. Najarian, and other members of CLAQ's management team including Mr. Buffalino and Mr. Dhanuka. The meeting included a presentation by Mr. Radford discussing the competitive landscape, business operations, different product offerings and use cases, overview of the total addressable market, current and potential customer base, capital previously raised, future cash needs, and a deep dive into the revenue model of Nauticus. On the following day, a representative of Nauticus provided Mr. Spiro with a copy of the financial model from the presentation. On that same day, Mr. Spiro provided the financial model to all members of the management team of CLAQ and its representatives.

On August 26, 2021, a Board meeting was held virtually with representatives of CLAQ, members of the Board including Mr. Reicher, Mr. Cole, Governor Richardson, Ms. Ide, Mr. Grossman, Mr. Najarian, and Mr. Riley, and all members of CLAQ's management team. The meeting included updates on Potential Targets, including Nauticus. All in attendance voiced opinions and thoughts on specific Potential Targets, and feedback was very positive regarding Nauticus.

On August 30, 2021, a virtual meeting was held with Mr. Radford and a representative of Nauticus, and a representative of CLAQ and members of CLAQ's management team including Mr. Spiro and Mr. Fitzgerald. The meeting entailed an extensive review of the capabilities of different products, services, and software of Nauticus, as well as sales, contracts, pipeline, and key relationships associated with each product and service.

On September 1, 2021, Mr. Rahul Jasuja and management of Nauticus including Mr. Radford, Mr. Reg Berka, the Co-founder and Chief Operating Officer of Nauticus, and Ms. Angela Berka, Vice President of Finance of Nauticus, provided a virtual management presentation to representatives of CLAQ and members of the management team including Mr. Spiro, Mr. Fitzgerald, and Mr. Dhanuka. At this meeting, several topics were discussed, including but not limited to, industry trends, intellectual property, software, total addressable market, and current and potential customers.

On September 9, 2021, a virtual meeting was held with representatives of both Nauticus and CLAQ and members of both management teams including Mr. Radford, Mr. Berka, Ms. Berka, Mr. Spiro, Mr. Dhanuka, Mr. Fitzgerald and Mr. Buffalino. The meeting was held to begin discussions regarding the process for due diligence and a potential PIPE investment.

On September 15, 2021, Mr. Spiro notified all the members of CLAQ's management team, representatives and counsel that CLAQ was close to signing a letter of intent with Nauticus ("LOI"), and that they would soon receive access to a virtual Data Room with due diligence materials. On the next day CLAQ received access to the Data Room.

[Table of Contents](#)

On September 17, 2021, CLAQ and Nauticus signed a non-binding letter of intent, which included, among other terms, a pre-money valuation of \$300 million, and earnout of 7,500,000 shares of Common Stock if certain performance milestones based on revenue and EBITDA are reached over the next three years. Nauticus also agreed to negotiate exclusively with CLAQ for a period of 37 days following the execution of the non-binding term sheet, and CLAQ agreed not to enter into any letter of intent, term sheet or definitive agreement regarding an initial business combination with a potential counterparty other than Nauticus during the 37-day period. Later that day, Mr. Spiro notified all members of CLAQ's management team, and all Board members and representatives of the non-binding confidential letter of intent.

Throughout the months of September, October and November 2021, CLAQ, Nauticus, and their respective advisors, representatives and counsel participated in a number of telephone calls, virtual meetings, in person meetings, on-site visits, and email correspondence to discuss the transaction process, transaction documents and Nauticus' financial model and performance, and due diligence telephone calls, and also exchanged due diligence materials, including in the areas of legal, financial and accounting, market, information technology, software, tax, insurance, employee benefits, insurance and industry trends. In late September 2021, members of Nauticus, CLAQ management, including Messrs. Spiro and Buffalino and their respective advisors and representatives, participated in additional management meetings and telephone calls with certain of Nauticus' existing and prospective customers.

On September 19, 2021, Nauticus was provided with an initial diligence request list by the Sponsor. Following that date, additional diligence requests were submitted to Nauticus by the Sponsor and its advisors.

From September 24, 2021, through October 1, 2021, virtual meetings were held with all members of the management team of CLAQ and its representatives, members of the management team of Nauticus and its representatives, Loeb & Loeb LLP ("Loeb"), counsel to CLAQ, and W&S, counsel to Nauticus. At those meetings several discussions were held regarding topics including, positive feedback from customer calls, diligence progress and outstanding diligence requests, preparation for a PIPE presentation, and discussions regarding what should be accomplished when management of CLAQ performs an on-site diligence visit at headquarters of Nauticus.

On October 2, 2021, Mr. Spiro notified all members of the management team, all Board members and representatives that CLAQ was progressing with diligence and that the management team would be conducting an on-site diligence visit at headquarters of Nauticus. On that same day, Mr. Spiro provided the entire management team of CLAQ with correspondence between counsel of Nauticus and counsel of CLAQ that included an updated legal due diligence checklist.

On October 5, and October 6, 2021, all members of the management team of CLAQ and its representatives conducted an on-site diligence visit at Nauticus' headquarters.

On October 11, 2021, a virtual Board meeting was held, including all members of CLAQ's management team, its Board members including Governor Richardson, Mr. Cole, Ms. Ide, Mr. Reicher, Mr. Riley, Mr. Grossman, and Mr. Najarian, and representatives. During this meeting, management of CLAQ provided a high-level overview of diligence, including but not limited to, technology, intellectual property, strategy, and financials. All members of the management team expressed an overwhelmingly positive experience during their on-site visit and how impressed they were with the capabilities and experience of the entire management team of Nauticus. At the end of the meeting a unanimous vote was taken in favor of pursuing a business combination with Nauticus.

On October 12, 2021, W&S sent Loeb an initial draft of the Merger Agreement. On October 19, 2021, Loeb sent W&S initial comments to the Merger Agreement. On October 25, 2021, W&S sent Loeb a second draft of the Merger Agreement. On October 27, 2021, W&S, Mr. Rahul Jasuja and Mr. Radford visited Loeb's offices in New York, NY to meet with Loeb and Mr. Spiro to negotiate certain aspects of the Merger Agreement, including the earnout conditions. Mr. Radford proposed earnout to be tied to stock price performance instead of operating performance which can be hard to measure. He also proposed that the earnout shares be released within a shorter time period. Parties finally agreed to an earnout structure whereby 7,500,000 shares of Common Stock will be released from escrow upon achievement of certain stock price thresholds over a five-year period. On November 3, 2021, Loeb sent W&S further comments to the Merger Agreement. On November 11, 2021, W&S sent Loeb a third draft of the Merger Agreement. On November 29, 2021, Loeb sent W&S further comments to the Merger Agreement. On November 29, 2021, W&S sent Loeb a fourth draft of the Merger Agreement. On December 2, 2021, Loeb sent W&S further comments to the Merger Agreement.

[Table of Contents](#)

On December 11, 2021, W&S sent Loeb a fifth draft of the Merger Agreement. On December 14, 2021, W&S sent Loeb a sixth draft of the Merger Agreement. On December 15, 2021, Loeb sent W&S further comments to the Merger Agreement and W&S agreed that the Merger Agreement was in final form.

On October 14, 2021, a virtual meeting was held to discuss a PIPE presentation for potential investors. Attendance at this meeting included representatives of both Nauticus and CLAQ, Mr. Radford, and Mr. Spiro. On October 18, 2021, representatives of both Nauticus and CLAQ, Mr. Radford, and Mr. Spiro held a virtual meeting to present a dry run of the PIPE presentation.

On October 15, 2021, a LOI extending the exclusivity period to November 17, 2021, was signed by both Nauticus and CLAQ. As part of the agreement, CLAQ and Nauticus agreed to not, directly or indirectly make or solicit offers, inquiries or proposals to, or consider proposals from, negotiate with or participate in discussions with, or disclose any information to, any other parties.

From October 19, 2021, through October 22, 2021, various virtual meetings were held with different investment banks to introduce the business of Nauticus and CLAQ, the proposed transaction, PIPE needs and timeline. Attendance at all these meetings included representatives of both Nauticus and CLAQ, Mr. Radford, and Mr. Spiro.

On October 20, 2021, Mr. Spiro notified all members of CLAQ's management team, all Board members and representatives that Nauticus, known as "Houston Mechatronics Inc." at the time was in the process of changing its name to "Nauticus Robotics, Inc." In addition, Mr. Spiro provided those individuals with updates including the fact that CLAQ is almost finished with due diligence with no material issues at the moment, CLAQ recently sent back comments on Merger Agreement and will continue to negotiate over the next few weeks, and an exclusivity period under the LOI had been extended until November 17, 2021.

On October 26, 2021, an in-person meeting was held at the offices of ATW with Mr. Radford, Mr. Spiro, executives of ATW, and their respective representatives. ATW is managed by ATW Partners Opportunities Management, LLC, which is an affiliate of Chardan Capital Markets, LLC ("Chardan"). CleanTech Investments is an affiliate of Chardan, and CLAQ's director, Mr. Jonas Grossman, is the Managing Partner and President of Chardan. At that meeting a potential convertible debt PIPE security was discussed. On November 2, 2021, a term sheet was received for the convertible debt PIPE security. From November 2 through November 9, 2021, negotiations were conducted in regard to the convertible debt PIPE security. On November 9, 2021, all parties agreed to the term sheet and it was signed. On November 17, 2021, in-person diligence was performed at the headquarters of Nauticus. Attendance for the in-person diligence included executives of Nauticus and ATW, and Mr. Spiro. From November 17, 2021 until the signing of the Securities Purchase Agreement on December 16, 2021 in connection with the Debt Financing, negotiations were held in regard to the potential convertible debt investment via multiple phone calls, virtual meetings, as well as follow up diligence. Participants included executives and representatives of Nauticus and ATW and Mr. Spiro. As part of its due diligence investigations, ATW also retained third party advisors with specialties in industrial manufacturing and business scalability assessment to validate and assess the business. Messrs. Spiro, Fitzgerald and Buffalino were given a summary of the results of ATW's due diligence. While the due diligence results were generally very positive, they also revealed some potential production risks in that Nauticus lacks the necessary supplies and components in-house to manufacture the products in large quantities. Nauticus took this concern seriously and identified a third-party manufacturing firm who can help mitigate the production risk. CLAQ was both satisfied with, and impressed by, Nauticus' prompt response to address the concern.

On October 27, 2021, members of the management team of both CLAQ and Nauticus including Mr. Spiro and Mr. Radford, and their respective representatives and counsel, all met in-person at the offices of Loeb in order to discuss remaining open business issues of a potential business combination transaction.

From late October through December 15, 2021, CLAQ, Nauticus, and their respective representatives began contacting a limited number of potential PIPE Investors, each of whom agreed to maintain the confidentiality of the information received pursuant to customary "wall cross" non-disclosure agreements, to discuss Nauticus, the proposed business combination and the PIPE Investment and to determine such investors' potential interest in participating in the PIPE Investment. Beginning on October 29, 2021, and until the signing of the Merger Agreement on December 16, 2021, representatives and management of both Nauticus, and CLAQ including Messrs. Spiro, Fitzgerald and Buffalino, participated in various virtual meetings, phone calls, and correspondence with prospective participants in the PIPE Investment.

[Table of Contents](#)

On November 14, 2021, both Nauticus and CLAQ agreed to extend the exclusivity period under the LOI to December 17, 2021.

On December 1, 2021, a virtual Board meeting was held, including all members of CLAQ's management team and representatives, and Board members including Mr. Weiss, Ms. Ide, Mr. Riley, Governor Richardson, Mr. Reichler, and Mr. Grossman. During this meeting, management of CLAQ provided an update regarding several items including, Nauticus' development of new units and contracts, the merger agreement and its terms, earn out structure, restricted shares and lockup period, targeted announcement date, and the expected process following a merger announcement. The management team also updated the Board regarding a potential PIPE with strategic partners and existing investors, as well as a potential convertible debt PIPE security which later became the Debt Financing. One of the Board members suggested an introduction to an individual that is highly regarded in the offshore wind market. The management team expressed interest in a "wall-cross" process with that individual in order to speak with him in detail to see how they could collaborate.

On December 10, 2021, a virtual Board meeting was held, including all members of CLAQ's management team, Board members including Governor Richardson, Ms. Ide, Mr. Riley, Mr. Cole, and Mr. Grossman, representatives and counsel. At that meeting, the Board approved documentation for the business combination. The Board did not obtain a third-party valuation or fairness opinion in connection with its resolution to approve the Merger but determined that CLAQ's management, CleanTech Sponsors and the members of the Board had substantial experience in evaluating the operating, financial and business merits of companies similar to Nauticus, sufficient to make its own determination of the merits of a business combination with Nauticus. On January 28, 2022, in order to provide added transparency to the transactions contemplated by the Merger Agreement and greater certainty to close the Business Transaction in the current turbulent market, CLAQ retained Duff & Phelps to serve as an independent financial advisor to the Board of CLAQ, specifically to provide to the Board a fairness opinion in connection with the Business Combination. The CLAQ Board obtained a fairness opinion from Duff & Phelps on March 24, 2022.

On December 14, 2021, CLAQ and Chardan entered into a Financial Advisory Agreement pursuant to which Chardan, acting as CLAQ's exclusive financial advisor and exclusive placement agent of any private placement of securities in connection with the business combination, will be paid a placement fee of 6.0% of the aggregate gross proceeds received from the PIPE Investment that is not sold to an affiliate of Chardan, at Closing. As the sole placement agent for the PIPE Investment, Chardan performed customary PIPE due diligence on Nauticus including site visits, customer calls and financial analysis. Pursuant to the Financial Advisor Agreement, Chardan also has a right of first refusal to act as a book-running manager with minimum economics of 15% for the first two public or private equity offerings by CLAQ or any successor or subsidiary of CLAQ.

On or about December 14, 2021, Equity Financing investors executed and delivered the Subscription Agreements, which provided for binding subscriptions to purchase an aggregate of 3,530,000 shares of CLAQ Common Stock at \$10.00 per share. On December 16, 2021, the transaction was finally approved and, the parties entered into the Merger Agreement and the related ancillary documents. On that same day, ATW entered into the Securities Purchase Agreement with CLAQ and Nauticus subscribing for Debentures in the aggregate principal amount of \$37,959,184 (out of the aggregate \$40.0 million) which is convertible into 3,036,735 shares of the Combined Company's common stock and associated warrants for an additional 3,036,735 shares of the Combined Company. The following morning, CLAQ and Nauticus issued a joint press release announcing the execution and delivery of the Merger Agreement, and CLAQ filed a Current Report on Form 8-K, which included as exhibits (a) the joint press release, dated December 17, 2021, (b) an investor presentation providing information on Nauticus' business and a summary of certain key terms of the business combination, (c) a transcript of a conference call with investors, (d) the Merger Agreement and certain related ancillary documents, and (e) certain other communications. After the Merger Agreement was signed on December 16, 2021 and before March 31, 2022, Nauticus asked if Mr. Spiro would be interested in joining the Combined Company's board. On or about June 1, 2022, CLAQ Co-Sponsors named Mr. Spiro as their designated director nominee for the Combined Company under the Director Nomination Agreement, and Mr. Spiro accepted the nomination on that same day.

In order to broaden CLAQ and Nauticus' reach to additional potential investors, parties interviewed a number of investment banks. After having considered the relative strengths and customer bases of different investment banks and advisory services providers, parties entered into letter agreements with four investment banks for their capital markets and financial advisory services between February and April 2022. None of these four investment banks are affiliated with CLAQ, its officers and directors or any of their affiliates. Pursuant to a letter agreement dated February 11, 2022 with Roth Capital Partners, LLC ("Roth"), CLAQ has agreed to pay Roth a cash advisory fee of \$350,000 following the closing of the Business Combination during the term of the agreement or within six months

following any termination of the agreement, in return for Roth’s capital markets advisory services which include, among other things, (i) providing advice and assistance to CLAQ regarding defining objectives and potential equity offerings (including with respect to structure, marketing strategy and execution); (ii) assisting the evaluation of CLAQ’s equity securities; and (iii) performing analyses of equity capital markets and shareholder engagement. The term of the agreement with Roth shall continue until terminated by either party. Pursuant to a letter agreement dated February 28, 2022 with Lake Street Capital Markets (“Lake Street”), CLAQ and Nauticus have agreed that the Combined Company will pay Lake Street a non-refundable retainer of \$350,000 within ten days following the closing of the Business Combination in return for Lake Street’s capital markets advisory services which include, among other things, (i) providing advice and assistance to CLAQ in evaluating its capital raising strategies and alternatives; (ii) assisting CLAQ in refining and communicating its investor presentation; and (iii) working and coordinating with CLAQ’s investors relations resources to conduct a non-deal investor roadshow in the U.S. and solicit, and analyze investors’ feedback. The term of the agreement with Lake Street shall expire on the earlier of (a) February 28, 2023, or (b) the closing of the Business Combination. Pursuant to a letter agreement dated March 23, 2022 with Cowen and Company, LLC (“Cowen”), Nauticus has agreed to pay Cowen an advisory fee of \$1,750,000 (the “Business Combination Fee”) upon closing of the Business Combination in return for Cowen’s capital market advisory services which include, among other things, (i) familiarizing itself with the business, properties and operation of each of CLAQ and Nauticus; (ii) advising Nauticus on investor outreach, assisting Nauticus in scheduling and arranging meetings with current and potential holders of its securities; and (iii) assisting Nauticus in formulating a marketing strategy for the Business Combination. If this agreement with Cowen is terminated, the Business Combination Fee will still be payable if a business combination is consummated within twelve months from the date of the termination of the agreement (the “Residual Period”). If during the term of this agreement with Cowen or the Residual Period, Nauticus proposes to effect any restructuring, acquisition or disposition, or certain sales of securities, Nauticus has agreed to engage Cowen and offer Cowen no less than 35% of the total economics for any such capital raising transaction. Pursuant to an amended and restated letter agreement dated April 25, 2022 with Coastal Equities, Inc. (“Coastal”), Nauticus has agreed to pay Coastal a cash fee of \$7,600,000 (“Cash Fee”) upon closing of the Business Combination or any other transaction defined as a “Sale” of Nauticus pursuant to the letter agreement in return for Coastal’s financial advisory services which include, among other things, (i) facilitating potential purchasers’ or financing participants’ due diligence investigation; (ii) performing valuation analyses; (iii) identifying opportunities for the Sale of Nauticus; and (iv) as requested by Nauticus, participating on Nauticus’ behalf in negotiations concerning such Sale. If this letter agreement with Coastal is terminated, the Cash Fee will still be payable if the Sale of Nauticus occurs within 9 months from March 29, 2022, the effective date of the letter agreement.

In light of the current turbulent market, Mr. Spiro, in consultation with Mr. Louis Buffalino, CLAQ’s Chief Operating Officer, and Mr. Richard Fitzgerald, CLAQ’s Chief Financial Officer, considered it necessary and in the best interests of CLAQ and its shareholders to increase the aggregate number of shares of the Combined Company’s Common Stock to be reserved for issuance under the Incentive Plan. On June 6, 2022, the Merger Agreement was amended to increase the aggregate number of shares of the Combined Company’s Common stock to be reserved for issuance pursuant to the Incentive Plan from 5% to 10% of the fully diluted outstanding shares of its Common Stock after Closing, which share reserve shall be automatically increased on an annual basis by 3% of the total number of Common Stock outstanding as provided under the Incentive Plan.

CleanTech Acquisition Corp.’s Board of Directors’ Discussion of Valuation and Reasons for the Approval of the Business Combination

CLAQ was formed for the purpose of entering into a merger, share exchange, asset acquisition, stock purchase, recapitalization, reorganization or other similar business combination with one or more businesses or entities. With respect to the proposed Business Combination, the CLAQ Board considered a number of factors as generally supporting its decision to enter into the Business Combination, including but not limited to the following factors, although not weighted or in any order of significance:

- ***Compelling Opportunity in the government, commercial and industrial technologies and robotics market.*** The CLAQ Board believes that Nauticus’ advanced robotic technologies can disrupt the current ocean services and data markets, and if Nauticus executes its plan to hire and expand its engineering & development, sales, and marketing teams to achieve its growth strategy, it can successfully expand its core products and services offerings in the maritime robotic services space.

- **Highly Disruptive Technology.** Nauticus develops revolutionary cloud-based autonomy and machine learning software to enable a smarter and more sustainable ocean industry using its growing fleet of autonomous robots from the surface to the seabed. These robots are enabled by the *ToolKITT*, the Nauticus software suite, a platform of AI/ML technologies designed to disrupt the legacy methods in the marine industry. Nauticus' first product offering, Aquanaut, is the world's first tetherless underwater robot capable of robust decision making for both long distance ocean data collection and close-in dexterous manipulation of the ocean environment, supporting government & defense and several commercial industry sectors. The CLAQ Board believes this disruptive technology provides a service that is significantly cheaper to customers than the legacy method and results in a meaningful reduction of carbon emissions.
- **Development of the new RaaS subscription model.** The CLAQ Board also believes in Nauticus' ability to further develop its RaaS subscription model (a business model planned for future commercial services but not yet implemented), an equally disruptive offering, and derive revenue from this new model from its existing and new customers.
- **Vast market opportunity for Nauticus' advanced robotic technologies.** The CLAQ Board believes that the market for Nauticus' advanced robotic technologies is vast since it covers a wide range of market segments including offshore renewables, government & defense, oil & gas, offshore data centers & telecommunications, aquaculture, subsea mining, port security & management, and oceanographic & science missions.
- **Environmental Benefits.** Nauticus' ToolKITT software, robots, and services provide customers the necessary data collection, analytics, and subsea manipulation capabilities to support and maintain assets, while significantly reducing their operational and carbon footprints to improve offshore health, safety, and environmental exposure. The legacy method can require an expensive and heavy topside infrastructure footprint, i.e. an offshore service vessel that can emit up to 70 metric tons of CO₂ per day. The CLAQ Board believes Nauticus' products and services eliminates the need for the large vessel, which results in an approximate 97% reduction in carbon emissions.
- **Backed by Strategic Partners.** Nauticus' largest investors are Transocean Ltd. (NYSE: RIG) and Schlumberger Limited (NYSE: SLB), both of which the CLAQ Board believes provide additional validation to CLAQ's assessment of Nauticus' business opportunity and technologies. They are both large players in the ocean services space and may provide future business opportunities for Nauticus. In addition, both of them have committed to participating in the PIPE Investment.
- **Experienced management team.** The CLAQ Board believes that Nauticus has a proven and experienced management team with deep operational expertise, led by Nicolaus A. Radford, its Chief Executive Officer and Reginald B. Berka, its Executive Vice President of Business Operations and former Chief Operations Officer. Mr. Radford has over 20 years of experience in the robotics industry and Mr. Berka has over 45 years of experience in engineering and management. In addition, the Nauticus team started with over twenty former NASA employees when the company started seven years ago and over fifteen of them are still at Nauticus today. The Nauticus team works exceptionally well together and their cohesiveness has fostered long term stability and may lead to tremendous growth and success over the long term. The CLAQ Board believes that Nauticus' highly seasoned and experienced management team has the strong combination of a proven track record and technology expertise required to position the combined company for success.
- **Terms of the Merger Agreement.** The CLAQ Board reviewed and considered the terms of the Merger Agreement and the other related agreements, including the parties' conditions to their respective obligations to complete the transactions contemplated therein and their ability to terminate the Merger Agreement. See “— *The Merger Agreement*” and “— *Certain Related Agreements*” for detailed discussions of the terms and conditions of these agreements.
- **Results of Due Diligence.** The CLAQ Board considered the scope of the due diligence investigation conducted by CLAQ and its outside advisors and evaluated the results thereof and information available to it related to Nauticus, including:
 - diligence regarding Nauticus' potential business opportunities in offshore renewables, government & defense, oil & gas and port security & management among others;

- commercial due diligence with Nauticus' current customers and strategic partners which included twelve calls with existing and potential customers, market experts, partners, suppliers, and investors;
- extensive meetings and calls with Nauticus' management team regarding its business, operations, projections and the proposed Business Combination;
- review of materials related to Nauticus made available, including with respect to financial statements, material contracts, key metrics and performance indicators, benefit plans, intellectual property matters, labor matters, information technology, privacy, litigation information, environmental matters, regulatory matters and other legal and business diligence matters.
- a live viewing of the Aquanaut that performed varying tasks under water, which was used to prove its commercial viability and readiness;
- as part of the transaction, ATW committed to purchase convertible notes in the principal amount of \$37,959,184 after extensive meetings with Nauticus' management both on and off site. As part of its due diligence investigations, ATW also retained third party advisors with specialties in industrial manufacturing and business scalability assessment to validate and assess the business. ATW's investment further validated CLAQ's overall assessment of Nauticus' business opportunity, technologies and services.
- **Attractive Valuation and financial forecasts.** The CLAQ Board considered the non-public, internal financial forecasts regarding Nauticus' anticipated future operations for fiscal years 2021 through 2024 that were prepared by Nauticus' management and provided to CLAQ in connection with the CLAQ Board's evaluation of the Business Combination. The Board reviewed the market capitalization, enterprise value and implied valuation multiples of its primary public company peer set, Pure-Play RaaS, and four secondary public company peer sets, Robotics & Automation, Disruptive Category Creators, All-Electric Autonomous Platforms and Energy Transition & Clean-Tech. CLAQ compared the same to the implied enterprise value of Nauticus determined in accordance with the internal valuation analysis of CLAQ management. CLAQ management found that Nauticus' equity value of approximately \$300 million implied a pro forma enterprise value of 1.9x estimated 2024 revenue and 3.4x estimated 2024 EBITDA, an attractive valuation relative to the peer set especially in light of Nauticus' strong growth and projected margin profile.

The CLAQ Board also identified and considered the following factors and risks weighing negatively against pursuing the Business Combination, although not weighted or in any order of significance:

- **Exclusivity.** The fact that the Merger Agreement includes an exclusivity provision that prohibits CLAQ from soliciting other business combination proposals, which restricts CLAQ's ability, so long as the Merger Agreement is in effect, to consider other potential business combinations.
- **New Product Risks.** The risks that Nauticus has limited experience in commercializing its core products and will be launching a new RaaS business model.
- **Benefits Not Achieved.** The risk that the potential benefits of the Business Combination may not be fully achieved, or may not be achieved within the expected timeframe.
- **Liquidation of CLAQ.** The risks and costs to CLAQ if the Business Combination is not completed, including the risk of diverting management focus and resources to other businesses combination opportunities, which could result in CLAQ being unable to effect a business combination by July 19, 2022 (unless extended) and force CLAQ to liquidate.
- **Shareholder Vote.** The risk that CLAQ's shareholders may fail to provide the respective votes necessary to effect the Business Combination.
- **Limitations of Review.** The CLAQ Board considered that they were not obtaining an opinion from any independent investment banking or valuation firm that the consideration to be received by Nauticus is fair to CLAQ or its shareholders from a financial point of view.
- **Closing Conditions.** The fact that completion of the Business Combination is conditioned on the satisfaction of certain closing conditions that are not within CLAQ's control.

- **Litigation.** The CLAQ Board considered the possibility of litigation challenging the Business Combination or that an adverse judgment granting permanent injunctive relief could enjoin consummation of the Business Combination.
- **Fees and expenses.** The CLAQ Board considered the fees and expenses associated with completing the Business Combination.
- **Production and Maintenance Risks.** Under the RaaS subscription model (a business model planned for future commercial services but not yet implemented), Nauticus will be responsible for maintenance and servicing of the units. The CLAQ Board considered that Nauticus has no experience providing maintenance and servicing at a large scale.
- **Conflicts of Interest.** The conflicts of interest highlighted in this document, including that CLAQ's Co-Sponsors have a fiduciary obligation to each of their respective members and Eli Spiro (our Chief Executive Officer and Director) and Jonas Grossman (our Director) are the controlling members of our Co-Sponsors. Because each of Mr. Spiro and Mr. Grossman have a fiduciary obligation to both CLAQ and the Co-Sponsors, they had a conflict of interest when voting on the Business Combination. CLAQ's Board considered the possibility that the conflicts could have resulted in CLAQ's management team selecting a target that was not as beneficial to the public stockholders as to the Co-Sponsors or their affiliates.
- **Other risks.** Various other risks associated with the Business Combination, the business of CLAQ and the business of Nauticus described in the section titled "*Risk Factors*."

Certain Nauticus' Projected Financial Information

Prior to the approval by the CLAQ Board of the Business Combination and the execution of the Merger Agreement and related agreements, Nauticus provided CLAQ with internally prepared forecasts for each of the years ending December 31, 2021 through 2024. Nauticus does not as a matter of course make public forecasts as to future results. The management of Nauticus prepared the prospective financial and operating information set forth below to provide to CLAQ. The accompanying prospective financial and operating information was not prepared with a view toward public disclosure or with a view toward complying with the guidelines established by the American Institute of Certified Public Accountants with respect to prospective financial information or GAAP with respect to forward-looking financial information.

Due to the forward-looking nature of these projections, specific quantifications of the amounts that would be required to reconcile such projections to GAAP measures are not available and Nauticus' management believes that it is not feasible to provide accurate forecasted non-GAAP reconciliations. In the view of Nauticus' management, this financial and operating information was prepared on a reasonable basis, reflects the best currently available estimates and judgments, and presents, to the best of management's knowledge and belief, the expected course of action and the expected future performance of Nauticus at the time. This information should not be relied upon as being necessarily indicative of future results, and readers of this proxy statement/prospectus are cautioned not to place undue reliance on the prospective information.

The inclusion of projections in this proxy statement/prospectus should not be regarded as an indication that CLAQ, the Board, or their respective affiliates, advisors or other representatives considered, or now considers, such projections necessarily to be predictive of actual future results or to support or fail to support your decision whether to vote for or against the Business Combination. The projections are not fact and should not be relied upon as being necessarily indicative of future results, and readers of this proxy statement/prospectus, including investors or shareholders, are cautioned not to place undue reliance on this information. You are cautioned not to rely on the projections in making a decision regarding the transaction, as the projections may be materially different than actual results. We will not refer back to the projections in our future periodic reports filed under the Exchange Act.

The projections reflect numerous estimates and assumptions with respect to general business, economic, regulatory, market and financial conditions and other future events, as well as matters specific to Nauticus' business, all of which are difficult to predict and subject to change and many of which are beyond Nauticus' and CLAQ's control. The projections are forward-looking statements that are inherently subject to significant uncertainties and contingencies, many of which are beyond Nauticus' control. See "*Risk Factors*," "*Nauticus Management's Discussion and Analysis of Financial Condition and Results of Operations*" and "*Cautionary Note Regarding Forward-Looking Statements*." As a result, there can be no assurance that the projected results will be realized or that actual results

[Table of Contents](#)

will not be significantly higher or lower than projected. Since the projections cover multiple years, such information by its nature becomes less reliable with each successive year. These financial projections are subjective in many respects and thus are subject to multiple interpretations and periodic revisions based on actual experience and business developments. We encourage you to review Nauticus' financial statements included in this proxy statement/prospectus as well as the section entitled "Selected Historical Consolidated Financial and Data of Nauticus," "Unaudited Pro Forma Condensed Combined and Consolidated Financial Information," and "Management's Discussion and Analysis of Financial Condition and Results of Operations of Nauticus" in this proxy statement/prospectus.

Neither CLAQ nor Nauticus' independent auditors, nor any other independent accountants, have compiled, examined, or performed any procedures with respect to the prospective financial information contained herein, nor have they expressed any opinion or any other form of assurance on such information or its achievability, and assume no responsibility for, and disclaim any association with, the prospective financial information. Nonetheless, a summary of the projections is provided in this proxy statement/prospectus because they were made available to the CLAQ Board in connection with their review of the proposed transaction.

EXCEPT TO THE EXTENT REQUIRED BY APPLICABLE FEDERAL SECURITIES LAWS, BY INCLUDING IN THIS PROXY STATEMENT/PROSPECTUS, A SUMMARY OF THE PROJECTIONS FOR NAUTICUS, NEITHER CLEANTECH NOR NAUTICUS UNDERTAKES ANY OBLIGATIONS, AND EACH EXPRESSLY DISCLAIMS ANY RESPONSIBILITY TO UPDATE OR REVISE, OR PUBLICLY DISCLOSE ANY UPDATE OR REVISION TO, THESE PROJECTIONS TO REFLECT CIRCUMSTANCES OR EVENTS, INCLUDING UNANTICIPATED EVENTS, THAT MAY HAVE OCCURRED OR THAT MAY OCCUR AFTER THE PREPARATION OF THESE PROJECTIONS.

The key elements of the projections provided to and relied upon by the Company and the Board for purposes of its financial analyses and approval, are summarized in the table below:

Projected Revenue and EBITDA (\$mm) ⁽¹⁾⁽²⁾ ³⁾	2021A	2022E	2023E	2024E
Services	8.6	13.9	57.7	146.0
Direct Product Sales	0.0	9.5	36.8	56.1
Total Revenue	8.6	23.4	94.5	202.1
EBITDA	n/a	0.3	31.0	110.8
EBITDA Margin	n/a	1%	33%	55%

- (1) The projected revenue by Services and Direct Product Sales disclosed in the table above is the same that was presented and prepared as part of the projected financial information that Nauticus provided to CLAQ prior to its approval of the Business Combination.
- (2) The services reflected in the above table includes revenue from the RaaS model (as projected) applied to commercial services (primarily subsea energy/offshore wind), engineering services (primarily the Defense market), the lease of vehicles to commercial customers, and software licenses (SaaS). The Direct Product Sales category summarizes the sales of Aquanaut and Argonaut vehicles directly to commercial and defense customers.
- (3) The RaaS model is anticipated to fully commence in late 2022 after the delivery of additional vehicles to increase the fleet size and after their respective commissioning. Since the vehicles will have limited calendar space to generate revenue in 2022, the RaaS service model is expected to account for just a small portion, approximately \$0.35 million of the \$13.9 million, in the broader Services category (as defined above) revenue for 2022. These vehicles, along with the new builds projected in 2023, are expected to generate approximately \$12.6 million of the \$57.7 million Services revenue in 2023 with the balance of the revenue coming from the other services and product sales within government markets. In 2024, the service fleet is expected to expand and the revenue from the RaaS business is estimated to account for \$117.4 million of the total projected revenue of \$146.0 million from services.

The statements and disclosures in the table above, related to the RaaS service revenue, are subject to the same qualifications and assumptions described in Footnote (1) above. Nauticus' financial projections primarily rely on two major revenue streams — the timely manufacturing and commissioning of the production of the Nauticus Fleet (the tandem pair Aquanauts and Hydronauts) put into commercial service using the RaaS model, and the adoption of the defense variants (Argonauts) realized as product sales with long operation and maintenance revenue tails both in US and foreign markets. Other ancillary revenue streams also include: limited commercial sales of Aquanaut and Hydronaut directly; Olympic arms; ToolKITT software licenses; and revenue from other sponsored programs (engineering services) sometimes performed for commercial customers, but primarily from government customers.

[Table of Contents](#)

RaaS commercial services in Nauticus’ financial model relies on the staggered production output of the Nauticus Fleet assuming increasing days on hire ramping up to a full utilization modeled as 200 days per year per tandem pair at the \$40,000 per day. Each tandem pair is predicted to drive \$8 million per year of revenue at full utilization. As for direct sales, the overall revenue projection is supplemented by the increasing market adoption of government customers from modest quantities early on to higher vehicle targets once the full acceptance of the platform is realized.

Services Revenue ⁽¹⁾⁽²⁾	2021A	2022E	2023E	2024E
Commercial Services (RaaS)	0.0	0.3	12.6	117.4
Commercial Lease	0.0	0.0	1.5	3.7
Commercial Services Contracts	0.0	0.0	1.8	2.7
Sponsored Programs	8.6	9.0	34.4	13.5
Software Licenses	0.0	4.6	7.4	8.7
Total Services	8.6	13.9	57.7	146.0

Directed Sales Revenue	2021A	2022E	2023E	2024E
Commercial Sales	0.0	9.5	28.0	29.8
Defense Sales	0.0	0.0	8.8	26.3
Total Direct Sales	0.0	9.5	36.8	56.1
Total Revenue	8.6	23.4	94.5	202.1

- (1) The table above represents the breakdown of the service and direct product sales components. The Commercial Services captures projected revenue from the Nauticus fleet performing services in oil & gas, offshore renewables, and other related markets. The Commercial Lease section projects revenue from leasing Aquanauts directly to service companies or entities that desire to operate the platform themselves for their own usage, but do not desire to own it outright — so they lease it. The Service Contracts summarize opportunities for Nauticus personnel to perform the operations using the Nauticus Fleet where the Fleet assets have been purchased by commercial customers. For a point of understanding, Service Contracts are essentially the opposite of leases, i.e. companies that desire to own the assets outright, but do not have the expertise to operate them. The Sponsored Programs section provides an estimate for expected growth in government or other commercial engineering service contracts aimed at technology development. Revenue generated from licenses for the ToolKITT software are shown under Software Licenses.
- (2) The projected outyear growth in these revenue classes is driven by the current sales pipeline and contracted commitments. The Services and Direct Product Sales forecasts are derived from multiple components that are modeled based on market intelligence gained from direct customer interactions, upselling current commercial partners, letters of intent, memorandums of understanding, high confidence verbal indications, and further extrapolations from on-contract activities derived from current customers. Since this is a new type of high technology service for the ocean markets, Nauticus has bid on and has won commercial contracts engaged in studies and pilots with large, long term potential customers around the RaaS offering that when successfully completed, will result in the uptake of Nauticus service for those respective customers. These pilots are leading indicators and market microcosms that gives Nauticus reasonable confidence when projecting how the RaaS commercial service offering will scale as the market adopts it, as indicated by the commercial fleet size as disclosed in the investor deck. Concurrently, the government markets will mature at similar rates, although purchasing the subsea vehicles outright for their use cases.

In the second quarter of 2022, Nauticus has renegotiated the milestone payment terms with Triumph Subsea Services for their Purchase Order for the Aquanaut and Hydronaut and supporting equipment (see line item for 2022 Commercial Sales). The renegotiation has resulted in a shift of the first payment from Q2 of 2022 to Q3 of 2022. See “Risk Factors” for further information.

Revenue Pipeline (\$mm)	2022E	2023E	2024E
Committed Orders	22.0	38.0	28.6
Committed LOIs/MOUs	9.0	7.5	12.9
Uncommitted Sales Pipeline	29.2	28.1	136.1
Uncommitted Commercial Services	0.0	2.0	22.1
<i>% of Total Revenue Committed</i>	<i>132%</i>	<i>48%</i>	<i>21%</i>
<i>% of Total Revenue Committed + in Sales Pipeline</i>	<i>257%</i>	<i>78%</i>	<i>88%</i>

Annual Vehicle Build Schedule	2022E	2023E	2024E
Commercial Services	2	5	18
Commercial Sales/Leases	1	2	4
Defense and Port Security	1	2	3
Total number of vehicles built during the year	4	9	25
Cumulative Commercial Services Fleet	2	7	25

CLAQ believes that Nauticus has sufficient engagement with customers in target markets to enable it to reasonably project demand through 2024. While Nauticus Robotics currently does not have any “hard commitments” (e.g., executed purchases orders for RaaS services), Nauticus has “soft commitments” and contractual expressions (e.g., letters of intent and memorandums of understanding from customers that express significant demand to use the devices once the initial fleet production is complete).

Nauticus also has purchase orders for limited direct sales with a 3^d party where Nauticus would operate the devices, although not “precisely” through our RaaS model (a business model planned for future commercial services but not yet implemented). One such example is an Aquanaut, which Nauticus currently operates under an 18-month lease arrangement for a U.S. governmental customer. This arrangement is not “precisely” through our RaaS model (a business model planned for future commercial services but not yet implemented) as the Aquanaut that is being leased is in support of another program and some of the labor costs associated with such operations is accounted for through another contract, as originally intended by the U.S. governmental customer.

The RaaS business model is based on a recurring services revenue approach, whereby customers may pay an all-inclusive rate for the completion of a desired service. Our RaaS business model charges a daily rate for the Hydronaut and Aquanaut pair to perform ocean services. The current 18-month lease contract (a copy of which is provided herein as Exhibit 10.25), which is not “precisely” through RaaS, between Nauticus and a Large Confidential Government Contractor, for the Aquanaut creates recurring monthly revenue, which is a key attribute of the RaaS business model. This contract has two components — an engineering services portion, which supports the software development and other direct costs of the program, and a lease portion that supports the use of Aquanaut for testing the software as it is developed. The use of the Aquanaut is included in the 18-month lease portion of the contract. The Hydronaut, in contrast, is not included in the lease portion, but instead is chartered through the engineering services portion of the contract as a direct cost to the program. The Hydronaut supports the offshore operations of the Aquanaut that is required to meet the mission goals of the contract. All support costs for the Aquanaut and Hydronaut are included in the lease and charter fees charged to the customer. The “charter fees” represent the fee we charge the Large Confidential Government Contractor under the engineering portion of the contract for use of this vessel. It is considered “Other Direct Costs” to the program. The “engineering services” include labor and other costs to the program of which, the Hydronaut charter (\$6,000 per day) is an example.

Additionally, there are some other features of the lease agreement that are similar to a RaaS contract, such as all-inclusive access. However, since a lease agreement more often secures the availability of an asset and not the specific performance of a service, this contract is not “precisely” a RaaS agreement. Nauticus provides all labor and other operating costs associated with the deployment of the Hydronaut and Aquanaut, unless otherwise prescribed by the secondary contract that the lease supports.

In contrast to this arrangement, the “pure” RaaS model (a business model planned for future commercial services but not yet implemented) that is deployed in a “pure” commercial sense has all costs covered in the rate billed out for the service. One such example is the Nauticus RaaS model which will bill out at a rate of \$40,000 per day and will cover all costs associated with that operation. Additionally, the long term commercial RaaS model (a business model planned for future commercial services but not yet implemented) is envisioned to allow for shorter term ‘subscriptions’ to the Aquanaut/Hydronaut assets and not require long term master service agreement arrangements with end clients. This will permit for more opportunistic customer acquisitions and ‘call out’ workflow, which is analogous to the difference between renting a car for a work trip and leasing a car for 5 years.

After our lease expires this fiscal year with our U.S. governmental customer, a prospective customer could subscribe to the current Aquanaut through Nauticus’ RaaS arrangement, once it becomes available. Subsequently, once we complete the three (3) additional Aquanauts in Q3 of 2022, and as soon as the units are commissioned, they will be available for customer usage.

[Table of Contents](#)

Additionally, Nauticus is deeply networked into the world energy sector through its longtime partnerships with Schlumberger and Transocean. Nauticus and Schlumberger partnered together and proposed to a multi-year, potentially greater than \$10,000,000 valued, competitive opportunity from a larger oil and gas operator. The possible award notification is imminent and is expected by the end of the second quarter of 2022. Nauticus is also engaged by Super Major, which has awarded a first stage contract that will result in a pilot of the RaaS service in the Summer of 2022. Nauticus has also held numerous meetings at its office with representatives from global perspective customers seeking an improved method for performing subsea maintenance activities. As the Nauticus fleet of robotic systems are commissioned in the 4th quarter of 2022, Nauticus anticipates elevated interest from subsea energy operators as they explore methods for lowering costs associated with maintaining their subsea assets.

Nauticus' revenue forecast is based on certain contractual arrangements, letters of intent, memoranda of understanding, sales pipeline developed through its business development efforts and expectation of launching its commercial services fleet under the RaaS business model, as presented in the tables above. CLAQ's management analyzed these arrangements by volume, ability to manufacture such quantities with quality-controls in place, and timing of expected delivery, as presented in the tables above.

The forecast also assumes that Nauticus' commercial RaaS model is priced at a discount to the next best alternative given the disruptive nature of its technology, while maintaining strong margins. The cost of providing such services is expected to decline over the projection period due to the expected increasing in autonomy of the Hydronaut over the projection period.

Nauticus' forecast also assumes Aquanaut build and assembly time per unit to decrease from six months in 2022 and 2023 to three months in 2024. Nauticus also expects its engineering, research, development, general and administrative costs to increase during the projection period based on a combination of bottom-up budgeting and as a percentage of revenue. General and administrative expenses also reflect costs associated with operating as a public company and complying with legal, accounting and other regulatory requirements.

Aquanaut will be under a long term RaaS contract (a business model planned for future commercial services but not yet implemented) to perform data gathering and intervention operations for a contract through a Large Confidential Government Contractor, for a government customer. Nauticus is currently performing as a subcontractor to a Large Confidential Government Contractor to complete the program objectives. For commercial markets, Nauticus expects the RaaS model (a business model planned for future commercial services but not yet implemented) to begin with the introduction of Aquanauts to the North Sea and/or Gulf of Mexico. Our financial projections reflect a modest 10 days on hire in the 4th quarter of 2022 as this vehicle completes commissioning and begins commercial service. As the fleet grows in 2023, the projections assume a reduced number of days on hire per vehicle to account for the market acceptance. In 2024, the commercial service fleet reaches full utilization with each available vehicle conducting 50 days of work per quarter. The overall commercial fleet size is projected to reach 78 vehicles by 2026 which will constitute approximately less than 5% of the current world-wide market of subsea vehicles in this class.

Staff increases are projected for the headquarters offices in Houston (Webster, TX), remote operations centers, and service fleet crew. Three remote operations centers were modeled in the financial projections — one in the UK for the North Sea, Singapore for Asia/Pacific, and Brazil. The Houston office will support operations in the Gulf of Mexico. The remote operations centers cover the primary markets for subsea robotics. Headquarters staffing projections utilize a 'bottom up' staffing projection for 2022 based on near-term staff requirements followed by a transition to a percentage of revenue for each department, estimated to be between 2.5-5%, in 2023 and subsequent years. The set up and operating costs for the remote centers were computed based on a detailed analysis of expected costs in both up front ("CapEx") costs as well as the ongoing operational cost ("OpEx") to support the commercial fleet services. Once established, the OpEx costs were increased 5% per year to account for inflation and growth. Service fleet crew labor cost is computed as a function of days on hire so this labor category increases as the days on hire increase. The crew cost is modeled to be reduced in the outyears to account for increased automation in the Hydronauts that will result in less crew overtime and eventually perform the entire mission without crew on the vessel.

Manufacturing (labor) cost per vehicle was estimated at \$250K/vehicle by a detailed, bottom-up cost analysis. The financial projections assume a growth of 5% per year in this cost to account for labor cost. The component, or Bill of Materials, costs per vehicle were held constant across the multi-year projection with the assumption that reductions due to the economies of scale are offset by increases in component cost. The manufacturing schedule contained in the financial model is driven by the commercial service fleet size and the unit sales pipeline for Aquanaut and Argonaut vehicles. The manufacturing rate begins with a one vehicle produced in six months in an assembly bay and moves to one

vehicle in three 3 months in the outyears to account for production efficiency gains. Outyear production costs increase to account for expected increases in production of vehicles for the commercial fleet, unit vehicle sales, and US Department of Defense.

Maintenance costs for fleet vehicles were derived from internal industry knowledge and reflected in the day rate costs. These costs for vehicle repair and maintenance are reflected in the day rate cost and increase at a rate of about 10% per year.

The revenue projections in the financial analysis are based on the established sales pipeline in the near term and market demand and expectations in the outyears. The associated cost estimates are based on historical business performance and bottom-up budget analyses for each business segment.

The CLAQ Board compared Nauticus' forecasts to the market capitalization, enterprise value and implied valuation multiples of its selected publicly traded company peer set.

The key selection criteria used to determine the comparable companies included, among others, the following factors: (i) the products or services offered, (ii) business model similarity in revenue recurrence, (iii) revenue growth profile, and (iv) gross margin. Companies were selected because they demonstrate (a) similar product or service offerings as Nauticus', and (b) leading technology applied in their respective product or service offerings. The comparable companies were broken down into two distinct sets of public companies, which can be summarized as follows:

- (A) Primary Comparable Companies (Two Pure-Play RaaS companies — Sarcos Technology and Robotics Corporation, Berkshire Grey, Inc.): These selected companies operate in the Robotics sector and engage in a business model that aims to provide recurring revenue under a Robotics-as-a-Service business model. These companies are generally expected to have revenue growth and gross margin profile comparable to Nauticus. As of November 15, 2021, the "Pure-Play RaaS" peer group's enterprise value/2024 estimated revenue median multiple was 5.0x, and enterprise value/2024 estimated EBITDA median multiple was 33.0x.
- (B) Secondary Comparable Companies:
 - a. 10 Robotics & Automation companies (Keyence Corporation, Intuitive Surgical, Inc., ABB Ltd, Fanuc Corporation, Hexagon AB, Rockwell Automation, Inc., AMETEK, Inc., Cognex Corporation, Teledyne Technologies Incorporated and Siasun Robot&Automation Co.,Ltd.): These selected companies operate in the broader Robotics and Automation industry but are larger and have a more mature growth profile than Nauticus. As of November 15, 2021, the "Robotics & Automation" peer group's enterprise value/2024 estimated revenue median multiple was 5.8x, and enterprise value/2024 estimated EBITDA median multiple was 18.4x.
 - b. Seven Disruptive Category Creator companies (Tesla, Inc., Uber Technologies, Inc., Autodesk, Inc., Palantir Technologies Inc., Sunrun Inc., C3.ai, Inc., Proto Labs, Inc.): These selected companies have brought technological disruption to their respective industries, thereby gaining a first-mover advantage over their competition. As of November 15, 2021, the "Disruptive Category Creator" peer group's enterprise value/2024 estimated revenue median multiple was 8.2x, and enterprise value/2024 estimated EBITDA median multiple was 29.9x.
 - c. Nine All-Electric Autonomous Platform companies (Faraday Future Intelligent Electric Inc., Canoo Inc., Velodyne Lidar, Inc., Ouster, Inc., Innoviz Technologies Ltd., Arrival, Lillium N.V., Luminar Technologies, Inc., Proterra Inc.): These selected companies operate in the expanding mobility industry driven by adoption of new technology, and are generally expected to exhibit revenue growth comparable to Nauticus. As of November 15, 2021, the "All-Electric Autonomous Platform" peer group's enterprise value/2024 estimated revenue median multiple was 2.5x, and enterprise value/2024 estimated EBITDA median multiple was 28.5x.
 - d. Four Energy Transition & Clean-Tech companies (EVgo, Inc., ESS Tech, Inc., ChargePoint Holdings, Inc., QuantumScape Corporation): These selected companies operate in the expanding Energy Transition & Clean-Tech industry driven by adoption of new technology, and are generally

expected to exhibit revenue growth comparable to Nauticus. As of November 15, 2021, the “Energy Transition & Clean-Tech” peer group’s enterprise value/2024 estimated revenue median multiple was 9.9x, and enterprise value/2024 estimated EBITDA median multiple was 35.0x.

Although none of the above selected publicly traded companies are directly comparable to Nauticus, CLAQ reviewed these companies and considered them Nauticus’ peer set because, among other things, these companies have one or more similar operating and financial characteristics as Nauticus. In determining its valuation range based on the peer set, CLAQ relied primarily on Pure-Play RaaS companies, Sarcos Technology and Robotics Corporation and Berkshire Grey, Inc and secondarily on the remaining companies in the peer set.

CLAQ management found that Nauticus’ equity value of approximately \$300 million implied a pro forma enterprise value of 1.9x estimated 2024 revenue and 3.4x estimated 2024 EBITDA, an attractive valuation relative to the peer set especially in light of Nauticus’ strong growth and projected margin profile. Using a range of enterprise value/revenue and enterprise value/EBITDA multiples of Nauticus’s primary and secondary public company peer sets, CLAQ management calculated the implied enterprise value of Nauticus to be in the range of \$0.9 billion and \$3.1 billion, a significant upside to the \$377 million of pro forma enterprise value called for in the transaction with Nauticus.

Interests of Certain Persons in the Business Combination

When you consider the recommendation of the Board in favor of adoption of the Business Combination Proposal and other Proposals, you should keep in mind that CLAQ’s directors and officers and their affiliates have interests in the Business Combination that are different from, or in addition to, your interests as a shareholder, including:

- CLAQ’s Co-sponsors have a fiduciary obligation to each of their respective members and Eli Spiro, (CLAQ’s Chief Executive Officer and Director) and Jonas Grossman (a CLAQ Director) are the controlling members of our Co-sponsors. Because each of Mr. Spiro and Mr. Grossman have a fiduciary obligation to both CLAQ and the Co-sponsors, they had a conflict of interest when voting on the Business Combination.
- If an initial business combination, such as the Business Combination, is not completed, CLAQ will be required to dissolve and liquidate. In such event, the 4,312,500 founder shares currently held by the Initial Stockholders, which were acquired prior to the IPO will be worthless because such holders have agreed to waive their rights to any liquidation distributions. The founder shares were purchased for an aggregate purchase price of \$25,000, and had an aggregate market value of approximately \$43.3 million based on the closing price of \$10.03 per share of CLAQ common stock on the Nasdaq Stock Market as of May 20, 2022.
- If an initial business combination, such as the Business Combination, is not completed, an aggregate of 7,175,000 Private Warrants purchased by CLAQ’s Co-sponsors for a total purchase price of \$7,175,000, will be worthless. The Private Warrants had an aggregate market value of approximately \$3.0 million based on the closing price of \$0.42 per Public Warrant on the Nasdaq Stock Market as of May 20, 2022.
- Because of these interests, CLAQ’s Initial Stockholders could benefit from the completion of a business combination that is not favorable to its public shareholders and may be incentivized to complete an acquisition of a less favorable target company or on terms less favorable to public shareholders rather than liquidate. For example, if the share price of the CLAQ common stock declined to \$5.00 per share after the close of the business combination, CLAQ’s public shareholder that purchased shares in the initial public offering, would have a loss of \$5.00 per share, while CLAQ’s Sponsor would have a gain of \$4.99 per share because it acquired the founder shares for a nominal amount. In other words, CLAQ’s Initial Stockholders can earn a positive rate of return on their investment even if public shareholders experience a negative rate of return in the post-combination company.
- One of CLAQ’s Co-sponsors is CleanTech Sponsor, and the managing member of CleanTech Sponsor is Eli Spiro, CLAQ’s Chief Executive Officer and Director. If an initial business combination, such as the Business Combination, is not completed, CleanTech Sponsor will lose an aggregate of approximately \$28.3 million, comprised of the following:
 - approximately \$26.0 million (based on the closing price of \$10.03 per share of CLAQ common stock on the Nasdaq Stock Market as of May 20, 2022) of the 2,595,000 founder shares CleanTech Sponsor holds;

Table of Contents

- approximately \$2.0 million (based on the closing price of \$0.42 per Public Warrant on the Nasdaq Stock Market as of May 20, 2022) of the 4,783,333 Private Warrants CleanTech Sponsor holds; and
- repayment of an interest-free loan of \$267,000 by CleanTech Sponsor since the loan will become payable only after Closing of the Business Combination, or the date on which CLAQ determines that it is unable to effect a business combination.
- CLAQ's other Co-sponsor, CleanTech Investments, is an affiliate of Chardan, and CLAQ's director, Mr. Jonas Grossman, is the Managing Partner and President of Chardan. If an initial business combination, such as the Business Combination, is not completed, Chardan will lose an aggregate of approximately \$23.8 million, comprised of the following:
 - approximately \$14.4 million (based on the closing price of \$10.03 per share of CLAQ common stock on the Nasdaq Stock Market as of May 20, 2022) of the 1,437,500 founder shares CleanTech Investment holds;
 - approximately \$1.0 million (based on the closing price of \$0.42 per Public Warrant on the Nasdaq Stock Market as of May 20, 2022) of the 2,391,667 Private Warrants CleanTech Investment holds;
 - a marketing fee of \$6,037,500 for certain services pursuant to a Business Combination Marketing Agreement;
 - a placement fee of \$2,118,000 (i.e., 6.0% of the PIPE Investment that is not sold to an affiliate of Chardan) for certain services pursuant to the Financial Advisory Agreement (pursuant to the Financial Advisory Agreement, Chardan also has a right of first refusal to act as a book-running manager with minimum economics of 15% for the first two public or private equity offerings by CLAQ or any successor or subsidiary of CLAQ);
 - repayment of an interest-free loan of \$133,000 by CleanTech Investments since the loan will become payable only after Closing of the Business Combination, or the date on which CLAQ determines that it is unable to effect a business combination; and
 - the \$10,000 monthly administrative fee under the Administrative Support Agreement pursuant to which CLAQ may delay payment of the same until the consummation of a business combination. As of March 2022, there is an accrued and unpaid balance of \$83,333 owed to Chardan under the Administrative Support Agreement.
- If an initial business combination, such as the Business Combination, is not completed, the Initial Stockholders will lose a combined aggregate amount of approximately \$46.7 million (including the Co-sponsors' loans and securities held based on the closing price of \$10.03 per share of CLAQ common stock and \$0.42 per Public Warrant on May 20, 2022), and the Initial Stockholders together with their affiliates (including Chardan) will lose a combined aggregate amount of approximately \$54.9 million (including Chardan's fees contingent upon the Closing of the Business Combination.)
- If the proposed Business Combination is not completed, CLAQ's Initial Stockholders will not have the potential ownership interest of approximately 6.8% (assuming no redemption) or 8.6% (assuming maximum redemption) in the combined company, assuming exercise and conversion of all securities.
- As of the date of this proxy statement/prospectus, ATW is the only purchaser for the Debentures and associated Warrants in the Debt Financing. ATW is managed by ATW Partners Opportunities Management, LLC, which is an affiliate of Chardan, and our director, Mr. Jonas Grossman, is the Managing Partner and President of Chardan.
- The exercise of CLAQ's directors' and officers' discretion in agreeing to changes or waivers in the terms of the transaction may result in a conflict of interest when determining whether such changes or waivers are appropriate and in our stockholders' best interest.
- If the Business Combination is completed, Nauticus will designate all members of the Combined Company's Board of Directors, except for the Transocean Designee).

Anticipated Accounting Treatment

The Business Combination is accounted for as a reverse recapitalization, with no goodwill or other intangible assets recorded, in accordance with GAAP. Under this method of accounting, CLAQ is treated as the “acquired” company for financial reporting purposes. Nauticus has been determined to be the accounting acquirer because Nauticus, as a group, will retain a majority of the outstanding shares of the combined company as of the closing of the Business Combination, they have nominated eight of the nine members of the board of directors as of the closing of the Business Combination, Nauticus’ management will continue to manage the combined company and Nauticus’ business will comprise the ongoing operations of the Combined Company.

Sources and Uses for the Business Combination

The following tables summarize the sources and uses for funding the Business Combination (i) assuming that none of CLAQ’s outstanding shares of Common Stock are redeemed in connection with the Business Combination and (ii) assuming that a portion of CLAQ’s outstanding shares of Common Stock are redeemed in connection with the Business Combination. For an illustration of the number of shares and percentage interests outstanding under each scenario see the section entitled “Unaudited Pro Forma Condensed Combined and Consolidated Financial Information.”

No Redemption

Sources of Funds (in millions)		Uses (in millions)	
Cash held in Trust Account ⁽¹⁾	\$ 174.2	Common stock of combined company issued to Nauticus stockholders ⁽²⁾	\$ 300.3
PIPE Investment	72.5	Transaction and other costs ⁽³⁾	21.9
Common stock of combined company issued to Nauticus stockholders ⁽²⁾	300.3	Cash to combined company Balance Sheet	224.8
Total Sources	\$ 547.0	Total Uses	\$ 547.0

- (1) As of March 31, 2022.
 (2) Shares issued to Nauticus stockholders are at a deemed value of \$10.00 per share. Assumes 30,031,279 shares of Common Stock issued. See the section entitled “Unaudited Pro Forma Condensed Combined and Consolidated Financial Information” for more details.
 (3) Represents an estimated amount, inclusive of fees related to the Business Combination, related transactions and CLAQ promissory note repayment.

Maximum Redemption

Sources of Funds (in millions)		Uses (in millions)	
Cash held in Trust Account ⁽¹⁾	\$ —	Common stock of combined company issued to Nauticus stockholders ⁽²⁾	\$ 300.3
PIPE Investment	72.5	Transaction and other costs ⁽³⁾	21.9
Common stock of combined company issued to Nauticus stockholders ⁽²⁾	300.3	Cash to combined company Balance Sheet	50.6
Total Sources	\$ 372.8	Total Uses	\$ 372.8

- (1) As of March 31, 2022 assumes that 17,250,000 Public Common Stock subject to redemption are redeemed for an aggregate payment of approximately \$174.2 million (based on an estimated per share redemption price of approximately \$10.10 that was calculated using the \$174.2 of cash in the Trust Account divided by 17,250,000 Public Common Stock subject to redemption assuming the pro forma maximum redemption scenario pursuant to the Merger Agreement). Under the terms of the Merger Agreement, the aggregate cash proceeds received from the Trust Account, together with the proceeds from the PIPE Investment and after the payment of transaction expenses, must equal no less than \$50.0 million.
 (2) Shares issued to Nauticus stockholders are at a deemed value of \$10.00 per share. Assumes 30,031,279 shares of Common Stock issued. See the section entitled “Unaudited Pro Forma Condensed Combined and Consolidated Financial Information” for more details.
 (3) Represents an estimated amount, inclusive of fees related to the Business Combination, related transactions and CLAQ promissory note repayment.

Appraisal Rights

There are no appraisal rights available to our stockholders in connection with the Business Combination.

Total Shares of Common Stock Outstanding Upon Consummation of the Business Combination

Ownership of the Post-Business Combination Company After the Closing

It is anticipated that upon completion of the Business Combination and assuming no redemptions by CLAQ public stockholders, CLAQ's public stockholders (other than the Equity Financing investors) will retain an ownership interest of approximately 28.5% in the Combined Company the Equity Financing investors will own approximately 5.6% of the Combined Company, the Co-Sponsors, officers, directors and other holders of founder shares will retain an ownership interest of approximately 6.8% of the Combined Company, and the Nauticus stockholders will own approximately 59.1% (including the 7,500,000 Earnout Shares) of the Combined Company.

The following tables illustrate estimated ownership levels in the Company, immediately following the consummation of the Business Combination, based on the varying levels of redemptions by CLAQ public stockholders and the following additional assumption:

	No Redemptions ⁽¹⁾		10% Redemption ⁽²⁾		50% Redemption ⁽³⁾		75% Redemption ⁽⁴⁾		Maximum Redemption ⁽⁵⁾	
		%		%		%		%		%
Nauticus										
stockholders ⁽⁶⁾	37,531,279	59.1%	37,531,279	60.8%	37,531,279	68.4%	37,531,279	74.3%	37,531,279	81.2%
CLAQ public										
stockholders ⁽⁷⁾	18,112,500	28.5%	16,387,500	26.5%	9,487,500	17.3%	5,175,000	10.2%	862,500	1.9%
Initial										
Stockholders ⁽⁸⁾⁽⁹⁾	4,312,500	6.8%	4,312,500	7.0%	4,312,500	7.9%	4,312,500	8.5%	4,312,500	9.3%
PIPE Investment										
investors ⁽¹⁰⁾	3,530,000	5.6%	3,530,000	5.7%	3,530,000	6.4%	3,530,000	7.0%	3,530,000	7.6%
Pro forma common stock at March 31, 2022										
	63,486,279	100.0%	61,761,279	100.0%	54,861,279	100.0%	50,548,779	100.0%	46,236,279	100.0%
<i>Potential sources of dilution:</i>										
Public Warrants	8,625,000	13.6%	8,625,000	14.0%	8,625,000	15.7%	8,625,000	17.1%	8,625,000	18.7%
Private Warrants	7,175,000	11.3%	7,175,000	11.6%	7,175,000	13.1%	7,175,000	14.2%	7,175,000	15.5%
Nauticus Options	3,977,368	6.3%	3,977,368	6.4%	3,977,368	7.2%	3,977,368	7.9%	3,977,368	8.6%
Debentures	3,036,735	4.8%	3,036,735	4.9%	3,036,735	5.5%	3,036,735	6.0%	3,036,735	6.6%
Warrants	3,036,735	4.8%	3,036,735	4.9%	3,036,735	5.5%	3,036,735	6.0%	3,036,735	6.6%

- (1) Assumes that no CLAQ public stockholders are redeemed and excludes potential dilution from sources of dilution.
- (2) Assumes that 1,725,000 Public Common Stock is redeemed for aggregate redemption payments of approximately \$17,424,797, assuming a \$10.10 per share redemption price and based on funds in the Trust Account as of March 31, 2022. The Merger Agreement includes a condition to the closing that at the closing having an amount of available cash from the Trust Account and the PIPE Investment (after giving effect to the redemption of any Public Common Stock in connection with the IPO and the payment of the transaction expenses), of no less than \$50,000,000.
- (3) Assumes that 8,625,000 Public Common Stock is redeemed for aggregate redemption payments of approximately \$87,123,987, assuming a \$10.10 per share redemption price and based on funds in the Trust Account as of March 31, 2022. The Merger Agreement includes a condition to the closing that at the closing having an amount of available cash from the Trust Account and the Equity Financing (as defined in the Merger Agreement) (after giving effect to the redemption of any Public Common Stock in connection with the IPO and the payment of the transaction expenses), of no less than \$50,000,000.
- (4) Assumes that 12,937,500 Public Common Stock is redeemed for aggregate redemption payments of approximately \$130,685,980, assuming a \$10.10 per share redemption price and based on funds in the Trust Account as of March 31, 2022. The Merger Agreement includes a condition to the closing that at the closing having an amount of available cash from the Trust Account and the Equity Financing (as defined in the Merger Agreement) (after giving effect to the redemption of any Public Common Stock in connection with the IPO and the payment of the transaction expenses), of no less than \$50,000,000.
- (5) Assumes that 17,250,000 Public Common Stock is redeemed for aggregate redemption payments of approximately \$174,247,973, assuming a \$10.10 per share redemption price and based on funds in the Trust Account as of March 31, 2022. The Merger Agreement includes a condition to the closing that at the closing having an amount of available cash from the Trust Account and the PIPE Investment (after giving effect to the redemption of any Public Common Stock in connection with the IPO and the payment of the transaction expenses), of no less than \$50,000,000.
- (6) Includes 7,500,000 Earnout Shares subject to the Triggering Events. Such shares will be deposited into escrow in accordance with the terms of the Merger Agreement and will be subject to reduction or forfeiture in accordance with the terms of the Merger Agreement. However, registered holders will maintain voting rights related to such shares unless forfeited.
- (7) Excludes 8,625,000 Public Warrants and includes the issuance of 862,500 shares of Common Stock pursuant to the Rights. If all potential sources of dilution were exercised and converted into Common Stock the CLAQ public stockholders would hold approximately 20.3%, 18.7%, 11.8%, 6.8% and 1.2% under the No Redemptions, 10% Redemption, 50% Redemption, 75% Redemption, and Maximum Redemption scenarios, respectively. See "Risk Factors — Risks Related to CLAQ's Business

Table of Contents

- and the Business Combination — The CLAQ Public Stockholders will experience dilution as a consequence of, among other transactions, the issuance of Common Stock as consideration in the Business Combination and the PIPE Investment” for additional information related to the risk of dilution to our public stockholders.
- (8) Excludes 7,175,000 Private Warrants. If all potential sources of dilution were exercised and converted into Common Stock the Initial Stockholders would hold approximately 4.8%, 4.9%, 5.3%, 5.6% and 6.0% under the No Redemptions, 10% Redemption, 50% Redemption, 75% Redemption, and Maximum Redemption scenarios, respectively. See “Risk Factors — Risks Related to CLAQ’s Business and the Business Combination — The CLAQ Public Stockholders will experience dilution as a consequence of, among other transactions, the issuance of Common Stock as consideration in the Business Combination and the PIPE Investment” for additional information related to the risk of dilution to our public stockholders.
- (9) Total of 4,312,500 outstanding founder shares includes 1,437,500 founder shares held by the Sponsor, 2,595,000 founder shares held by CleanTech Investments, and 280,000 founder shares held by the officers and directors of CleanTech. Please see the section titled “Beneficial Ownership of Securities.”
- (10) Assumes the sale of an aggregate of 3,530,000 shares of CleanTech Common Stock, for a purchase price of \$10.00 per share and an aggregate purchase price of \$35,300,000. Excludes the dilution that could be caused by the conversion of the Debentures and Warrants issued pursuant to the Securities Purchase Agreement.

Redemption Rights

Pursuant to our Certificate of Incorporation, holders of Public Common Stock may elect to have their Common Stock redeemed for cash at the applicable redemption price per share equal to the quotient obtained by dividing (i) the aggregate amount on deposit in the Trust Account as of two business days prior to the consummation of the Business Combination, including interest (net of taxes payable), by (ii) the total number of then-outstanding Public Common Stock. As of _____, 2022, this would have amounted to approximately \$ _____ per share.

You will be entitled to receive cash for any Public Common Stock to be redeemed only if you:

- (i) (a) hold Public Common Stock, or
- (b) hold Public Common Stock through public Units and you elect to separate your public Units into the underlying Public Common Stock prior to exercising your redemption rights with respect to the Public Common Stock; and
- (ii) prior to _____ a.m./p.m., Eastern Time, on _____, 2022, (a) submit a written request to Continental that CLAQ redeem your Public Common Stock for cash and (b) deliver your Public Common Stock to Continental, physically or electronically through DTC.

Holders of outstanding Units must separate the underlying Common Stock prior to exercising redemption rights with respect to the Public Common Stock. If the Units are registered in a holder’s own name, the holder must deliver the certificate for its Units to Continental, with written instructions to separate the Units into their individual component parts. This must be completed far enough in advance to permit the mailing of the certificates back to the holder so that the holder may then exercise his, her or its redemption rights upon the separation of the Public Common Stock from the Units.

If a holder exercises its redemption rights, then such holder will be exchanging its Public Common Stock for cash and will no longer own securities of the Combined Company. Such a holder will be entitled to receive cash for its Public Common Stock only if it properly demands redemption and delivers its Common Stock (either physically or electronically) to Continental in accordance with the procedures described herein. Please see the section titled “The Meeting — Redemption Rights” for the procedures to be followed if you wish to redeem your Public Common Stock for cash.

Vote Required for Approval

Along with the approval of the Charter Approval Proposal, the Bylaws Proposal, the Directors Proposal, the Stock Plan Proposal, the Nasdaq Merger Proposal and the Nasdaq PIPE Proposal, approval of this Business Combination Proposal is a condition to the consummation of the Business Combination. If this Business Combination Proposal is not approved, the Business Combination will not take place. Approval of this Business Combination Proposal is also a condition to Proposal 2, Proposal 3, Proposals 4A-4E, Proposal 5, Proposal 6, Proposal 7, and Proposal 8. If the Charter Approval Proposal, the Bylaws Proposal, the Directors Proposal, the Stock Plan Proposal, the Nasdaq Merger Proposal and the Nasdaq PIPE Proposal are not approved, unless the condition is waived, this Business Combination Proposal will have no effect (even if approved by the requisite vote of our stockholders at the Meeting of any adjournment or postponement thereof) and the Business Combination will not occur.

[Table of Contents](#)

This Business Combination Proposal (and consequently, the Merger Agreement and the transactions contemplated thereby, including the Business Combination) will be approved and adopted only if holders of at least a majority of the issued and outstanding shares of common stock present in person by virtual attendance or represented by proxy and entitled to vote at the Meeting vote “FOR” the Business Combination Proposal.

Pursuant to the Letter Agreement, the Initial Stockholders holding an aggregate of 4,312,500 shares (or 20.0% of the outstanding shares) of common stock have agreed to vote their respective shares of common stock in favor of the Combination Proposal. Pursuant to the Sponsor Support Agreement, the Co-Sponsors holding an aggregate of 4,032,500 shares of common stock or approximately 18.7% of the outstanding shares of common stock have agreed to vote their respective shares in favor of the Combination Proposal. As a result, only 1,0781,126 shares of common stock held by the public stockholders will need to be present in person by virtual attendance or by proxy to satisfy the quorum requirement for the meeting. In addition, as the vote to approve the Business Combination Proposal is a majority of the votes cast at a meeting at which a quorum is present, assuming only the minimum number of shares of common stock to constitute a quorum is present, only 539,063 shares of common stock, or approximately 3.1% of the outstanding shares of the common stock held by the public stockholders must vote in favor of the Business Combination Proposal for it to be approved.

Board Recommendation

OUR BOARD RECOMMENDS THAT OUR STOCKHOLDERS VOTE “FOR” THE BUSINESS COMBINATION PROPOSAL 1.

PROPOSAL 2 — THE CHARTER APPROVAL PROPOSAL

Overview

Our stockholders are being asked to adopt the Amended Charter in the form attached to this proxy statement/prospectus as *Annex B*, which, in the judgment of the CLAQ Board, is necessary to adequately address the needs of Combined Company.

The following is a summary of the key amendments effected by the Amended Charter, but this summary is qualified in its entirety by reference to the full text of the Amended Charter, a copy of which is attached to this proxy statement/prospectus as *Annex B*:

- **Changes to Authorized Capital Stock**— the Current Charter authorized the issuance of 31,000,000 total shares, consisting of (a) 30,000,000 shares of common stock and (b) 1,000,000 shares of preferred stock. The Amended Charter authorizes the issuance of _____ total shares, consisting of (a) _____ shares of common stock, and (b) _____ shares of preferred stock;
- **Required Vote to Amend the Charter** — require an affirmative vote of holders of at least two-thirds (66 and 2/3%) of the voting power of all the then outstanding shares of voting stock of the Combined Company entitled to vote generally in an election of directors to amend, alter, repeal or rescind, in whole or in part, certain provisions of the Amended Charter;
- **Required Vote to Amend the Bylaws** — require an affirmative vote of holders of at least two-thirds (66 and 2/3%) of the voting power of all the then outstanding shares of voting stock of the Combined Company entitled to vote generally in an election of directors to adopt, amend, alter, repeal or rescind the Combined Company's bylaws;
- **Classified Board** — divide the Combined Company's board of directors into three classes, designated as Class I, Class II, and Class III, with only one class of directors being elected each year and each class (except for those directors appointed prior to the first annual meeting of shareholders) serving a three-year term.
- **Director Removal** — provide for the removal of directors with cause only by stockholders voting at least two-thirds (66 and 2/3%) of the voting power of all of the then outstanding shares of voting stock of the Combined Company entitled to vote at an election of directors; and
- **Removal of Blank Check Company Provisions** — eliminate various provisions applicable only to blank check companies, including business combination requirements.

Reasons for the Amendments

Each of these amendments was negotiated as part of the Business Combination. The CLAQ Board's reasons for proposing each of these amendments to the Current Charter is set forth below.

Changes to Authorized Capital Stock

Our Current Charter authorizes 31,000,000 shares, consisting of (a) 30,000,000 shares of common stock, including and (b) 1,000,000 shares of preferred stock. The Amended Charter provides that CLAQ will be authorized to issue _____ shares, consisting of _____ shares of common stock and _____ shares of preferred stock.

This amendment also increases the authorized number of shares because our board of directors believes that it is important for us to have available for issuance a number of authorized shares of common stock and preferred stock sufficient to support our growth and to provide flexibility for future corporate needs (including, if needed, as part of financing for future growth acquisitions). The shares would be issuable as consideration for the merger and the other transactions contemplated by in this proxy statement/prospectus, and for any proper corporate purpose, including future acquisitions, capital raising transactions consisting of equity or convertible debt, stock dividends or issuances under current and any future stock incentive plans.

The CLAQ board of directors believes that these additional shares will provide us with needed flexibility to issue shares in the future in a timely manner and under circumstances we consider favorable without incurring the risk, delay, and potential expense incident to obtaining stockholder approval for a particular issuance.

Required Vote to Amend the Charter

At present, our Current Charter may only be amended with the approval of a majority of the CLAQ Board and the holders of a majority of our outstanding shares. This amendment requires an affirmative vote of holders of at least two-thirds (66 and 2/3%) of the voting power of all the then-outstanding shares of voting stock of the Combined Company entitled to vote generally in an election of directors to amend, alter, repeal or rescind certain provisions of the Amended Charter. We believe that supermajority voting requirements are appropriate at this time to protect all stockholders against the potential self-interested actions by one or a few large stockholders. In reaching this conclusion, the CLAQ Board was cognizant of the potential for certain stockholders to hold a substantial beneficial ownership of our common stock following the Business Combination. We further believe that going forward, a supermajority voting requirement encourages the person seeking control of the Combined Company to negotiate with the board of directors to reach terms that are appropriate for all stockholders.

Required Vote to Amend the Bylaws

At present, our Current Charter provides that our bylaws may be amended by the affirmative vote of the holders of a majority of the voting power of all then outstanding shares of capital stock entitled to vote generally in the election of directors, voting together as a single class. This amendment requires an affirmative vote of holders of at least two-thirds (66 and 2/3%) of the voting power of all the then outstanding shares of voting stock of the Combined Company entitled to vote generally in an election of directors to adopt, amend, alter, repeal or rescind the Combined Company's bylaws. The ability of the majority of the Board to amend the bylaws remains unchanged. We believe that supermajority voting requirements are appropriate at this time to protect all stockholders against the potential self-interested actions by one or a few large stockholders. In reaching this conclusion, the CLAQ Board was cognizant of the potential for certain stockholders to hold a substantial beneficial ownership of our common stock following the Business Combination. We further believe that going forward, a supermajority voting requirement encourages the person seeking control of the Combined Company to negotiate with the board of directors to reach terms that are appropriate for all stockholders.

Classified Board

At present, our Current Charter provides that all directors are elected annually. This amendment will provide that the Combined Company's board be divided into three classes with only one class of directors being elected each year and each class (except for those directors appointed prior to the first annual meeting of stockholders) serving a three-year term.

Director Removal

At present, our Current Charter provides that, directors may be removed from office at any time, but only for cause and only by the affirmative vote of holders of a majority of the voting power of all then outstanding shares of capital stock entitled to vote generally in the election of directors, voting together as a single class. This amendment provides for the removal of directors with cause only by stockholders voting at least two-thirds (66 and 2/3%) of the voting power of all of the then outstanding shares of voting stock of CLAQ entitled to vote at an election of directors. We believe that supermajority voting requirements are appropriate at this time to protect all stockholders against the potential self-interested actions by one or a few large stockholders. In reaching this conclusion, the CLAQ Board was cognizant of the potential for certain stockholders to hold a substantial beneficial ownership of our common stock following the Business Combination. We further believe that going forward, a supermajority voting requirement encourages the person seeking control of the Combined Company to negotiate with the board of directors to reach terms that are appropriate for all stockholders.

Removal of Blank Check Company Provisions

Our Current Charter contains various provisions applicable only to blank check companies. This amendment eliminates certain provisions related to our status as a blank check company, which is desirable because these provisions will serve no purpose following the Business Combination. For example, these proposed amendments remove the requirement to dissolve the Combined Company and allow it to continue as a corporate entity with perpetual existence following consummation of the Business Combination. Perpetual existence is the usual period of existence for corporations and we believe it is the most appropriate period for the Combined Company following the Business Combination. In addition, certain other provisions in our Current Charter require that proceeds from the CLAQ IPO be held in the Trust Account until a business combination or liquidation of merger has occurred. These provisions cease to apply once the Business Combination is consummated.

Vote Required for Approval

Assuming that a quorum is present at the Meeting, the affirmative vote of holders of a majority of the issued and outstanding shares of common stock on this Proposal 2 is required to approve the Charter Approval Proposal. Accordingly, a stockholder's failure to vote online during the Meeting or by proxy, a broker non-vote or an abstention will be considered a vote "AGAINST" Proposal 2.

This proposal is conditioned on the approval of the Business Combination Proposal and the Nasdaq Proposal. If either of the Business Combination Proposal or the Nasdaq Proposal is not approved, Proposal 2 will have no effect even if approved by our stockholders. **Because stockholder approval of this Proposal 2 is a condition to completion of the Merger under the Merger Agreement, if this Proposal 2 is not approved by our stockholders, the Merger will not occur unless we and Nauticus waive the applicable closing conditions.**

Board Recommendation

THE BOARD RECOMMENDS A VOTE "FOR" ADOPTION OF THE CHARTER APPROVAL PROPOSAL UNDER PROPOSAL 2.

PROPOSAL 3 — THE BYLAWS PROPOSAL

Overview

Our stockholders are being asked to adopt the Proposed Bylaws in the form attached to this proxy statement/prospectus as *Annex C*, which, in the judgment of the CLAQ Board, is necessary to adequately address the needs of Combined Company.

The following is a summary of the key amendments effected by the Proposed Bylaws, but this summary is qualified in its entirety by reference to the full text of the Proposed Bylaws, a copy of which is attached to this proxy statement/prospectus as *Annex C*:

- **Required Vote to Amend the Bylaws** — require an affirmative vote of holders of at least at least two thirds (66 and 2/3%) of the voting power of all the then outstanding shares of voting stock of the Combined Company entitled to vote generally in an election of directors to adopt, amend, alter, repeal or rescind the Combined Company's bylaws;

Reasons for the Amendments

Each of these amendments was negotiated as part of the Business Combination. The CLAQ Board's reasons for proposing each of these amendments to the current Bylaws is set forth below.

Required Vote to Amend the Bylaws

At present, our current Bylaws provides that our Bylaws may be amended (a) at any regular or special meeting of stockholders at which a quorum is present or represented, by the affirmative vote of the holders of a majority of the shares of capital stock entitled to vote, provided that notice of the proposed alteration, amendment, or repeal be contained in the notice of such meeting, or (b) by a resolution adopted by a majority of the board of directors at any regular or special meetings of the Board.

This amendment requires an affirmative vote of holders of at least two-thirds (66 and 2/3%) of the voting power of all the then outstanding shares of voting stock of the Combined Company entitled to vote generally in an election of directors to adopt, amend, alter, repeal or rescind the Combined Company's bylaws. The ability of the majority of the Board to amend the bylaws remains unchanged. We believe that supermajority voting requirements are appropriate at this time to protect all stockholders against the potential self-interested actions by one or a few large stockholders. In reaching this conclusion, the CLAQ Board was cognizant of the potential for certain stockholders to hold a substantial beneficial ownership of our common stock following the Business Combination. We further believe that going forward, a supermajority voting requirement encourages the person seeking control of the Combined Company to negotiate with the board of directors to reach terms that are appropriate for all stockholders.

Vote Required for Approval

This Proposed Bylaws will be approved and adopted only if holders of at least a majority of the issued and outstanding shares of common stock present in person by virtual attendance or represented by proxy and entitled to vote at the Meeting vote "FOR" the Proposed Bylaws. **This Bylaws Proposal is conditioned upon the approval and completion of the Business Combination Proposal, the Charter Approval Proposal, the Stock Plan Proposal, and the Nasdaq Proposal. If any of the Business Combination Proposal, the Charter Approval Proposal, the Stock Plan Proposal, or the Nasdaq Proposal are not approved, this Proposal will have no effect even if approved by our stockholders.**

Board Recommendation

THE BOARD RECOMMENDS A VOTE "FOR" ADOPTION OF THE CHARTER APPROVAL PROPOSAL UNDER PROPOSAL 3.

PROPOSALS 4A-4E — THE GOVERNANCE PROPOSALS

Overview

Our stockholders are also being asked to vote on five separate Proposals with respect to certain governance provisions in the Amended Charter, which are separately being presented in order to give CLAQ stockholders the opportunity to present their separate views on important corporate governance procedures and which will be voted upon on a non-binding advisory basis. Accordingly, regardless of the outcome of the non-binding advisory vote on these Proposals, CLAQ and Nauticus intend that the Amended Charter in the form attached to this proxy statement/prospectus as *Annex B* will take effect at the Closing of the Business Combination, assuming approval of the Charter Approval Proposal (Proposal 2). In the judgment of the Board, these provisions are necessary to adequately address the needs of the Combined Company.

Proposal 4A: Change in Authorized Shares

Description of Amendment

The amendment would provide that CLAQ will be authorized to issue shares, consisting of shares of common stock and shares of preferred stock.

Reasons for the Amendment

The amendment increases the authorized number of shares because our board of directors believes that it is important for us to have available for issuance a number of authorized shares of common stock and preferred stock sufficient to support our growth and to provide flexibility for future corporate needs (including, if needed, as part of financing for future growth acquisitions). The shares would be issuable as consideration for the merger and the other transactions contemplated by in this proxy statement/prospectus, and for any proper corporate purpose, including future acquisitions, capital raising transactions consisting of equity or convertible debt, stock dividends or issuances under current and any future stock incentive plans.

The CLAQ board of directors believes that these additional shares will provide us with needed flexibility to issue shares in the future in a timely manner and under circumstances we consider favorable without incurring the risk, delay and potential expense incident to obtaining stockholder approval for a particular issuance.

Proposal 4B: Classified Board

Description of Amendment

This amendment will provide that the Combined Company's board be divided into three classes with only one class of directors being elected each year and each class (except for those directors appointed prior to the first annual meeting of stockholders) serving a three-year term.

Reasons for the Amendment

The amendment is intended to secure continuity and stability by ensuring that at any given time a majority of the directors will have prior experience with the Combined Company and, therefore, be familiar with its business and operations. The board of directors also believes that this classification will assist the Combined Company's board of directors in protecting the interests of the Combined Company's stockholders in the event of an unsolicited offer for the Combined Company by encouraging any potential acquirer to negotiate directly with the Combined Company's board of directors.

Proposal 4C: Removal of Directors

Description of Amendment

The amendment provides that the Board or any director of the Board may be removed from office at any time, but only for cause and only by the affirmative vote of the holders of at least two-thirds (66 and 2/3%) of the voting power of all of the then outstanding shares of voting stock of the Combined Company entitled to vote at an election of directors.

Reasons for the Amendment

The amendment is intended to protect all stockholders against the potential self-interested actions by one or a few large stockholders by changing the standard for removal of a director to solely for cause.

Proposal 4D: Required Stockholder Vote to Amend Certain Sections of the Amended Charter

Description of Amendment

This amendment provides that in addition to any vote required by applicable law, the approval by affirmative vote of the holders of at least two-thirds (66 and 2/3%) in voting power of the then outstanding shares of the Combined Company generally entitled to vote thereon, voting together as a single class, is required to make any amendment to Part B of Article IV, Article V, Article VI, Article VII, Article VIII, and this Article IX of the Amended Charter.

Reasons for the Amendment

The CLAQ Board believes this amendment protects key provisions of the Amended Charter from arbitrary amendment and prevents a simple majority of stockholders from taking actions that may be harmful to other stockholders or making changes to provisions that are intended to protect all stockholders.

Proposal 4E: Required Stockholder Vote to Amend the Amended and Restated Bylaws

Description of Amendment

This amendment provides that the Amended and Restated Bylaws may be amended by either (i) the directors of the Board, who are expressly authorized to adopt, amend, or repeal the Amended and Restated Bylaws, or (ii) the stockholders of the Combined Company, who may vote for the adoption, amendment or repeal of the Amended and Restated Bylaws of the Combined Company with the affirmative vote of the holders of at least two-thirds (66 and 2/3%) of the voting power of all of the then outstanding shares of voting stock of the Corporation entitled to vote generally in an election of directors.

Reasons for the Amendment

The amendment is intended to protect all stockholders against the potential self-interested actions by one or more large stockholders. In addition, the CLAQ Board believes that a supermajority voting requirement encourages any person seeking control of the Combined Company to negotiate directly with the Board to reach terms that are appropriate for all stockholders.

Vote Required for Approval

The Governance Proposals will be approved and adopted only if holders of at least a majority of the issued and outstanding shares of common stock present in person by teleconference or represented by proxy and entitled to vote at the Meeting vote "FOR" the Governance Proposals.

The Business Combination is not conditioned upon the approval of the Governance Proposals.

[Table of Contents](#)

As discussed above, a vote to approve each of the Governance Proposals is an advisory vote, and therefore, is not binding on CLAQ, Nauticus or their respective boards of directors. Accordingly, regardless of the outcome of the non-binding advisory vote, CLAQ and Nauticus intend that the Amended Charter, in the form attached to this proxy statement/prospectus as Annex B and containing the provisions noted above, will take effect at the Closing of the Business Combination, assuming approval of the Charter Amendment Proposal (Proposal 2).

Board Recommendation

THE BOARD RECOMMENDS A VOTE “FOR” ADOPTION OF EACH OF THE GOVERNANCE PROPOSALS.

PROPOSAL 5 — THE DIRECTORS PROPOSAL

Election of Directors

Pursuant to the Merger Agreement, CLAQ has agreed to take all necessary action, including causing the directors of CLAQ to resign, so that effective at the Closing, the entire Board will consist of eight individuals, a majority of whom will be independent directors in accordance with the requirements of Nasdaq.

At the Meeting, it is proposed that nine directors will be elected to be the directors of the Combined Company upon consummation of the Business Combination. The Combined Company's board of directors will be reclassified following the Closing. The term of office of the Class I directors will expire at the first annual meeting of stockholders following the initial reclassification of the board of directors and Class I directors will be elected for a full term of three years. At the second annual meeting of stockholders following such initial reclassification, the term of office of the Class II directors will expire and Class II directors will be elected for a full term of three years. At the third annual meeting of stockholders following such initial reclassification, the term of office of the Class III directors will expire and Class III directors will be elected for a full term of three years. At each succeeding annual meeting of stockholders, directors will be elected for a full term of three years to succeed the directors of the class whose terms expire at such annual meeting. Subject to any limitations imposed by applicable law and subject to the special rights of the holders of any series of preferred stock to elect directors, any vacancy occurring in the Combined Company for any reason, and any newly created directorship resulting from any increase in the authorized number of directors, will, unless (a) the Combined Company's board of directors determines by resolution that any such vacancies or newly created directorships will be filled by the stockholders or (b) as otherwise provided by law, be filled only by the affirmative vote of a majority of the directors then in office, even if less than a quorum, or by a sole remaining director, and not by the stockholders.

It is proposed that the Combined Company's board of directors consist of the following directors:

- Class I directors: Jim Bellingham and Adam Sharkawy;
- Class II directors: Lisa Porter, John W. Gibson, Jr., Joseph Dyer, and Eli Spiro;
- Class III directors: Nicolaus Radford and Mark Mey.

Information regarding each nominee is set forth in the section titled "*Directors and Executive Officers of the Combined Company after the Business Combination.*"

Under Delaware law and our Bylaws, the election of directors requires a plurality vote of the common stock present in person (which would include presence at a virtual meeting) or represented by proxy and entitled to vote at the Meeting. "Plurality" means that the individuals who receive the largest number of votes cast "FOR" are elected as directors. Consequently, any shares not voted "FOR" a particular nominee (whether as a result of a direction to withhold authority or a broker non-vote) will not be counted in the nominee's favor.

Unless authority is withheld or the shares are subject to a broker non-vote, the proxies solicited by the Board will be voted "FOR" the election of these nominees. In case any of the nominees becomes unavailable for election to the Board, an event that is not anticipated, the persons named as proxies, or their substitutes, will have full discretion and authority to vote or refrain from voting for any other candidate in accordance with their judgment.

If the Business Combination Proposal is not approved, the Director Election Proposal will not be presented at the meeting.

Following consummation of the Business Combination, the election of directors of the Combined Company will be governed by the Amended Charter and bylaws and the laws of the State of Delaware.

Required Vote With Respect to the Directors Proposal

Election of each director will require the affirmative vote by a plurality of the shares of the common stock present by virtual attendance or represented by proxy and entitled to vote at the Meeting.

If the Business Combination Proposal is not approved, the Directors Proposal will not be presented at the Stockholders Meeting. The Directors Proposal will only become effective if the Business Combination is completed. Election of each of the director nominees is a condition to Closing under the Merger Agreement. If each of the directors is not elected, CLAQ is not required to close the Business Combination.

Board Recommendation

THE BOARD RECOMMENDS THAT THE STOCKHOLDERS VOTE “FOR” EACH OF THE NOMINEES SET FORTH IN THE DIRECTORS PROPOSAL.

PROPOSAL 6 — THE STOCK PLAN PROPOSAL

We are asking our stockholders to approve and adopt the Nauticus Robotics, Inc. 2022 Incentive Award Plan (the “Incentive Award Plan”) and the material terms thereunder.

The Incentive Award Plan is described in more detail below. A copy of the Incentive Award Plan is included in this proxy statement/prospectus as *Annex D*.

The Incentive Award Plan

The purpose of the Incentive Award Plan is to encourage the profitability and growth of the Company through short-term and long-term incentives that are consistent with the Company’s objectives, give participants an incentive for excellence in individual performance, promote teamwork among participants, and give the Combined Company a significant advantage in attracting and retaining key employees, non-employee directors and consultants.

If approved by our stockholders, and assuming that the Business Combination Proposal is approved, the Incentive Award Plan will become effective and will be administered by our board of directors or by a committee that our board of directors designates for this purpose (referred to below as the plan administrator), which will have the authority to make awards under the Incentive Award Plan.

After careful consideration, the CLAQ Board believes that approving the Incentive Plan is in the best interests of the Combined Company. The Incentive Award Plan promotes ownership in the Combined Company by its employees, non-employee directors and consultants, and aligns incentives between these service providers and stockholders by permitting these service providers to receive compensation in the form of awards denominated in, or based on the value of, our common stock. Therefore, the CLAQ Board recommends that our stockholders approve the Incentive Award Plan.

Summary of the Incentive Award Plan

This section summarizes certain principal features of the Incentive Award Plan. The summary is qualified in its entirety by reference to the complete text of the Incentive Award Plan to be included as *Annex D* to this Proxy Statement.

Types of Awards

To accomplish its purpose, the Incentive Award Plan permits the granting of awards in the form of incentive stock options within the meaning of Section 422 of the Code, nonqualified stock options, stock appreciation rights (“SARs”), restricted stock, restricted stock units, performance-based awards (including performance shares, performance units and performance bonus awards), and other stock-based or cash-based awards (“Awards”).

Shares Subject to the Incentive Award Plan

A total of _____ shares of common stock of the Combined Company will be reserved and available for issuance under the Incentive Award Plan. The maximum number of shares that may be issued pursuant to options intended to be incentive stock options is _____ shares, and such limit will not be subject to any annual adjustment under the Incentive Award Plan (as described below). Non-employee directors may only be granted and paid up to _____ (when taken together with any fees paid to such non-employee director) in compensation per fiscal year.

The total number of shares of common stock of the Combined Company that will be reserved and that may be issued under the Incentive Award Plan will automatically increase on the first trading day of each calendar year, beginning with calendar year 2023, by a number of shares equal to three percent (3%) of the total number of shares of common stock of the Combined Company outstanding on the last day of the prior calendar year. The plan administrator may act prior to January 1 of a given year to provide that there will be no increase in the share reserve for that year, or that the increase in the share reserve will be smaller than as provided in the Incentive Award Plan.

If an award granted under the Incentive Award Plan is forfeited, canceled, settled, or otherwise terminated the shares underlying that award will again become available for issuance under the Incentive Award Plan. However, none of the following shares will be available for issuance under the Incentive Award Plan: (i) shares delivered to or

withheld to pay withholding taxes or any applicable exercise price, or (ii) shares subject to any exercised stock settled SAR or options. In addition, any shares tendered to exercise outstanding options or other awards or repurchased on the open market using exercise price proceeds will not be available for issuance under the Incentive Award Plan. Any substitute awards shall not reduce the shares authorized for grant under the Incentive Award Plan. Shares underlying awards that are subject to the achievement of performance goals will be counted against the share reserve based on the target value of the awards unless and until the awards become vested and settled in shares of common stock. In addition, awards that may be settled only in cash will not count against the share reserve.

Administration of the Incentive Plan

The Incentive Award Plan will be administered by the plan administrator, who is the Combined Company Board or a committee that the Combined Company Board designates (“Committee”). The plan administrator has the power to determine, among other items, the terms of the awards granted under the Incentive Award Plan, including the exercise price, the number of shares subject to each award (and the class of shares), and the exercisability and vesting terms of the awards. The plan administrator also has the power to determine the persons to whom and the time or times at which awards will be made and to make all other determinations and take all other actions advisable for the administration of the Incentive Award Plan. All decisions made by the administrator pursuant to the provisions of the Incentive Award Plan will be final, conclusive and binding.

Participation

Participation in the Incentive Award Plan will be open to employees, non-employee directors, or consultants, who have been selected as an eligible recipient under the Incentive Award Plan by the plan administrator. Awards of incentive stock options, however, will be limited to employees of the Combined Company or its affiliates.

Types of Awards

The types of awards that may be made under the Incentive Award Plan are described below. All of the awards described below are subject to the conditions, limitations, restrictions, vesting and forfeiture provisions determined by the plan administrator, subject to the Incentive Award Plan.

Stock Options

The Incentive Award Plan provides for grants of both nonqualified and incentive stock options. A nonqualified stock option entitles the recipient to purchase our shares at a fixed exercise price. The exercise price per share will be determined by the committee but such price will never be less than 100% of the fair market value of a share of common stock on the date of grant. Fair market value will generally be the closing price of a share of common stock on NYSE on the date of grant. Nonqualified stock options under the Incentive Plan generally must be exercised within ten years from the date of grant. A nonqualified stock option is an option that does not meet the qualifications of an incentive stock option as described below.

An incentive stock option is a stock option that meets the requirements of Section 422 of the Code. Incentive stock options may be granted only to employees of the Combined Company or its affiliates and the aggregate fair market value of a share of common stock determined at the time of grant with respect to incentive stock options that are exercisable for the first time by a participant during any calendar year may not exceed \$100,000. No incentive stock option may be granted to any person who, at the time of the grant, owns or is deemed to own stock possessing more than 10% of our total combined voting power or that of any of our affiliates unless (i) the option exercise price is at least 110% of the fair market value of the stock subject to the option on the date of grant and (ii) the term of the incentive stock option does not exceed five years from the date of grant.

Unless otherwise determined by the plan administrator, each vested and outstanding option granted under the Incentive Award Plan will automatically be exercised on the last business day of the applicable option term, to the extent that, as of such date, (i) the exercise price of such option is less than the fair market value of a share, and (ii) the holder of such option remains actively in service.

Stock Appreciation Rights

A SAR entitles the holder to receive an amount equal to the difference between the fair market value of a share of common stock on the exercise date and the exercise price of the SAR (which may not be less than 100% of the fair market value of a share of our common stock on the grant date), multiplied by the number of shares of common stock subject to the SAR (as determined by the plan administrator). Unless otherwise determined by the plan administrator, each vested and outstanding SAR granted under the Incentive Award Plan will automatically be exercised on the last business day of the applicable SAR term, to the extent that, as of such date, (i) the exercise price of such SAR is less than the fair market value of a share, and (ii) the holder of such SAR remains actively in service.

Restricted Stock

A restricted stock award is an award of shares of common stock that vest in accordance with the terms and conditions established by the plan administrator. The plan administrator will determine in the award agreement whether the participant will be entitled to receive dividends on such shares of restricted stock.

Restricted Stock Units

A restricted stock unit is a right to receive shares or the cash equivalent of common stock at a specified date in the future, subject to forfeiture of such right. If the restricted stock unit has not been forfeited, then on the date specified in the restricted stock unit grant, the Combined Company must deliver to the holder of the restricted stock unit unrestricted shares of common stock (or, in the plan administrator's sole discretion, in cash equal to the shares that would otherwise be delivered, or partly in cash and partly in shares).

Other Stock-Based Awards

We may grant or sell to any participant a right or other interest that may be denominated or payable in, valued in whole or in part by reference to, or otherwise based on or related to, shares of common stock, including unrestricted common stock or a dividend equivalent. A dividend equivalent is a right to receive payments, based on dividends with respect to shares of our common stock. To the extent that an Award contains a right to receive dividends or dividend equivalents while the award remains unvested, the dividends or dividend equivalents will be accumulated and paid once and to the extent that the underlying award vests.

Other Cash-Based Awards

We may grant cash awards under the Incentive Award Plan, including cash awards as a bonus or upon the attainment of certain performance goals.

Performance-Based Awards

We may grant an Award conditioned on satisfaction of certain performance criteria. Such performance-based awards also include performance-based restricted shares and restricted stock units. Any dividends or dividend equivalents payable or credited to a participant with respect to any unvested performance-based award will be subject to the same performance goals as the shares or units underlying the performance-based award.

Performance Goals

If the plan administrator determines that an award under the Incentive Award Plan will be earned subject to the achievement of performance goals, the plan administrator may select one or more performance criteria upon which to grant award, which may include, but are not limited to, any one or more of the following: earnings before interest and taxes; earnings before interest, taxes, depreciation and amortization; net operating profit after tax; cash flow; revenue; sales; days sales outstanding; income; net income; operating income; net operating income, operating margin; earnings; earnings per share; return on equity; return on investment; return on capital; return on assets; return on net assets; total stockholder return; economic profit; market share; appreciation in the fair market value, book value or other measure of value of a share of common stock; expense/cost control; working capital; customer satisfaction; employee retention or employee turnover; employee satisfaction or engagement; environmental, health, or other safety goals; individual performance; strategic objective milestones; any other criteria specified by the plan administrator in its sole discretion; or, as applicable, any combination of, or a specified increase or decrease in, any of the foregoing.

Equitable Adjustments

In the event of a merger, consolidation, reclassification, recapitalization, spin-off, spin-out, repurchase or other reorganization or corporate transaction or event, extraordinary dividend, stock split or reverse stock split, combination or exchange of shares, or other change in corporate structure or payment of any other distribution, an equitable substitution or proportionate adjustment will be made, in each case, as may be determined by the plan administrator, in its sole discretion, in (i) the maximum number shares of common stock reserved for issuance, (ii) the kind, number and exercise price subject to outstanding options and SARs granted under the Incentive Plan; provided, however, that any such substitution or adjustment with respect to options and SARs will occur in accordance with the requirements of Code Section 409A (and with respect to incentive stock options, in compliance with the rules of Code Section 424(a)), and (iii) the kind, number and purchase price of shares subject to outstanding restricted shares or other share based Awards, in each case as may be determined by the plan administrator, in its sole discretion; provided, however, that any fractional shares resulting from the adjustment will be eliminated. In addition, the plan administrator may provide, in its sole discretion, for the cancellation of any outstanding award (i) in exchange for payment in cash or other property having an aggregate fair market value of the shares of common stock covered by the award, reduced by the aggregate exercise price or purchase price per share, if any, and (ii) with respect to any awards for which the exercise price or purchase price per share is greater than or equal to the then current fair market value per share, for no consideration.

Change in Control

The plan administrator may provide in the applicable award agreement that an award will vest on an accelerated basis upon the participant's termination of employment or service in connection with a change in control (as defined in the Incentive Award Plan) or upon the occurrence of any other event that the plan administrator may set forth in the award agreement. If the Combined Company is a party to an agreement that is reasonably likely to result in a change in control, the agreement may provide for: (i) the continuation of any award by the Combined Company, if the Combined Company is the surviving corporation; (ii) the assumption of any award by the surviving corporation or its parent or subsidiary; (iii) the substitution by the surviving corporation or its parent or subsidiary of equivalent awards for any Award, provided, however, that any such substitution with respect to options and SARs will occur in accordance with the requirements of Code Section 409A; or (iv) settlement of any award for the change in control price (less, to the extent applicable, the per share exercise or grant price), or, if the per share exercise or grant price equals or exceeds the change in control price or if the plan administrator determines that award cannot reasonably become vested pursuant to its terms, the award will terminate and be canceled without consideration.

Amendment and Termination

The plan administrator may alter, amend, or terminate the Incentive Award Plan at any time, but no amendment, alteration, or termination will be made that would adversely alter or impair the rights of a participant under any award without his or her prior written consent. Notwithstanding the foregoing, (i) approval of the Combined Company's stockholders will be obtained for any amendment that would require such approval in order to satisfy the requirements of Code Section 422, if applicable, any rules of the stock exchange on which the shares are traded or other applicable law, and (ii) without stockholder approval to the extent required by the rules of any applicable national securities exchange or inter-dealer quotation system on which the shares are listed or quoted, except as otherwise permitted under the Incentive Award Plan, (A) no amendment or modification may reduce the exercise price of any option or SAR, (B) the plan administrator may not cancel any outstanding option or SAR and replace it with a new option or SAR, another award or cash and (C) the plan administrator may not take any other action that is considered a "repricing" for purposes of the stockholder approval rules of the applicable securities exchange or inter-dealer quotation system. In addition, no modification of an award will, without the prior written consent of the participant, adversely alter or impair any rights or obligations under any award already granted under the Incentive Award Plan.

Material U.S. Federal Income Tax Consequences

The following discussion of certain relevant United States federal income tax effects applicable to certain awards granted under the Incentive Award Plan is only a summary of certain of the United States federal income tax consequences applicable to United States residents under the Incentive Award Plan, and reference is made to the Code for a complete statement of all relevant federal tax provisions. No consideration has been given to the effects of foreign, state, local and other laws (tax or other) on the Incentive Plan or on a participant, which laws will vary depending upon the particular jurisdiction or jurisdictions involved. In particular, participants who are stationed outside the United States may be subject to foreign taxes as a result of the Incentive Award Plan.

Nonqualified Stock Options

An optionee subject to United States federal income tax will generally not recognize taxable income for United States federal income tax purposes upon the grant of a nonqualified stock option. Rather, at the time of exercise of the nonqualified stock option, the optionee will recognize ordinary income, subject to wage and employment tax withholding, and the Combined Company will be entitled to a deduction, in an amount equal to the excess of the fair market value of the shares on the date of exercise over the exercise price. If the shares acquired upon the exercise of a nonqualified stock option are later sold or exchanged, then the difference between the amount received upon such sale or exchange and the fair market value of such shares on the date of such exercise will generally be taxable as long-term or short-term capital gain or loss (if the shares are a capital asset of the optionee), depending upon the length of time such shares were held by the optionee.

Incentive Stock Options

An optionee subject to United States federal income tax will generally not recognize taxable income for United States federal income tax purposes upon the grant of an incentive stock option (within the meaning of Section 422 of the Code) and the Combined Company will not be entitled to a deduction at that time. If the incentive stock option is exercised during employment or within 90 days following the termination thereof (or within one year following termination, in the case of a termination of employment due to death or disability, as such terms are defined in the Incentive Award Plan), the optionee will not recognize any income and the Combined Company will not be entitled to a deduction. The excess of the fair market value of the shares on the exercise date over the exercise price, however, is includible in computing the optionee's alternative minimum taxable income.

Generally, if an optionee disposes of shares acquired by exercising an incentive stock option either within two years after the date of grant or one year after the date of exercise, the optionee will recognize ordinary income, and the Combined Company will be entitled to a deduction, in an amount equal to the excess of the fair market value of the shares on the date of exercise (or the sale price, if lower) over the exercise price. The balance of any gain or loss will generally be treated as a capital gain or loss to the optionee. If the shares are disposed of after the two-year and one-year periods described above, the Combined Company will not be entitled to any deduction, and the entire gain or loss for the optionee will be treated as a capital gain or loss.

SARs

A participant subject to United States federal income tax who is granted a SAR will not recognize ordinary income for United States federal income tax purposes upon receipt of the SAR. At the time of exercise, however, the participant will recognize ordinary income, subject to wage and employment tax withholding, equal to the value of any cash received and the fair market value on the date of exercise of any shares received. The Combined Company will not be entitled to a deduction upon the grant of a SAR, but generally will be entitled to a deduction for the amount of income the participant recognizes upon the participant's exercise of the SAR. The participant's tax basis in any shares received will be the fair market value on the date of exercise and, if the shares are later sold or exchanged, then the difference between the amount received upon such sale or exchange and the fair market value of the shares on the date of exercise will generally be taxable as long-term or short-term capital gain or loss (if the stock is a capital asset of the participant) depending upon the length of time such shares were held by the participant.

Restricted Stock

A participant subject to United States federal income tax generally will not be taxed upon the grant of a restricted stock award, but rather will recognize ordinary income for United States federal income tax purposes in an amount equal to the fair market value of the shares at the time the restricted stock is no longer subject to a substantial risk of forfeiture (within the meaning of the Code), subject to wage and employment tax withholding. The Combined Company generally will be entitled to a deduction at the time when, and in the amount that, the participant recognizes ordinary income on account of the lapse of the restrictions. A participant's tax basis in the shares will equal his or her fair market value at the time the restrictions lapse, and the participant's holding period for capital gains purposes will begin at that time. Any cash dividends paid on the shares before the restrictions lapse will be taxable to the participant as additional compensation (and not as dividend income). Under Section 83(b) of the Code, a participant may elect to recognize ordinary income at the time the restricted shares are awarded in an amount equal to their fair market value on such grant date, subject to wage and employment tax withholding, notwithstanding the fact that such shares are

[Table of Contents](#)

subject to restrictions and a substantial risk of forfeiture. If such an election is made, no additional taxable income will be recognized by such participant at the time the restrictions lapse, the participant will have a tax basis in the restricted shares equal to their fair market value on the date of grant of their award, and the participant's holding period for capital gains purposes will begin at that time. The Combined Company generally will be entitled to a tax deduction at the time when, and to the extent that, ordinary income is recognized by such participant.

Restricted Stock Units

A participant subject to United States federal income tax who is granted a restricted stock unit will not recognize ordinary income for United States federal income tax purposes upon the receipt of the restricted stock unit, but rather will recognize ordinary income in an amount equal to the fair market value of the shares at the time the award is settled into shares, subject to wage and employment tax withholding, and the Combined Company will have a corresponding deduction at that time.

Other Stock-Based and Other Cash-Based Awards

In the case of other stock-based and other cash-based awards, depending on the form of the award, a participant subject to United States federal income tax will not be taxed upon the grant of such an award, but, rather, will recognize ordinary income for United States federal income tax purposes when such an award vests or otherwise is free of restrictions, subject to wage and employment tax withholding. In any event, the Combined Company will be entitled to a deduction at the time when, and in the amount that, a participant recognizes ordinary income.

New Plan Benefits

As of the date hereof, no awards have been granted under the Incentive Award Plan.

Future grants under the Incentive Award Plan will be made at the discretion of the plan administrator and are not yet determinable.

Equity Compensation Plan Information

The Combined Company did not maintain, or have any securities authorized for issuance under, any equity compensation plans as of December 31, 2020.

Required Vote

This Stock Plan Proposal will be approved and adopted only if holders of at least a majority of the issued and outstanding shares of common stock present in person by virtual attendance or represented by proxy and entitled to vote at the Meeting vote "FOR" the Stock Plan Proposal. **This Stock Plan Proposal is conditioned upon the approval and completion of the Business Combination Proposal, the Charter Approval Proposal, the Bylaws Proposal, and the Nasdaq Proposal. If any of the Business Combination Proposal, the Charter Approval Proposal, the Bylaws Proposal, or the Nasdaq Proposal are not approved, unless the condition is waived, this Proposal will have no effect even if approved by our stockholders.**

Board Recommendation

OUR BOARD RECOMMENDS THAT OUR STOCKHOLDERS VOTE "FOR" THE STOCK PLAN UNDER PROPOSAL 6.

PROPOSAL 7 — THE NASDAQ MERGER PROPOSAL

Overview

We are proposing the Nasdaq Merger Proposal in order to comply with Nasdaq Listing Rules 5635(a) and (b). Under Nasdaq Listing Rule 5635(a), stockholder approval is required prior to the issuance of securities in connection with the acquisition of another company if such securities are not issued in a public offering and (A) have, or will have upon issuance, voting power equal to or in excess of 20% of the voting power outstanding before the issuance of common stock (or securities convertible into or exercisable for common stock); or (B) the number of shares of common stock to be issued is or will be equal to or in excess of 20% of the number of shares of common stock outstanding before the issuance of the stock or securities. Under Nasdaq Listing Rule 5635(b), stockholder approval is required prior to the issuance of securities when the issuance or potential issuance will result in a change of control.

Pursuant to the Merger Agreement, based on Nauticus' current capitalization, we anticipate that we will issue to the Nauticus stockholders as consideration in the Business Combination, 37,531,279 shares of Common Stock (including 7,500,000 Earnout Shares). See the section entitled "*Proposal 1: The Business Combination Proposal — The Merger Agreement — Merger Consideration.*" Because the number of shares of common stock we anticipate issuing as consideration in the Business Combination (1) will constitute more than 20% of our outstanding common stock and more than 20% of outstanding voting power prior to such issuance and (2) will result in a change of control of CLAQ, we are required to obtain stockholder approval of such issuance pursuant to Nasdaq Listing Rules 5635(a) and (b).

Effect of Proposal on Current Stockholders

If the Nasdaq Merger Proposal is adopted, CLAQ would issue shares representing more than 20% of the outstanding shares of our common stock in connection with the Business Combination and the PIPE Investment. The issuance of such shares would result in significant dilution to the CLAQ stockholders and would afford such stockholders a smaller percentage interest in the voting power, liquidation value and aggregate book value of CLAQ. If the Nasdaq Merger Proposal is adopted, assuming that 37,531,279 shares of common stock are issued to the Nauticus stockholders as consideration in the Business Combination, we anticipate that the Nauticus stockholders will hold 59.1% (including the 7,500,000 Earnout Shares) of our outstanding shares of common stock, the PIPE Investors will hold 5.6% of our outstanding common stock, the current CLAQ public stockholders will hold 28.5% of our outstanding common stock and the Co-Sponsors, officers, directors and other holders of founder shares of CLAQ will hold 6.8% of our outstanding common stock immediately following completion of the Business Combination. These percentages assume that no shares of our common stock are redeemed in connection with the Business Combination, do not take into account any warrants or options to purchase our common stock that will be outstanding following the Business Combination or any equity awards that may be issued under our proposed Incentive Award Plan following the Business Combination.

If the Nasdaq Merger Proposal is not approved and we consummate the Business Combination on its current terms, CLAQ would be in violation of Nasdaq Listing Rule 5635(a) and (b) which could result in the delisting of our securities from the Nasdaq Capital Market. If Nasdaq delists our securities from trading on its exchange, we could face significant material adverse consequences, including:

- a limited availability of market quotations for our securities;
- reduced liquidity with respect to our securities;
- determination that our shares are a "penny stock," which will require brokers trading in our securities to adhere to more stringent rules, possibly resulting in a reduced level of trading activity in the secondary trading market for our securities;
- a limited amount of news and analyst coverage for the post-transaction company; and
- a decreased ability to issue additional securities or obtain additional financing in the future.

It is a condition to the obligations of CLAQ and Nauticus to close the Business Combination that our common stock remain listed on the Nasdaq Capital Market. As a result, if the Nasdaq Merger Proposal is not adopted, the Business Combination may not be completed unless this condition is waived.

Vote Required for Approval

Assuming that a quorum is present at the Meeting, the affirmative vote of holders of at least a majority of the issued and outstanding shares of common stock present in person by virtual attendance or represented by proxy and entitled to vote at the Meeting vote “FOR” the Nasdaq Merger Proposal.

This Proposal is conditioned on the approval of the Business Combination Proposal, the Charter Approval Proposal, the Bylaws Proposal, the Directors Proposal, the Stock Plan Proposal, and the Nasdaq PIPE Proposal. If any of the Business Combination Proposal, the Charter Approval Proposal, the Bylaws Proposal, the Directors Proposal, the Stock Plan Proposal or the Nasdaq PIPE Proposal is not approved, unless the condition is waived, Proposal 7 will have no effect even if approved by our stockholders. **Because stockholder approval of this Proposal 7 is a condition to completion of the Business Combination under the Merger Agreement, if this Proposal 7 is not approved by our stockholders, the Business Combination will not occur unless we and Nauticus waive the applicable closing condition.**

Board Recommendation

OUR BOARD RECOMMENDS THAT OUR STOCKHOLDERS VOTE “FOR” THE NASDAQ MERGER PROPOSAL UNDER PROPOSAL 7.

PROPOSAL 8 — THE NASDAQ PIPE PROPOSAL

Overview

We are proposing the Nasdaq PIPE Proposal in order to comply with Nasdaq Listing Rules 5635(d). Under Nasdaq Listing Rule 5635(d), stockholder approval is required for a transaction other than a public offering involving the sale, issuance or potential issuance by an issuer of common stock (or securities convertible into or exercisable for common stock) at a price that is less than the lower of (i) the closing price immediately preceding the signing of the binding agreement or (ii) the average closing price of the common stock for the five trading days immediately preceding the signing of the binding agreement, if the number of shares of common stock (or securities convertible into or exercisable for common stock) to be issued equals to 20% or more of the common stock, or 20% or more of the voting power, outstanding before the issuance.

In connection with the Business Combination, there will be a PIPE Investment consisting of the Equity Financing of \$35.3 million sale of common stock and Debt Financing of up to \$40.0 million of Debentures and associated warrants. The Equity Financing will result in the sale and issuance of 3,530,000 shares of common stock at \$10.00 per share. The number of shares of common stock into which the Debentures are convertible equals to 120% of the outstanding principal amount of the Debentures divided by the conversion price of \$15.00, and the number of shares of common stock into which the associated warrants are exercisable is equal to 120% of the outstanding principal amount of the Debentures divided by the conversion price, with an exercise price equal to \$20, subject to adjustment. The exercise price of the associated warrant will be subject to (i) customary anti-dilution adjustments; and (ii) in the case of a subsequent equity sale at a per share price below the exercise price, the exercise price of the associated warrant will be adjusted to such lower price, and the number of shares underlying the warrant will increase proportionately. In the event of a rights offering or dividend, the warrant holder will be treated as though the shares underlying the warrant he/she holds were outstanding. These warrants can be exercised on a cashless basis. Assuming that the full amount of \$40.0 million of Debentures are sold, 3,200,000 shares of common stock will be issuable upon conversion of the Debentures, and an additional 3,200,000 shares of common stock will be issuable upon exercise of the associated warrants sold in the Debt Financing. The obligations to close the Debt Financing are conditioned upon, among other things, (i) raising \$25,000,000 in equity financing from strategic investors, (ii) hiring a chief financial officer with public company experience, and (iii) the consummation of the transactions contemplated by the Merger Agreement. The Equity Financing will satisfy the closing condition related to the equity financing requirement for the Debt Financing, and the PIPE Investment alone will satisfy the Minimum Cash Condition under the Merger Agreement.

Because the shares of common stock to be issued or issuable, as applicable, in connection with the PIPE Investment (1) was at a price that is less than the lower of (i) the closing price immediately preceding the signing of the binding agreement or (ii) the average closing price of the common stock for the five trading days immediately preceding the signing of the binding agreement, and (2) will constitute more than 20% of CLAQ's outstanding common stock and more than 20% of outstanding voting power prior to such issuance, CLAQ is required to obtain stockholder approval of such issuance pursuant to Nasdaq Listing Rule 5635(d).

Effect of Proposal on Current Stockholders

If the Nasdaq PIPE Proposal is adopted, CLAQ would issue securities convertible into more than 20% of the outstanding shares of our common stock in connection with the PIPE Investment. The issuance of such shares would result in significant dilution to the CLAQ stockholders and would afford such stockholders a smaller percentage interest in the voting power, liquidation value and aggregate book value of CLAQ. If the Nasdaq PIPE Proposal is adopted, 3,530,000 shares of common stock will be issued in connection with the Equity Financing, and up to a total of 6,400,000 shares of common stock will be issuable upon conversion of up to the \$40.0 million of Debentures and exercise of associated warrants sold in connection with the Debt Financing. As of the date of this proxy statement/prospectus, ATW is the lead purchaser and has subscribed for Debentures in the aggregate principal amount of \$37,959,184 which is convertible into 3,036,735 shares of the Combined Company's common stock and associated warrants for an additional 3,036,735 shares of the common stock. Immediately following the completion of the Business Combination and the PIPE Investment, we anticipate that the Nauticus stockholders will hold 59.1% (including the 7,500,000 Earnout Shares) of our outstanding shares of common stock, the PIPE Investors will hold 5.6% of our outstanding common stock, the current CLAQ public stockholders will hold 28.5% of our outstanding common stock and the Co-Sponsors, officers, directors and other holders of founder shares of CLAQ will hold 6.8% of our outstanding common stock. These percentages assume that no shares of our common stock

[Table of Contents](#)

are redeemed in connection with the Business Combination, do not take into account any warrants or options to purchase our common stock that will be outstanding following the Business Combination or any equity awards that may be issued under our proposed Incentive Award Plan following the Business Combination.

If the Nasdaq PIPE Proposal is not approved and we consummate the Business Combination on its current terms, CLAQ would be in violation of Nasdaq Listing Rule 5635(d) which could result in the delisting of our securities from the Nasdaq Capital Market. If Nasdaq delists our securities from trading on its exchange, we could face significant material adverse consequences, including:

- a limited availability of market quotations for our securities;
- reduced liquidity with respect to our securities;
- determination that our shares are a “penny stock,” which will require brokers trading in our securities to adhere to more stringent rules, possibly resulting in a reduced level of trading activity in the secondary trading market for our securities;
- a limited amount of news and analyst coverage for the post-transaction company; and
- a decreased ability to issue additional securities or obtain additional financing in the future.

It is a condition to the obligations of CLAQ and Nauticus to close the Business Combination that our common stock remain listed on the Nasdaq Capital Market. As a result, if the Nasdaq PIPE Proposal is not adopted, the Business Combination may not be completed unless this condition is waived.

Vote Required for Approval

Assuming that a quorum is present at the Meeting, the affirmative vote of holders of at least a majority of the issued and outstanding shares of common stock present in person by virtual attendance or represented by proxy and entitled to vote at the Meeting vote “FOR” the Nasdaq PIPE Proposal.

This Proposal is conditioned on the approval of the Business Combination Proposal, the Charter Approval Proposal, the Bylaws Proposal, the Directors Proposal, the Stock Plan Proposal and the Nasdaq Merger Proposal. If any of the Business Combination Proposal, the Charter Approval Proposal, the Bylaws Proposal, the Directors Proposal, the Stock Plan Proposal or the Nasdaq Merger Proposal is not approved, unless the condition is waived, Proposal 8 will have no effect even if approved by our stockholders. **Because stockholder approval of this Proposal 8 is a condition to completion of the Business Combination under the Merger Agreement, if this Proposal 8 is not approved by our stockholders, the Business Combination will not occur unless we and Nauticus waive the applicable closing condition.**

Board Recommendation

OUR BOARD RECOMMENDS THAT OUR STOCKHOLDERS VOTE “FOR” THE NASDAQ PIPE PROPOSAL UNDER PROPOSAL 8.

PROPOSAL 9 — THE ADJOURNMENT PROPOSAL

The Adjournment Proposal, if adopted, will approve the chairman's adjournment of the Meeting to a later date to permit further solicitation of proxies. The Adjournment Proposal will only be presented to our stockholders in the event, based on the tabulated votes, there are not sufficient votes received at the time of the Meeting to approve the other Proposals.

Consequences if the Adjournment Proposal is Not Approved

If the Adjournment Proposal is not approved by our stockholders, the chairman will not adjourn the Meeting to a later date in the event, based on the tabulated votes, there are not sufficient votes received at the time of the Meeting to approve the Business Combination Proposal, the Charter Approval Proposal, the Bylaws Proposal, the Directors Proposal, the Stock Plan Proposal, the Nasdaq Merger Proposal or the Nasdaq PIPE Proposal.

Required Vote

This Adjournment Proposal will be approved and adopted only if holders of at least a majority of the issued and outstanding shares of common stock present in person by virtual attendance or represented by proxy and entitled to vote at the Meeting vote "FOR" the Adjournment Proposal. The Adjournment Proposal is not conditioned on the approval of any other Proposal set forth in this proxy statement.

Board Recommendation

THE BOARD RECOMMENDS A VOTE "FOR" ADOPTION OF THE ADJOURNMENT PROPOSAL UNDER PROPOSAL 9.

MATERIAL U.S. FEDERAL INCOME TAX CONSEQUENCES

It is the opinion of Winston & Strawn LLP that the Merger will qualify as a “reorganization” for U.S. federal income tax purposes within the meaning of Section 368(a) of the Code. This opinion is based on facts and representations contained in representation letters provided by CLAQ, Merger Sub and Nauticus and on customary factual assumptions, and further assumes that any consideration paid in respect of Dissenting Shares (as such term is defined in the Merger Agreement) will not exceed 10% of the total value of all consideration paid to holders of Nauticus Common Stock and the Merger is completed in the manner set forth in the Merger Agreement and the Registration Statement on Form S-4 of which this proxy statement/prospectus forms a part. If any assumption or representation is or becomes inaccurate, the U.S. federal income tax consequences of the Merger could be adversely affected. In addition, neither the obligation of CLAQ nor the obligation of Nauticus to complete the merger is conditioned upon the receipt of an opinion from counsel confirming whether the Merger will so qualify.

While the parties intend for the transaction to qualify as a “reorganization” within the meaning of Section 368(a) of the Internal Revenue Code, there is no assurance that will indeed be the case. In the event that the transaction fails to qualify as such, there would be no adverse tax consequences to CLAQ or Merger Sub.

The following is a general discussion of the material U.S. federal income tax consequences of the exercise of redemption rights by U.S. Holders and Non-U.S. Holders (defined below) of common stock.

This discussion is based on provisions of the Code, the Treasury Regulations promulgated thereunder (whether final, temporary, or proposed), administrative rulings of the IRS, and judicial decisions, all as in effect on the date hereof, and all of which are subject to differing interpretations or change, possibly with retroactive effect. This discussion does not purport to be a complete analysis or listing of all potential U.S. federal income tax consequences that may apply to a holder as a result of an exercise of redemption rights. In addition, this discussion does not address all aspects of U.S. federal income taxation that may be relevant to particular holders nor does it take into account the individual facts and circumstances of any particular holder that may affect the U.S. federal income tax consequences to such holder, and accordingly, is not intended to be, and should not be construed as, tax advice. This discussion does not address the U.S. federal 3.8% Medicare tax imposed on certain net investment income or any aspects of U.S. federal taxation other than those pertaining to the income tax, nor does it address any tax consequences arising under any U.S. state and local, or non-U.S. tax laws. Holders should consult their own tax advisors regarding such tax consequences in light of their particular circumstances.

No ruling has been requested or will be obtained from the IRS regarding the U.S. federal income tax consequences of an exercise of redemption rights, the Business Combination or any other related matter; thus, there can be no assurance that the IRS will not challenge the U.S. federal income tax treatment described below or that, if challenged, such treatment will be sustained by a court.

This summary is limited to considerations relevant to holders that hold common stock as “capital assets” within the meaning of section 1221 of the Code (generally, property held for investment). This discussion does not address all aspects of U.S. federal income taxation that may be important to holders in light of their individual circumstances, including holders subject to special treatment under the U.S. tax laws, such as, for example:

- banks or other financial institutions, underwriters, or insurance companies;
- traders in securities who elect to apply a mark-to-market method of accounting;
- real estate investment trusts and regulated investment companies;
- tax-exempt organizations, qualified retirement plans, individual retirement accounts, or other tax-deferred accounts;
- expatriates or former long-term residents of the United States;
- subchapter S corporations, partnerships or other pass-through entities or investors in such entities;
- dealers or traders in securities, commodities or currencies;
- grantor trusts;
- persons subject to the alternative minimum tax;

Table of Contents

- U.S. persons whose “functional currency” is not the U.S. dollar;
- persons who received shares of common stock through the issuance of restricted stock under an equity incentive plan or through a tax-qualified retirement plan or otherwise as compensation;
- persons who own (directly or through attribution) 5% or more (by vote or value) of the outstanding shares of common stock (excluding treasury shares);
- holders holding common stock as a position in a “straddle,” as part of a “synthetic security” or “hedge,” as part of a “conversion transaction,” or other integrated investment or risk reduction transaction;
- controlled foreign corporations, passive foreign investment companies, or foreign corporations with respect to which there are one or more United States shareholders within the meaning of Treasury Regulation Section 1.367(b)-3(b)(1)(ii); or
- the Sponsor or its affiliates.

As used in this proxy statement/prospectus, the term “U.S. Holder” means a beneficial owner of common stock that is, for U.S. federal income tax purposes:

- an individual who is a citizen or resident of the United States;
- a corporation (or other entity that is classified as a corporation for U.S. federal income tax purposes) that is created or organized in or under the laws of the United States or any State thereof or the District of Columbia;
- an estate the income of which is subject to U.S. federal income tax regardless of its source; or
- a trust (i) if a court within the United States is able to exercise primary supervision over the administration of the trust and one or more U.S. persons have the authority to control all substantial decisions of the trust, or (ii) that has a valid election in effect under applicable Treasury Regulations to be treated as a U.S. person for U.S. federal income tax purposes.

A “Non-U.S. Holder” means a beneficial owner of common stock that is neither a U.S. Holder nor a partnership (or an entity or arrangement treated as a partnership) for U.S. federal income tax purposes.

If a partnership, including for this purpose any entity or arrangement that is treated as a partnership for U.S. federal income tax purposes, holds common stock, the U.S. federal income tax treatment of a partner in such partnership will generally depend on the status of the partner and the activities of the partnership. A holder that is a partnership and the partners in such partnership should consult their own tax advisors with regard to the U.S. federal income tax consequences of an exercise of redemption rights.

THIS SUMMARY DOES NOT PURPORT TO BE A COMPREHENSIVE ANALYSIS OR DESCRIPTION OF ALL POTENTIAL U.S. FEDERAL INCOME TAX CONSEQUENCES OF AN EXERCISE OF REDEMPTION RIGHTS. IN ADDITION, THE U.S. FEDERAL INCOME TAX TREATMENT OF THE BENEFICIAL OWNERS OF COMMON STOCK MAY BE AFFECTED BY MATTERS NOT DISCUSSED HEREIN AND DEPENDS IN SOME INSTANCES ON DETERMINATIONS OF FACT AND INTERPRETATIONS OF COMPLEX PROVISIONS OF U.S. FEDERAL INCOME TAX LAW FOR WHICH NO CLEAR PRECEDENT OR AUTHORITY MAY BE AVAILABLE. HOLDERS OF NAUTICUS COMMON STOCK SHOULD CONSULT WITH THEIR TAX ADVISORS REGARDING THE PARTICULAR TAX CONSEQUENCES TO THEM OF THE BUSINESS COMBINATION, INCLUDING THE APPLICABILITY AND EFFECTS OF U.S. FEDERAL, STATE, LOCAL, AND OTHER TAX LAWS.

Certain Material U.S. Federal Income Tax Consequences of Exercising Redemption Rights

U.S. Federal Income Tax Consequences to U.S. Holders

In the event that a U.S. Holder elects to redeem its common stock for cash, the treatment of the transaction for U.S. federal income tax purposes will depend on whether the redemption qualifies as a sale or exchange of the common stock under Section 302 of the Code or is treated as a corporate distribution under Section 301 of the Code with respect to the U.S. Holder. If the redemption qualifies as a sale or exchange of the common stock, the U.S. Holder will be

treated as recognizing capital gain or loss equal to the difference between the amount realized on the redemption and such U.S. Holder's adjusted tax basis in common stock surrendered in such redemption transaction. Any such capital gain or loss generally will be long-term capital gain or loss if the U.S. Holder's holding period for the common stock redeemed exceeds one year. It is unclear, however, whether the redemption rights with respect to the common stock may suspend the running of the applicable holding period for this purpose. Long term capital gain realized by a non-corporate U.S. Holder is currently taxed at a reduced rate. The deductibility of capital losses is subject to limitations.

If the redemption does not qualify as a sale or exchange of common stock, the U.S. Holder will be treated as receiving a corporate distribution. Such distributions generally will constitute dividends for U.S. federal income tax purposes to the extent paid from CLAQ's current or accumulated earnings and profits, as determined under U.S. federal income tax principles. Distributions in excess of current and accumulated earnings and profits will constitute a return of capital that will be applied against and reduce (but not below zero) the U.S. Holder's adjusted tax basis in the common stock. Any remaining excess will be treated as gain realized on the sale or other disposition of the common stock. Dividends paid to a U.S. Holder that is a taxable corporation generally will qualify for the dividends received deduction if the requisite holding period is satisfied. With certain exceptions (including, but not limited to, dividends treated as investment income for purposes of investment interest deduction limitations) and provided certain holding period requirements are met, dividends paid to a non-corporate U.S. Holder generally will constitute "qualified dividends" that will be subject to tax at the maximum tax rate accorded to long-term capital gains. However, it is unclear whether the redemption rights with respect to the common stock may prevent a U.S. Holder from satisfying the applicable holding period requirements with respect to the dividends received deduction or the preferential tax rate on qualified dividend income, as the case may be.

Whether a redemption qualifies for sale or exchange treatment will depend largely on the total number of shares of common stock treated as held by the U.S. Holder (including any common stock constructively owned by the U.S. Holder as a result of owning CLAQ Warrants) relative to all of the shares of common stock outstanding both before and after the redemption. The redemption of common stock generally will be treated as a sale or exchange of the common stock (rather than as a corporate distribution) if the redemption (i) is "substantially disproportionate" with respect to the U.S. Holder, (ii) results in a "complete termination" of the U.S. Holder's interest in CLAQ or (iii) is "not essentially equivalent to a dividend" with respect to the U.S. Holder. These tests are explained more fully below.

In determining whether any of the foregoing tests are satisfied, a U.S. Holder takes into account not only common stock actually owned by the U.S. Holder, but also shares of common stock that are constructively owned by it. A U.S. Holder may constructively own, in addition to stock owned directly, stock owned by certain related individuals and entities in which the U.S. Holder has an interest or that have an interest in such U.S. Holder, as well as any stock the U.S. Holder has a right to acquire by exercise of an option, which would generally include common stock which could be acquired pursuant to the exercise of CLAQ Warrants. In order to meet the substantially disproportionate test, (i) the percentage of our outstanding voting stock actually and constructively owned by the U.S. Holder immediately following the redemption of common stock must be less than 80% of the percentage of our outstanding voting stock actually and constructively owned by the U.S. Holder immediately before the redemption, (ii) the U.S. Holder's percentage ownership (including constructive ownership) of our outstanding stock (both voting and nonvoting) immediately after the redemption must be less than 80% of such percentage ownership (including constructive ownership) immediately before the redemption; and (iii) the U.S. Holder must own (including constructive ownership), immediately after the redemption, less than 50% of the total combined voting power of all classes of our stock entitled to vote. There will be a complete termination of a U.S. Holder's interest if either (i) all of the shares of the common stock actually and constructively owned by the U.S. Holder are redeemed or (ii) all of the shares of the common stock actually owned by the U.S. Holder are redeemed and the U.S. Holder is eligible to waive, and effectively waives in accordance with specific rules, the attribution of stock owned by certain family members and the U.S. Holder does not constructively own any other common stock. The redemption of the common stock will not be essentially equivalent to a dividend if a U.S. Holder's redemption results in a "meaningful reduction" of the U.S. Holder's proportionate interest in CLAQ. Whether the redemption will result in a meaningful reduction in a U.S. Holder's proportionate interest in CLAQ will depend on the particular facts and circumstances. However, the IRS has indicated in a published ruling that even a small reduction in the proportionate interest of a small minority stockholder in a publicly held corporation who exercises no control over corporate affairs may constitute such a "meaningful reduction." A U.S. Holder should consult with its own tax advisors as to the tax consequences of a redemption.

[Table of Contents](#)

If none of the foregoing tests is satisfied, then the redemption will be treated as a corporate distribution. After the application of those rules regarding corporate distributions, any remaining tax basis of the U.S. Holder in the redeemed common stock will be added to the U.S. Holder's adjusted tax basis in its remaining common stock, or, if it has none, to the U.S. Holder's adjusted tax basis in its CLAQ Warrants or possibly in other common stock constructively owned by it.

U.S. Federal Income Tax Consequences to Non-U.S. Holders

The characterization for U.S. federal income tax purposes of the redemption of a Non-U.S. Holder's common stock as a sale or exchange under Section 302 of the Code or as a corporate distribution under Section 301 of the Code generally will correspond to the U.S. federal income tax characterization of such a redemption of a U.S. Holder's common stock, as described above, and the corresponding consequences will be as described below.

Redemption Treated as Sale or Exchange

Any gain realized by a Non-U.S. Holder on the redemption of common stock that is treated as a sale or exchange under Section 302 of the Code generally will not be subject to U.S. federal income tax unless:

- the gain is effectively connected with a trade or business of the Non-U.S. Holder in the United States (and, if required by an applicable income tax treaty, is attributable to a United States permanent establishment or fixed base of the Non-U.S. Holder);
- the Non-U.S. Holder is an individual who is present in the United States for a period or periods aggregating 183 days or more in the taxable year of the disposition, and certain other conditions are met; or
- we are or have been a "United States real property holding corporation" for U.S. federal income tax purposes at any time during the shorter of the five-year period ending on the date of disposition or the Non-U.S. Holder's holding period for such common stock redeemed, and either (A) shares of common stock are not considered to be regularly traded on an established securities market or (B) such Non-U.S. Holder has owned or is deemed to have owned, at any time during the shorter of the five-year period preceding such disposition and such Non-U.S. Holder's holding period more than 5% of the outstanding shares of common stock. There can be no assurance that shares of common stock will be treated as regularly traded on an established securities market for this purpose.

A non-corporate Non-U.S. Holder described in the first bullet point immediately above will be subject to tax on the net gain derived from the sale under regular graduated U.S. federal income tax rates. An individual Non-U.S. Holder described in the second bullet point immediately above will be subject to a flat 30% tax on the gain derived from the sale, which may be offset by certain United States source capital losses, even though the individual is not considered a resident of the United States, provided that the individual has timely filed U.S. federal income tax returns with respect to such losses. If a Non-U.S. Holder that is a corporation falls under the first bullet point immediately above, it will be subject to tax on its net gain in the same manner as if it were a United States person as defined under the Code and, in addition, may be subject to the branch profits tax equal to 30% (or such lower rate as may be specified by an applicable income tax treaty) of its effectively connected earnings and profits, subject to adjustments.

If the last bullet point immediately above applies to a Non-U.S. Holder, gain recognized by such Non-U.S. Holder on the redemption of common stock generally will be subject to tax at generally applicable U.S. federal income tax rates. In addition, we may be required to withhold U.S. income tax at a rate of 15% of the amount realized upon such redemption. We would generally be classified as a "U.S. real property holding corporation" if the fair market value of our "United States real property interests" equals or exceeds 50% of the sum of the fair market value of our worldwide real property interests and our other assets used or held for use in a trade or business, as determined for U.S. federal income tax purposes. However, we believe that we are not and have not been at any time since our formation a U.S. real property holding corporation and we do not expect to be a U.S. real property holding corporation immediately after the Business Combination is completed.

Redemption Treated as Corporate Distribution

With respect to any redemption treated as a corporate distribution under Section 301 of the Code, provided such dividends are not effectively connected with the Non-U.S. Holder's conduct of a trade or business within the United States, CLAQ will be required to withhold U.S. tax from the gross amount of the dividend at a rate of

[Table of Contents](#)

30%, unless such Non-U.S. Holder is eligible for a reduced rate of withholding tax under an applicable income tax treaty and provides proper certification of its eligibility for such reduced rate (usually on an IRS Form W-8BEN or W-8BEN-E). Any distribution not constituting a dividend will be treated first as reducing (but not below zero) the Non-U.S. Holder's adjusted tax basis in its shares of the common stock and, to the extent such distribution exceeds the Non-U.S. Holder's adjusted tax basis, as gain realized from the sale or other disposition of the Common Stock, which will be treated as described above.

This withholding tax does not apply to dividends paid to a Non-U.S. Holder who provides a Form W-8ECI, certifying that the dividends are effectively connected with the Non-U.S. Holder's conduct of a trade or business within the United States. Instead, the effectively connected dividends will be subject to regular U.S. income tax as if the Non-U.S. Holder were a U.S. resident, subject to an applicable income tax treaty providing otherwise. A Non-U.S. corporation receiving effectively connected dividends may also be subject to an additional "branch profits tax" imposed at a rate of 30% (or a lower treaty rate).

Information Reporting and Backup Withholding

Payments of cash to a holder pursuant to a redemption of common stock may be subject to information reporting to the IRS and possible U.S. backup withholding. Backup withholding will not apply, however, to a U.S. Holder who furnishes a correct taxpayer identification number and makes other required certifications, or who is otherwise exempt from backup withholding and establishes such exempt status. A Non-U.S. Holder generally will eliminate the requirement for information reporting and backup withholding by providing certification of its foreign status, under penalties of perjury, on a duly executed applicable IRS Form W-8 or by otherwise establishing an exemption.

Backup withholding is not an additional tax. Amounts withheld as backup withholding may be credited against a holder's U.S. federal income tax liability, and a holder generally may obtain a refund of any excess amounts withheld under the backup withholding rules by timely filing the appropriate claim for refund with the IRS and furnishing any required information.

FATCA Withholding Taxes

Provisions under the Foreign Account Tax Compliance Act, commonly referred to as "FATCA," impose withholding of thirty percent (30%) on payments of dividends (including amounts treated as dividends received pursuant to a redemption of stock) on common stock. Thirty percent (30%) withholding under FATCA was scheduled to apply to the gross proceeds of a disposition of any stock, debt instrument, or other property that can produce U.S.-source dividends or interest beginning on January 1, 2019, but on December 13, 2018, the IRS released proposed regulations that, if finalized in their proposed form, would eliminate the obligation to withhold on gross proceeds. Although these proposed Treasury Regulations are not final, taxpayers generally may rely on them until final Treasury Regulations are issued.

In general, no such withholding will be required with respect to a U.S. Holder or an individual Non-U.S. Holder that timely provides certifications required on a valid IRS Form W-9 or a valid IRS Form W-8, respectively. Holders potentially subject to withholding include "foreign financial institutions" (which is broadly defined for this purpose and in general includes investment vehicles) and certain other non-U.S. entities unless various U.S. information reporting and due diligence requirements (generally relating to ownership by U.S. persons of interests in or accounts with those entities) have been satisfied, or an exemption applies (typically certified as to by the delivery of a properly completed IRS Form W-8). If FATCA withholding is imposed, a beneficial owner that is not a foreign financial institution generally will be entitled to a refund of any amounts withheld by filing a U.S. federal income tax return. Foreign financial institutions located in jurisdictions that have an intergovernmental agreement with the United States governing FATCA may be subject to different rules. All holders should consult their tax advisors regarding the effects of FATCA on a redemption of common stock.

CLAQ'S BUSINESS

Overview

CLAQ was incorporated in Delaware on June 18, 2020 and was formed for the purpose of entering into a merger, share exchange, asset acquisition, stock purchase, recapitalization, reorganization or other similar Business Combination with one or more businesses or entities. CLAQ has until July 19, 2022 to consummate a Business Combination. If CLAQ is unable to complete its initial business combination within such 12-month period, it will (i) cease all operations except for the purpose of winding up (ii) as promptly as reasonably possible but not more than ten business days thereafter, redeem 100% of the outstanding public shares and (iii) as promptly as reasonably possible following such redemption, subject to the approval of our remaining stockholders and our board of directors, dissolve and liquidate, subject (in the case of (ii) and (iii) above) to our obligations under Delaware law to provide for claims of creditors and the requirements of other applicable law. However, if we anticipate that we may not be able to consummate our initial business combination within 12 months, our initial stockholders or their affiliates may, but are not obligated to, extend the period of time to consummate an initial business combination two times by an additional three months each time (for a total of up to 18 months to complete an initial business combination) without the need for a separate stockholder vote. Pursuant to the terms of our amended and restated certificate of incorporation and the trust agreement between us and Continental Stock Transfer & Trust Company, the only way to extend the time available for us to consummate our initial business combination without the need for a separate stockholder vote is for our initial stockholders or their affiliates or designees, upon five days' advance notice prior to the applicable deadline, to deposit into the trust account \$1,725,000 (\$0.10 per public share, or an aggregate of \$3,450,000) if extended for each of the full three months), on or prior to the date of the applicable deadline. Pursuant to our amended and restated certificate of incorporation and the trust agreement, if such funds are not deposited, the time to complete an initial business combination cannot be extended unless our stockholders otherwise approve an extension on different terms. In the event that they elected to extend the time to complete our initial business combination and deposited the applicable amount of money into trust, the initial stockholders would receive a non-interest bearing, unsecured promissory note equal to the amount of any such deposit that will not be repaid in the event that we are unable to close a business combination unless there are funds available outside the trust account to do so. Such note would be paid upon consummation of our initial business combination. There will be no redemption rights or liquidating distributions with respect to our rights or warrants, which will expire worthless if we fail to complete our business combination within the time period.

If we are unable to consummate an initial business combination and are forced to redeem 100% of our outstanding public shares for a portion of the funds held in the trust account, we anticipate notifying the trustee of the trust account to begin liquidating such assets promptly after such date, and anticipate it will take no more than 10 business days to effectuate the redemption of our public shares. Our insiders have waived their rights to participate in any redemption with respect to their founder shares. We will pay the costs of any subsequent liquidation from our remaining assets outside of the trust account. If such funds are insufficient, our insiders have agreed to pay the funds necessary to complete such liquidation (currently anticipated to be no more than approximately \$50,000), and have agreed not to seek repayment of such expenses. Each holder of public shares will receive a pro rata portion of the amount then in the trust account, plus any pro rata interest earned on the funds held in the trust account and not previously released to us or necessary to pay our taxes. The proceeds deposited in the trust account could, however, become subject to claims of our creditors that are in preference to the claims of public stockholders.

Trust Account

Following the closing of the IPO on July 19, 2021 and the underwriters' full exercise of over-allotment option on July 28, 2021, \$174,500,000 from the net proceeds of the sale of the Public Units in the IPO and the sale of the Private Warrants was placed in a trust account maintained by Continental Stock Transfer & Trust Company, acting as trustee (the "Trust Account"). The funds held in the Trust Account is and will be invested only in United States "government securities" within the meaning of Section 2(a)(16) of the Investment Company Act having a maturity of 185 days or less or in money market funds meeting certain conditions under Rule 2a-7 promulgated under the Investment Company Act which invest only in direct U.S. government treasury obligations, so that CLAQ is not deemed to be an investment company under the Investment Company Act, except with respect to interest earned on the funds held in the Trust Account that may be released to CLAQ to pay its income or other tax obligations, the proceeds will not be released from the Trust Account until the earlier of the completion of a Business Combination or the redemption of

100% of the outstanding Public Common Stock if CLAQ has not completed a Business Combination in the required time period. The proceeds held in the Trust Account may be used as consideration to pay the sellers of a target business with which CLAQ completes a Business Combination. Any amounts not paid as consideration to the sellers of the target business may be used to finance operations of the target business.

Business Combination Activities

On December 16, 2021, we entered into the Merger Agreement. As a result of the transaction, Nauticus will become our wholly owned subsidiary, and we will change our name to “Nauticus Robotics, Inc.” In the event that the Business Combination is not consummated by July 19, 2022 (unless extended), our corporate existence will cease and we will distribute the proceeds held in the Trust Account to our public stockholders.

Redemption Rights

Our stockholders (except the Initial Stockholders) will be entitled to redeem their Public Common Stock for a pro rata share of the Trust Account (currently anticipated to be no less than approximately \$10.10 per share) net of taxes payable. The Initial Stockholders do not have redemption rights with respect to any Common Stock owned by them, directly or indirectly.

Automatic Dissolution and Subsequent Liquidation of Trust Account if No Business Combination

If CLAQ does not complete a business combination within 12 months from the consummation of the IPO (unless such time period has been extended as described herein), it will trigger the automatic winding up, dissolution and liquidation pursuant to the terms of our Certificate of Incorporation. As a result, this has the same effect as if CLAQ had formally gone through a voluntary liquidation procedure under Delaware law. Accordingly, no vote would be required from CLAQ’s stockholders to commence such a voluntary winding up, dissolution and liquidation. If CLAQ is unable to consummate its initial business combination within such time period, it will, as promptly as possible but not more than ten business days thereafter, redeem 100% of CLAQ’s outstanding Public Common Stock for a pro rata portion of the funds held in the Trust Account, including a pro rata portion of any interest earned on the funds held in the Trust Account and not necessary to pay its taxes, and then seek to liquidate and dissolve. Public stockholders will also forfeit the one-quarter of one Warrant included in the Public Common Stock being redeemed.

The proceeds deposited in the Trust Account could, however, become subject to claims of our creditors that are in preference to the claims of our public stockholders. Although CLAQ will seek to have all vendors, service providers (excluding our independent registered public accounting firm), prospective target businesses and other entities with which we do business execute agreements with us waiving any right, title, interest or claim of any kind in or to any monies held in the Trust Account for the benefit of our public stockholders, there is no guarantee that they will execute such agreements or even if they execute such agreements that they would be prevented from bringing claims against the Trust Account including, but not limited to, fraudulent inducement, breach of fiduciary responsibility or other similar claims, as well as claims challenging the enforceability of the waiver, in each case in order to gain an advantage with respect to a claim against our assets, including the funds held in the Trust Account. If any third party refuses to execute an agreement waiving such claims to the monies held in the Trust Account, CLAQ will perform an analysis of the alternatives available to it and will only enter into an agreement with a third-party that has not executed a waiver if management believes that such third-party’s engagement would be significantly more beneficial to us than any alternative. Examples of possible instances where we may engage a third party that refuses to execute a waiver include the engagement of a third-party consultant whose particular expertise or skills are believed by management to be significantly superior to those of other consultants that would agree to execute a waiver or in cases where management is unable to find a service provider willing to execute a waiver.

If we are forced to file a bankruptcy case or an involuntary bankruptcy case is filed against us which is not dismissed, the proceeds held in the trust account could be subject to applicable bankruptcy law, and may be included in our bankruptcy estate and subject to the claims of third parties with priority over the claims of our stockholders. To the extent any bankruptcy claims deplete the trust account, the per share redemption or conversion amount received by public stockholders may be less than \$10.10.

[Table of Contents](#)

If, after we distribute the proceeds in the trust account to our public stockholders, we file a bankruptcy petition or an involuntary bankruptcy petition is filed against us that is not dismissed, any distributions received by stockholders could be viewed under applicable debtor/creditor and/or bankruptcy laws as either a “preferential transfer” or a “fraudulent conveyance.” As a result, a bankruptcy court could seek to recover all amounts received by our stockholders. In addition, our board of directors may be viewed as having breached its fiduciary duty to our creditors and/or having acted in bad faith, thereby exposing itself and us to claims of punitive damages, by paying public stockholders from the trust account prior to addressing the claims of creditors. Claims may be brought against us for these reasons.

Each of the Co-Sponsors has agreed to waive its rights to participate in any liquidation of the Trust Account or other assets with respect to the Private Warrants they hold.

Facilities

CLAQ pays Chardan, an affiliate of CleanTech Investments, a fee of \$10,000 per month for use of office space and certain office and secretarial services. CLAQ maintains its principal executive offices at 207 West 25th Street, 9th Floor, New York, NY 10001.

Employees

CLAQ has four executive officers. These individuals are not obligated to devote any specific number of hours to its matters and intend to devote only as much time as they deem necessary to its affairs until we have completed our initial business combination. CLAQ presently expects its executive officers to devote such amount of time as they reasonably believe is necessary to our business (which could range from only a few hours a week while CLAQ is trying to locate a potential target business to significantly more time as it moves into serious negotiations with a target business for a business combination). CLAQ does not intend to have any full-time employees prior to the consummation of a business combination.

MANAGEMENT'S DISCUSSION AND ANALYSIS OF FINANCIAL CONDITION AND RESULTS OF OPERATIONS OF CLAQ

The following discussion and analysis of the CLAQ's financial condition and results of operations should be read in conjunction with our audited financial statements and the notes related thereto which are included elsewhere in this proxy statement/prospectus. Certain information contained in the discussion and analysis set forth below includes forward-looking statements. Our actual results may differ materially from those anticipated in these forward-looking statements as a result of many factors, including those set forth under "Cautionary Note Regarding Forward-Looking Statements."

CLAQ is a blank check company incorporated on June 18, 2020 as a Delaware corporation and formed for the purpose of effectuating a merger, capital stock exchange, asset acquisition, stock purchase, reorganization or similar business combination with one or more businesses. CLAQ intends to effectuate its initial business combination using cash from the proceeds of its IPO and the private placement of its Private Warrants, the proceeds of the sale of its shares in connection with its initial business combination (pursuant to forward purchase agreements or backstop agreements it may enter into following the consummation of the IPO or otherwise), shares issued to the owners of the target, debt issued to bank or other lenders or the owners of the target, or a combination of the foregoing.

Business Combination Agreement

On December 16, 2021, CLAQ entered into an Agreement and Plan of Merger, as amended on January 30 and June 6, 2022 with Merger Sub, and Nauticus. Pursuant to the terms of the Merger Agreement, a business combination between CLAQ and Nauticus will be effected through the merger of Merger Sub with and into Nauticus, with Nauticus surviving the merger as a wholly owned subsidiary of CLAQ. The Board has unanimously (i) approved and declared advisable the Merger Agreement, the Merger and the other transactions contemplated thereby and (ii) resolved to recommend approval of the Merger Agreement and related matters by the stockholders of CLAQ. On January 30, 2022, the Merger Agreement was amended to, among other things, (i) correct certain defined terms in the Merger Agreement; and (ii) include the cash available from the Debt Financing in meeting the "Minimum Cash Condition" defined in the Merger Agreement. On June 6, 2022, the Merger Agreement was further amended to increase the aggregate number of shares of the Combined Company's Common stock to be reserved for issuance pursuant to the Incentive Plan (defined below) from 5% to 10% of the fully diluted outstanding shares of its Common Stock after Closing, which share reserve shall be automatically increased on an annual basis by 3% of the total number of Common Stock outstanding as provided under the Incentive Plan.

Results of Operations

We have neither engaged in any operations nor generated any operating revenues to date. Our only activities for the three months ended March 31, 2022 and March 31, 2021 were organizational activities, those necessary to prepare for the Initial Public Offering, described below, and, after the Initial Public Offering, identifying a target company for a business combination. We do not expect to generate any operating revenues until after the completion of our initial business combination. We generate non-operating income in the form of interest income on cash and cash equivalents held after the Initial Public Offering. We incur expenses as a result of being a public company (for legal, financial reporting, accounting and auditing compliance), as well as for due diligence expenses.

For the three months ended March 31, 2022, we had net income of \$1,951,670, which resulted from by the change in fair value of warrant liabilities of \$2,413,500, a net gain on investments held in Trust Account in the amount of \$17,545, which was partially offset by operating costs of \$458,647, franchise tax expense of \$20,728.

For the three months ended March 31, 2021, we had no revenue or expenses.

For the year ended December 31, 2021, CLAQ had net loss of \$595,442, which resulted from the warrant issuance costs of \$155,037 associated with the IPO, operating and formation costs of \$1,201,383, the change in fair value of the over-allotment option liability of \$225,000, and franchise tax expense of \$97,200, which was partially offset by the change in fair value of warrant liabilities of \$1,077,750, and a net gain on investments held in Trust Account in the amount of \$5,428.

Liquidity and Capital Resources

As of March 31, 2022 and December 31, 2021, the Company had \$296,381 and \$518,905 in cash held outside of the Trust Account, respectively, a working capital deficit of \$220,239 and surplus of \$259,136, respectively.

The Company's liquidity needs prior to the consummation of the Initial Public Offering were satisfied through the proceeds of \$25,000 from the sale of the Founder Shares, and a loan of up to \$250,000 under an unsecured and non-interest bearing promissory note. Subsequent to the consummation of the Initial Public Offering, the Company's liquidity will be satisfied through the net proceeds from the private placement held outside of the Trust Account.

In addition, in order to finance transaction costs in connection with a Business Combination, our Sponsor or an affiliate of the Sponsor, or certain of our officers and directors may, but are not obligated to, loan us funds as may be required ("Working Capital Loans"). As of March 31, 2022 and December 31, 2021, there were no amounts outstanding under any Working Capital Loan.

For the three months ended March 31, 2021, net cash used in operating activities was \$489,524, which was due to a net gain on investments in the Trust Account of \$17,545, the change in the fair value of warrant liabilities of \$2,413,500, and changes in operating assets and liabilities of \$10,149, offset in part by our net income of \$1,951,670.

For the three months ended March 31, 2021, net cash provided by financing activities was \$267,000, which was fully comprised of proceeds from the related party promissory note.

For the three months ended March 31, 2021, there was no cash provided or used in operations.

For the year ended December 31, 2021, net cash used in operating activities was \$1,039,814, which was due to the change in fair value of warrants of \$1,077,750, and net gain on investments in the Trust Account of \$5,428 and our net loss of \$370,442, partially offset by changes in operating assets and liabilities of \$595,442, the change in fair value of the over-allotment option liability of \$225,000, and transaction costs of \$155,037.

For the year ended December 31, 2021, net cash used in investing activities was \$174,225,000, which was due to the amount of net proceeds from the initial public offering and private placement being deposited to the Trust Account.

For the year ended December 31, 2021, net cash provided by financing activities was \$175,758,719, which was comprised of \$169,050,000 in proceeds from the issuance of units in the initial public offering net of underwriter's discount paid, \$7,175,000 in proceeds from the issuance of warrants in a private placement to CLAQ sponsor, \$16,667 in proceeds from the sale of founder shares, and proceeds from issuance of Sponsor Note of \$188,302, offset in part by payment of \$466,281 for offering costs associated with the IPO, \$16,667 for the payment to a related party for the cancellation of founder shares, and repayment of the outstanding balance on the promissory note to CLAQ sponsor of \$188,302.

Going Concern Consideration

As of March 31, 2022, the Company had \$296,381 in cash held outside of the Trust Account and working capital deficit of \$220,239. As a result of the above, in connection with the Company's assessment of going concern considerations in accordance with Financial Accounting Standard Board's ("FASB") Accounting Standards Update ("ASU") 2014-15, "Disclosures of Uncertainties about an Entity's Ability to Continue as a Going Concern," management has determined that the liquidity condition and date for mandatory liquidation and dissolution raise substantial doubt about the Company's ability to continue as a going concern through July 19, 2022, the scheduled liquidation date of the Company if it does not complete a Business Combination prior to such date. These condensed consolidated financial statements do not include any adjustments relating to the recovery of the recorded assets or the classification of the liabilities that might be necessary should the Company be unable to continue as a going concern.

Off-Balance Sheet Arrangements

We did not have any off-balance sheet arrangements as of March 31, 2022 or December 31, 2021.

Contractual Obligations

Promissory Note — Related Party

On March 1, 2021, the Company issued an unsecured promissory note to the Sponsor (the “Promissory Note”), pursuant to which the Company could borrow an aggregate of up to \$250,000 to cover expenses related to the Initial Public Offering. The Promissory Note was non-interest bearing and is payable on the earlier of Promptly after the date on which the Company consummates an Initial Public Offering of its securities or (ii) the completion of the Initial Public Offering. The outstanding balance under the Promissory Note of \$188,302 was repaid on July 23, 2021. The promissory note is no longer available to the Company.

On March 23, 2022, the Company entered into a Promissory Note with the Sponsor (the “Second Promissory Note”) to which the Company could borrow up to an aggregate of \$267,000. The Second Promissory Note is non-interest bearing and payable upon the earlier of (i) completion of the initial Business Combination or (ii) the date on which the Company determines that it is unable to effect a Business Combination. As March 31, 2022, the outstanding balance under the Second Promissory Note was \$267,000.

Underwriter’s Agreement

The Company granted the underwriter a 45-day option to purchase up to 2,250,000 additional Units to cover over-allotments at the Initial Public Offering price, less the underwriting discounts and commissions. On July 28, 2021, the Underwriters exercised the over-allotment option in full and purchased an additional 2,250,000 Units for an aggregate purchase price of \$22,500,000.

In connection with the closing of the Initial Public Offering and subsequent exercise of the over-allotment option, the underwriter was paid a cash underwriting fee of \$0.20 per Unit, or \$3,450,000 in the aggregate.

Related Party Extension Loans

The Company may extend the period of time to consummate a Business Combination up to two times, each by an additional three months (for a total of 18 months to complete a Business Combination). In order to extend the time available for the Company to consummate a Business Combination, without the need for a separate stockholder vote, is for the Company’s initial stockholders or their affiliates or designees, upon five days’ advance notice prior to the application deadline, to deposit into the trust account \$1,500,000 or \$1,725,000 if the underwriters’ over-allotment option is exercised in full (\$0.10 per public share, or an aggregate of \$3,000,000 (or \$3,450,000 if the over-allotment option is exercised in full) if extended for each of the full three months), on or prior to the date of the application deadline. In the event that the stockholders, or affiliates or designees, elect to extend the time to complete the Company’s initial business combination and deposit the applicable amount of money into trust, the initial stockholders will receive a non-interest bearing, unsecured promissory note equal to the amount of any such deposit that will not be repaid in the event that the Company is unable to close a business combination unless there are funds available outside the trust account to do so. Such note would be paid upon consummation of the Company’s initial Business Combination.

Critical Accounting Policies

The preparation of condensed consolidated financial statements and related disclosures in conformity with accounting principles generally accepted in the United States of America requires management to make estimates and assumptions that affect the reported amounts of assets and liabilities, disclosure of contingent assets and liabilities at the date of the condensed consolidated financial statements, and income and expenses during the periods reported. Actual results could materially differ from those estimates. We have identified the following critical accounting policies:

Derivative Warrant Liabilities

The Company accounts for warrants as either equity-classified or liability-classified instruments based on an assessment of the warrant’s specific terms and applicable authoritative guidance in ASC 480, Distinguishing Liabilities from Equity (“ASC 480”), and ASC 815, Derivatives and Hedging (“ASC 815”). The assessment considers whether the warrants are freestanding financial instruments pursuant to ASC 480, meet the definition of a liability pursuant to ASC 480, and whether the warrants meet all of the requirements for equity classification under ASC 815, including whether the warrants are indexed to the Company’s own Common Stock, among other conditions for equity classification. This assessment, which requires the use of professional judgment, is conducted at the time of warrant issuance and as of each subsequent quarterly period end date while the warrants are outstanding.

[Table of Contents](#)

The Company evaluates its financial instruments to determine if such instruments are derivatives or contain features that qualify as embedded derivatives in accordance with ASC Topic 815, Derivatives and Hedging. For derivative financial instruments that are accounted for as liabilities, the derivative instrument is initially recorded at its fair value on the grant date and is then re-valued at each reporting date, with changes in the fair value reported in the consolidated statements of operations. The classification of derivative instruments, including whether such instruments should be recorded as liabilities or as equity, is evaluated at the end of each reporting period. Derivative liabilities are classified in the balance sheet as current or non-current based on whether or not net-cash settlement or conversion of the instrument could be required within 12 months of the balance sheet date.

For issued or modified warrants that meet all of the criteria for equity classification, the warrants are required to be recorded as a component of additional paid-in capital at the time of issuance. For issued or modified warrants that do not meet all the criteria for equity classification, the warrants are required to be recorded at their initial fair value on the date of issuance, and each balance sheet date thereafter. For the initial valuation, the Company utilized a Monte Carlo simulation model for the initial valuation of the Public Warrants, and the publicly-traded value for the subsequent valuation of the Public Warrants. Changes in the estimated fair value of the warrants are recognized as a non-cash gain or loss on the consolidated statements of operations. The fair value of the Private Placement Warrants was estimated using a Black-Scholes Option Pricing Model (see Note 9). The subsequent measurement of the Public Warrants as of March 31, 2021 and December 31, 2021 is classified as Level 1, as such, an observable market quote in an active market under the ticker CLAQW was used.

Common stock subject to possible redemption

The Company accounts for its Common Stock subject to possible redemption in accordance with the guidance in ASC Topic 480, Distinguishing Liabilities from Equity. Common Stock subject to mandatory redemption (if any) is classified as liability instruments and are measured at fair value. Conditionally redeemable Common Stock (including Common Stock that feature redemption rights that are either within the control of the holder or subject to redemption upon occurrence of uncertain events not solely within the Company's control) are classified as temporary equity. At all other times, Common Stock are classified as stockholders' equity. The Company's Common Stock feature certain redemption rights that are considered to be outside of the Company's control and subject to the occurrence of uncertain future events. Accordingly, as of March 31, 2022 and December 31, 2021, 17,250,000 Common Stock subject to possible redemption are presented as temporary equity, outside of the stockholders' deficit section of the Company's balance sheet. Effective with the closing of the Initial Public Offering, the Company recognized the accretion from the initial book value to redemption amount, which resulted in charges against additional paid-in capital (to the extent available) and accumulated deficit.

The Company recognizes changes in redemption value immediately as they occur and adjusts the carrying value of redeemable Common Stock to equal the redemption value at the end of each reporting period. This method would view the end of the reporting period as if it were also the redemption date for the security. Increases or decreases in the carrying amount of redeemable Common Stock are affected by charges against additional paid in capital and accumulated deficit.

Net income Per Share of Common Stock

Net income per share of common stock is computed by dividing net earnings by the weighted average number of shares of common stock outstanding during the period (for all periods during which these shares were subject to forfeiture, the calculation of weighted average shares outstanding excludes an aggregate of 562,500 shares of common stock held by the Sponsor that were subject to forfeiture). The Company has not considered the effect of the Warrants sold in the Initial Public Offering and private placement to purchase an aggregate of 15,800,000 shares in the calculation of diluted income per share, since the exercise of the Warrants are contingent upon the occurrence of future events and the inclusion of such Warrants would be anti-dilutive.

INFORMATION ABOUT NAUTICUS ROBOTICS, INC.

The following discussion should be read in conjunction with the information about Nauticus contained elsewhere in this proxy statement/prospectus, including the information set forth in Nauticus' consolidated financial statements and the related notes. Some of the information contained in this section or set forth elsewhere in this proxy statement/prospectus, including information with respect to Nauticus' plans and strategy for its business, includes forward-looking statements that involve risks and uncertainties. You should read the sections titled "Risk Factors" and "Special Note Regarding Forward-Looking Statements" for a discussion of important factors that could cause actual results to differ materially from the results described in or implied by the forward-looking statements contained in the following discussion. Unless the context otherwise requires, all references in this subsection to the "Company," "we," "us" or "our" refer to the business of Nauticus Robotics, Inc., a Texas corporation, and its subsidiaries prior to the consummation of the Business Combination, which will be the business of the post-combination company and its subsidiaries following the consummation of the Business Combination.

Overview

Nauticus Robotics provides 21st century ocean robotic solutions to combat the global impacts on the world's marine environment. The interconnected, purpose-built product ecosystem of both surface and subsea robots is powered by Nauticus' autonomous software platform that affords our robots real machine intelligence, not just automation. This approach will transform the industry to an economically efficient and environmentally sustainable model. Nauticus Robotics, Inc. was initially incorporated as Houston Mechatronics, Inc. on March 27, 2014, in the State of Texas. Nauticus' principal corporate offices are located in Webster, Texas. The Company is developing an ecosystem of ocean robots that are controlled through an AI-driven cloud software platform which enables a sliding scale spectrum of autonomous operations — from direct operator control to complete hands-off, robot self-sufficient control. Instead of the conventional tethered connection between the operator and the subsea robot, Nauticus has developed an acoustic communication networking, compression, and protocols that allows the robot to perform its tasks without a direct, cabled connection. This offering permits significant operational flexibility and cost savings over the methods currently deployed in the marketplace.

The full range of Nauticus ocean robot technologies combine to provide unique capabilities heretofore not seen in the commercial ocean market and delivered to the market at substantially reduced cost and reduced environmental footprint. Under the current subsea service paradigm, large vessels are deployed with ROVs/AUVs and supporting equipment to the work area. A large surface presence is required to control the robot through direct teleoperation of the vehicle and through robotic manipulators; including the launch, recovery, and transport of the asset to and from the worksite. Direct contact must be maintained with the ROV to provide the teleoperators with sufficient video feedback and transmit control signals. The direct communication requires a tether that is spooled on the deck and reaches depths in excess of 3,000m. The size of this equipment dictates the size of the surface vessel. A larger surface vessel results in a complex infrastructure that creates additional excessive costs. For example, a larger vessel requires more crew members to manage and operate the vessel while on station at a worksite (including transit to and from the work location). Additionally, from an environmental perspective, the GHG emissions from this style of operation can be as high as 70MT of CO₂ per day.

Unlike the current subsea service paradigm, Nauticus' approach features a system without the need for a high-capacity network (fiber) with a traditional ROV. This allows software and autonomy control most of the actions of the machines through a supervised autonomous acoustic network given that in communication is limited to low bandwidth signaling between our small surface ship (Hydronaut) and Aquanaut. These signals are transmitted through satellite communication or other mobile networks (e.g., 4G/LTE/5G) to a shore-based control center where operators "supervise" the actions of the Aquanaut. However, they are not in real time control as in the current paradigm. With no tether required, the ship only carries the Aquanaut and can, therefore, be much smaller. Smaller ships burn far less fuel and thereby (i) incur significantly less expenses, and (ii) reduce greenhouse gas emissions by a significant margin.

Products and Services

Nauticus' ocean robotic ecosystem is headlined by the Company's flagship product, Aquanaut, a vehicle that begins its mission in a hydrodynamically efficient configuration which enables efficient transit to the worksite (i.e. operating as an autonomous underwater vehicle, or AUV). During transit (operating in survey mode), Aquanaut's sensor suite provides capability to observe and inspect subsea assets or other subsea features. Once it arrives at the worksite, Aquanaut transforms its hull configuration to expose two work-class capable, electric manipulators that can

perform dexterous tasks with (supervised), or without (autonomous), direct human involvement. In this intervention mode, the vehicle has capabilities similar to a conventional Remotely Operated Vehicles (ROV). The ability to operate in both AUV and ROV modes is a quality unique to Nauticus' subsea robot and is protected under a US Patent. To take advantage of these special configuration qualities, Nauticus has developed underwater acoustic communication technology, called *Wavelink*, Nauticus' over-the-horizon remote connectivity solution, that removes the need for long umbilicals to connect the robot with topside vessels. Eliminating these umbilicals and communicating with the robot through acoustic or other latent, laser, or RF methods reduces much of the system infrastructure that is currently required for ROV servicing operations and is at the heart of Nauticus' value proposition.

The Argonaut, a derivative product of the Aquanaut, is aligned at non-industrial, government applications. This vehicle embodies many of the Aquanaut's core technologies but varies in form and function necessary to perform specialized missions.

The component technologies that comprise the Aquanaut are also marketable to the existing worldwide ROV fleet. Aquanaut's perception and control software technologies, combined with its sensor platform and electric manipulators, can be retrofitted on existing ROV platforms to improve their ability to perform subsea maintenance activities.

Nauticus' robotic systems will be delivered to commercial and government customers primarily through a Robotics as a Service ("RaaS") subscription business model (a business model planned for future commercial services but not yet implemented), but also as direct product sales, where required — such as to the defense industries.

Nauticus' mission is to disrupt the current ocean service paradigm through the introduction and integration of advanced robotic technologies. These key technologies are autonomous platforms, acoustic communications networks, electric manipulators, AI-based perception and control software, and high-definition workspace sensors. Implementation of these technologies enables substantially improved operations at significantly reduced costs over conventional methods.

Nauticus' portfolio of robotics systems include:

- ***Aquanaut.*** The Aquanaut is designed to be launched from shore or off the back of an autonomous surface vessel to operate as a free-swimming subsea vehicle that is controlled through an acoustic communication system and capable of performing a wide range of inspection and manipulation tasks. The defining capability of Aquanaut is to operate in two separate modes — Inspection and Intervention. The Inspection mode involves the use of sensors during vehicle transit and the Intervention mode uses work class manipulators (Nauticus' Olympic Arms) to perform work in the subsea environment.

The Aquanaut will be offered through RaaS (a business model planned for future commercial services but not yet implemented) and through direct sales to strategic clients. Nauticus has produced two units, one developmental and one is under contract in service with a Department of Defense customer. Three units are in production and are expected to be completed by the end of the third quarter of 2022. The current production timeline for a single Aquanaut is six months, but Nauticus expects that timeline to decrease to three months in coming years, with production efficiency gains and economies of scale. Nauticus expects that it will be able to sell, lease, or add to its commercial service fleet each Aquanaut within a maximum of 90 days of completed production.

- ***Argonaut.*** A derivative of the Aquanaut vehicle is the Argonaut which has enhanced capabilities for transit and autonomous operations. This vehicle has been orchestrated to provide Nauticus' government-facing customers with the capabilities to perform their specialized mission scenarios. The Argonaut is completing final assembly in our facility. Upon completion, expected in the second quarter of 2022, the first Argonaut vehicle will undergo commissioning in the Gulf of Mexico leading to its acceptance by the customer, a Large Confidential Government Contractor, for further use in US government applications. Specifically, this vehicle will be used by a Large Confidential Government Contractor, in conjunction with Nauticus, to perform under a current contract. This product and other variants are already available for direct sales to U.S. Department of Defense entities, contractors, and is planned for future commercial services through a RaaS contract for ongoing services.

Since there is very little difference between Argonaut and Aquanaut except for the outer mold line ("OML"), and minor navigational and other sensors, the current production timeline for a single Argonaut is also six months. But Nauticus expects that timeline to similarly decrease to three months in coming years. Nauticus expects that it will be able to sell or lease an Argonaut within 90 days of completed production.

- **Olympic Arm.** An all-electric, work-class manipulator built to serve ROV and hovering and resident AUV markets, providing an electric advantage that allows for more perception-driven decision making for semi-autonomous tasking. The current existing hydraulic solutions are undesirable for both operating costs and environmental concerns. Fully electric systems that make use of advanced sensing and control techniques will increase reliability and reduce time-on-task (vessel days saved). Further the all-electric architecture helps prevent hydraulic oil spills for the current offering for more environmentally sensitive areas. (e.g., North Sea, Canada, etc.).

The Olympic Arm is currently offered as both a standalone product and as a component to both the Aquanaut and in future models of the Argonaut. As such, the Olympic Arm is offered both through direct sales and is planned for future commercial services through RaaS. As a standalone product, Nauticus is delivering the first unit to the first customer, IKM Subsea, in the second quarter of 2022, followed by a second unit to an additional customer in by the end of the second quarter of 2022. The current production timeline for a single Olympic Arm is two months, but Nauticus expects that timeline to decrease to one month in coming years, with production efficiency gains. Nauticus expects that it will be able to sell or lease an Olympic Arm, or incorporate it into an existing product order, within 90 days of completed production.

- **ToolKITT.** This software suite is a multi-layered, multi-tool, software platform that can operate the Aquanaut, Argonaut, Olympic Arm, or other 3rd party ocean robotic vehicles through all mission phases. Its capabilities include navigational guidance, vehicle, and manipulator control as well as perception and planning and execution of tasks. ToolKITT is currently generating revenue through a Defense Innovation Unit contract. Under this contract, the ToolKITT operates and controls a 3rd party ROV called a VideoRay Defender (a “Defender ROV”) to perform a set of tasks in support of subsea defense operations. Upon the successful completion of this contract, Nauticus will have the opportunity to license ToolKITT to the U.S. Department of Defense for use on their existing fleet of Defender ROVs.

- **Hydronaut.** A small, optionally crewed autonomous surface vessel that will support the real-time operations of Aquanaut in long range and deep water commercial applications. Hydronaut will ferry Aquanaut to and from the worksite and support battery recharging and the over-the-horizons communications link to shore.

The first Hydronaut is currently fulfilling charter days for a Large Confidential Government Contractor, related to a Department of Defense customer. The lease agreement for Hydronaut 1 was based on a usage rate of \$6,000 per day, with no fixed number of operational days, beginning on January 31, 2022. Through the four months ended April 30, 2022, the vessel had only been utilized three (3) days for a total revenue of \$18,000. Hydronaut will support the RaaS model, when implemented, for Aquanaut. Nauticus will also independently offer Hydronaut through RaaS, when available, and currently offers Hydronaut through direct sales. Nauticus currently has one Hydronaut in service. It also has two more Hydronauts in production with Diverse Marine, in the UK, which are expected to be completed by the end of the first quarter of 2023. Nauticus expects that it will be able to sell, lease, or add to its commercial service fleet, a Hydronaut within 90 days of completed production.

Nauticus has an experienced team with deep operational expertise in bringing emerging technologies to market. Nauticus’ engineering and design efforts are led by a highly experienced robotics team with over 200 years of cumulative robotics experience. Nauticus’ core engineering team has been working together for over 10-15 years and has designed and deployed advanced robotics systems for both public and private market applications.

Nauticus’ engineering process is a blend of Agile principles and a traditional phase-gate development workflows. The nature of robotics is highly intra- and multidisciplinary, containing both hardware and software components and requires a blend of both design methodologies. On the hardware side, Nauticus has created two design workflows (Standard Design and Simplified Design) that allow for quick-turn development as well as rigorous and detailed engineering work. Nauticus has also implemented a modified Agile Scrum workflow that allows for continual delivery of value, ability to change priorities, and resolve problems quickly.

Nauticus’ principal executive offices are located at 17146 Feathercraft Lane, Suite 450, Webster, TX 77598. Our telephone number in the USA is (281) 942-9069. Additional company and product information is available at www.nauticusrobotics.com.

Current Operations and Transitions

Nauticus Robotics is transforming from a business where revenue was primarily generated through engineering service contracts, with both government and commercial customers, to a company that performs subsea robotic services through various technology-based products. Aquanaut is currently under a services contract with the government, through a Large Confidential Government Contractor, as a robotic platform for a government customer. In addition, Hydronaut 1 is also chartered under a Large Confidential Government Contractor, for program operations as a surface support vessel during Aquanaut subsea testing. The Olympic Arm product is being commissioned for its first delivery to IKM Subsea for acceptance testing under a purchase order agreement. The ToolKITT software is currently undergoing testing and trials with the Defense Innovation Unit on the VideoRay Defender ROV platform. The successful outcome of this testing will lead to the deployment of ToolKITT on the existing Defender ROV fleet (possibly resulting in 99 licenses) used by the U.S. Navy. These initial orders substantiate our belief that these products are emerging into a revenue generating status, although it is recognized by Nauticus that further commercial maturity will be required as these products are introduced and scaled into the market. The status of these products is “early stage” since the development of commercial success is concomitant with further improvements to these products based on additional market feedback.

Nauticus Robotics has successfully performed under previous projects and continues to advance subsea vehicles, manipulation, and autonomy technology space. Nauticus leverages its relationship with advanced technology areas of the U.S. Department of Defense to improve the capabilities of its products and advance their state-of-the-art.

Nauticus currently uses its surface vessel, the Hydronaut, for transport and communications node for the Aquanaut as it performs subsea tasks. This paradigm substantially reduces the size of the surface expression of the support infrastructure and thereby significantly reduces burning of hydrocarbon fuels during the work campaigns. Using these substantially smaller support vessels, with far fewer crew members (and eventually zero crew members), dramatically reduces costs. The autonomous/semi-autonomous operating modes of vehicles like the Aquanaut improve robot performance and reduce the time for task completion. Each of these key operational characteristics improves the efficiency of the service delivery and makes for a more environmentally sustainable operation.

Industry Background

Evolution of Aquatic Robotics

The modern ocean robotic vehicles known as unmanned underwater vehicles (UUVs) can be traced to work performed by the US Navy in the 1960's. As this technology developed through the 1970's and 80's, the oil and gas industry began to utilize this technology to support exploration projects in water depths that exceeded the capability of human divers. Since these beginnings, remotely operated vehicles (ROVs) and autonomous underwater vehicles (AUVs) have expanded their reach into many fields beyond the ocean energy marketplace. These robotic vehicles have played a key role in exploration and discovery as well as ocean rescue missions. Today, these vehicles are routinely used to perform a wide variety of tasks in support of many fields of use including offshore wind energy and aquaculture.

UUVs generally have two missions: data gathering or manipulation. They are operated in two distinct classifications — remotely operated or autonomous. The current vehicle designs are optimized and limited to performing one mission or the other. The long-range observation and data gathering missions are often oceanographic data, communication cable inspections, or subsea topographical surveys. These vehicles are usually AUVs and are non-hovering, tetherless ‘submarine shaped’ hulls optimized for long range cruising. Not only do these platforms neglect any manipulation, it also makes them less than ideally suited for tasks requiring high maneuverability. There are some hovering AUVs and even some that offer limited manipulation. However, these hydraulic arms are very rudimentary add-on features incapable of complex coordination or more advanced concepts like goal directed, impedance-force control.

On the other hand, most manipulation missions are performed by ROV designs. These *tethered* robots are specifically aimed at subsea manipulation which are attached to topside support vessels for power and communication. As such, they take advantage of high data rates and the power rich environment afforded by the tether. Although operator fatigue is a notorious problem, most ROV operators are paid ‘by the hour’ and that has unfortunately held down advancing the state of the art in operational efficiency, control, or manipulation sophistication. And it is these exact technology advancements that are required in a communication poor, power limited environment.

There is an emerging need for the hybrid operation: a highly maneuverable platform that can perform manipulation work and also travel efficiently for tens of kilometers. This might include deployment from shore or from some other vehicle and then traveling large distances to then perform manipulation or observation work or both.

Market Opportunity

Although AUV and ROV technology has progressed over the years, the fundamental solution architecture has not changed from its beginning. Servicing missions at depth requires a large surface ship and for intervention tasks, tether spooling systems to be mounted and controlled from the vessel. Beyond the obvious mobilization/demobilization and operating costs of the ship, the tether system introduces its own set of operational challenges and constraints to account for entanglement and sea current-induced disturbances. The size and complexity of the tether system contributes to the size requirements of the vessel. The current paradigm typically includes onboard crew to operate the ROV, further increasing the vessel requirements. The current architecture drives the high cost of this service through the large size of the surface vessel combined with the encumbrance of the connecting cable between the surface vessel and the ROV.

The Nauticus Robotics solution addresses the primary factors that drive the cost of the current servicing paradigm. Eliminating the need for the several thousand meters of cable and therefore the onsite vessel and people using acoustic communications substantially reduces the cost of operations. In addition to removing the cost and maintenance of the cable, the surface vessel does not need to accommodate the size and complexity of this system, reducing its size and associated cost. Reducing the size of the surface vessel yields cost savings through reduced crew and vessel operating cost. Importantly, reducing the size of the surface vessel also substantially reduces the carbon expression during servicing operations.

Removing the cable, which provides high bandwidth communications between the surface and the ROV, while still performing dexterous manipulation tasks has been a central technical achievement of Nauticus Robotics. Increasing the autonomy of the ROV through artificial intelligence enables the full set of capabilities required by the market but achieved through low bandwidth data links. In this new control paradigm, high-bandwidth teleoperation gives way to low-bandwidth supervised autonomy. Taking the responsibility for robotic interventions from a real-time operator and placing it with the robot itself also improves performance of the system by reducing task completion times. This benefit results when the robot, not the operator, compensates for local disturbances while completing tasks in the workspace.

Another key benefit provided by Nauticus Robotics' Aquanaut is its unique ability to transform its hull to optimize performance during different phases of the mission. The AUV-style, hydrodynamically efficient hull configuration enables the robot to traverse long distances when performing subsea pipe or cable inspections. After this transit, the vehicle can transform its shape to expose workclass-capable manipulators to interact with its environment. This ability to transit long distances and then perform manipulation tasks is enabled by both the vehicle design as well as the freedom from a cabled surface connection. This unique capability of the Aquanaut brings new capacity to subsea robotic interventions and further disrupts the status quo.

Nauticus Robotics believes that these new technical advances will redefine how ocean intervention services are performed. However, it is possible that these beliefs will prove incorrect. For additional discussion of risks relating to operational and financial projections, please see *"Risk Factors — Nauticus' operating and financial projections rely on management assumptions and analyses. If these assumptions or analyses prove to be incorrect, Nauticus' actual operating results may be materially different from its forecasted results."*

The new and unique capabilities of the Aquanaut represent a significant market opportunity for Nauticus Robotics to disrupt the ocean services marketplace, especially given the lack of comparable systems.

The market for this technology is vast and covers several independent market segments including offshore renewables, oil & gas, telecommunications, aquaculture, mining, defense, ports, and shipping just to name a few. The worldwide energy (O&G & Wind) IMR services market is projected to grow based on aging assets with O&G, and asset growth with Offshore Windfarms.¹ Over the next 4 years, there will be tremendous growth of wind farm infrastructure installed into the global offshore market.² Currently, 25GW of offshore renewables are installed off the coast of Europe with expectations to double by 2030. The Biden Administration announced the installation of 30GW of offshore

1 Source: <https://www.westwoodenergy.com/reports/world-rov-operations-market-forecast-2019-2023>.

2 Source: <https://gwec.net/global-offshore-wind-report-2021/>.

renewables by 2030 to be installed off American shores. In total, that would include around 15,000 more wind turbines to be installed in just the United States and Europe. Today these markets are served by service companies offering Vessel based services with the cost of these services being split substantially on the cost to operate the vessel over the ROV.

Overall, the Defense market is expected to perform strongly in the next 5 years as geopolitical tensions continue to indicate that peer competitor and near-peer competitor engagements are likely in the ocean domain. The U.S. Department of Defense periodically issues Offset Strategy reports that summarize strategic planning and analysis as guidance for future technology investments. As highlighted in the 3rd Offset Strategy, unmanned systems especially in the maritime domain will be front and center and see heavy investment. Highlighted by the inherent stealth of the undersea domain presents, this will see sharp increase in development spending and acquisitions. In general, the geo-political tension drives defense spending for reconnaissance and covert littoral battlefield, and deepwater assets such as Aquanaut and our customers have affirmed this belief. COVID-19 has had a minimal effect on defense spending on our products. We have seen some increase in discretionary spending even while COVID-19 has caused a decrease in government spending in other areas. We do not expect a reduction in spending from supporting agencies.

The use of technology like Aquanaut is a significant topic in port security and management but is difficult to properly assess through industry reports alone. Due to this, our findings through target customer interactions is the size of the port and security market and expected adoption in the next 3 – 5 years will be substantial. As a point of reference, there are over 800 major ports worldwide and Aquanaut can address the work required to assess port seabed conditions, vessel hull anomalies, sensor placements and retrievals, change detection monitoring and unauthorized vessel detection. We plan to have multiple service offerings for the Port and Harbor Security Market through vehicle sales and leases to the customer, including all equipment necessary to conduct Aquanaut missions. This will lead to Autonomy as a Service, using the ToolKIT and a behavior development license agreements for our customer base. Aquanaut is an excellent multi-tool, but many of the ‘tools’ required for the vehicle are software based. Due to the specific nature of security requests, we believe that custom development will be a requirement. We plan to provide over the air updates from our Houston based engineering team will ensure that vehicles are equipped and qualified with the latest behaviors in our autonomy framework. We believe we will have a residual revenue opportunity through a long term license for the autonomy updates.

Aquaculture is expected to increase significantly. With the world’s population on course to reach 9.7 billion by 2050, the global demand for protein is expected to grow by 40%.³ One way to meet our protein needs is to sustainably maintain both wild fish reserves and farmed fish. Furthermore, the rising trend of smart fishing and the increase in seafood trade is also propelling the demand for aquaculture products. Major factors driving the growth of the market include rising demand for protein rich aqua food across the world, rapid adoption of advanced technologies — IoT, artificial intelligence (AI), feeding robots, and underwater remotely operated vehicles (ROVs) on aquaculture farms; increasing investment and rising R&D expenditure in aquaculture technology worldwide; and the growing popularity of land-based recirculating aquaculture systems.

The most addressable portion of this market today is associated with how Salmon is farmed in both Norway and Chile, South America. Regular net cleaning is important to maintaining the health of the fish and the current man in the loop semi-automated cleaners damage the netting over time and nets break. When the nets break the fish are lost, but the farmers are also fined for allowing farm fish to escape into the wild population of fish. Aquanaut-type and Aquanaut technologies could reside within the farm, clean the net more regularly, in a less aggressive manner that reduces net wear. This robot could also use its machine vision technology to measure and classify the net wear characteristics over time which would trigger preventative maintenance in order to avoid nets break, and by doing so avoid the fine.

The Nauticus Robotics Solution

We are developing a portfolio of ocean robotic vehicles and manipulators controlled by our multi-layered software suite. This software provides sensed perception of the environment combined with guidance, navigation, and control of the vehicle. Additionally, the software suite provides cutting-edge intelligence to control the dual arm manipulators to perform dexterous tasks. Complex task execution without a high-bandwidth tether to the robot necessitates a command-and-control architecture that permits local command authority as well as a level of self-sufficiency to execute high-level, human-directed tasks. Many studies have demonstrated that naive implementation of autonomy can

3 Source: Henchion M, Hayes M, Mullen AM, Fenelon M, Tiwari B. Future Protein Supply and Demand: Strategies and Factors Influencing a Sustainable Equilibrium. *Foods*. 2017;6(7):53. Published 2017 Jul 20. doi:10.3390/foods6070053.

result in opaque systems unless a focus of the system architecture is the interdependence between human and robotic system. Besides basing our success metrics on operator mental burden, advances in three key areas will differentiate this architecture. Those areas are automatic task planning, probabilistic-based perception, and novel data compression.

Our technological innovations also include:

- A subsea vehicle that can transform its hull shape from a hydrodynamic transit vehicle to a working ROV mode that exposes two workclass manipulators
- A multi-layered software subsystem that handles vehicle control, perception, and manipulation that are supported through machine learning paradigms
- An acoustic-based mesh network communication system that provides multi-point communication capabilities between multiple subsea vehicles and the sea surface

We believe the primary drivers towards the adoption of Nauticus Robotics' products include:

- Substantial reduction in the cost to deliver subsea inspection, maintenance, and repair services will yield disruptive cost savings to customers
- Reduced carbon footprint provided by the reduction in size of the surface vessels required to perform work
- Reduced number of crew exposed to offshore work hazards
- Additional cost savings through fewer vessel days due to improved operational efficiencies
- Reduction of hydraulic fluid leaks

We believe the benefits of our robotic systems will have clear implications across many industries including offshore wind, port security, aquaculture, traditional energy, subsea mining, and telecommunications.

Competitive Strengths

Differentiated and Proprietary Technology

Several key technical advances underpin the Nauticus Robotics ocean technology and service offering. Namely, an acoustic communication protocol and capability to control ocean robots and perform complex tasks without the need for a high-bandwidth, cabled connection between the operator and robot. The freedom from constraining tethers enables a freedom of movement that is unprecedented in previous ocean robotic archetypes. Taking advantage of a tetherless control paradigm motivates a vehicle that can transit long distances and then interact with objects in the workspace. This new type of subsea robotic archetype, which we call an Autonomous Underwater Robotic Vehicle (AURV) is capable of a changeable hull configuration that is efficient for transit and then transforms to expose manipulators used to perform tasks at a designated worksite. This new robotic vehicle archetype is protected for Nauticus Robotics by US patent.

Early Mover Across Key Markets

Nauticus Robotics has market tested its product portfolio through demonstrations to potential customers and discussions with industry leaders in the target markets. Prospective customer response has been positive and this has been reflected in the numerous paid studies under contract with major energy customers to detail the Nauticus solution to their use cases. Nauticus Robotics has organized an Advisory Panel with high-level representatives from commercial and defense markets that also serves as a focus group to test and guide Nauticus product development activities. Each of these members have offered their positive feedback regarding product features and capabilities.

Visionary and Experienced Management

We have an experienced team with deep operational expertise in bringing emerging technologies to market. Our team is led by Nicolaus A. Radford, our Chief Executive Officer who has over 20 years of experience with robotics and technical leadership. Our engineering and design efforts are led by a highly experienced robotics team with over 200 years of cumulative robotics experience, with our core engineering team trained in high-tech robotics at NASA and working together for over 15 years.

[Table of Contents](#)

The nominees for the board of directors of the post-combination company have extensive experience across a wide array of disciplines including the industries that Nauticus intends to serve. This technical and commercial expertise will guide the production and delivery of complex hardware and software solutions to the market. For more information about the expected composition of the board of directors following the consummation of the Business Combination, see the section entitled “*Management After the Business Combination.*”

Strategic Collaborators

We collaborate with market leaders in complementary technologies such as energy storage and sensors while nurturing market relationships with key customers. Our collaborations with high profile industry leaders provide valuable feedback that we believe will enhance our early mover advantage. We also expect that these relationships will provide us enhanced credibility and better lead generation and conversion of additional potential customers.

Growth Strategy

The key elements of our growth strategy include:

Accelerate the Development of our Robotic Systems

Nauticus Robotics is committed to the development of a complete ocean eco-system of robotic technologies. Each product is developed from an advanced automation perspective with focus on increased performance, lower cost, and environmentally friendly operations. The Nauticus product portfolio includes a new archetype of subsea vehicle, the AURV we call Aquanaut, that can change its configuration to optimize performance during various transit and manipulation phases of the mission. Our expertise in dexterous manipulation supports the deployment of electric, subsea manipulators that will be used by Nauticus for its own vehicles, but that also address a market need to retrofit existing ROV's with manipulators that have both workclass strength and reach envelopes. ToolKITT integrates total robot and vehicle functions that simplify operational control through ‘mouse clicks’, not joysticks. This superior approach to operational control of robots reduces both task times and mission cost. The Nauticus acoustic communication technology serves as a many-to-many data connection between multiple mobile assets in the marine environment. This technology enables multiple robotic actors to participate in complex servicing activities with over-the-horizon control by remote operators. These products combine to minimize mission execution cost, enhance safety, and enable the application of state-of-the-art robotic technologies to the needs of the ocean customer.

Continued Investment in Innovation

We will continue to invest significant resources in developing proprietary technologies across hardware, firmware, software, and controls to commercialize our robotic systems. We expect our research and development activities to focus on various sizes of vehicles and manipulators to meet different market needs. Improving network data communication to include both acoustic and optical modalities that optimize bandwidth over the near and far range is also a part of the development roadmap.

Our Product Platforms

We expect to offer a range of robotic systems that draw on our intellectual property, years of expertise, and innovative core technologies.

Aquanaut

The Aquanaut represents a new type of subsea vehicle that takes advantage of new subsystem technologies to bring best-in-class performance to the ocean realm.

We believe the following to be the key capabilities of the Aquanaut:

- Transformable hull design that enables efficient operations in transit (AUV mode) and at the worksite (ROV mode)
- All-electric design for both propulsion and manipulation
- Capable of operating under supervised autonomy and fully autonomous vehicle control modes

[Table of Contents](#)

- Multi-modal sensor suite capable of creating a high resolution 3-D map of the near-space environment to support manipulation
- Onboard navigation that enables extended transit to a worksite

Hydronaut

An 18m long, optionally crewed vessel that will support the real-time operations of Aquanaut in commercial applications. Hydronaut will ferry Aquanaut to and from the worksite and support battery recharging and the over-the-horizons communications link to shore.

ToolKITT

ToolKITT is a cloud software platform consisting of interrelated products for ocean sensing, manipulation, autonomous behaviors, survey, search & recovery, and manual intervention. This functionality encompasses robotic controls, user interfaces, sensor integration, simulation, data analysis, and communication frameworks purposely built to enable work subsea. This software unifies all of Nauticus' products into a single control architecture. This system includes a communications middleware that orchestrates vehicle activities, performs updates, and enables multi-agent interaction and mission planning. However, the software platform can also be used across other robotic platforms in the ocean space and, theoretically, outside of the ocean domain as well.

This product embodies a complete command and control suite of software components that provide the intelligence necessary to transit and perform work with minimal interventions. Although the entire suite is comprised of the following components, each one is capable of existing independently, being seamlessly integrated into existing customer platforms and systems:

- ***Helmsman*** — Safe, efficient, reactive, on-board control system for maritime robotic platforms
- ***Commander*** — Mission planning, autonomy, and direct commanding of maritime robotic platforms
- ***Wayfinder*** — Perception-based mapping and world modelling
- ***Wavelink*** — Disruption-tolerant, secure, communication network for maritime robotic platforms
- ***Loggerhead*** — Data collection and analysis for customer data products and diagnostics

Olympic Arm

The Olympic Arm is an all-electric, work-class manipulator built to serve the remotely operated vehicle (ROV) as well as the hovering and resident AUV markets. These manipulators provide an electric advantage that allows for more perception-driven decision making for semi-autonomous tasking. The existing hydraulic solutions cannot achieve this and therefore will be replaced in the pending recapitalization of the market. In other words, fully electric systems make use of advanced sensing and control techniques that will increase reliability and reduce time-on-task (vessel days saved). Further the all-electric architecture helps prevent hydraulic oil spills for the current offering for more environmentally sensitive areas. (e.g. North Sea, Canada, etc). This arm has similar kinematic characteristics to workclass ROV hydraulic arms currently used in the market and can be retrofitted into existing ROV designs.

- 6-7 actuated degrees of freedom
- All-electric design
- Force sensing and control
- Autonomous tasking and tool change capability

HaloGuard

The HaloGuard system is a restricted access monitoring and control system powered by deep Learning algorithms that are deployed into hazardous operational areas. HaloGuard is currently deployed for redzone management in offshore platforms.

Competition

Current Solutions:

Ocean Services utilizing AUVs/ROVs are based on vessel companies contracting two ways with clients — Long Term Annual Contracts and Spot Market Contracts. ROV Vessels — the price ranges from \$40k/day to \$100k/day depending upon specification of vessel with ROVs at \$8k/day to \$10k/day. These vessel companies either own their own fleet of AUV/ROVs or they subcontract with an AUV/ROV services providers. The mobilization and demobilization costs of the equipment is an additional service fee, the majority of the time. AUVs are utilized within the market differently than ROVs with smaller survey vessels used that do not have crane systems or DP2 position control classification. These types of vessels will cost up to \$60k/day with the AUV related costs being between \$10-20k/day.

Sample of Traditional Energy Market Service Providers:

- Oceaneering*
- Subsea 7*
- Fugro*
- DOF
- C-Innovations
- Helix
- Saipem*

(*build their own ROVs and buy Hugin AUVs from Kongsberg).

Sample of Platform Manufacturers (Product Sales):

- Forum
- TechnipFMC (now moving into services)
- SMD
- SAAB

(Products are sold to service providers with a margin rate ranging from 30-50%.)

Sample of Autonomous Surface Vessel coupled to Subsea Platform Assets:

- Ocean Infinity
- Reach Subsea
- Fugro

Drawbacks to the current business model:

Contracting is based on discrete services being rendered, and value gets converted into a day rate. There is an emphasis on how the job is done and not what job is done, and it is billable accordingly. For example, the entire work process is broken down into steps and phases and the service contractor bills for each step. There are mobilization costs, trip costs, stand by costs, actual onsite costs, costs for tooling, demobilization costs, etc.

Customers and Partners

Nauticus Robotics is actively engaged in the development of specialized ocean vehicles for the U.S. Government interests. In this work, we are teaming with a Large Confidential Government Contractor to deliver ocean vehicles that meet the challenging objectives of the US Services. At times, we are a direct performer for the Defense Advanced Research Projects Agency for the development of advanced ocean capabilities.

For go to market in commercial ocean services, Nauticus Robotics has teamed with local service providers in the North Sea to leverage their relationships with customers operating in this active region for ocean energy services. Through our investment relationship with both Transocean, Inc. and Schlumberger, we have in place a global footprint of opportunities to pursue and infrastructure that can be leveraged to expedite service deployments.

Customers

Nauticus Robotics currently has developed two models of subsea robots — Aquanaut and Argonaut. The vehicles both exhibit the ability to traverse long distances, transform its hull to expose dual robotic manipulators, perform robotic tasks, and then return to the launch site or other predetermined location. The Aquanaut is designed to meet commercial requirements related to performing inspection, maintenance, and repair work in subsea oil and offshore wind energy applications. Its capabilities also satisfy the requirements established for port security and maintenance, aquaculture, and telecommunications or subsea mining markets. In this setting, the vehicle performs a variety of tasks, including inspection, maintenance, and repair of customer assets. The Argonaut is designed for a different mission set that is driven by the needs of the U.S. Department of Defense. The Argonaut is distinguished from the Aquanaut in several ways, but most importantly, this vehicle is capable of extended range during transit. Other distinguishing features include a different sensor complement and improved autonomous behaviors. Nauticus has created two separate vehicles for two important markets in order to allow each vehicle to evolve to meet the requirements of their respective market. But more importantly, the Argonaut contains technology that makes it ITAR restricted whereas the Aquanaut does not contain such technology.

The Aquanaut is currently under contract, through Nauticus' subcontract with a Large Confidential Government Contractor, for a government customer. The initial Aquanaut commercial fleet is planned for delivery to the United Kingdom in the fourth quarter of 2022, where it will be tested and qualified in the North Sea. Initial opportunities for commercial work will be through Ramfjord Technologies and/or Stinger Technology. Nauticus Robotics has executed a Memorandum of Understanding (MOU) with both of these companies to pursue opportunities in the North Sea.

Nauticus and Schlumberger recently partnered together during the 1st quarter of 2022 and collaborated on a multi-year competitive opportunity valued at more than \$10,000,000, from a large South American oil and gas operator. The potential award notification is imminent and is expected by the end of the second quarter of 2022. Nauticus is also engaged by a Norwegian Super Major who has awarded a first stage contract that will result in a pilot of the RaaS service in the summer of 2022 in the Gulf of Mexico.

In addition, Transocean, Inc., the world leader in offshore drilling for oil exploration and production, has been an invested partner with Nauticus since 2018. Opportunities to deploy Aquanauts off Transocean drilling rigs has already been extensively discussed between Nauticus and Transocean.

The first Argonaut is in final assembly and integration at the Nauticus facility in Webster, TX. This vehicle is scheduled for customer acceptance in spring 2022, and subsequently prepared for delivery to a Large Confidential Government Contractor. The Argonaut will be outfitted with special sensors and equipment to support its deployment on specialized missions for various U.S. defense and intelligence agencies.

Nauticus also plans to leverage its Collaboration Agreement with a Large Confidential Government Contractor to pursue business opportunities in these markets. The Collaboration Agreement was entered into on December 4, 2020, for a term of two years. The Collaboration Agreement covers the design, integration, and assembly of a modified vehicle and integrated systems.

The Collaboration Agreement serves to give Nauticus Robotics access to classified markets within the government and defense industries. This access to the classified markets is greatly simplified by the Collaboration Agreement as at present Nauticus does not easily possess access to this particular customer base, which includes U.S. government intelligence agencies. The Collaboration Agreement subsequently will foster and provide Nauticus with greater access to contracts with U.S. government agencies and entities (among other opportunities within the classified defense/governmental arena). The Collaboration Agreement establishes a mutually beneficial arrangement that provides an administrative buffer between Nauticus Robotics and the eventual end customer requiring special security oversight and data controls. This agreement is also competition sensitive. A copy of the Collaboration Agreement is included as Exhibit 10.31 hereto.

[Table of Contents](#)

In addition to the subsea vehicles, Nauticus has signed a Purchase Agreement with IKM Group in Norway for an Olympic Arm — Nauticus’ all -electric, work-class, subsea manipulators. This robotic arm is set to be delivered to the IKM Group by the end of the second quarter of 2022 and undergo work in Norway. These manipulators are targeted for the existing ROV fleet of commercial subsea service providers, such as Oceaneering International, SMD, and Fugro.

Nauticus has also developed a full featured software stack, called ToolKITT, that provides autonomous and semi-autonomous control modes covering all aspects of subsea vehicle missions. This software, although indigenous to Nauticus’ own subsea vehicles, can also be deployed in existing ROV’s to enhance and expand their operational capabilities. This software is currently showcased in the Defense Innovative Unit contract as the intelligent machine driving the VideoRay Defender ROV. At the conclusion of this contract, Nauticus will have the opportunity to deploy this software system under license to the U.S. Navy for use on their existing Defender ROVs.

Material Contracts

Nauticus has derived significant revenue from its U.S. Department of Defense related contracts and customers. Recently, due to security clearance implications, these contracts have primarily functioned as a subcontractor to a traditional U.S. government contracting company, whereby that Large Confidential Government Contractor administers the contract and handles any sensitive and classified access to the information and mission sets. Most recently, a particular phase of the U.S. Department of Defense program that we have been involved with for a couple of years was subcontracted to a Large Confidential Government Contractor, which began in June 2021 and will run through December 2022. Subsequent phases of this contract will run to mid-2024. This contract is to develop highly advanced autonomous subsea vehicles that provide autonomous navigation and manipulation capabilities for use on Nauticus’ Aquanaut and Argonaut vehicles. In this contracted program, the U.S. Department of Defense has also signalled its intent to purchase an additional Argonaut vehicle from Nauticus for \$10.69mm. Additionally, the contract leases the Aquanaut subsea vehicle for data collection, manipulation autonomy, and operational use in support of this program.

Nauticus is also a prime contractor for the Defense Innovation Unit and has a contract to integrate the Nauticus ToolKITT software platform with the VideoRay Defender ROV platform. This software will substantially improve the VideoRay Defender’s autonomy and capability to perform specialized missions for the U.S. Navy.

These contracts mentioned herein are included as Exhibits 10.24 and 10.25 to this prospectus.

In addition to these material contracts, Nauticus is also the counterparty of various manufacturing and supply agreements that are included herein as Exhibits 10.20, 10.21, 10.22, 10.23, and 10.24. A summary of their key terms are included in the chart below.

Exhibit	Agreement	Key Terms
10.20	Battery Supplier Agreement, dated as of January 18, 2021	Purpose: Li-ion subsea battery supply Term: Approximately 1 year from quote to delivery Termination: Contract delivery complete
10.21	Fabrication Agreement, dated as of January 17, 2022	Purpose: Outsourced Manufacture of Aquanauts Term: 9 months (Time and Materials) Termination: 7 days notice
10.22	Construction Agreement, dated February 14, 2022	Purpose: Fabrication of two Hydronaut vessels Term: Approximately 1 year Termination: By written notice, subject to breach of fundamental terms, insolvency, and other requirements therein.
10.23	Commercial Proposal, dated December 6, 2021	Purpose: Purchase of Drix vehicle for use with Aquanaut Term: Approximately 7 months Termination: Upon breach (without remedy within 30 calendar days), termination of order, and other requirements therein.
10.24	Defense Innovation Unit Agreement, dated August 10, 2021	Purpose: Purchase order of supplies/services Term: Approximately 24 months Termination: By government with written notice and other requirements therein.

Research and Development

The Nauticus Robotics engineering team includes multi-disciplinary skills in mechanical engineering, electrical engineering, artificial intelligence, systems engineering, and computer science. The technical team is composed of research engineers from NASA's Johnson Space Center robotics lab and balanced by roboticists from the subsea energy and commercial robotics sectors. Key technical elements of solutions for space robotics are migrated by this engineering team to the ocean realm and applied to the Aquanaut platform. The focus of this team is the development of ocean vehicles that can perform dexterous manipulation with limited and latent communication between the robot and operator.

Our Agile-based research and development processes emphasize rapid prototyping, testing, and design iterations to meet market-driven requirements.

Sales and Marketing

Our commercial sales and marketing efforts will be direct to customers as well as through teaming agreements with complementary service providers. The North Sea, Gulf of Mexico, Southeast Asia, and offshore Brazil are all areas where near term business is anticipated through commitments from customers and service providers. The sales of Argonaut will take advantage of our existing relationships within the defense industry, both direct to government officials as well as through our ability to subcontract through other government contractor organizations.

We intend to operate on a RaaS business model (a business model planned for future commercial services but not yet implemented) for commercial services supported by the Aquanaut platform. This approach emphasizes the recurring revenue model for extended service contracts and transfers customer expenditures from capital to operating expenses.

Manufacturing and Suppliers

As part of the original development of engineering prototypes, Nauticus Robotics has established supplier relationships with key COTS and custom part manufacturers. Consideration is given within our international supply chain for redundancy, where possible. In cases of limited supplier options, Nauticus Robotics initiates procurement early in the manufacturing schedule to mitigate risk of supply interruption.

Currently, Nauticus manages a supply chain with many suppliers that specialize in parts aimed toward subsea vehicles. A shared and key component of Aquanaut and Argonaut subsea vehicles is the energy storage system — a Li-ion battery. There are a variety of suppliers available to provide this battery subsystem. One battery, in particular, that Nauticus uses is from SubCTech, a German company. The batteries are a long lead time item and are ordered well in advance of the time they are required to be integrated into the vehicle. A copy of the most recent SubCTech battery contract is included as Exhibit 10.20. However, there are suitable replacement battery systems, and Nauticus is not dependent on SubCTech necessarily (e.g. Kracken). In the most extreme event that battery suppliers are unable to produce battery packs for Nauticus, Nauticus might and could resort to pulling that subsystem vertical and producing batteries for the subsea vehicles in house. Nauticus has tremendous battery design, manufacturing, and assembly expertise and former NASA energy systems division experts are on staff.

For parts and fabricated components, Nauticus is using an outsourced manufacturing strategy to fabricate Aquanauts (subsea vehicle) and Hydronauts (optionally crewed surface vessel). This strategy reduces in-house manufacturing and allows Nauticus to perform the final integration and functional acceptance test of the Aquanaut prior to shipping. Nauticus has three (3) Aquanauts that are under a fabrication contract with International Submarine Engineering (ISE) a British Columbia, Canadian company. Two (2) Hydronauts are under contract with Diverse Marine in the United Kingdom. The contracts for the ISE Aquanaut fabrication and the Diverse Marine Hydronaut vessel builds are included as Exhibits 10.21 and 10.22.

Nauticus also has a purchase contract with iXBlue (France) to purchase a Drix unmanned surface vessel. This vessel also pairs with the subsea Aquanaut as a communications node in place of the Hydronaut. A copy of the contract is included here as Exhibit 10.23.

As we progress toward production of our ocean vehicles, trade studies will be conducted to identify subassembly outsourcing options that will reduce the number of parts required in-house for final assembly at our facility. We recognize that the outsourcing trades may have advantages in limiting required lease space, tooling, and manpower requirements, but these benefits may be offset by quality control or other issues leading to full in-house assembly of the vehicles. Nauticus Robotics is committed to exploring the options that will lead to the most capital efficient manufacturing process and support our sales driven build schedule.

Government Regulation

In addition to our compliance regarding federal regulations affecting businesses of this type, Nauticus Robotics also maintains compliance with the International Traffic in Arms Regulations (ITAR) and Export Administration Regulations (EAR) governing the sale of our technology products. In addition to these commercial regulations, compliance with the U.S. Department of Defense requirements for safeguarding data and other sensitive information is a main focus of the organization.

Intellectual Property

The ability to obtain and maintain intellectual property protection through patent and trademark filings is important to our business. Nauticus Robotics utilizes a combination of the protections afforded to the owners of patents, copyrights, trade secrets, and trademarks to secure its intellectual property. In addition, Nauticus Robotics requires employment agreements which stipulate IP protections for the company. For external relationships, non-disclosure agreements and other contractual restrictions are used to establish and protect our intellectual property.

Nauticus Robotics will file for patent protection if the invention is believed to be patentable and the resulting patent will be beneficial in protecting the invention in the marketplaces. Consideration is also given, particularly with respect to software, as to the benefits of seeking a patent against the associated market risks of providing public exposure of the invention. In many cases with our software, Nauticus Robotics holds this code and algorithms as trade secrets.

Nauticus Robotics has patented its reconfigurable hull design for subsea vehicles. This approach protects the company's vehicle configuration that enables it to transit long distances and then transform into a working robot once at the worksite. This capability is key to exploiting the vehicle architecture and its tetherless operational modes. Similarly, Nauticus Robotics has applied for patent protection for its all-electric, workclass robotic manipulators. These manipulators are the first in their market class and utilize specialized actuation systems to achieve the strength performance necessary for workclass systems. Since this application is still in process, there is no assurance that the patent application will be accepted in its present form and may require adjustments to the present claims.

Nauticus Robotics has also filed for protection of our Company name and brand under trademark registration in the United States.

Legal Proceedings

Nauticus Robotics is not engaged in any legal proceedings and there is no legal action anticipated by the company.

Human Capital

Currently, Nauticus employs 90 personnel. These employees can be categorized into the following groups:

• Management:	13
• Business Administration:	10
• Business Development:	3
• Mechanical Engineering:	10
• Electrical Engineering:	6
• Software Engineering:	25
• Technicians:	17
• Interns:	6

Facilities

We operate in a corporate and manufacturing facility in Webster, Texas, USA. We currently occupy a facility that has approximately 30,000 square feet of office, development, and manufacturing space pursuant to a lease that, under options to extend, we expect to expire in April, 2024. Should we need additional space, we believe we will be able to obtain additional space on commercially reasonable terms.

MANAGEMENT'S DISCUSSION AND ANALYSIS OF FINANCIAL CONDITION AND RESULTS OF OPERATIONS OF NAUTICUS

The following discussion and analysis provide information that Nauticus' management believes is relevant to an assessment and understanding of Nauticus' results of operations and financial condition. The discussion should be read together with "Selected Historical Financial and Operating Data of Nauticus," the historical audited annual financial statements as of and for the years ended December 31, 2021 and 2020, the unaudited interim condensed financial statements as of March 31, 2022 and 2021 and for the three months ended March 31, 2022 and 2021, and the related respective notes thereto, included elsewhere in this proxy statement/prospectus. The discussion and analysis should also be read together with Nauticus' unaudited pro forma financial information for the year ended December 31, 2021 and the three months ended March 31, 2022. See "Unaudited Pro Forma Condensed Financial Information." This discussion may contain forward-looking statements based upon Nauticus' current expectations, estimates and projections that involve risks and uncertainties. Actual results could differ materially from those anticipated in these forward-looking statements due to, among other considerations, the matters discussed under "Risk Factors" and "Cautionary Note Regarding Forward-Looking Statements." Unless the context otherwise requires, all references in this section to "we," "our," "us" or "Nauticus" refer to the business of Nauticus Robotics, Inc., a Texas corporation, prior to the consummation of the Business Combination, which will be the business of the Post-Combination Company and its subsidiaries following the consummation of the Business Combination.

Overview

Nauticus Robotics provides 21st century ocean robotic solutions to combat the global impacts on the world's marine environment. The interconnected, purpose-built product ecosystem of both surface and subsea robots is powered by Nauticus' autonomous software platform that affords our robots real machine intelligence, not just automation. This approach will transform the industry to an economically efficient and environmentally sustainable model.

Nauticus Robotics, Inc. (Nauticus) was initially incorporated as Houston Mechatronics, Inc. on March 27, 2014 in the State of Texas. Nauticus's principal corporate offices are located in Webster, Texas. The Company is developing an ecosystem of subsea robots that are controlled through an AI-driven cloud software platform which enables a sliding scale spectrum of autonomous operations — from direct operator control to complete hands-off, robot self-sufficient control. Instead of the conventional tethered connection between the operator and the subsea robot, Nauticus has developed an acoustic communication networking, compression, and protocols that allows the robot to perform its tasks without a direct, cabled connection, this offering permits significant operational flexibility and cost savings over the methods currently deployed in the marketplace. The full range of Nauticus subsea robot technologies combine to provide unique capabilities heretofore not seen in the commercial subsea market and delivered to the market at substantially reduced cost and environmental footprint.

The array of products and services provided by Nauticus and vigorous company's strategy will disrupt the current subsea service paradigm through the introduction and integration of advanced robotic technologies. These key technologies are autonomous platforms, acoustic communications networks, electric manipulators, AI-based perception and control software, and high-definition workspace sensors. Implementation of these technologies enables substantially improved operations at significantly reduced costs over conventional methods.

Our business is organized into one single operating segment in providing technical and engineering services and products for use offshore. Nauticus provides robotic systems as part of product and services and delivered to primarily commercial and government customers.

Business Combination and Public Company Costs

On December 16, 2021, Nauticus entered into a Merger Agreement with CleanTech and Merger Sub pursuant to which, among other things, Merger Sub will merge with and into Nauticus, with Nauticus surviving the merger and becoming a wholly owned direct subsidiary of CleanTech. Thereafter, Merger Sub will cease to exist and CleanTech will be renamed Nauticus Robotics, Inc.. Nauticus will be deemed the accounting predecessor and the Post-Combination Company will be the successor SEC registrant, which means that Nauticus' financial statements for previous periods will be disclosed in the Post-Combination Company's future periodic reports filed with the SEC.

The Business Combination is anticipated to be accounted for as a reverse recapitalization. Under this method of accounting, CleanTech will be treated as the acquired company for financial statement reporting purposes. The most significant change in the Post-Combination Company's future reported financial position and results are expected to be

an estimated increase in cash (as compared to Nauticus' balance sheet at December 31, 2021) of between approximately \$50.2 million, assuming maximum stockholder conversions permitted under the Business Combination Agreement, and \$224.5 million, assuming no stockholder redemptions. Total non-recurring transaction costs are estimated to be approximately \$21.7 million, of which Nauticus expects approximately \$1.4 million to be expensed as part of the Business Combination and recorded in accumulated deficit, and the remaining approximately \$20.2 million was determined to be equity issuance costs and offset to additional-paid-in-capital. See "Unaudited Pro Forma Condensed Combined and consolidated Financial Information."

Upon closing of the Business Combination, it is expected that the PostCombination Company will continue to be listed on the NASDAQ and trade under the ticker symbol "KITT." As a majority of Nauticus' current management team and business operations will comprise the Post-Combination Company's management and operations, the Post-Combination Company will need to hire additional personnel and implement procedures and processes to address public company regulatory requirements and customary practices. Nauticus expects the Post-Combination Company will incur additional annual expenses as a public company for, among other things, directors' and officers' liability insurance, director fees and additional internal and external accounting, legal and administrative resources, including increased audit and legal fees.

Key Factors Affecting Nauticus' Operating Results

Nauticus believes that its future performance and success depends to a substantial extent on its ability to capitalize on the following opportunities, which in turn is subject to significant risks and challenges, including those discussed below and in the section of this proxy statement/prospectus entitled "Risk Factors."

Pricing, Product Cost and Margins. Our pricing and margins will depend on market response to Nauticus' innovative approach to subsea Inspection, Maintenance, and Repair ("IMR") operations. This new and disruptive approach utilizes a substantially reduced infrastructure that is afforded by the implementation of AI technologies and acoustic, non-cabled communications system between the surface vessel and the subsea robotic vehicle. Nauticus will leverage its significantly reduced cost posture to provide reduced services pricing to the market while retaining current market margins. The technologies employed by Nauticus enable pricing flexibility across our various markets that improve competitive stature and enhance market acceptance.

Nauticus believes it has the opportunity to establish high margin unit economics while scaling the business to a global enterprise. Nauticus' future performance will depend on our ability to deliver on the cost savings brought by advanced automation applied to subsea robotics. The reductions in manned labor cost in maritime operations combined with substantially reduced carbon footprint from smaller surface vessels yields lower operational costs that will enable widespread industry adoption. The Nauticus business model is well-positioned for scalability due to the ability to leverage the same product platform across multiple markets where enhancements developed for one market can be applied across the service fleet to other markets.

Nauticus expects to achieve and maintain high margins on its IMR services and vehicle sales offerings, however, macroeconomics conditions within the target industries as well as the emergence of competition with similar technical approaches may place downward pressure on pricing, margins, and market share. Reduced pricing and lower margins are typically associated with commodity products and services, Nauticus believes its unique technology complement provides a compelling value proposition for favorable margins and unit economics in the target markets. Should Nauticus fail to deliver market-ready autonomous and semi-autonomous capability in its subsea and surface vehicles in the planned market opportunity window, Nauticus may be required to raise additional debt or equity capital, which may not be available or may only be available on terms that are onerous to Nauticus' Stockholders.

Commercialization of autonomous/semi-autonomous subsea robotic service vehicles. We believe that the market for subsea services can be disrupted through new technical approaches that offer cost savings to the customer and reducing the impact on the environment. However, the pace of market adoption of these technologies may not be linear and may fluctuate on a quarterly basis, at least over the near term. As market acceptance matures, these fluctuations will reduce and the recurring nature of Nauticus' business model will stabilize revenue growth.

Nauticus expects to commercially launch its RaaS business model to the public at large by the end of 2022. To date, our product sales have been for HaloGuard, a red zone monitoring solution we developed. As of the date of this proxy statement/prospectus, Nauticus Robotics intends to quickly phase out the HaloGuard product, which

process is underway. This shift in our revenue sources causes our reported financial information not to be indicative of future operating results or financial condition. A delay in the delivery and readiness of our core products or reduced commercial interest in the RaaS subscription model could delay or limit the generation of revenue.

Sales Volume. Each of the products that Nauticus will sell to its customers in the target markets has a projected sales volume, pricing, and cost which factors in our view of the market acceptance and the delivery capacity of Nauticus. These projections depend on several factors, including market adoption of new technology-based approaches, Nauticus product capabilities, and the ability of Nauticus to meet market demand. In addition to end market demand, sales volumes will also depend on macroeconomic factors affecting our target industries. In certain cases, we may provide discounts or strategic customer pricing on sales of our products which in turn could adversely impact our gross margins. Nauticus' ability to achieve profitability is dependent upon market acceptance, penetration, and increasing market share. Delays in market acceptance of the new Nauticus service paradigm could result in Nauticus being unable to achieve its revenue targets and profitability over the course of these projections.

Our operating results are impacted by our ability to manage costs and expenses while achieving a balance between making appropriate investments to grow revenue while driving increased profitability. Cost and expense management will have a direct impact on our financial performance. We look to drive revenue growth through investments in marketing, technology, collaboration agreements with key partners, product and service offerings and ultimately market share. These efforts will need to be weighed against creating a more cost-efficient business to reduce operating expenses as a percentage of revenue.

Impact of COVID-19 Pandemic on Business — The global spread of COVID-19 has created significant market volatility and economic uncertainty and disruption during 2020. The Company was adversely affected by the deterioration and increased uncertainty in the macroeconomic outlook as a result of the impact of COVID-19. We continue to actively monitor the situation and may take further actions altering our business operations that we determine are in the best interests of our employees, customers, suppliers, and stakeholders, or as required by federal, state, or local authorities.

Components of Results of Operations

Revenue

The Company's primary sources of revenue are from providing technology and engineering services and products to the offshore industry and governmental entities. Revenue is generated pursuant to contractual arrangements to design and develop subsea robots and software and to provide related engineering, technical, and other services according to the specifications of the customers. These contracts can be service sales (cost plus fixed fee and firm fixed fee) or product sales.

Costs and Expenses

Cost of revenue

Cost of revenue principally includes direct material, direct labor and allocation of overhead associated with product development operations. Cost of revenue also includes the direct cost and appropriate allocation of overhead involved in execution of non-recurring engineering and technology services. Nauticus' cost of revenue is expected to increase as its revenue continues to grow as customers reach commercialization.

Depreciation

Depreciation costs are related to the depreciation of the Company's property and equipment which consists of leasehold improvements, equipment, and technology.

Research and development

Nauticus' research and development efforts are focused on enhancing and developing additional functionality for its existing products and on new product development. Research and development expenses consist primarily of:

- Personnel-related expenses, including salaries, benefits, and stock-based compensation expense, for personnel in Nauticus' research and engineering functions; and
- Expenses related to materials, software licenses, supplies and third-party services.

[Table of Contents](#)

Nauticus expenses research and development costs as incurred. Nauticus expects its research and development costs to increase for the near future as it continues to invest in research and development activities to achieve its product roadmap.

General and administrative expenses

General and administrative expenses consist of personnel and personnel-related expenses, including stock-based compensation of Nauticus' executive, finance, and information systems functions, as well as legal and accounting fees for professional and contract services. Nauticus expects its general and administrative expenses to increase for the near future as it scales headcount with the growth of its business, and as a result of operating as a public company, including compliance with the rules and regulations of the SEC, legal, audit, additional insurance expenses, investor relations activities, and other administrative and professional services.

General and administrative expenses also include selling and marketing expenses which consists of personnel and personnel-related expenses, including stock-based compensation of Nauticus business development team as well as advertising and marketing expenses. These include the cost of trade shows, promotional materials, and public relations. Nauticus expects to increase its sales and marketing activities, expand customer relationships, and increase market share. Nauticus also expects that its sales and marketing expenses will increase over time as it continues to hire additional personnel to scale its business.

Other income and expense

Other income and expense consist primarily of gain/(loss) on disposition of assets, miscellaneous non-operating income, miscellaneous receipts and reimbursements, and the forgiveness of loans pursuant to the SBA Paycheck Protection Program.

Interest expense (income), net

Interest expense (income), net consists primarily of income earned on Nauticus' cash equivalents, investments in marketable securities, and interest incurred on the Company's indebtedness. These amounts will vary based on Nauticus' cash, cash equivalents and short-term investment balances as well as any changes in market rates.

Results of Operations**Comparison of the Three Months Ended March 31, 2022 and 2021**

The results of operations presented below should be reviewed in conjunction with the financial statements and notes included elsewhere in this prospectus. The following table sets forth summarized consolidated financial information for the three months ended March 31, 2022 and 2021:

	Three Months Ended March 31,		Change \$	Change %
	2022	2021		
Revenue				
Service	\$ 2,235,965	\$ 161,478	\$ 2,074,487	1285%
Service – related party	—	141,265	(141,265)	(100)%
Total revenue	2,235,965	302,743	1,933,222	639%
Costs and Expenses				
Cost of revenue (exclusive of items shown separately below)	1,899,161	698,888	1,200,273	172%
Depreciation	111,319	87,716	23,603	27%
Research and development	1,267,412	1,202,718	64,694	5%
General and administrative	1,646,041	659,706	986,335	150%
Total costs and expenses	4,923,933	2,649,028	2,274,905	86%
Operating loss	(2,687,968)	(2,346,285)	(341,683)	15%
Other income	14,060	(888,153)	(902,213)	102%
Interest expense, net	801,974	61,550	740,424	1203%
Net loss	\$ (3,504,002)	\$ (1,519,682)	\$ (1,984,320)	131%

[Table of Contents](#)

Revenue

Revenue increased by \$1.9 million, or 639%, to \$2.2 million for the three months ended March 31, 2022, from \$0.3 million for the same period of 2021. The increase in revenue is attributed to the addition of revenue from three service contracts, including the continued lease of an Aquanaut vehicle during 2022.

Costs and expenses

Cost of revenue

Cost of revenue increased by \$1.2 million, or 172%, to \$1.9 million in the first quarter of 2022, from \$0.7 million for the comparable period of 2021. The increase in cost of revenue is attributed to the addition of three service contracts.

Depreciation

Depreciation increased by \$24 thousand, or 27%, to \$111 thousand for the three months ended March 31, 2022, from \$88 thousand for the same period of 2021 primarily due to facility upgrades during first quarter 2022.

Research and development

Total research and development expenses increased by \$0.1 million, or 5%, to \$1.3 million for the three months ended March 31, 2022, from \$1.2 million for the same period of 2021. The increase was due primarily to product and software research and development activities.

General and administrative

Total general and administrative expenses increased by \$1.0 million, or 150%, to \$1.7 million for the three months ended March 31, 2022, from \$0.7 million for the same period of 2021. General and administrative expenses increased primarily due to an increase in company headcount, professional fees and other costs incurred in preparation for the business combination transaction with CleanTech.

Other income expense, net

Other income decreased by \$902,000 to an expense of \$14,000 for the three months ended March 31, 2022 from \$888,000 of income in the same period of 2021. The decrease was due primarily to the recognition of the Paycheck Protection Program or (PPP) loan during the first quarter of 2021.

Interest expense, net

Interest expense, net increased by \$740 thousand to \$802 thousand for the three months ended March 31, 2022 from \$62,000 in the same period of 2021. Interest expense, net increased due to an increase in indebtedness during the fourth quarter of 2021.

Comparison of the Years Ended December 31, 2021 and 2020

The results of operations presented below should be reviewed in conjunction with the financial statements and notes included elsewhere in this prospectus. The following table sets forth Nauticus' results of operations data for the periods presented:

	Year ended December 31,		Change \$
	2021	2020	
Revenue			
Service	\$ 7,854,068	\$ 3,184,629	\$ 4,669,439
Product	242,637	—	242,637
Service – related party	332,767	619,883	(287,116)
Product – related party	162,068	189,928	(27,860)
Total revenue	8,591,540	3,994,440	4,597,100
Costs and Expenses			
Cost of revenue (exclusive of items shown separately below)	6,850,248	4,059,991	2,790,257
Depreciation	365,097	400,432	(35,335)
Research and development	3,533,713	4,951,619	(1,417,906)
General and administrative	4,362,400	3,319,455	1,042,945
Total costs and expenses	15,111,458	12,731,497	2,379,961
Operating loss	(6,519,918)	(8,737,057)	2,217,139
Other income	(1,601,568)	(1,609,962)	(8,394)
Loss on extinguishment of debt	9,484,113	—	(9,484,113)
Interest expense, net	725,166	66,943	658,223
Net loss	\$ (15,127,629)	\$ (7,194,038)	\$ (7,933,591)

Revenue

Revenue increased by \$4.6 million, or 115%, to \$8.6 million for 2021, from \$4.0 million for 2020. The increase in revenue is attributed to the addition of revenue from three service contracts, including the lease of an Aquanaut vehicle, during 2021. Revenue decreased by \$1.8 million, or 31%, to \$4.0 million for 2020, from \$5.8 million for 2019. The decrease in revenue is attributed to the completion of various projects during 2019 which accounts for \$2.7 million of the decrease and a reduction in sales from 2019 to 2020 of \$1.2 million to a related party, Transocean Inc., due to lower demand of HaloGuard product and related services. These decreases are offset by an increase in revenue from 2019 to 2020 related to a new sales agreement executed at the end of 2019 resulting in \$2.0 million of revenue in 2020.

Cost of Revenue

In fiscal year 2020, the Cost of Revenue exceeded Revenue, a trend which was subsequently reversed in fiscal year 2021 (as shown in the chart above). The causes related to the Cost of Revenue exceeding the total Revenue for fiscal year 2020 is directly related to the reduction in revenue associated with the COVID-19 pandemic and the retention of overhead staffing levels during this fiscal period. Nauticus Robotics was the recipient of the Paycheck Protection Program loan and used these funds to maintain staffing levels. The downturn in the commercial energy markets combined with the completion of and subsequent delays in the continuation of a defense related program resulted in a reduction in Revenue. The Cost of Revenue reflects the higher costs incurred by Nauticus Robotics by maintaining staffing levels in comparison to the reduced income experienced during fiscal year 2020.

In fiscal year 2021, follow-on defense contracts were awarded and the energy markets recovered leading to an increase in Revenue. Overhead staffing levels were maintained at 2020 levels but provided a better match to the improved revenue. These market trends are the reason why 2020 Cost of Revenue exceeds total Revenue and why it recovered as the pandemic effects were mitigated.

Products and Services

Historically, Nauticus has generated revenue through engineering service contracts while concomitantly investing internal resources toward the product development of its subsea robotics portfolio. These previously developed products are now, in 2022, emerging into a revenue generating status. The revenue chronology for Nauticus' contract history is shown in the table below.

The Jacobi Motors service contract began in 2018 to assist in the development of an electric motor targeted for the electric motor market. This contract was completed in 2020. The beginning of the U.S. Department of Defense programs that Nauticus is currently participating in, each supporting the advancement in autonomy in subsea vehicles, was started in 2018 and continued to 2019. This effort gave rise to the larger program in 2019, with contractual milestones completed in 2020 and continuing to this day. The Office of Naval Research funded an effort with Aquanaut for more dexterous subsea manipulation activities and hardware in 2019 and 2020. Transocean, the lead investor for the Series B investment round, co-funded some product development activities for automated drill pipe handling (Spiral) and for a zone monitoring safety system (THEIA/HaloGuard). Although the Spiral project was completed in 2019, the HaloGuard system has been deployed to four (4) offshore drilling ships to enhance drill floor safety.

Current contracts support Nauticus' core subsea vehicle products — Aquanaut and Argonaut. Nauticus has work ongoing with a Large Confidential Government Contractor for the manufacturing and commissioning of Argonaut, an Aquanaut-variant aimed specifically for U.S. defense and intelligence missions. The project was awarded to the joint team of a Large Confidential Government Contractor and Nauticus team in 2021 with the initial phase milestone running through December 2022. As part of the effort, the Aquanaut is leased to the program to support data collection and autonomous subsea manipulation operations; therefore generating revenue. In 2022, Nauticus' Hydronaut surface vessel also generates revenue in support of the Aquanaut. Other Nauticus products currently generating revenue in 2022 also include the Olympic Arm (electric subsea manipulators), with the delivery of the first article to IKM Subsea expected in the second quarter of 2022, and ToolKIT, which is licensed as software to IKM Subsea and used in with the Defense Innovation Unit.

Nauticus' project backlog includes continued work on a project under a subcontract to our partner, a Large Confidential Government Contractor, through 2022. Phase 2 of this project begins in January 2023 and will run for approximately 18 months. This next phase of the project includes an option to purchase an Argonaut vehicle. The Defense Innovation Unit contract will continue through 2022 and into 2023. Other items in the sales pipeline include Olympic Arm sales, commercial subsea service opportunities in the North Sea in late 2022 or early 2023, and a contract opportunity for maritime environmental surveillance using an Aquanaut with the Singaporean government.

Among the other items in the pipeline, Nauticus has also tendered a bid, in partnership with Schlumberger in Brazil, for work with Petrobras. Possible award for that multiyear/multimillion dollar contract is imminent. Nauticus is also under contract with Shell and progressing toward a service contract pilot in the Gulf of Mexico for fall 2022. Additionally, in April 2022, Nauticus signed a Memorandum of Understanding with Wood, Plc, an engineering and consulting firm in the United Kingdom for the purpose of jointly pursuing subsea inspection services for oil & gas and wind markets. Pursuant to the Memorandum of Understanding agreement, each party will utilize its expertise and capabilities to deliver subsea inspection services to specific targeted markets.

Lastly, Nauticus recently announced its intention to launch a "robotic navy" comprised of Hydronaut and Aquanaut pairs, which publicized Nauticus' strategic plans to grow its commercial services fleet to markets in the North Sea, offshore Brazil, and the Asian-Pacific region. This initiative is part of an overall financial plan, which includes the production of these units in order to perform subsea services in strategically important regions around world. Nauticus is currently working with legal and financial firms in the United Kingdom to assist in the development of a regional operations center in Aberdeen, Scotland, United Kingdom as well as in Norway. In 2023, Nauticus plans to expand operations in Brazil as part of an opportunity presented through Petrobras. In 2024, the opening of an operations center in Singapore is planned to provide a logistics and operations hub for the Asia-Pacific market. The Houston office plans to support Gulf of Mexico operations as they develop over the near term.

HaloGuard

The HaloGuard product is a red-zone safety monitoring system that utilizes methods derived from robotic perception to locate and identify individuals that have crossed into a designated safety zone. If the individual that has entered a designated safety zone is not authorized for that entry, an alarm will alert the operator. The system is capable of not only warning the operator through audible alarms and computer displays but is also capable of shutting down equipment moving in the safety zone. The HaloGuard is comprised of a network of perception sensors (cameras and

[Table of Contents](#)

time of flight sensors that measure distance to objects), an electronics rack for housing the computer system, and the HaloGuard software that includes the user displays and integrates the elements together to form the functioning safety system. The purpose of this system is to improve the safety of human workers in and around hazardous equipment.

In terms of process and performance obligation, after the HaloGuard components are assembled, the equipment is set up in a test area at Nauticus Robotics. The customer inspects the components, and a functional checkout of the system is performed. The customer then accepts the product and takes ownership of the HaloGuard system. It is at this point that the “title and risk of loss” passes onto our customers. Nauticus Robotics stores the equipment until arrangements for installation of the HaloGuard on the drilling rig have been put in place. Nauticus Robotics dispatches trained personnel to go to the drilling rig and install the HaloGuard. Installation services are billed to the customer when performed and accepted by the customer.

At Nauticus, the HaloGuard product was initially developed under funding from Transocean and shown in the table below as “THEIA” in 2019. After this initial funding, Nauticus Robotics assumed the cost of further development. After completion of the first system, Transocean ordered 7 separate installations on their drilling rigs and this revenue is shown in the table below as “Transocean — HaloGuard”. In 2020, the HaloGuard was installed on the first Transocean drilling rig for testing and final acceptance. Subsequently, the HaloGuard was installed on 3 additional drilling rigs. The installation schedule was delayed due to the downturn in the energy market during the first year of the pandemic. As these systems have been installed, various purchase orders were negotiated with Transocean to improve the HaloGuard system, effect repairs, perform maintenance, etc. These revenues are shown in the table below as “Transocean NRE and Other”. Work under these contracts funded ongoing product support and maintenance at Nauticus Robotics. Recently, Nauticus Robotics delivered a computer rack, alarm tower, and provided five (5) perception sensors for Salunda for installation (by Salunda) at a customer site. That revenue is shown in the table below as “HaloGuard — Salunda”.

Contract terms for sales of this product to Transocean has been structured as a purchase of the various hardware and software elements of the system. Costs for installation and support are billed to Transocean separately.

As of the date of this prospectus, Nauticus Robotics intends to quickly phase out this product, which process is underway. As HaloGuard is a small market adjacency that was primarily executed as directed by Transocean, we are in the process of discontinuing our support relationship with this product and any further development. Nauticus has ceased all new operations with the product HaloGuard as of the beginning of the fiscal year 2022, and Nauticus will not have any legacy obligation to support this product after it is phased out.

Nauticus Revenue Generation by Service and Product Contract

Product/Contract	2021	2020	2019	Reason for Change
Jacobi Motors	—	69,029	1,276,758	Completed in 2020
DARPA	—	—	204,561	Completed in 2019
Exxon	—	—	140,000	Completed in 2019
Large Confidential Government Contractor	—	2,440,600	418,805	Completed in 2020 – Transition to project in 2021
Office of Naval Research	—	675,000	847,693	Completed in 2020
Transocean – HaloGuard	162,068	619,883	1,647,910	Fewer Orders Placed
Spiral	—	—	733,726	Completed in 2019
Transocean NRE and Other	332,767	189,928	122,963	Performed On As Needed Basis
Other	—	—	10,000	Performed On As Needed Basis
THEIA	—	—	420,377	Completed in 2019
Defense Innovation Unit	182,811	—	—	New Client in 2021
HaloGuard – Salunda	242,637	—	—	New Client in 2021
Large Confidential Government Contractor	2,614,221	—	—	Started in 2021
Large Confidential Government Contractor – Aquanaut Charter	756,666	—	—	Part of government contract
Large Confidential Government Contractor – Argonaut	4,300,370	—	—	Began Work in 2021
Total	8,591,540	3,994,440	5,822,793	

Costs and expenses

Cost of revenue

Cost of revenue increased by \$2.8 million, or 69%, to \$6.9 million for 2021, from \$4.1 million for 2020. The increase in cost of revenue is attributed to the addition of three service contracts for 2021.

Depreciation

Depreciation decreased by \$35 thousand, or 9%, to \$365 thousand for 2021, from \$400 thousand for 2020 due to the aging of selected categories of fixed assets during 2021.

Research and development

Total research and development expenses decreased by \$1.4 million, or 29%, to \$3.5 million for 2021, from \$5.0 million for 2020. The decline was due primarily to a reduction in overall research and development activity.

General and administrative

Total general and administrative expenses increased by \$1.0 million, or 31%, to \$4.4 million for 2021, from \$3.3 million for 2020. General and administrative expenses increased primarily due to an increase in Company activity and professional and other costs related to the filing of Form S-4.

Other income

Other income decreased by \$8 thousand to \$1.6 million for 2021 from \$1.6 million in 2020. The decrease was due primarily to the reduction in other miscellaneous receipts and refunds.

Loss on Extinguishment of Debt

The Company recognized a loss on extinguishment of debt of \$9.5 million for 2021 due to an amendment of outstanding contingently convertible notes to allow the notes to be converted into Nauticus common stock as of the closing date of the Business Combination between CleanTech and Nauticus. The amendment was treated as an accounting extinguishment of debt. A loss was recognized for the difference between the carrying amounts of the notes and their fair values as of the date the notes were modified.

Interest expense, net

Interest expense, net increased by \$0.6 million to \$0.7 million for 2021 from \$0.1 million in 2020. Interest expense, net increased due to an increase in indebtedness during 2021.

Liquidity and Capital Resources

Sources of Liquidity

Nauticus' capital requirements will depend on many factors, including sales volume, the timing and extent of spending to support R&D efforts, investments in technology, the expansion of sales and marketing activities, and market adoption of new and enhanced products and features. As of March 31, 2022, Nauticus had cash and cash equivalents totaling \$15.1 million. The cash equivalents consist of money market funds. To date, Nauticus' principal sources of liquidity have been proceeds received from the issuance of debt, equity funding from its principal owners and cash flow from operations.

Until Nauticus can generate sufficient revenue from its sales of subsea robots, services, and software to cover operating expenses, working capital and capital expenditures, Nauticus expects funds raised in a Business Combination from a merger agreement with CleanTech Acquisition Corporation, a special purpose acquisition company, including

[Table of Contents](#)

the PIPE private placement, to fund cash needs. Any equity securities issued may provide for rights, preferences, or privileges senior to those of holders of the Post-Combination Company's common stock subsequent to the Business Combination. If Nauticus raises funds by issuing debt securities, these debt securities would have rights, preferences, and privileges senior to those of holders of Nauticus Common Stock. The terms of debt securities or borrowings could impose significant restrictions on Nauticus' operations. The credit market and financial services industry have in the past, and may in the future, experience periods of uncertainty that could impact the availability and cost of equity and debt financing.

Nauticus incurred negative cash flows from operating activities and losses from operations in the past as reflected in its accumulated deficit of \$43.3 million as of March 31, 2022. Nauticus had total current assets of \$18.4 million and total current liabilities of \$16.7 million as of March 31, 2022. Management believes cash on-hand, including the funds raised in the Business Combination, together with revenue from the Company's existing and new contracts will be sufficient to meet its obligations for at least one year from the filing date of this document.

Cash Flow Summary

The following table summarizes our cash flows for the periods presented:

	Year ended December 31,		Three months ended March 31,	
	2021	2020	2022	2021
Net cash provided by (used in):				
Operating activities	\$ (5,923,190)	\$ (4,499,775)	\$ (4,200,250)	\$ (2,314,957)
Investing activities	\$ (922,487)	\$ 996,482	\$ (1,675,238)	—
Financing activities	\$ 24,500,364	\$ 2,539,909	—	\$ 1,459,661

Operating Activities

For the year ended December 31, 2020, net cash used in operating activities was \$4.5 million. The primary factors affecting Nauticus' operating cash flows during this period were Nauticus' net loss of \$7.2 million, offset by a customer advance of \$1.8 million, non-cash expenses of depreciation and amortization of \$0.4 million and stock-based compensation of \$0.4 million, the non-cash impact of lease accounting implementation of \$0.2 million, and net cash outflows of \$0.2 million from changes in operating assets and liabilities.

For the year ended December 31, 2021, net cash used in operating activities was \$5.9 million. The primary factors affecting Nauticus' operating cash flows during this period were its net loss of \$15.1 million offset by the noncash loss of \$9.5 million related to extinguishment of debt, non-cash expenses of stock-based compensation of \$0.4 million, depreciation expense of \$0.4 million, a \$2.3 million increase in accounts payable and accrued liabilities and a \$1.4 million reduction in contract liabilities.

For the three months ended March 31, 2022, net cash used in operating activities was \$4.2 million. The primary factors affecting Nauticus' operating cash flows during this period were its net loss of \$3.5 million offset by non-cash expenses for stock-based compensation of \$0.2 million, depreciation expense of \$0.1 million, amortization of debt discount of \$0.2, a \$0.4 million increase in accounts payable and accrued liabilities and a \$0.4 million reduction in contract liabilities.

Investing Activities

For the year ended December 31, 2020, net cash provided by investing activities was \$1.0 million primarily due to the proceeds from short-term investments.

For the year ended December 31, 2021, net cash used in investing activities was \$0.9 million due to the purchase of equipment.

For the three months ended March 31, 2022, net cash used in investing activities was \$1.7 million due to the purchase of property and equipment.

Financing Activities

For the year ended December 31, 2020, net cash provided by financing activities was \$2.5 million. The primary factor affecting Nauticus' financing cash flows during this period were proceeds from a notes payable of \$3.0 million offset by payments of notes payable of \$0.5 million.

For the year ended December 31, 2021, net cash provided by financing activities was \$24.5 million. The primary factor affecting Nauticus' financing cash flows during this period were proceeds from a notes payables of \$25.0 million offset by payments on notes payable of \$0.5 million.

For the three months ended March 31, 2022, the Company had no net cash provided by or used for financing activities.

Contractual Obligations

Contingently Convertible Promissory Note

The following promissory notes were amended as of December 16, 2021 to allow the note to be converted into Nauticus common stock as of the closing date of the Business Combination between CleanTech and Nauticus. The notes also include an option permitting the notes to be converted into shares of preferred stock in the event of an additional financing by Nauticus. More information about each of these notes is included in Note 4 to Nauticus' financial statements for the years ended December 31, 2021 and 2020 included elsewhere in this filing.

Schlumberger Technology Corp. Contingently Convertible Promissory Note — In July 2020, the Company issued an unsecured convertible promissory note to Schlumberger Technology Corp. in the amount of \$1,500,000, bearing interest at 4.25%, and was amended to extend the maturity date to December 31, 2022.

Transocean Inc. Contingently Convertible Promissory Note — In December 2020, the Company issued an unsecured convertible promissory note to Transocean Inc. in the amount of \$1,500,000, bearing interest at 10%, and was amended to extend the maturity date to December 31, 2022.

Goradia Capital, LLC Contingently Convertible Promissory Note — On June 19, 2021, the Company issued an unsecured convertible promissory note to Goradia Capital, LLC in the amount of \$5,000,000, bearing interest at 10%, and maturing on December 31, 2022.

Material Impact Fund II, L.P. Contingently Convertible Promissory Note — On August 3, 2021, the Company issued an unsecured convertible promissory note to Material Impact Fund II, L.P. in the amount of \$5,000,000, bearing interest at 5%, and maturing on December 31, 2022.

In-Q-Tel, Inc. Contingently Convertible Promissory Note — On October 22, 2021, the Company issued an unsecured convertible promissory note to In-Q-Tel, Inc. in the amount of \$250,000, bearing interest at 5%, and maturing on December 31, 2022.

Term Loan Credit Agreement

RCB Equities #1, LLC Term Loan Credit Agreement — On December 16, 2021, the Company entered into a Term Loan Credit Agreement with RCB Equities #1, LLC ("RCB") in the amount of \$15,000,000 to provide funds for the Company's working capital and general corporate purposes. The note bears interest at 13% per annum and is payable in 18 monthly installments of interest only through its maturity date of June 16, 2023. A 2% commitment fee totaling \$300,000 was paid upon loan inception and is presented as a debt discount. There is also a 5% exit fee totaling \$750,000 is payable at the maturity date and is being accrued over the note term. The effective interest rate on the loan is approximately 17.7%.

Leases

The Company leases its office and manufacturing facility under a 64-month operating lease expiring April 30, 2024. The lease includes rent escalations and chargebacks to the Company for build-out costs. The right-of-use asset and lease liability amounts were determined using an 8% discount rate which was the interest rate related to the leasehold improvement obligation. More information about each of this lease is included in Note 6 to Nauticus' financial statements for the years ended December 31, 2021 and 2020 included elsewhere in this filing.

Off-Balance Sheet Arrangements

As of March 31, 2022, Nauticus has not engaged in any offbalance sheet arrangements, as defined in the rules and regulations of the SEC.

Related Party Transactions

As of March 31, 2022, Schlumberger owns 30% and Transocean owns 31% of the stock of Nauticus. See section above related to Contingently Convertible Promissory Notes above for more detail. In 2020, HMI issued convertible promissory notes to Schlumberger and Transocean, each with an amount of \$1,500,000.

There are revenues, accounts receivable balances, and contract asset amounts from Transocean. Refer to Note 11 — *Related Party Transactions* in Nauticus' financial statements for the years ended December 31, 2021 and 2020 and Note 9 in Nauticus' financial statements for the three months ended March 31, 2022 and 2021 included elsewhere in this filing for more details.

Critical Accounting Policies and Estimates

Nauticus prepares its financial statements in accordance with U.S. GAAP. The preparation of these financial statements requires us to make estimates, assumptions and judgments that can significantly impact the amounts Nauticus reports as assets, liabilities, revenue, costs and expenses and the related disclosures. Nauticus bases its estimates on historical experience and other assumptions that it believes are reasonable under the circumstances. Nauticus' actual results could differ significantly from these estimates under different assumptions and conditions. Nauticus believes that the accounting policies discussed below are critical to understanding its historical and future performance as these policies involve a greater degree of judgment and complexity.

Stock-Based Compensation

Nauticus recognizes the cost of stock-based awards granted to its employees and directors based on the estimated grant-date fair value of the awards. Cost is recognized on a straight-line basis over the service period, which is the vesting period of the award. Nauticus elected to recognize the effect of forfeitures in the period they occur. Nauticus determines the fair value of stock options using the Black-Scholes option pricing model, which is impacted by the following assumptions:

- Expected Term — Nauticus uses the option's expected term
- Expected Volatility — As Nauticus' stock is not currently publicly traded, the volatility is based on a benchmark of comparable companies within the robotics and ROV technology industries.
- Expected Dividend Yield — The dividend rate used is zero as Nauticus has never paid any cash dividends on its common stock and does not anticipate doing so in the foreseeable future.
- Risk-Free Interest Rate — The interest rates used are based on the implied yield available on U.S. Treasury zero-coupon issues with an equivalent remaining term equal to the expected life of the award.

The grant date fair value of Nauticus Common Stock was determined using valuation methodologies which utilizes certain assumptions, including probability weighting of events, volatility, time to liquidation, a risk-free interest rate, and an assumption for a discount for lack of marketability (Level 3 inputs).

Based on Nauticus' early stage of development and other relevant factors, it was determined that an Option Pricing Model ("OPM"), specifically the Black-Scholes OPM, was the most appropriate method for allocating our enterprise value to determine the estimated fair value of Nauticus Common Stock. Application of the OPM involves

[Table of Contents](#)

the use of estimates, judgment, and assumptions that are highly complex and subjective, such as those regarding its expected future revenue, expenses, and cash flows, discount rates, market multiples, the selection of comparable companies, and the probability of future events.

Accounting Extinguishments of Debt

The December 16, 2021 modifications of the five contingently convertible notes discussed above were treated as extinguishments of debt for accounting purposes because the conversion options were considered substantive. A loss on the extinguishment of debt totaling \$9.5 million was recognized for the difference between the carrying amounts of the notes and their fair values as of the modification date. Because the fair values of the notes included a substantial premium above their face values and the contingently convertible options did not require bifurcation, the premium was recorded to additional paid-in capital.

The fair values of the contingently convertible notes were determined by an independent valuation specialist whose model considered the stated terms of the notes, the Company's effective borrowing rate for debt having similar terms and valuation of each of the convertible options. The conversion options were valued using the Black-Scholes option pricing model which is impacted by the following assumptions:

- Expected Term — Nauticus used the expected term of the Notes
- Expected Volatility — Since there is no public market for the Company's common stock, the expected volatility for options was determined based on a peer group of publicly traded companies. In evaluating similarity of this peer group, the Company considered factors such as stage of development, risk profile, enterprise value and position within the industry.
- Expected Dividend Yield — The dividend rate used is zero as Nauticus has never paid any cash dividends on its common stock and at the modification date had no plans to do so.
- Risk-Free Interest Rate — The risk-free rate was based on the U.S. Treasury yield curve in effect at the modification date for the time until maturity of the notes.
- CleanTech Stock Price — Nauticus used the publicly traded price of Cleantech's common stock at the modification date in valuing the conversion option in the event the merger is consummated.
- Nauticus Stock Price — Nauticus used the estimated fair value of the Company's common stock as of the modification date.

The Company referenced its recent term loan borrowing with RCB to estimate its effective borrowing rate for debt having similar terms. The effective rate used was 17.7%.

The fair values of each component of the contingently convertible notes were probabilistically weighted to determine the overall fair value of each note. This probability weighting considered the likelihood that the planned merger of Nauticus and Cleantech will be completed, the probability of additional financing as well as the probability of a cash repayment of the notes at maturity if the conversion options are not exercised.

Revenue Recognition

The Company's primary sources of revenue are from providing technology and engineering services and products to the offshore industry and governmental entities. Revenue is generated pursuant to contractual arrangements to design and develop subsea robots and software and to provide related engineering, technical, and other services according to the specifications of the customers. These contracts can be service sales (cost plus fixed fee or firm fixed fee) or product sales and typically have terms of up to 18 months. The Company has limited product sales as its core products are still under development. Product sales to date have been for HaloGuard, a red zone monitoring solution we developed.

A performance obligation is a promise in a contract to transfer distinct goods or services to a customer. The products and services in our contracts are typically not distinct from one another. Accordingly, our contracts are typically accounted for as one performance obligation.

[Table of Contents](#)

The Company's performance obligations under service agreements generally are satisfied over time as the service is provided. Revenue under these contracts is recognized over time using an input measure of progress (typically costs incurred to date relative to total estimated costs at completion). This requires management to make significant estimates and assumptions to estimate contract sales and costs associated with its contracts with customers. At the outset of a long-term contract, the Company identifies risks to the achievement of the technical, schedule and cost aspects of the contract. Throughout the contract term, on at least a quarterly basis, we monitor and assess the effects of those risks on its estimates of sales and total costs to complete the contract. Changes in these estimates could have a material effect on the Company's results of operations.

Cost plus fixed fee contracts are largely used for development projects.

Firm-fixed price contracts provide products or services generally over an agreed upon time frame for a predetermined amount. Firm-fixed price contracts present the risk of unreimbursed cost overruns, potentially resulting in lower-than-expected contract profits and margins. This risk is generally lower for cost plus fixed fee contracts which, as a result, generally have a lower margin.

Service revenue included equipment operating lease income in 2021 recognized based on the contractual cash lease payments for the period.

Performance obligations for product sales typically are satisfied at a point in time. This occurs when control of the products is transferred to the customer, which generally is when title and risk of loss have passed to the customer.

Contract assets include unbilled amounts typically resulting from sales under contracts when the cost-to-cost method of revenue recognition is utilized and revenue recognized exceeds the amount billed to the customer. Contract assets are recorded at the net amount expected to be billed and collected. Contract liabilities include billings in excess of revenue recognized and accrual of certain unsatisfied performance obligations.

Emerging Growth Company Status

Section 102(b)(1) of the JOBS Act exempts emerging growth companies from being required to comply with new or revised financial accounting standards until private companies are required to comply with the new or revised financial accounting standards. The JOBS Act provides that a company can choose not to take advantage of the extended transition period and comply with the requirements that apply to non-emerging growth companies, and any such election to not take advantage of the extended transition period is irrevocable.

CleanTech is an "emerging growth company" as defined in Section 2(a) of the Securities Act of 1933, as amended, and has elected to take advantage of the benefits of the extended transition period for new or revised financial accounting standards. Following the consummation of the Business Combination, the Post-Combination Company will remain an emerging growth company until the earliest of (i) the last day of the fiscal year in which the market value of CleanTech Common Stock that is held by non-affiliates exceeds \$700 million as of the end of that year's second fiscal quarter, (ii) the last day of the fiscal year in which the Post-Combination Company has total annual gross revenue of \$1.07 billion or more during such fiscal year (as indexed for inflation), (iii) the date on which the Post-Combination Company has issued more than \$1 billion in non-convertible debt in the prior three-year period or (iv) the last day of the fiscal year following the fifth anniversary of the IPO closing date, and the Post-Combination Company expects to continue to take advantage of the benefits of the extended transition period, although it may decide to early adopt such new or revised accounting standards to the extent permitted by such standards. This may make it difficult or impossible to compare the Post-Combination Company's financial results with the financial results of another public company that is either not an emerging growth company or is an emerging growth company that has chosen not to take advantage of the extended transition period exemptions because of the potential differences in accounting standards used.

Recent Accounting Pronouncements

See Note 2 to Nauticus' financial statements for the three months ended March 31, 2022 and 2021 included elsewhere in this proxy statement/prospectus for recently adopted accounting pronouncements and recently issued accounting pronouncements not yet adopted as of the date of this proxy statement/prospectus.

Internal Control Over Financial Reporting

Nauticus has identified a material weakness in its internal control over financial reporting. This material weakness could continue to adversely affect Nauticus' ability to report its results of operations and financial condition accurately and in a timely manner.

Nauticus management is responsible for establishing and maintaining adequate internal control over financial reporting designed to provide reasonable assurance regarding the reliability of financial reporting and the preparation of consolidated financial statements for external purposes in accordance with GAAP. Nauticus' management is likewise required, on a quarterly basis, to evaluate the effectiveness of its internal controls. Nauticus has identified a material weakness in its internal control over financial reporting, such that there is a reasonable possibility that a material misstatement of Nauticus' annual or interim financial statements will not be prevented or detected on a timely basis.

Nauticus identified certain deficiencies in internal control over financial reporting including a lack of segregation of duties within the accounting function and systems, and inadequate procedures for the accounting close process including obtaining information supporting significant accounting estimates and judgments affecting the financial statements on a timely basis. As a result, Nauticus management concluded that a material weakness existed in its internal control over financial reporting. As a result of this material weakness, Nauticus' management concluded that its internal control over financial reporting was not effective as of December 31, 2021.

To respond to this material weakness, Nauticus has devoted, and plans to continue to devote, significant effort and resources to the remediation and improvement of its internal control over financial reporting. Nauticus' plans are to employ additional finance and accounting personnel for key finance and accounting positions. We have identified other personnel and expect to secure their full-time employment within the next two months. In the interim until we achieve our full staffing complement, we have engaged a technical accounting and financial reporting consulting firm to assist us in our financial accounting close, the application of technical accounting literature, preparation of our financial statements and assistance with the independent audits and reviews of our financial statements. We have taken immediate steps to implement an appropriate segregation of duties within our accounting function and existing financial accounting systems. In 2022, we expect to complete implementation of a new enterprise resource planning system supporting day-to-day business activities including accounting, procurement, project management, supply chain and operations. Finally, we have taken steps to strengthen our financial close process and ensure information is obtained timelier to support preparation of our financial statements in accordance with U.S. GAAP.

We expect to incur on-going significant costs to meet the corporate governance provisions of the Sarbanes-Oxley Act of 2002, related regulations of the SEC and the requirements of the NASDAQ, with which we are not required to comply presently as a private company. Complying with these statutes, regulations and requirements will occupy a significant amount of time for our board of directors and management and will significantly increase our costs and expenses.

While we believe these actions will address the reported material weakness, we can give no assurance that these will remediate this deficiency in internal control or that additional material weaknesses or significant deficiencies in our internal control over financial reporting will not be identified in the future. Our failure to implement and maintain effective internal control over financial reporting could result in errors in our financial statements that could result in a restatement of our financial statements and cause us to fail to meet our reporting obligations.

Any failure to maintain such internal control could adversely impact Nauticus' ability to report its financial position and results from operations on a timely and accurate basis. If Nauticus' financial statements are not accurate, investors may not have a complete understanding of its operations. Likewise, if after the Business Combination, Nauticus' financial statements are not filed on a timely basis, Nauticus could be subject to sanctions or investigations by the stock exchange on which its common stock is listed, the SEC or other regulatory authorities. In either case, it could result in a material adverse effect on Nauticus' business. Ineffective internal controls could also cause investors to lose confidence in Nauticus' reported financial information which could have a negative effect on the trading of Nauticus stock.

[Table of Contents](#)

Nauticus can give no assurances that the measures it has taken and plans to take in the future will remediate the material weakness identified or that any additional material weaknesses or restatements of financial results will not arise in the future due to failure to implement and maintain adequate control over financial reporting or circumvention of these controls. In addition, even if Nauticus is successful in strengthening its controls and procedures, in the future those controls and procedures may not be adequate to prevent or identify irregularities or errors or to facilitate the fair preparation and presentation of our consolidated financial statements.

Quantitative and Qualitative Disclosures About Market Risk

Nauticus has not, to date, been exposed to material market risks given its early stage of operations. Upon the significant increase in commercial operations, Nauticus expects to be exposed to foreign currency translation and transaction risks and potentially other market risks, including those related to interest rates or valuation of financial instruments, among others.

Foreign Currency Exchange Risk

There was no material foreign currency risk for the three months ended March 31, 2022 and 2021, or years ended December 31, 2021 and 2020.

UNAUDITED PRO FORMA CONDENSED COMBINED AND CONSOLIDATED FINANCIAL INFORMATION

CLAQ is providing the following unaudited pro forma condensed combined and consolidated financial information to aid you in your analysis of the financial aspects of the Business Combination and related transactions. The following unaudited pro forma condensed combined and consolidated financial information presents the combination of the financial information of CLAQ and Nauticus adjusted to give effect to the Business Combination and related transactions. The following unaudited pro forma condensed combined and consolidated financial information has been prepared in accordance with Article 11 of Regulation S-X as amended by the final rule, Release No. 33-10786 “Amendments to Financial Disclosures about Acquired and Disposed Businesses.” Defined terms included below have the same meaning as terms defined and included elsewhere in this proxy statement/prospectus.

The historical financial information of CLAQ was derived from the unaudited condensed consolidated financial statements of CLAQ as of March 31, 2022 and for the three months ended March 31, 2022 and the audited consolidated financial statements of CLAQ as of December 31, 2021, included elsewhere in this proxy statement/prospectus. The historical financial information of Nauticus was derived from the unaudited condensed financial statements of Nauticus as of March 31, 2022 and for the three months ended March 31, 2022 and the audited consolidated financial statements of Nauticus as of December 31, 2021, included elsewhere in this proxy statement/prospectus. Such unaudited pro forma financial information has been prepared on a basis consistent with the audited financial statements of CLAQ and Nauticus, respectively, and should be read in conjunction with the audited historical financial statements and related notes, each of which is included elsewhere in this proxy statement/prospectus. This information should be read together with CLAQ’s and Nauticus’ audited financial statements and related notes, the sections titled “*Management’s Discussion and Analysis of Financial Condition and Results of Operations of CLAQ*” and “*Management’s Discussion and Analysis of Financial Condition and Results of Operations of Nauticus*” and other financial information included elsewhere in this proxy statement/prospectus.

The Business Combination is accounted for as a reverse recapitalization, with no goodwill or other intangible assets recorded, in accordance with GAAP. Under this method of accounting, CLAQ is treated as the “acquired” company for financial reporting purposes. Nauticus has been determined to be the accounting acquirer because Nauticus, as a group, will retain a majority of the outstanding shares of the combined company as of the closing of the Business Combination, they have nominated eight of the nine members of the board of directors as of the closing of the Business Combination, Nauticus’ management will continue to manage the combined company and Nauticus’ business will comprise the ongoing operations of the combined company.

The unaudited pro forma condensed combined balance sheet as of March 31, 2022 assumes that the Business Combination and related transactions occurred on March 31, 2022. The unaudited pro forma condensed combined and consolidated statement of operations for the three months ended March 31, 2022 gives pro forma effect to the Business Combination and related transactions as if they had occurred on January 1, 2021. CLAQ and Nauticus have not had any historical relationship prior to the Business Combination. Accordingly, no pro forma adjustments were required to eliminate activities between the companies.

These unaudited pro forma condensed combined and consolidated financial statements are for informational purposes only. They do not purport to indicate the results that would have been obtained had the Business Combination and related transactions actually been completed on the assumed date or for the periods presented, or which may be realized in the future. The pro forma adjustments are based on the information currently available and the assumptions and estimates underlying the pro forma adjustments are described in the accompanying notes. Actual results may differ materially from the assumptions within the accompanying unaudited pro forma condensed combined financial information.

Description of the Business Combination

On December 16, 2021, CleanTech Acquisition Corp., a Delaware corporation (“CleanTech” or “CLAQ”), entered into an Agreement and Plan of Merger (the “Merger Agreement,” and together with the other agreements and transactions contemplated by the Merger Agreement, the “Business Combination”) with CleanTech Merger Sub, Inc., a Delaware corporation and a wholly owned subsidiary of CleanTech (“Merger Sub”), and Nauticus Robotics, Inc., a Texas corporation (“Nauticus” or “Nauticus Robotics”). Pursuant to the terms of the Merger Agreement, a business combination between CLAQ and Nauticus will be effected through the merger of Merger Sub with and into Nauticus, with Nauticus surviving the merger as a wholly owned subsidiary of CLAQ (the “Merger”).

At the closing of the Business Combination, the total consideration received by Nauticus Equity Holders from CLAQ will have an aggregate value equal to \$300,000,000, payable, in the case of Nauticus Equity Holders, solely in new shares of Common Stock. The new shares of Common Stock will be deliverable to Nauticus Equity Holders and will be allocated

[Table of Contents](#)

pro rata after giving effect to the required conversion of all of the Nauticus securities into shares of Nauticus common stock immediately prior to, and contingent upon, the Closing. Based on the number of shares of Nauticus outstanding as of September 30, 2021 (together, solely for the purposes of this calculation, with additional Nauticus shares issued upon exercise of Nauticus Convertible Notes) on a fully-diluted and as-converted basis, taking into account the assumptions further described below, Nauticus Stockholders will receive an estimated 30,000,0000 shares of Common Stock.

Following the closing of the Business Combination, former holders of shares of Nauticus Common Stock (including shares received as a result of the Nauticus Preferred Stock Conversion and the Nauticus Contingently Convertible Notes Conversion) shall each be entitled to receive their pro rata share of up to 7,500,000 additional shares of CLAQ Common Stock (the “Earnout Shares”) if, within a 5-year period following the signing date of the Merger Agreement, the closing share price of the CLAQ Common Stock equals or exceeds any of three thresholds over any 20 trading days within a 30-day trading period (each, a “Triggering Event”).

- (i) one-half of the Escrow Shares will be released if, within a 5-year period following the signing date of the Merger Agreement, the volume-weighted average price of the Combined Company Common Stock equals or exceeds \$15.00 per share over any 20 trading days within a 30-day trading period;
- (ii) one-quarter of the Escrow Shares will be released if, within a 5-year period following the signing date of the Merger Agreement, the volume-weighted average price of the Combined Company Common Stock equals or exceeds \$17.50 per share over any 20 trading days within a 30-day trading period; and
- (iii) one-quarter of the Escrow Shares will be released if, within a 5-year period following the signing date of the Merger Agreement, the volume-weighted average price of the Combined Company Common Stock equals or exceeds \$20.00 per share over any 20 trading days within a 30-day trading period.

The accounting treatment of the Earnout Shares is expected to be recognized at fair value upon the closing of the Business Combination and classified in stockholders’ equity. Because the Business Combination is accounted for as a reverse recapitalization, the issuance of the Earnout Shares will be treated as a deemed dividend and since CLAQ will not have retained earnings, the issuance will be recorded within additional-paid-in-capital. The unaudited pro forma condensed combined financial information does not reflect pro forma adjustments related to the recognition of these shares because there is no net impact on additional paid-in capital on a pro forma combined basis. We expect to finalize our assessment of the accounting treatment prior to the Closing.

Subscription Agreements

In connection with the execution of the Merger Agreement, CLAQ entered into subscription agreements (collectively, the “Subscription Agreements”) with certain parties subscribing for shares of CLAQ Common Stock (the “Subscribers”) pursuant to which the Subscribers have agreed to purchase, and CLAQ has agreed to sell to the Subscribers, an aggregate of 3,530,000 shares of CLAQ Common Stock, for a purchase price of \$10.00 per share and an aggregate purchase price of \$35.3 million. The obligations to consummate the transactions contemplated by the Subscription Agreements are conditioned upon, among other things, customary closing conditions and the consummation of the transactions contemplated by the Merger Agreement.

Securities Purchase Agreement

Also, in connection with the execution of the Merger Agreement, CLAQ and Nauticus entered into Securities Purchase Agreement with certain investors purchasing up to an aggregate of \$40.0 million in principal amount of secured Debentures and warrants. The number of shares of common stock into which the Debentures are convertible is equal to 120% of the outstanding principal amount of the Debentures divided by the conversion price of \$15.00, and the number of shares of common stock into which the associated warrants are exercisable is equal to 120% of the outstanding principal amount of the Debentures divided by the conversion price, with an exercise price equal to \$20, subject to adjustment. The exercise price of the associated warrant will be subject to (i) customary anti-dilution adjustments; and (ii) in the case of a subsequent equity sale at a per share price below the exercise price, the exercise price of the associated warrant will be adjusted to such lower price, and the number of shares underlying the warrant will increase proportionately. In the event of a rights offering or dividend, the warrant holder will be treated as though the shares underlying the warrant he/she holds were outstanding. These warrants can be exercised on a cashless basis. There will be an original issue discount of 2% from the issued amount of the Debentures. Interest will accrue on all outstanding principal amount of the Debentures at 5% per annum, payable quarterly. The obligations to consummate the transactions contemplated by the Securities Purchase Agreement are conditioned upon, among other things, customary closing conditions and the consummation of the transactions contemplated by the Merger Agreement.

[Table of Contents](#)

The pro forma adjustments giving effect to the Business Combination and related transactions are summarized below, and are discussed further in the footnotes to these unaudited pro forma condensed combined and consolidated financial statements:

- the consummation of the Business Combination and reclassification of cash held in CLAQ' Trust Account to cash and cash equivalents, net of redemptions (see below);
- issuance of Common Stock pursuant to the Rights;
- the consummation of the Subscription Agreements;
- the consummation of the Debt Financing;
- the Bridge Loan (as defined in the Merger Agreement); and
- the accounting for certain offering costs and transaction costs incurred by both CLAQ and Nauticus.

The unaudited pro forma condensed combined and consolidated financial information has been prepared using the assumptions below with respect to the potential redemption into cash of shares of CLAQ ordinary shares:

- **Assuming No Redemptions:** This scenario assumes that no public stockholders of CLAQ exercise redemption rights with respect to their public shares for a pro rata share of the funds in the Trust Account.
- **Assuming Maximum Redemptions:** This scenario assumes that 17,250,000 CLAQ Common Stock subject to redemption are redeemed for an aggregate payment of approximately \$174.2 million (based on an estimated per share redemption price of approximately \$10.10 that was calculated using the \$174.2 million of cash in the Trust Account divided by 17,250,000 CLAQ shares of Common Stock subject to redemption assuming the pro forma maximum redemption scenario pursuant to the Merger Agreement). Under the terms of the Merger Agreement, the aggregate cash proceeds received from the Trust Account, together with the proceeds from the PIPE Investment and after the payment of transaction expenses, must equal no less than \$50.0 million. The Equity Financing will satisfy the closing condition related to the equity financing requirement for the Debt Financing and that the PIPE Investment alone will satisfy the Minimum Cash Condition under the Merger Agreement.

The following summarizes the pro forma ownership of common stock of CLAQ following the Business Combination and the PIPE Investment under both the no redemption and maximum redemption scenarios:

	Assuming Minimum Redemptions (Shares)	%	Assuming Maximum Redemptions (Shares)	%
Nauticus stockholders ⁽¹⁾	30,031,279	53.6%	30,031,279	77.6%
CLAQ public stockholders ⁽²⁾	18,112,500	32.4%	862,500	2.2%
Initial Stockholders ⁽³⁾	4,312,500	7.7%	4,312,500	11.1%
PIPE Investment investors	3,530,000	6.3%	3,530,000	9.1%
Pro forma Common Stock at March 31, 2022	55,986,279	100.0%	38,736,279	100.0%

- (1) Excludes 7,500,000 Earnout Shares of Common Stock as the earnout contingency has not yet been met. Such shares will be deposited into escrow and will be subject to reduction or forfeiture in accordance with the terms of the Merger Agreement. The Nauticus stockholders in whose names the Earnout Shares are issued at Closing will maintain voting rights related to such shares unless forfeited.
- (2) Excludes 8,625,000 Public Warrants and includes the issuance of 862,500 shares of Common Stock pursuant to the Rights.
- (3) Excludes 7,175,000 Private Warrants. The founder shares were placed into an escrow account maintained in New York, New York by Continental Stock Transfer & Trust Company, acting as escrow agent. Subject to certain limited exceptions, (i) 50% of the 4,312,500 founder shares will not be released from escrow until the earlier of (A) six (6) months after the closing of the Business Combination, or (B) the date on which the closing price of shares of common stock equals or exceeds \$12.50 per share for any 20 trading days within any 30-trading day period commencing after the Business Combination; and (ii) the remaining 50% of the founder shares will not be released from escrow until six (6) months after the closing of the Business Combination, or earlier, in either case, if, subsequent to the Business Combination, consummate a subsequent liquidation, merger, stock exchange or other similar transaction which results in all stockholders having the right to exchange their shares of common stock for cash, securities or other property.

**UNAUDITED PRO FORMA CONDENSED COMBINED AND CONSOLIDATED BALANCE SHEET
AS OF MARCH 31, 2022**

	Cleantech (Historical)	Nauticus (Historical)	Transaction Accounting Adjustments (Assuming No Redemptions)	Pro Forma Combined (Assuming No Redemptions)	Transaction Accounting Adjustments (Assuming Maximum Redemptions)	Pro Forma Combined (Assuming Maximum Redemptions)
ASSETS						
Current assets						
Cash and cash equivalents	\$ 296,381	\$ 15,077,379	\$ 174,247,973	A \$ 224,426,270	\$ (174,247,973)	J \$ 50,178,297
			72,500,000	B		
			(21,945,463)	C		
			(15,750,000)	I		
Restricted certificate of deposit	—	251,236	—	251,236	—	251,236
Accounts receivable, net of allowance	—	1,005,915	—	1,005,915	—	1,005,915
Inventory	—	721,042	—	721,042	—	721,042
Contract assets	—	592,759	—	592,759	—	592,759
Other current assets	44,991	729,880	—	774,871	—	774,871
Total current assets	341,372	18,378,211	209,052,510	227,772,093	(174,247,973)	53,524,120
Investments held in Trust Account	174,247,973	—	(174,247,973)	A	—	—
Property and equipment, net	—	3,001,230	—	3,001,230	—	3,001,230
Right-of-use asset – operating lease	—	481,438	—	481,438	—	481,438
Other assets	—	172,705	—	172,705	—	172,705
Total assets	<u>\$ 174,589,345</u>	<u>\$ 22,033,584</u>	<u>\$ 34,804,537</u>	<u>\$ 231,427,466</u>	<u>\$ (174,247,973)</u>	<u>\$ 57,179,493</u>
LIABILITIES, TEMPORARY EQUITY AND STOCKHOLDERS' EQUITY (DEFICIT)						
Current liabilities						
Accounts payable	\$ 178,311	\$ 1,657,452	\$ (50,000)	C \$ 1,785,763	\$ —	\$ 1,785,763
Accrued liabilities	9,000	1,384,026	(857,596)	E 535,430	—	535,430
Accrued liabilities – related party	83,333	—	—	83,333	—	83,333
Franchise tax payable	23,967	—	—	23,967	—	23,967
Promissory note – related party	267,000	—	(267,000)	C	—	—
Operating lease liabilities – current	—	399,274	—	399,274	—	399,274
Notes payable – current	—	10,250,000	(10,250,000)	E	—	—
Noted payable, related parties – current	—	3,000,000	(3,000,000)	E	—	—
Total current liabilities	561,611	16,690,752	(14,424,596)	2,827,767	—	2,827,767
Warrant liability	5,559,750	—	—	5,559,750	—	5,559,750
Notes payable – long-term	—	14,757,896	(14,757,896)	I	—	—
Convertible senior secured notes	—	—	21,044,251	B 21,044,251	—	21,044,251
Operating lease liabilities – long-term	—	356,989	—	356,989	—	356,989
Other liabilities	—	143,249	(20,833)	I 122,416	—	122,416
Total liabilities	6,121,361	31,948,886	(8,159,074)	29,911,173	—	29,911,173
Common stock subject to possible redemption	174,225,000	—	(174,225,000)	F	—	—
Stockholders' equity (deficit)						
Series A preferred stock	—	3,348	(3,348)	G	—	—
Series B preferred stock	—	7,254	(7,254)	G	—	—
Common stock	431	9,522	353	B 5,598	(1,725)	J 3,873
			86	D		
			530	E		

			1,725	F			
			(7,049)	G			
Treasury stock	—	(944,927)	944,927	G	—	—	—
Additional paid-in capital	—	34,358,034	51,455,396	B	253,133,366	(174,246,248)	J 78,887,118
			(13,468,000)	C			
			(86)	D			
			13,249,470	E			
			174,223,275	F			
			(927,276)	G			
			(5,757,447)	H			
Accumulated deficit	(5,757,447)	(43,348,533)	(8,160,463)	C	(51,622,671)	—	(51,622,671)
			857,596	E			
			5,757,447	H			
			(971,271)	I			
Total stockholders' equity (deficit)	<u>(5,757,016)</u>	<u>(9,915,302)</u>	<u>217,188,611</u>		<u>201,516,293</u>	<u>(174,247,973)</u>	<u>27,268,320</u>
Total liabilities, temporary equity, and stockholders' (deficit) equity	<u>\$ 174,589,345</u>	<u>\$ 22,033,584</u>	<u>\$ 34,804,537</u>		<u>\$ 231,427,466</u>	<u>\$ (174,247,973)</u>	<u>\$ 57,179,493</u>

**UNAUDITED PRO FORMA CONDENSED COMBINED AND
CONSOLIDATED STATEMENT OF OPERATIONS
FOR THE THREE MONTHS ENDED MARCH 31, 2022**

	Cleantech (Historical)	Nauticus (Historical)	Transaction Accounting Adjustments (Assuming No Redemptions)	Pro Forma Combined (Assuming No Redemptions)	Transaction Accounting Adjustments (Assuming Maximum Redemptions)	Pro Forma Combined (Assuming Maximum Redemptions)
Revenue						
Service	\$ —	\$ 2,235,965	\$ —	\$ 2,235,965	\$ —	\$ 2,235,965
	<u>—</u>	<u>2,235,965</u>	<u>—</u>	<u>2,235,965</u>	<u>—</u>	<u>2,235,965</u>
Costs and Expenses						
Cost of revenue (exclusive of items shown separately below)	—	1,899,161	—	1,899,161	—	1,899,161
Depreciation and amortization	—	111,319	—	111,319	—	111,319
Research and development	—	1,267,412	—	1,267,412	—	1,267,412
Operating costs	458,647	—	—	458,647	—	458,647
Franchise tax expense	20,728	—	—	20,728	—	20,728
General and administrative	—	1,646,041	—	1,646,041	—	1,646,041
Total operating costs	<u>479,375</u>	<u>4,923,933</u>	<u>—</u>	<u>5,403,308</u>	<u>—</u>	<u>5,403,308</u>
Operating loss	(479,375)	(2,687,968)	—	(3,167,343)	—	(3,167,343)
Other expense (income)						
Net gain on investments held in Trust Account	(17,545)	—	17,545	AA —	—	—
Change in fair value of warrant liabilities	(2,413,500)	—	—	(2,413,500)	—	(2,413,500)
Other (income) expense, net	—	14,060	—	14,060	—	14,060
Interest expense, net	—	801,974	(838,811)	CC 1,286,342	—	1,286,342
			1,323,179	DD		
Total other (income) expense, net	<u>(2,431,045)</u>	<u>816,034</u>	<u>501,913</u>	<u>(1,113,098)</u>	<u>—</u>	<u>(1,113,098)</u>
Net income (loss)	<u>\$ 1,951,670</u>	<u>\$ (3,504,002)</u>	<u>\$ (501,913)</u>	<u>\$ (2,054,245)</u>	<u>\$ —</u>	<u>\$ (2,054,245)</u>
Net income (loss) per share (Note 4)						
Weighted average shares outstanding	<u>21,562,500</u>	<u>680,600</u>		<u>55,986,279</u>		<u>38,736,279</u>
Basic and diluted net income (loss) per share	<u>\$ 0.09</u>	<u>\$ (5.15)</u>		<u>\$ (0.04)</u>		<u>\$ (0.05)</u>

**UNAUDITED PRO FORMA CONDENSED COMBINED AND
CONSOLIDATED STATEMENT OF OPERATIONS
FOR THE YEAR ENDED DECEMBER 31, 2021**

	Cleantech (Historical)	Nauticus (Historical)	Transaction Accounting Adjustments (Assuming No Redemptions)	Pro Forma Combined (Assuming No Redemptions)	Transaction Accounting Adjustments (Assuming Maximum Redemptions)	Pro Forma Combined (Assuming Maximum Redemptions)
Revenue						
Service	\$ —	\$ 7,854,068	\$ —	\$ 7,854,068	\$ —	\$ 7,854,068
Product	—	242,637	—	242,637	—	242,637
Service – related party	—	332,767	—	332,767	—	332,767
Product – related party	—	162,068	—	162,068	—	162,068
	—	8,591,540	—	8,591,540	—	8,591,540
Costs and Expenses						
Cost of revenue (exclusive of items shown separately below)	—	6,850,248	—	6,850,248	—	6,850,248
Depreciation and amortization	—	365,097	—	365,097	—	365,097
Research and development	—	3,533,713	—	3,533,713	—	3,533,713
Operating and formation costs	1,201,383	—	—	1,201,383	—	1,201,383
Franchise tax expense	97,200	—	—	97,200	—	97,200
General and administrative	—	4,362,400	8,160,463	BB 12,522,863	—	12,522,863
Total operating costs	1,298,583	15,111,458	8,160,463	24,570,504	—	24,570,504
Operating loss	(1,298,583)	(6,519,918)	(8,160,463)	(15,978,964)	—	(15,978,964)
Other expense (income)						
Transaction costs	155,037	—	—	155,037	—	155,037
Net gain on investments held in Trust Account	(5,428)	—	5,428	AA —	—	—
Change in fair value of warrant liabilities	(1,077,750)	—	—	(1,077,750)	—	(1,077,750)
Change in fair value of over-allotment option liability	225,000	—	—	225,000	—	225,000
Other income	—	(1,601,568)	—	(1,601,568)	—	(1,601,568)
Loss on extinguishment of debt	—	9,484,113	—	9,484,113	—	9,484,113
Interest expense (income), net	—	725,166	(703,933)	CC 4,890,845	—	4,890,845
			4,869,612	DD		
Total other (income)	(703,141)	8,607,711	4,171,107	12,075,677	—	12,075,677
Net income (loss)	\$ (595,442)	\$ (15,127,629)	\$ (12,331,570)	\$ (28,054,641)	\$ —	\$ (28,054,641)
Net income (loss) per share (Note 4)						
Weighted average shares outstanding	11,781,678	678,406		55,986,279		38,736,279
Basic and diluted net income (loss) per share	\$ (0.05)	\$ (22.30)		\$ (0.50)		\$ (0.72)

**NOTES TO UNAUDITED PRO FORMA CONDENSED COMBINED AND
CONSOLIDATED FINANCIAL INFORMATION**

Note 1. Basis of Presentation

The Business Combination will be accounted for as a reverse recapitalization, with no goodwill or other intangible assets recorded, in accordance with GAAP. Under this method of accounting, CLAQ will be treated as the “accounting acquiree” and Nauticus as the “accounting acquirer” for financial reporting purposes. Accordingly, for accounting purposes, the Business Combination will be treated as the equivalent of Nauticus issuing shares for the net assets of CLAQ, followed by a recapitalization. The net assets of CLAQ will be stated at historical cost. Operations prior to the Business Combination will be those of Nauticus.

The unaudited pro forma condensed combined and consolidated balance sheet as of March 31, 2022 gives effect to the Business Combination and related transactions as if they occurred on March 31, 2022. The unaudited pro forma condensed combined and consolidated statement of operations for the three months ended March 31, 2022 gives effect to the Business Combination and related transactions as if they occurred January 1, 2021, the beginning of the earliest period presented. These periods are presented on the basis that Nauticus is the acquirer for accounting purposes.

The pro forma adjustments reflecting the consummation of the Business Combination and the related transaction are based on certain currently available information and certain assumptions and methodologies that CLAQ management believes are reasonable under the circumstances. The unaudited condensed combined and consolidated pro forma adjustments, which are described in the accompanying notes, may be revised as additional information becomes available and is evaluated. Therefore, it is likely that the actual adjustments will differ from the pro forma adjustments, and it is possible that the difference may be material. CLAQ management believes that its assumptions and methodologies provide a reasonable basis for presenting all of the significant effects of the Business Combination and the related transactions based on information available to management at this time and that the pro forma adjustments give appropriate effect to those assumptions and are properly applied in the unaudited pro forma condensed combined financial information.

The unaudited pro forma condensed combined and consolidated financial information does not give effect to any anticipated synergies, operating efficiencies, tax savings, or cost savings that may be associated with the Business Combination. The unaudited pro forma condensed combined and consolidated financial information is not necessarily indicative of what the actual results of operations and financial position would have been had the Business Combination and related transactions taken place on the dates indicated, nor are they indicative of the future consolidated results of operations or financial position of the post-combination company. They should be read in conjunction with the historical financial statements and notes thereto of CLAQ and Nauticus.

Note 2. Accounting Policies and Reclassifications

Upon consummation of the Business Combination, management will perform a comprehensive review of the two entities’ accounting policies. As a result of the review, management may identify differences between the accounting policies of the two entities which, when conformed, could have a material impact on the financial statements of the post-combination company. Based on its initial analysis, management did not identify any differences that would have a material impact on the unaudited pro forma condensed combined and consolidated financial information. As a result, the unaudited pro forma condensed combined and consolidated financial information does not assume any differences in accounting policies.

As part of the preparation of these unaudited pro forma condensed combined and consolidated financial statements, certain reclassifications were made to align CLAQ’s financial statement presentation with that of Nauticus.

Note 3. Adjustments to Unaudited Pro Forma Condensed Combined and Consolidated Financial Information

The unaudited pro forma condensed combined and consolidated financial information has been prepared to illustrate the effect of the Business Combination and related transactions and has been prepared for informational purposes only.

[Table of Contents](#)

The following unaudited pro forma condensed combined and consolidated financial information has been prepared in accordance with Article 11 of Regulation S-X as amended by the final rule, Release No. 33-10786 “Amendments to Financial Disclosures about Acquired and Disposed Businesses.” Release No. 33-10786 replaces the existing pro forma adjustment criteria with simplified requirements to depict the accounting for the transaction (“Transaction Accounting Adjustments”) and present the reasonably estimable synergies and other transaction effects that have occurred or are reasonably expected to occur (“Management’s Adjustments”). CLAQ has elected not to present Management’s Adjustments and will only be presenting Transaction Accounting Adjustments in the unaudited pro forma condensed combined and consolidated financial information. CLAQ and Nauticus have not had any historical relationship prior to the Business Combination. Accordingly, no pro forma adjustments were required to eliminate activities between the companies.

The pro forma basic and diluted earnings per share amounts presented in the unaudited pro forma condensed combined and consolidated statement of operations are based upon the number of Nauticus’ ordinary shares outstanding, assuming the Business Combination and related transactions occurred on January 1, 2021.

Adjustments to Unaudited Pro Forma Condensed Combined Balance Sheet

The adjustments included in the unaudited pro forma condensed combined balance sheet as of March 31, 2022 are as follows:

- A. Reflects the reclassification of \$174.2 million held in the Trust Account to cash and cash equivalents that becomes available at closing of the Business Combination, assuming no redemptions.
- B. Represents cash proceeds of \$72.5 million pursuant to the PIPE Investment. Pursuant to the PIPE Investment an aggregate of 3,530,000 shares of CLAQ Common Stock is issued at a purchase price of \$10.00 per share and an aggregate purchase price of \$35.3 million and corresponding offset to additional-paid-in-capital; in addition the issuance an aggregate of \$38.0 million in principal amount of secured debentures and 3,036,795 Warrants for proceeds of \$37.2 million. There will be an original issue discount of 2% from the issued amount of the debentures. Interest will accrue on all outstanding principal amount of the debentures at 5% per annum, payable quarterly. The Company determined that the Warrants will be equity-classified. For purposes of the unaudited pro forma condensed combined balance sheet, the estimated fair value of the Warrants, \$16.2 million will be recorded as a debt discount with an offset to additional-paid-in capital. The fair value of the Warrants was based on a Monte Carlo simulation with key inputs and assumptions such as stock price, term, dividend yield, risk-free rate, and volatility.
- C. Represents estimated transaction costs and the repayment of the CLAQ related party promissory note. Of the estimated transaction costs \$0.3 million has already been incurred and reflected in the historical financial statements of CLAQ. This adjustment reflects the settlement of estimated remaining transaction costs to be incurred as part of the Business Combination, including \$0.1 million within accounts payable of CLAQ. Estimated transaction costs is comprised of equity issuance costs of \$13.5 million that was offset to additional-paid-in-capital, primarily consisting of \$7.6 million pursuant to an amended and restated financial advisory agreement with Coastal, \$2.1 million pursuant to a Financial Advisory Agreement with Chardan, representing 6.0% of the gross proceeds received from the PIPE Investment, \$2.0 million in estimated legal costs estimated to be incurred by Nauticus that directly result from the Business Combination and \$1.8 million pursuant to a letter agreement dated March 23, 2022 with Cowen, in which Nauticus has agreed to pay Cowen an advisory fee upon closing of the Business Combination. Approximately \$8.2 million estimated to be incurred by CLAQ was expensed as part of the Business Combination and recorded in accumulated deficit. This includes \$6.0 million pursuant to a Business Combination Marketing Agreement with Chardan, \$1.0 million in legal costs estimated to be incurred by CLAQ and \$0.7 million pursuant to letter agreements with Roth and Lake Street, and approximately \$0.6 million of miscellaneous and estimated printing and accounting services.
- D. Reflects the issuance of 862,500 shares of Common Stock pursuant to the 17,250,000 outstanding Rights. Each Right represents the right to receive one-twentieth (1/20) of one share of Common Stock upon the consummation of the Business Combination and related transactions.

Table of Contents

- E. Represents the conversion of the outstanding principal and related accrued interest of the Nauticus Convertible Notes into shares of Nauticus Common Stock, in contemplation of the Business Combination and related transactions. Nauticus Common Stock is a component of Nauticus equity interests converted into shares of Common Stock pursuant to the Merger Agreement.
- F. Reflects the reclassification of approximately \$174.2 million of Common Stock subject to possible redemption to permanent equity.
- G. Represents recapitalization of Nauticus' outstanding equity as a result of the reverse recapitalization and the issuance of Common Stock to Nauticus Equity Holders as consideration for the reverse recapitalization.
- H. Reflects the reclassification of CLAQ' historical accumulated deficit into additional paid-in capital as part of the reverse recapitalization.
- I. Reflects the payment of the Term Loan Credit Agreement (the "Bridge Loan" as defined in the Merger Agreement) by and among Nauticus and RCB Equities #1, LLC dated December 16, 2021, as well as the elimination of accrued interest and associated debt discount. The Bridge Loan principal amount is \$15.0 million. Nauticus agreed to pay the lender a commitment fee equal to 2.0% of the principal amount as well as an exit fee of 5% of amounts due upon payment. The Bridge Loan and exit fee is mandatorily payable upon closing of the Business Combination.
- J. Reflects a scenario in which 17,250,000 Public Shares are redeemed in connection with the Business Combination, for aggregate payments to redeeming Public Shareholders of \$174.2 million (assuming a redemption price of \$10.10 per share), allocated to Common Stock and additional paid-in capital using par value \$0.0001 per share. This adjustment is recorded after consideration that under the terms of the Merger Agreement, the aggregate cash proceeds received from the Trust Account, together with the proceeds from the Subscription Agreements and after the payment of transaction expenses, must equal no less than \$50.0 million.

Adjustments to Unaudited Pro Forma Condensed Combined and Consolidated Statements of Operations

The pro forma adjustments included in the unaudited pro forma condensed combined and consolidated statement of operations for the three months ended March 31, 2022 are as follows:

- AA. Reflects elimination of investment income on the Trust Account.
- BB. Reflects the estimated transaction costs of approximate \$8.2 million as if incurred on January 1, 2021, the date the Business Combination occurred for the purposes of the unaudited pro forma condensed combined statement of operations. This is a non-recurring item.
- CC. Represents the elimination of the interest expense related to the conversion of the outstanding principal and related accrued interest of the Nauticus Convertible Notes into shares of Nauticus Common Stock, in contemplation of the Business Combination and related transaction as if they had occurred on January 1, 2021.
- DD. To reflect an adjustment to recognize interest expense and amortization of the debt discount associated with the original issue discount and Warrant pursuant to the secured debentures issued pursuant to the PIPE Investment as it is assumed that they would have been outstanding as if the Business Combination and related transactions had occurred on January 1, 2021 and interest being accrued on all outstanding principal amount of the debentures at 5% per annum.

Note 4. Net Income (Loss) per Share

Net income (loss) per share was calculated using the historical weighted average shares outstanding, and the issuance of additional shares in connection with the Business Combination and the related transactions, assuming the shares were outstanding since January 1, 2021. As the Business Combination and the related transactions are being reflected as if they had occurred at the beginning of the period presented, the calculation of weighted average shares outstanding for basic and diluted net income (loss) per share assumes that the shares issuable relating to the Business Combination and related have been outstanding for the entirety of all periods presented.

The unaudited pro forma condensed combined and consolidated financial information has been prepared to present two alternative scenarios with respect to redemption of Common Stock by CLAQ Public Stockholders at the time of the Business Combination for the three months ended March 31, 2022 and the year ended December 31, 2022:

	Three Months Ended March 31, 2022 ⁽¹⁾		Year Ended December 31, 2021 ⁽¹⁾	
	Assuming No Redemptions	Assuming Maximum Redemptions	Assuming No Redemptions	Assuming Maximum Redemptions
Pro forma net loss	\$ (2,054,245)	\$ (2,054,245)	\$ (28,054,641)	\$ (28,054,641)
Weighted average shares outstanding – basic and diluted	55,986,279	38,736,279	55,986,279	38,736,279
Net loss per share – basic and diluted	\$ (0.04)	\$ (0.05)	\$ (0.50)	\$ (0.72)
<i>Excluded securities:⁽²⁾</i>				
Public Warrants	8,625,000	8,625,000	8,625,000	8,625,000
Private Warrants	7,175,000	7,175,000	7,175,000	7,175,000
Earnout Shares	7,500,000	7,500,000	7,500,000	7,500,000
Nauticus Options	3,977,368	3,977,368	3,977,368	3,977,368
Debentures	3,036,735	3,036,735	3,036,735	3,036,735
Warrants	3,036,735	3,036,735	3,036,735	3,036,735

(1) Pro forma income (loss) per share includes the related pro forma adjustments as referred to within the section “Unaudited Pro Forma Condensed Combined Financial Information.”

(2) The potentially dilutive outstanding securities were excluded from the computation of pro forma net loss per share, basic and diluted, because their effect would have been anti-dilutive, issuance or vesting of such shares is contingent upon the satisfaction of certain conditions which were not satisfied by the end of the periods presented.

DESCRIPTION OF CLAQ'S SECURITIES

General

Pursuant to our current Certificate of Incorporation, our authorized stock consists of 30,000,000 shares of common stock, par value \$0.0001, and 1,000,000 shares of preferred stock, par value \$0.0001. As of the date of this proxy statement/prospectus, 21,562,500 shares of common stock are issued and outstanding. No preferred shares are issued or outstanding. The following description summarizes the material terms of our securities. Because it is only a summary, it may not contain all the information that is important to you. For a complete description you should refer to our Certificate of Incorporation, bylaws, our warrant agreement, and to the applicable provisions of Delaware law.

Units

Each unit consists of one share of common stock, one right and one-half of one warrant. Each right entitles the holder to receive one-twentieth (1/20) of a share of common stock. We do not issue fractional securities. As a result, you must have 20 rights to receive a share of common stock and 2 units to receive a share of common stock when exercising your warrants. Each whole Warrant entitles the holder thereof to purchase one share of common stock at a price of \$11.50 per whole share. Pursuant to the warrant agreement, a warrant holder may exercise its Warrants only for a whole number of shares of common stock. This means that only a whole Warrant may be exercised at any given time by a warrant holder. No fractional warrants are issued upon separation of the Units or Common Stock and only whole Warrants trade.

Each private warrant entitles the holder thereof to purchase one share of common stock. Each warrant will become exercisable on the later of one year after the closing of this offering or the consummation of an initial business combination, and will expire five years after the completion of an initial business combination, or earlier upon redemption. The private warrants purchased by CleanTech Investments will not be exercisable more than five years from the IPO, as long as Chardan Capital Markets, LLC or any of its related persons beneficially own these private warrants.

Common Stock

Our stockholders of record are entitled to one vote for each share held on all matters to be voted on by stockholders. In connection with any vote held to approve our initial business combination, our Co-Sponsors, as well as all of our officers and directors, have agreed to vote their respective shares of common stock held by them in favor of the proposed Business Combination.

We will consummate our initial business combination only if we have net tangible assets of at least \$5,000,001 either immediately prior to or upon such consummation and, solely if a vote is held to approve a business combination, a majority of the outstanding shares of common stock voted are voted in favor of the business combination.

Pursuant to our certificate of incorporation, if we do not consummate our initial business combination within 12 months (or up to 18 months, as applicable) from our IPO, we will (i) cease all operations except for the purpose of winding up, (ii) as promptly as reasonably possible but not more than ten business days thereafter, redeem 100% of the outstanding public shares, which redemption will completely extinguish public stockholders' rights as stockholders (including the right to receive further liquidation distributions, if any), subject to applicable law, and (iii) as promptly as reasonably possible following such redemption, subject to the approval of our remaining stockholders and our board of directors, dissolve and liquidate, subject (in the case of (ii) and (iii) above) to our obligations under Delaware law to provide for claims of creditors and the requirements of other applicable law. Our insiders have agreed to waive their rights to share in any distribution with respect to their founder shares. However, if we anticipate that we may not be able to consummate our initial business combination within 12 months, our initial stockholders or their affiliates may, but are not obligated to, extend the period of time to consummate an initial business combination 2 times by an additional three months each time (for a total of up to 18 months to complete an initial business combination) without the need for a separate stockholder vote. Pursuant to the terms of our amended and restated certificate of incorporation and the trust agreement to be entered into between us and Continental Stock Transfer & Trust Company on the date of this prospectus, the only way to extend the time available for us to consummate our initial business combination without the need for a separate stockholder vote is for our initial stockholders or their affiliates or designees, upon five days' advance notice prior to the applicable deadline, to deposit into the trust account \$1,725,000 (\$0.10 per public share), or an aggregate of \$3,450,000 (if extended for each of the full three months), on or prior to the date of the applicable

deadline. Pursuant to our amended and restated certificate of incorporation and the trust agreement, if such funds are not deposited, the time to complete an initial business combination cannot be extended unless our stockholders otherwise approve an extension on different terms. In the event that they elected to extend the time to complete our initial business combination and deposited the applicable amount of money into trust, the initial stockholders would receive a non-interest bearing, unsecured promissory note equal to the amount of any such deposit that will not be repaid in the event that we are unable to close a business combination unless there are funds available outside the trust account to do so. Such note would be paid upon consummation of our initial business combination. In the event that we receive notice from our insiders five days prior to the applicable deadline of their intent to effect an extension, we intend to issue a press release announcing such intention at least three days prior to the applicable deadline.

Our stockholders have no conversion, preemptive or other subscription rights and there are no sinking fund or redemption provisions applicable to the shares of common stock, except that public stockholders have the right to sell their shares to us in any tender offer or have their shares of common stock converted to cash equal to their pro rata share of the trust account if they vote on the proposed business combination and the business combination is completed. In order for a public stockholder to have his, her or its shares redeemed for cash in connection with any proposed business combination, we may require that the public stockholders vote either in favor of or against a proposed business combination. If required to vote pursuant to the procedures specified in our proxy statement to stockholders relating to the business combination, and a public stockholder fails to vote in favor of or against the proposed business combination, whether that stockholder abstains from the vote or simply does not vote, that stockholder would not be able to have his, her or its shares of common stock redeemed to cash in connection with such business combination.

Preferred Stock

There are no shares of preferred stock outstanding. Our Certificate of Incorporation as of the date of this proxy statement/prospectus authorizes the issuance of 1,000,000 shares of preferred stock with such designation, rights and preferences as may be determined from time to time by the Board. Accordingly, the Board is empowered, without stockholder approval, to issue preferred stock with dividend, liquidation, conversion, voting or other rights which could adversely affect the voting power or other rights of the holders of common stock. However, the underwriting agreement prohibits us, prior to a business combination, from issuing preferred stock which participates in any manner in the proceeds of the Trust Account, or which votes as a class with the common stock on a business combination. We may issue some or all of the preferred stock to effect a business combination. In addition, the preferred stock could be utilized as a method of discouraging, delaying or preventing a change in control of us. Although we do not currently intend to issue any shares of preferred stock, we cannot assure you that we will not do so in the future.

Warrants

As of the date of this proxy statement/prospectus, 7,125,000 Warrants are outstanding. Each whole Warrant entitles the registered holder to purchase one share of common stock at a price of \$11.50 per share, subject to adjustment as discussed below, at any time commencing on the later of July 19, 2022 (or January 19, 2023, if extended) or after the completion of an initial business combination. However, no Warrants will be exercisable for cash unless we have an effective and current registration statement covering the shares of common stock issuable upon exercise of the Warrants and a current prospectus relating to such shares of common stock. Notwithstanding the foregoing, if a registration statement covering the shares of common stock issuable upon exercise of the public Warrants is not effective within 120 days following the consummation of our initial business combination, warrant holders may, until such time as there is an effective registration statement and during any period when we shall have failed to maintain an effective registration statement, exercise Warrants on a cashless basis pursuant to an available exemption from exemption under the Securities Act. The Warrants will expire on the fifth anniversary of our completion of an initial business combination, at 5:00 p.m., New York City time, or earlier upon redemption or liquidation.

The private Warrants, as well as any Warrants underlying additional Units we issue to our Sponsor, officers, directors or their affiliates in payment of working capital loans made to us, will be identical to the Warrants underlying the public Units except that (i) each private warrant is exercisable for one share of common stock at an exercise price of \$11.50 per share, and (ii) such private warrants will be exercisable for cash (even if a registration statement covering the shares of common stock issuable upon exercise of such warrants is not effective) or on a cashless basis, at the holder's option, and will not be redeemable by us, in each case so long as they are still held by the initial purchasers or

[Table of Contents](#)

their affiliates. The private warrants purchased by CleanTech Investments will not be exercisable more than five years from July 14, 2021, in accordance with FINRA Rule 5110(g)(8), as long as Chardan Capital Markets, LLC or any of its related persons beneficially own these private warrants.

We may call the outstanding warrants for redemption (excluding the private warrants but including any warrants already issued upon exercise of the unit purchase option), in whole and not in part, at a price of \$0.01 per warrant:

- at any time after the Warrants become exercisable,
- upon not less than 30 days' prior written notice of redemption to each warrant holder,
- if, and only if, the reported last sale price of the shares of common stock equals or exceeds \$16.50 per share (subject to adjustment for splits, dividends, recapitalizations and other similar events), for any 20 trading days within a 30-day trading period ending on the third business day prior to the notice of redemption to warrant holders, and
- if, and only if, there is a current registration statement in effect with respect to the shares of common stock underlying such warrants at the time of redemption and for the entire 30-day trading period referred to above and continuing each day thereafter until the date of redemption.

The right to exercise will be forfeited unless the warrants are exercised prior to the date specified in the notice of redemption. On and after the redemption date, a record holder of a warrant will have no further rights except to receive the redemption price for such holder's warrant upon surrender of such warrant.

The redemption criteria for our warrants have been established at a price which is intended to provide warrant holders a reasonable premium to the initial exercise price and provide a sufficient differential between the then-prevailing share price and the warrant exercise price so that if the share price declines as a result of our redemption call, the redemption will not cause the share price to drop below the exercise price of the warrants, however, such redemption may occur at a time when the redeemable warrants are "out-of-the-money," in which case you would lose any potential embedded value from a subsequent increase in the value of CLAQ Common Stock had your warrants remained outstanding. Historical trading prices for our CLAQ Common Stock have not exceeded the \$16.50 per share threshold at which the Public Warrants would become redeemable. However, this could occur in connection with or after the closing of the Business Combination.

In the event we determined to redeem our Public Warrants, holders of redeemable Public Warrants will be notified of such redemption as described in our warrant agreement between Continental Stock Transfer & Trust Company, as warrant agent, and us, dated July 14, 2021 (the "Warrant Agreement"). Specifically, in the event that we elect to redeem all of the redeemable Warrants as described above, we will fix a date for the redemption (the "Redemption Date"). Notice of redemption will be mailed by first class mail, postage prepaid, by us not less than 30 days prior to the Redemption Date to the registered holders of the redeemable Warrants to be redeemed at their last addresses as they appear on the Warrant Register. Any notice mailed in the manner provided in the Warrant Agreement will be conclusively presumed to have been duly given whether or not the registered holder received such notice. In addition, beneficial owners of the redeemable Warrants will be notified of such redemption via posting of the redemption notice to DTC.

If we call the warrants for redemption as described above, our management will have the option to require all holders that wish to exercise warrants to do so on a "cashless basis." In such event, each holder would pay the exercise price by surrendering the warrants for that number of shares of common stock equal to the quotient obtained by dividing (x) the product of the number of shares of common stock underlying the warrants, multiplied by the difference between the exercise price of the warrants and the "fair market value" by (y) the fair market value. The "fair market value" shall mean the average reported last sale price of our common stock for the 10 trading days ending on the third trading day prior to the date on which the notice of redemption is sent to the holders of warrants. Whether we will exercise our option to require all holders to exercise their warrants on a "cashless basis" will depend on a variety of factors including the price of our common shares at the time the warrants are called for redemption, our cash needs at such time and concerns regarding dilutive share issuances.

If our management takes advantage of this option, the notice of redemption will contain the information necessary to calculate the number of CLAQ Common Stock to be received upon exercise of the warrants, including the "fair market value" in such case. Requiring a cashless exercise in this manner will reduce the number of CLAQ Common Stock to be issued and thereby lessen the dilutive effect of a warrant redemption.

[Table of Contents](#)

We believe this feature is an attractive option to us if we do not need the cash from the exercise of the warrants after our initial business combination. If we call our warrants for redemption and our management does not take advantage of this option, the holders of the Private Warrants and their permitted transferees would still be entitled to exercise their Private Warrants for cash or on a cashless basis using the same formula described above that other warrant holders would have been required to use had all warrant holders been required to exercise their warrants on a cashless basis.

The Warrants were issued in registered form under the Warrant Agreement which provides that the terms of the Warrants may be amended without the consent of any holder to cure any ambiguity or correct any defective provision, but requires the approval, by written consent or vote, of the holders of the holders of a majority of the then outstanding warrants in order to make any change that adversely affects the interests of the registered holders.

The exercise price and number of shares of common stock issuable on exercise of the warrants may be adjusted in certain circumstances including in the event of a share dividend, extraordinary dividend or our recapitalization, reorganization, merger or consolidation. In addition, if we issue additional shares of common stock or equity-linked securities for capital raising purposes in connection with the closing of our initial business combination at a newly issued price of less than \$9.20 per share of common stock (with such issue price or effective issue price to be determined in good faith by our board of directors and, in the case of any such issuance to our initial stockholders or their affiliates, without taking into account any founder shares or private warrants held by them, as applicable, prior to such issuance), the exercise price of the warrants will be adjusted (to the nearest cent) to be equal to 115% of the newly issued price and the \$16.50 per share redemption trigger price described below under will be adjusted (to the nearest cent) to be equal to 165% of the market value (the volume weighted average trading price of the common stock during the 20 trading day period starting on the trading day prior to the consummation of an initial business combination).

The warrants may be exercised upon surrender of the warrant certificate on or prior to the expiration date at the offices of the warrant agent, with the exercise form on the reverse side of the warrant certificate completed and executed as indicated, accompanied by full payment of the exercise price, by certified or official bank check payable to us, for the number of warrants being exercised. The warrant holders do not have the rights or privileges of holders of shares of common stock and any voting rights until they exercise their warrants and receive shares of common stock. After the issuance of shares of common stock upon exercise of the warrants, each holder will be entitled to one vote for each share held of record on all matters to be voted on by stockholders.

Except as described above, no public warrants will be exercisable for cash, and we will not be obligated to issue shares of common stock unless at the time a holder seeks to exercise such warrant, a prospectus relating to the shares of common stock issuable upon exercise of the warrants is current and the shares of common stock have been registered or qualified or deemed to be exempt under the securities laws of the state of residence of the holder of the warrants. Under the terms of the warrant agreement, we have agreed to use our best efforts to meet these conditions and to maintain a current prospectus relating to the shares of common stock issuable upon exercise of the warrants until the expiration of the warrants. However, we cannot assure you that we will be able to do so and, if we do not maintain a current prospectus relating to the shares of common stock issuable upon exercise of the warrants, holders will be unable to exercise their warrants, and we will not be required to settle any such warrant exercise. If the prospectus relating to the shares of common stock issuable upon the exercise of the warrants is not current or if the common stock is not qualified or exempt from qualification in the jurisdictions in which the holders of the warrants reside, we will not be required to net cash settle or cash settle the warrant exercise, the warrants may have no value, the market for the warrants may be limited, and the warrants may expire worthless.

A holder of a warrant may notify us in writing in the event it elects to be subject to a requirement that such holder will not have the right to exercise such warrant, to the extent that after giving effect to such exercise, such person (together with such person's affiliates), to the warrant agent's actual knowledge, would beneficially own in excess of 4.99% or 9.99% (or such other amount as a holder may specify) of common stock outstanding.

No fractional shares will be issued upon exercise of the warrants. If, upon exercise of the warrants, a holder would be entitled to receive a fractional interest in a share, we will, upon exercise, round down to the nearest whole number the number of shares of common stock to be issued to the warrant holder.

We have agreed that, subject to applicable law, any action, proceeding or claim against us arising out of or relating in any way to the warrant agreement will be brought and enforced in the courts of the State of New York or the United States District Court for the Southern District of New York, and we irrevocably submit to such jurisdiction,

which jurisdiction will be the exclusive forum for any such action, proceeding or claim. See “Risk Factors — Our warrant agreement has designated the courts of the State of New York or the United States District Court for the Southern District of New York as the sole and exclusive forum for certain types of actions and proceedings that may be initiated by holders of our warrants, which could limit the ability of warrant holders to obtain a favorable judicial forum for disputes with our company.” This provision applies to claims under the Securities Act but does not apply to claims under the Exchange Act or any claim for which the federal district courts of the United States of America are the sole and exclusive forum.

Contractual Arrangements with respect to the Certain Warrants

We have agreed that so long as the private warrants are still held by the initial purchasers or their affiliates, we will not redeem such warrants, and we will allow the holders to exercise such warrants on a cashless basis. However, once any of the foregoing warrants are transferred from the initial purchasers or their affiliates, these arrangements will no longer apply. Furthermore, because the private warrants were issued in a private transaction, the holders and their transferees are allowed to exercise the private warrants for cash even if a registration statement covering the shares of common stock issuable upon exercise of such warrants is not effective and receive unregistered shares of common stock.

Rights

In connection with CLAQ’s IPO, 17,50,000 Rights were issued as part of the Units sold. Each right represents the right to receive one-twentieth (1/20) of one share of common stock upon the consummation of our initial business combination, so each holder of 20 rights will receive one share of common stock upon consummation of our initial business combination, whether or not we will be the surviving entity and even if the holder of such right redeemed all common stock held by him, her or it in connection with the initial business combination or an amendment to our amended and restated certificate of incorporation with respect to our pre-business combination activities. No fractional shares will be issued upon conversion of any rights, so holders must hold rights in denominations of 20 in order to receive a share of our common stock at the closing of our initial business combination. No additional consideration will be required to be paid by a holder of rights in order to receive his, her or its additional common stock upon consummation of an initial business combination. The shares issuable upon exchange of the rights will be freely tradable (except to the extent held by affiliates of ours). At the closing of the Business Combination, an aggregate of 862,500 of common stock will be issued as a result of the outstanding Rights.

As soon as practicable upon the occurrence of our initial business combination, we will direct holders of the rights to return their rights certificates to Continental Stock Transfer & Trust Company, in its capacity as rights agent. Upon receipt of the rights certificate, in a business combination in which we will be the surviving entity, we will issue to the registered holder of such rights the number of full shares of our common stock to which the holder is entitled.

If we enter into a definitive agreement for a business combination in which we will not be the surviving entity, the definitive agreement will provide for the holders of rights to receive the same per share consideration the holders of the common stock will receive in the transaction on an as-converted into common stock basis, and each holder of a right will be required to affirmatively convert his, her or its rights in order to receive the one-twentieth (1/20) share underlying each right (without paying any additional consideration) upon consummation of the business combination. More specifically, the right holder will be required to indicate his, her or its election to convert the rights into underlying shares as well as to return the original rights certificates to us.

If we are unable to complete an initial business combination within the required time period and we liquidate the funds held in the trust account, holders of rights will not receive any of such funds with respect to their rights, nor will they receive any distribution from our assets held outside of the trust account with respect to such rights, and the rights will expire worthless.

Promptly upon the consummation of our initial business combination, we will direct registered holders of the rights to return their rights to our rights agent. Upon receipt of the rights, the rights agent will issue to the registered holder of such right(s) the number of full shares of common stock to which he, she or it is entitled. We will notify registered holders of the rights to deliver their rights to the rights agent promptly upon consummation of such business combination and have been informed by the rights agent that the process of exchanging their rights for common stock should take no more than a matter of days. The foregoing exchange of rights is solely ministerial in nature and is not intended to provide us with any means of avoiding our obligation to issue the shares underlying the rights upon

[Table of Contents](#)

consummation of our initial business combination. Other than confirming that the rights delivered by a registered holder are valid, we will have no ability to avoid delivery of the shares underlying the rights. Nevertheless, there are no contractual penalties for failure to deliver securities to the holders of the rights upon consummation of an initial business combination. Additionally, in no event will we be required to net cash settle the rights. Accordingly, the rights may expire worthless.

We will not issue any fractional shares upon conversions of the rights once the units separate, and no cash will be payable in lieu thereof. As a result, a holder must have 20 rights to receive one share of common stock at the closing of the initial business combination. In the event that any holder would otherwise be entitled to any fractional share upon exchange of his, her or its rights, we will reserve the option, to the fullest extent permitted by applicable law, to deal with any such fractional entitlement at the relevant time as we see fit, which would include the rounding down of any entitlement to receive common stock to the nearest whole share (and in effect extinguishing any fractional entitlement), or the holder being entitled to hold any remaining fractional entitlement (without any share being issued) and to aggregate the same with any future fractional entitlement to receive shares in the company until the holder is entitled to receive a whole number. Any rounding down and extinguishment may be done with or without any in lieu cash payment or other compensation being made to the holder of the relevant rights, such that value received on exchange of the rights may be considered less than the value that the holder would otherwise expect to receive. All holders of rights shall be treated in the same manner with respect to the issuance of shares upon conversions of the rights.

We have agreed that, subject to applicable law, any action, proceeding or claim against us arising out of or relating in any way to the rights agreement will be brought and enforced in the courts of the State of New York or the United States District Court for the Southern District of New York, and we irrevocably submit to such jurisdiction, which jurisdiction will be the exclusive forum for any such action, proceeding or claim. See “Risk Factors — Each of our warrant agreement and rights agreement has designated the courts of the State of New York or the United States District Court for the Southern District of New York as the sole and exclusive forum for certain types of actions and proceedings that may be initiated by holders of our warrants and holders of our rights, which could limit the ability of warrant holders and rights holders to obtain a favorable judicial forum for disputes with our company.” This provision applies to claims under the Securities Act but does not apply to claims under the Exchange Act or any claim for which the federal district courts of the United States of America are the sole and exclusive forum.

Dividends

We have not paid any cash dividends on our shares of common stock to date and do not intend to pay cash dividends prior to the completion of a business combination. The payment of cash dividends in the future will be dependent upon our revenues and earnings, if any, capital requirements and general financial condition subsequent to completion of a business combination. The payment of any dividends subsequent to a business combination will be within the discretion of our then board of directors. It is the present intention of the Board to retain all earnings, if any, for use in our business operations and, accordingly, our board does not anticipate declaring any dividends in the foreseeable future.

Our Transfer Agent, Rights and Warrant Agent

The transfer agent for our securities, rights agent for our Rights and warrant agent for our Warrants is Continental Stock Transfer & Trust Company, 1 State Street, New York, New York 10004.

Listing of our Securities

The Units, Common Stock, Rights and Warrants are currently listed on the Nasdaq Stock Market, under the symbols “CLAQU,” “CLAQ,” “CLAQR” and “CLAQW,” respectively. The Units, Common Stock, Rights and Warrants commenced trading on the Nasdaq Stock Market separately on or about August 4, 2021.

Certain Anti-Takeover Provisions of Delaware Law and our Amended and Restated Certificate of Incorporation and By-Laws

We have opted out of Section 203 of the General Corporation Law of the State of Delaware (referred to as the “*DGCL*”). However, our amended and restated certificate of incorporation contains similar provisions providing that we may not engage in certain “business combinations” with any “interested stockholder” for a three-year period following the time that the stockholder became an interested stockholder, unless:

- prior to such time, our board of directors approved either the business combination or the transaction which resulted in the stockholder becoming an interested stockholder;
- upon consummation of the transaction that resulted in the stockholder becoming an interested stockholder, the interested stockholder owned at least 85% of our voting stock outstanding at the time the transaction commenced, excluding certain shares; or
- at or subsequent to that time, the business combination is approved by our board of directors and by the affirmative vote of holders of at least 66-2/3% of the outstanding voting stock that is not owned by the interested stockholder.

Generally, a “business combination” includes a merger, asset or stock sale or certain other transactions resulting in a financial benefit to the interested stockholder. Subject to certain exceptions, an “interested stockholder” is a person who, together with that person’s affiliates and associates, owns, or within the previous three years owned, 20% or more of our voting stock.

Under certain circumstances, this provision will make it more difficult for a person who would be an “interested stockholder” to effect various business combinations with a corporation for a three-year period. This provision may encourage companies interested in acquiring our company to negotiate in advance with our board of directors because the stockholder approval requirement would be avoided if our board of directors approves either the business combination or the transaction which results in the stockholder becoming an interested stockholder. These provisions also may have the effect of preventing changes in our board of directors and may make it more difficult to accomplish transactions which stockholders may otherwise deem to be in their best interests.

Our amended and restated certificate of incorporation provides that our cosponsors and their respective affiliates, any of their respective direct or indirect transferees of at least 20% of our outstanding common stock and any group as to which such persons are party to, do not constitute “interested stockholders” for purposes of this provision.

Special meeting of stockholders

Our bylaws provide that special meetings of our stockholders may be called only by a majority vote of our board of directors, by our chief executive officer or by our chairman.

Advance notice requirements for stockholder proposals and director nominations

Our bylaws provide that stockholders seeking to bring business before our annual meeting of stockholders, or to nominate candidates for election as directors at our annual meeting of stockholders must provide timely notice of their intent in writing. To be timely, a stockholder’s notice will need to be delivered to our principal executive offices not later than the close of business on the 90th day nor earlier than the opening of business on the 120th day prior to the scheduled date of the annual meeting of stockholders. Our bylaws also specify certain requirements as to the form and content of a stockholders’ meeting. These provisions may preclude our stockholders from bringing matters before our annual meeting of stockholders or from making nominations for directors at our annual meeting of stockholders.

Authorized, but unissued shares

Our authorized, but unissued common stock and preferred stock are available for future issuances without stockholder approval and could be utilized for a variety of corporate purposes, including future offerings (to raise additional capital), acquisitions and employee benefit plans. The existence of authorized but unissued and unreserved common stock and preferred stock could render more difficult or discourage an attempt to obtain control of us by means of a proxy contest, tender offer, merger or otherwise.

Exclusive Forum Selection

Our amended and restated certificate of incorporation provides that, unless we consent in writing to the selection of an alternative forum, the Court of Chancery of the State of Delaware shall be the sole and exclusive forum for any (1) derivative action or proceeding brought on behalf of our company, (2) action asserting a claim of breach of a fiduciary duty owed by any director, officer, employee or agent of our company to our company or our stockholders, (3) action asserting a claim arising pursuant to any provision of the DGCL or our amended and restated certificate of incorporation or our bylaws, or (4) action asserting a claim governed by the internal affairs doctrine, in each case subject to the Court of Chancery having personal jurisdiction over the indispensable parties named as defendants therein. Notwithstanding the foregoing, the inclusion of such provision in our amended and restated certificate of incorporation will not be deemed to be a waiver of our obligation to comply with federal securities laws, rules and regulations, and the provisions of this paragraph will not apply to suits brought to enforce any liability or duty created by the Exchange Act or any other claim for which the federal district courts of the United States of America shall be the sole and exclusive forum. Although we believe this provision benefits us by providing increased consistency in the application of Delaware law in the types of lawsuits to which it applies, the provision may have the effect of discouraging lawsuits against our directors and officers. Furthermore, the enforceability of choice of forum provisions in other companies' certificates of incorporation has been challenged in legal proceedings, and it is possible that a court could find these types of provisions to be inapplicable or unenforceable.

COMPARISON OF STOCKHOLDERS' RIGHTS

General

Nauticus Robotics, Inc. is incorporated under the laws of the State of Texas and the rights of Nauticus stockholders are governed by the laws of the State of Texas, including the Texas Business Organizations Code, Nauticus' charter and Nauticus' bylaws. As a result of the Business Combination, Nauticus stockholders who receive shares of the Combined Company's Common stock will become Combined Company stockholders. The Combined Company is incorporated under the laws of the State of Delaware and the rights of Combined Company stockholders are governed by the laws of the State of Delaware, including the DGCL, the Amended Charter and the Combined Company's bylaws. Thus, following the Business Combination, the rights of Nauticus' stockholders who become Combined Company stockholders in the Business Combination will be governed by Delaware law — they will no longer be governed by Nauticus' charter and Nauticus' bylaws — and instead will be governed by the Amended Charter and the Combined Company's bylaws.

Comparison of Stockholders' Rights

Set forth below is a summary comparison of certain key differences between the rights of Nauticus stockholders under Nauticus' current charter and Nauticus' current bylaws (left column), and the rights of Combined Company stockholders under forms of the Amended Charter and the Combined Company's bylaws (right column). The summary set forth below is not intended to be complete or to provide a comprehensive discussion of each company's governing documents. This summary is qualified in its entirety by reference to the full text of Nauticus' current charter and Nauticus' current bylaws, and forms of the Amended Charter, which is attached to this proxy statement/prospectus as *Annex B*, and the Combined Company's bylaws, which is attached to this proxy statement/prospectus as Exhibit 3.4, as well as the relevant provisions of the DGCL.

Nauticus	Combined Company
Authorized Capital Stock	
<p><i>Nauticus common stock.</i> Nauticus is currently authorized to issue 10,000,000 shares of common stock, par value \$0.001 per share.</p>	<p><i>Combined Company Class A common stock.</i> The Combined Company will be authorized to issue shares of capital stock, consisting of (i) _____, shares of Class A common stock, par value \$0.0001 per share, and (ii) _____ shares of preferred stock, par value \$0.0001 per share. As of _____ 2022, we expect there will be _____ shares of Combined Company Class A common stock outstanding following consummation of the Business Combination.</p>
<p><i>Nauticus preferred stock.</i> Nauticus is currently authorized to issue 1,060,226 shares of preferred stock, par value \$0.001 per share. As of _____, there are _____ preferred stock outstanding.</p>	<p><i>Combined Company preferred stock.</i> Following consummation of the Business Combination, the Combined Company is not expected to have any preferred stock outstanding.</p>
Conversion	
<p>Each share of preferred stock shall be convertible at the option of the holder thereof at an time and from time to time, and without payment of additional consideration, into a number of non-assessable shares of common stock as determined by dividing the applicable Original Issue Price by the then applicable Conversion Price.</p> <p>If there shall occur any reorganization, recapitalization, reclassification, consolidation or merger involving the Corporation in which the Common Stock is converted into or exchanged for securities, cash or other property then, following any such reorganization, recapitalization, reclassification, consolidation or merger, each share of Preferred Stock shall thereafter be convertible in lieu of the Common Stock into which it was convertible prior to such event into the kind and amount of securities, cash or other property which a holder of the number of</p>	<p>There are no conversion rights relating to the Combined Company preferred stock.</p> <p>Subject to the rights of holders of any series of preferred stock to elect directors, the number of directors that constitutes the Combined Company board of directors shall be determined from time to time by the board of directors. Directors need not be stockholders.</p>

Nauticus	Combined Company
<p>shares of Common Stock of the Corporation issuable upon conversion of one share of Preferred Stock immediately prior to such reorganization, recapitalization, reclassification, consolidation or merger would have been entitled to receive pursuant to such transaction; and, in such case, appropriate adjustment (as determined in good faith by the Board of Directors of the Corporation) shall be made with respect to the rights and interests thereafter of the holders of the Preferred Stock, to the end that the provisions related to conversion rights shall thereafter be applicable, as nearly as reasonably may be, in relation to any securities or other property thereafter deliverable upon the conversion of the Preferred Stock.</p>	
<p>Structure of Board; Election of Directors</p>	
<p>The holders of record of the shares of Series A Preferred Stock, exclusively and as a separate class, shall be entitled to elect, by majority vote, one director of the Corporation (the “Series A Director”). The holders of record of the shares of Series B Preferred Stock, exclusively and as a separate class, shall be entitled to elect, by majority vote, one director of the Corporation (the “Series B Director,” and together with the Series A Director, the “Preferred Directors”) and (c) the holders of record of the shares of Common Stock and of any other class or series of voting stock (including Preferred Stock), exclusively and voting together as a single class, shall be entitled to elect three directors of the Corporation.</p>	<p>Following the Business Combination, the members of the Combined Company board of directors will be as elected by the holders of common stock at the Special Meeting pursuant to the Director Election Proposal.</p>
<p>If the holders of shares of Preferred Stock and Common Stock, as the case may be, fail to elect a sufficient number of directors to fill all directorships for which they are entitled to elect directors, then any directorship not so filled shall remain vacant until such time as the holders of the Preferred Stock or Common Stock, as the case may be, elect a person to fill such directorship; and no such directorship may be filled by shareholders of the Corporation other than by the shareholders of the Corporation that are entitled to elect a person to fill such directorship, voting exclusively and as a separate class. The holders of record of the shares of Common Stock and of any other class or series of voting stock (including the Preferred Stock), exclusively and voting together as a single class, shall be entitled to elect the balance of the total number of directors of the Corporation.</p>	<p>Combined Company stockholders shall elect directors, each of whom shall hold office for an initial term ending in either 2022, 2023 or 2024, and thereafter for a term of three years or until his or her successor is duly elected and qualified, subject to such director’s earlier death, resignation, disqualification or removal. At all meetings of stockholders for the election of directors at which a quorum is present, a plurality of the votes cast shall be sufficient to elect directors. Subject to the special rights of the holders of one or more outstanding series of preferred stock to elect directors, any vacancy on the board of directors and any newly created directorships resulting from any increase in the number of directors shall be filled exclusively by the affirmative vote of a majority of the directors then in office, even though less than a quorum, or by a sole remaining director.</p>
<p>Removal of Directors</p>	
<p>Any director may be removed without cause by, and only by, the affirmative vote of the holders of the shares of the class or series of capital stock entitled to elect such director or directors, given either at a special meeting of such shareholders duly called for that purpose or pursuant to a written consent of shareholders.</p>	<p>Subject to the rights of holders of any series of preferred stock to elect directors, any director may be removed at any time, but only for cause and only by the affirmative vote of the holders of at least 66 and 2/3% of the voting power of the issued and outstanding shares of capital stock of the Combined Company entitled to vote in the election of directors, voting together as a single class.</p>

Nauticus	Combined Company
<p>Voting</p> <p>On any matter presented to the shareholders of the Corporation for their action or consideration at any meeting of shareholders of the Corporation (or by written consent of shareholders in lieu of meeting), each holder of outstanding shares of Preferred Stock shall be entitled to cast the number of votes equal to the number of whole shares of Common Stock into which the shares of Preferred Stock held by such holder are convertible as of the record date for determining shareholders entitled to vote on such matter. Except as provided by law or by the other provisions of the Certificate of Formation, holders of Preferred Stock shall vote together with the holders of Common Stock as a single class.</p> <p>Cumulative Voting</p> <p>Delaware law allows for cumulative voting only if provided for in Nauticus’ charter; however, Nauticus’ charter does not authorize cumulative voting.</p> <p>Vacancies on the Board of Directors</p> <p>Any vacancy occurring in the Board of Directors may be filled by election at an annual or special meeting of shareholders called for that purpose or may be filled by the affirmative vote of a majority of the remaining directors though less than a quorum of the Board of Directors. A director elected to fill a vacancy shall be elected for the unexpired term of his or her predecessor in office.</p> <p>A directorship to be filled by reason of an increase in the number of directors may be filled by election at an annual or special meeting of shareholders called for that purpose or may be filled by the Board of Directors for a term of office continuing only until the next election of one or more directors by the shareholders; provided that the Board of Directors may not fill more than two such directorships during the period between any two successive annual meetings of shareholders.</p> <p>Notwithstanding the above, whenever the holders of any class or series of shares or group of classes or series of shares are entitled to elect one or more directors by the provisions of the Certificate of Formation, any vacancies in such directorships and any newly created directorships of such class or series to be filled by reason of an increase in the number of such directors may be filled by the affirmative vote of a majority of the directors elected by such class or series, or by such group, then in office, or by a sole remaining director so elected, or by the vote of the holders of the outstanding shares of such class or series or of such group, and such directorships shall not in any case be filled by the vote of the remaining directors or the holders of the outstanding shares as a whole unless otherwise provided in the Certificate of Formation.</p>	
<p>212</p>	

Nauticus	Combined Company
Special Meeting of the Board of Directors	
<p>The Secretary shall call a special meeting of the Board of Directors whenever requested to do so by the President or by one (1) or more directors. Such special meeting shall be held at the date and time specified in the notice of meeting.</p>	<p>The Combined Company's bylaws provide that special meetings of the Combined Company board of directors may be called by the chairman of the Combined Company board of directors, the Chief Executive Officer, the President, the Secretary or a majority of the total number of directors constituting the board of directors.</p>
Amendment to Certificate of Incorporation	
<p>Under Delaware law, an amendment to a charter generally requires the approval of Nauticus' board of directors and a majority of the combined voting power of the then outstanding shares of voting stock, voting together as a single class.</p>	<p>The Amended Charter provides that the following provisions in Amended Charter may be amended, altered, repealed or rescinded only by the affirmative vote of the holders of at least 66 and 2/3% in voting power all the then outstanding shares of Combined Company's stock entitled to vote thereon, voting together as a single class: (i) Article IV of the Amended Charter relating to the Combined Company's capital stock; (ii) Article V of the Amended Charter relating to the board of directors; (iii) Article VI of the Amended Charter relating to relating to stockholder actions by written consent and annual and special stockholder meetings; (iv) Article VII of the Amended Charter relating to limitation of director liability; (v) Article VIII of the Amended Charter relating to indemnification; and (vi) Article IX of the Amended Charter relating to the amendment of the Amended Charter.</p>
<p>Except as otherwise required by law, holders of Common Stock, shall not be entitled to vote on any amendment to the Certificate of Formation that relates solely to the terms of one or more outstanding series of Preferred Stock if the holders of such affected series are entitled, either separately or together with the holders of one or more other such series, to vote thereon pursuant to the Certificate of Formation or pursuant to Chapter 21 of the Texas Business Organizations Code.</p>	<p>For any other amendment, the Amended Charter applies Delaware law, which allows an amendment to a charter generally with the affirmative vote of a majority of the outstanding shares of voting stock entitled to vote thereon, voting together as a single class.</p>
Amendment of Bylaws	
<p>The Board of Directors may amend or repeal these Bylaws, or adopt new Bylaws, unless the Certificate of Formation or the Texas Business Organizations Code reserves the power exclusively to the shareholders in whole or part, or the shareholders in amending, repealing, or adopting a particular bylaw expressly provide that the Board of Directors may not amend or repeal that bylaw. Unless the Certificate of Formation or a bylaw adopted by the shareholders provides otherwise as to all or some portion of these Bylaws, the shareholders may amend or repeal these Bylaws or adopt new Bylaws even though the Bylaws may also be amended, repealed, or adopted by the Board of Directors.</p>	<p>The Amended Charter provides that the board of directors is expressly authorized to adopt, amend or repeal the Combined Company's bylaws. In addition, the Combined Company may adopt, amend or repeal any bylaw with the affirmative vote of the holders of at least two-thirds (66 and 2/3%) of the voting power of all of the then outstanding shares of Combined Company's stock entitled to vote thereon.</p>
Quorum	
<p><i>Board of Directors.</i> At any meetings of the Nauticus board of directors, a majority of the directors shall constitute a quorum for all purposes.</p>	<p><i>Board of Directors.</i> At all meetings of Combined Company's board of directors, a majority of the directors will constitute a quorum for the transaction of business.</p>
<p><i>Stockholders.</i> A quorum shall be present for any matter to be presented at that meeting if the holders of a majority of the shares entitled to vote at the meeting are represented at the meeting in person or by proxy, unless otherwise provided by law or the Certificate of Formation. Notwithstanding anything to the contrary in these Bylaws or the Certificate of Formation, in no event shall a quorum of the shareholders consist of less than one-third (1/3) of the shares entitled to vote.</p>	<p><i>Stockholders.</i> The holders of record of a majority of the voting power of the Combined Company's capital stock issued and outstanding and entitled to vote, present in person or represented by proxy, constitute a quorum at all meetings of Combined Company stockholders for the transaction of business.</p>

Nauticus	Combined Company
Stockholder Action by Written Consent	
<p>Any action to be taken at any annual or special meeting of shareholders, or any action which may be taken at any annual or special meeting of shareholders, may be taken without a meeting, without prior notice, and without a vote, if a consent or consents in writing, setting forth the action so taken, shall be signed by the holder or holders of shares having not less than the minimum number of votes that would be necessary to take such action at a meeting at which holders of all shares entitled to vote on the action were present and voted.</p>	<p>Except with respect to the rights of any preferred stock provide in a certificate of designation from time to time, the Amended Charter provides that any action required or permitted to be taken by the stockholders of the Combined Company must be effected at any annual or special meeting of stockholders may not be taken by written consent in lieu of a meeting.</p>
<p>Every written consent signed by the holders of less than all the shares entitled to vote with respect to the action that is the subject of the consent shall bear the date of signature of each shareholder who signs the consent. No written consent signed by the holder of less than all the shares entitled to vote with respect to the action that is the subject of the consent shall be effective to take the action that is the subject of the consent unless, within sixty (60) days after the date of the earliest dated consent delivered to the Corporation in a manner required by these Bylaws, a consent or consents signed by the holder or holders of shares having not less than the minimum number of votes that would be necessary to take the action that is the subject of the consent are delivered to the Corporation by delivery to its registered office, registered agent, principal place of business, transfer agent, registrar, exchange agent or an officer or agent of the Corporation having custody of the books in which proceedings of meetings of shareholders are recorded. Delivery shall be by hand or certified or registered mail, return receipt requested. Delivery to the Corporation's principal place of business shall be addressed to the President or principal executive officer of the Corporation.</p>	
<p>Prompt notice of the taking of any action by shareholders without a meeting by less than unanimous written consent shall be given to those shareholders who did not consent in writing to the action.</p>	
Special Stockholder Meetings	
<p>Special meetings of the shareholders may be called (1) by the President, any Vice President, the Board of Directors, or (2) by the holders of at least ten (10) percent of all the shares entitled to vote at the proposed special meeting, unless the Corporation's Certificate of Formation provides for a number of shares greater than or less than ten (10) percent, in which event special meetings of the shareholders may be called by the holders of at least the percentage of shares so specified in the Certificate of Formation, but in no event shall the Certificate of Formation provide for a number of shares greater than fifty (50) percent. The record date for determining shareholders entitled to call a special meeting is the date the first shareholder signs the notice of that meeting. Only business within the purpose or purposes described in the notice or executed waiver of notice may be conducted at a special meeting of the shareholders. Any person or persons entitled hereunder to call a special meeting of</p>	<p>The Amended Charter provides that, subject to the Stockholder Agreement, special meetings of stockholders for any purpose or purposes may be called at any time only by or at the direction of the board of directors, the chairperson of the board of directors, the chief executive officer or the president.</p>

Nauticus	Combined Company
<p>shareholders may do so only by written request sent by certified mail or delivered in person to the President or Secretary. The officer receiving the written request shall within ten (10) days from the date of its receipt cause notice of the meeting to be given in the manner provided by these Bylaws to all shareholders entitled to vote at the meeting. If the officer does not give notice of the meeting within ten (10) days after the date of receipt of the written request, the person or persons calling the meeting may fix the time of meeting and give the notice in the manner provided in these Bylaws. Nothing contained in this section shall be construed as limiting, fixing, or affecting the time or date when a meeting of shareholders called by action of the Board of Directors may be held.</p>	
<p>Notice of Stockholder Meetings</p>	
<p>Written or printed notice stating the place, day and hour of the meeting, the means of any remote communications by which shareholders may be considered present and may vote at the meeting, and, in case of a special meeting, the purpose or purposes for which the meeting is called, shall be given not less than ten (10) days nor more than sixty (60) days before the date of the meeting, personally, by electronic transmission, or by mail, by or at the direction of the President, the Secretary, or the officer or person calling the meeting, to each shareholder entitled to vote at such meeting.</p>	<p>Whenever stockholders are required or permitted to take any action at a meeting, a timely notice in writing or by electronic transmission, in the manner provided in Section 232 of the DGCL, of the meeting, which shall state the place, if any, date and time of the meeting, the means of remote communications, if any, by which stockholders and proxyholders may be deemed to be present in person and vote at such meeting, the record date for determining the stockholders entitled to vote at the meeting, if such date is different from the record date for determining stockholders entitled to notice of the meeting, and, in the case of a special meeting, the purposes for which the meeting is called, shall be mailed to or transmitted electronically by the Secretary of the Combined Company to each stockholder of record entitled to vote thereat as of the record date for determining the stockholders entitled to notice of the meeting. Unless otherwise provided by law, the charter or the bylaws, notice shall be given not less than ten (10) nor more than sixty (60) days before the date of the meeting to each stockholder entitled to vote at such meeting as of the record date for determining the stockholders entitled to notice of the meeting.</p>
<p>The Corporation shall notify each shareholder, whether or not entitled to vote, of any meeting of shareholders at which a plan of merger or exchange is to be submitted for approval in accordance with section 6.051 of the Texas Business Organizations Code. The notice shall be given at least twenty (20) days before the meeting and shall state that the purpose, or one of the purposes, of the meeting is to consider the plan of merger or exchange and shall contain or be accompanied by a copy or summary of the plan.</p>	
<p>Stockholder Proposals (Other than Nomination of Persons for Election as Directors)</p>	
	<p>No business may be transacted at an annual meeting of stockholders, other than business that is either (i) specified in Combined Company's notice of meeting (or any supplement thereto) delivered pursuant to the Combined Company's bylaws, (ii) properly brought before the annual meeting by or at the direction of the board of directors or (iii) otherwise properly brought before the annual meeting by any stockholder of the Combined Company who is entitled to vote at the meeting, who complies with the notice procedures set forth in the Combined Company's bylaws and who is a stockholder of record at the time such notice is delivered to the Secretary of the Combined Company.</p> <p>The stockholder must (i) give timely notice thereof in proper written form to the Secretary of the Combined Company, and (ii) the business must be a proper matter for stockholder action. To be timely, a stockholder's notice must be received by the Secretary at the principal</p>

Nauticus	Combined Company
	<p>executive offices of the Combined Company not less than ninety (90) or more than one-hundred twenty (120) days before the meeting. The public announcement of an adjournment or postponement of an annual meeting shall not commence a new time period (or extend any time period) for the giving of a stockholder's notice. Additionally, the stockholder must provide information pursuant to the advance notice provisions in the Combined Company's bylaws.</p>
Stockholder Nominations of Persons for Election as Directors	<p>Nominations of persons for election to the Combined Company board of directors may be made at an annual meeting of stockholders, or at any special meeting of stockholders called for the purpose of electing directors as set forth in Combined Company's notice of such special meeting, (i) by or at the direction of the Combined Company board of directors or (ii) by any stockholder of the Combined Company who is entitled to vote at the meeting, who complies with the notice procedures set forth in the bylaws and who is a stockholder of record at the time such notice is delivered to the Secretary of the Combined Company.</p> <p>For a nomination to be made by a stockholder, such stockholder must have given timely notice thereof in proper written form to the Secretary. To be timely, a stockholder's notice to the Secretary must be received by the Secretary at the principal executive offices of the Combined Company (i) in the case of an annual meeting, not later than the close of business not less than ninety (90) days nor more than one hundred and twenty (120) days prior to the first anniversary of the preceding year's annual meeting or, if the number of directors to be elected to the board of directors is increased and the first public announcement naming all of the nominees for directors or specifying the size of the increased board of directors is less than 100 days prior to the meeting, the close of business on the 10th day following the day on which public announcement of the date of such meeting is first made; and (ii) in the case of a special meeting of stockholders called for the purpose of electing directors, not later than the close of business on the 10th day following the day on which public announcement of the date of the special meeting is first made by Combined Company. In no event shall the public announcement of an adjournment or postponement of an annual meeting or special meeting commence a new time period (or extend any time period) for the giving of a stockholder's notice. Additionally, the stockholder must provide information pursuant to the advance notice provisions in the Combined Company's bylaws.</p>

Nauticus	Combined Company
Limitation of Liability of Directors and Officers	
<p>To the fullest extent permitted by law, a director of the Corporation shall not be personally liable to the Corporation or its shareholders for monetary damages for breach of fiduciary duty as a director. If Chapter 21 of the Texas Business Organizations Code or any other law of the State of Texas is amended after approval by the shareholders to authorize corporate action further eliminating or limiting the personal liability of directors, then the liability of a director of the Corporation shall be eliminated or limited to the fullest extent permitted by Chapter 21 of the Texas Business Organizations Code as so amended. Any repeal or modification of the foregoing by the shareholders of the Corporation shall not adversely affect any right or protection of a director of the Corporation existing at the time of, or increase the liability of any director of the Corporation with respect to any acts or omissions of such director occurring prior to, such repeal or modification.</p>	<p>A director of the Combined Company shall not be personally liable to Combined Company or its stockholders for monetary damages for breach of fiduciary duty as a director, except to the extent such exemption from liability or limitation thereof is not permitted under the DGCL as the same now exists or may hereafter be amended. The amendment, repeal or modification of this provision in Amended Charter nor, to the fullest extent permitted by the DGCL, any modification of law shall eliminate, reduce or otherwise adversely affect any right or protection of a current or former director of the Combined Company existing at the time of such amendment, repeal, adoption or modification.</p>
Indemnification of Directors, Officers, Employees and Agents	
<p>Nauticus shall indemnify any person for any proceeding (other than an action by or in the right of Nauticus) by reason of the fact that such person is or was a director or officer of Nauticus, or while director or officer of Nauticus, is or was serving at the request of Nauticus as a director, officer, employee or agent, against all liability and loss suffered and expenses (including attorneys' fees) reasonably incurred by such person in such proceeding.</p>	<p>Combined Company will indemnify any person for any proceeding by reason of being a director or officer of the Combined Company or, while a director or officer, is or was serving at the request of the Combined Company as a director, officer, employee, agent or trustee of another corporation or of a partnership, joint venture, trust, enterprise or non-profit entity, including service with respect to employee benefit plans.</p>
	<p>The right to indemnification covers all expense, liability and loss (including attorneys' fees, judgments, fines, ERISA excise taxes or penalties and amounts paid in settlement) actually and reasonably incurred or suffered by such indemnitee in connection with such proceeding. It also includes the right to be paid by Combined Company the expenses (including attorney's fees) incurred in defending or otherwise participating in any such proceeding in advance of its final disposition; <i>provided, however</i>, that, if the DGCL requires, an advancement of expenses will be made only upon delivery to Combined Company of an undertaking, by or on behalf of the indemnitee, to repay all amounts so advanced if it will ultimately be determined by final judicial decision from which there is no further right to appeal that the indemnitee is not entitled to be indemnified for the expenses. Such rights will continue as to an indemnitee who has ceased to be a director or officer and will inure to the benefit of his or her heirs, executors and administrators.</p>

Nauticus	Combined Company
Dividends, Distributions and Stock Repurchases	
<p>The Board of Directors may declare at any annual, regular or special meeting of the Board of Directors and the Corporation may pay, dividends on the outstanding shares in cash, property Of in the shares of the Corporation to the extent permitted by, and subject to the provisions of, the laws of the State of Texas</p>	<p>Subject to the rights of the holders of Combined Company preferred stock, and to the other provisions of the Amended Charter, dividends and other distributions in cash, property or capital stock of the Combined Company may be declared and paid ratably on the Class A common stock out of the assets of the Combined Company which are legally available for this purpose at such times and in such amounts as the board of directors in its discretion shall determine.</p>
<p>The Board of Directors may by resolution, create a reserve or reserves out of the Corporation's surplus or designate or allocate any part or all of the Corporation's surplus in any manner for any proper purpose or purposes, including but not limited to creating a reserve fund to meet contingencies or for equalizing dividends or for repairing or maintaining any property of the Corporation, and may increase, decrease, or abolish any such reserve, designation, or allocation in the same manner.</p>	
Liquidation	
<p>In the event of any voluntary or involuntary liquidation, dissolution or winding up of the Corporation or Deemed Liquidation Event, the holders of shares of Preferred Stock then outstanding shall be entitled to be paid out of the assets of the Corporation available for distribution to its shareholders before any payment shall be made to the holders of Common Stock by reason of their ownership thereof, an amount per share equal to. the applicable Original Issue Price, plus any dividends declared but unpaid thereon.</p>	<p>The Amended Charter provides that, in the event of any liquidation, dissolution or winding up of the Combined Company, the holders of shares of Combined Company Class A common stock are entitled to receive, subject to the preferential rights as to distributions upon such liquidation event of each of the creditors of the Combined Company and the holders of all classes or series of stock at the time outstanding, their ratable and proportionate share of the remaining assets of the Combined Company.</p>
<p>After the payment of all preferential amounts required to be paid to the holders of shares of Preferred Stock the remaining assets of the Corporation available for distribution to its shareholders shall be distributed among the holders of shares of Preferred Stock and Common Stock, pro rata based on the number of shares held by each such holder, treating for this purpose all such securities as if they had been converted to Common Stock pursuant to the terms of the Certificate of Formation immediately prior to such liquidation, dissolution or winding up _of the Corporation.</p>	
<p>The value of such property, rights or securities shall be determined in good faith by the Board of Directors of the Corporation. If at least one of the Preferred Directors or the holders of at least 75% of the then outstanding shares of Preferred Stock object to the valuation by the Board of Directors, then the value shall be the fair market value as mutually determined by the Corporation and holders of at least 75% of the then outstanding shares of Preferred Stock. If the Corporation and such holders are unable to reach an agreement within 20 days, then the fair market value shall be established by an independent appraisal. The independent appraiser shall be approved by the Board of Directors and the holders of at least 75% of the then outstanding shares of Preferred Stock. The Corporation shall pay the costs and fees of such appraiser.</p>	

Nauticus	Combined Company
Stockholder Rights Plan	
<p>The Company does not have a stockholder rights plan currently in effect.</p>	<p>While Delaware law does not include a statutory provision expressly validating stockholder rights plans, such plans have generally been upheld by court decisions applying Delaware law.</p> <p>The Combined Company will not have a stockholder rights plan in effect, but under the DGCL, the Combined Company's board of directors could adopt such a plan without stockholder approval.</p>
Preemptive Rights	
<p>There are no preemptive rights relating to shares of the Company.</p>	<p>There are no preemptive rights relating to shares of Combined Company common stock.</p>
Duties of Directors	
<p>Under Texas law, the standards of conduct for directors have developed through Texas court case law. Generally, directors of Texas corporations are subject to a duty of loyalty, duty of care, and duty of obedience. The duty of loyalty requires directors to refrain from self-dealing, the duty of care requires directors in managing Nauticus' affairs to use that level of care which ordinarily careful and prudent persons would use in similar circumstances, the duty of obedience requires obligation to follow the law. When directors act consistently with their duties of loyalty, care, and obedience their decisions generally are presumed to be valid under the business judgment rule.</p>	<p>Under Delaware law, the standards of conduct for directors have developed through Delaware court case law. Generally, directors of Delaware corporations are subject to a duty of loyalty and a duty of care. The duty of loyalty requires directors to refrain from self-dealing, and the duty of care requires directors in managing Combined Company's affairs to use that level of care which ordinarily careful and prudent persons would use in similar circumstances. When directors act consistently with their duties of loyalty and care, their decisions generally are presumed to be valid under the business judgment rule.</p>
<p>Nauticus' board of directors may exercise all such powers of Nauticus and do all such lawful acts and things as are not by statute or Nauticus' charter or bylaws directed or required to be exercised or done solely by the stockholders.</p>	<p>The Combined Company's board of directors may exercise all such authority and powers of the Combined Company and do all such lawful acts and things as are not by statute or the Amended Charter directed or required to be exercised or done solely by the stockholders.</p>
Inspection of Books and Records; Stockholder Lists	
<p><i>Inspection.</i> Under the Texas Business Organizations Code, any stockholder who has held shares for at least six months immediately preceding the demand, or who holds at least 5% of the outstanding shares may, in person or by an agent, has, upon written demand under oath stating the purpose thereof, the right during the usual hours for business to inspect for any proper purpose and to make copies and extracts from Nauticus' stock ledger, a list of its stockholders and its other books and records.</p>	<p><i>Inspection.</i> Under Section 220 of the DGCL, any stockholder, in person or by attorney or other agent, has, upon written demand under oath stating the purpose thereof, the right during the usual hours for business to inspect for any proper purpose and to make copies and extracts from the Combined Company's stock ledger, a list of its stockholders and its other books and records.</p>
<p><i>Voting List.</i> The officer or agent having charge of the share transfer records for shares of the Corporation shall make, at least ten (10) days before each meeting of shareholders, a complete list of the shareholders entitled to vote at such meeting or any adjournment thereof, arranged in alphabetical order, with the address of and the number of shares held by each, which list, for a period of ten (10) days prior to such meeting, shall be kept on file at the registered office or principal place of business of the Corporation and shall be subject to inspection by any shareholder at any time during usual business hours. Alternatively, the list of the shareholders may be kept on a reasonably accessible electronic network, if the information required to gain access to the list is provided</p>	<p><i>Voting List.</i> The Combined Company will prepare, at least ten (10) days before every meeting of the stockholders, a complete list of the stockholders entitled to vote at the meeting. The list will be open to the examination of any stockholder, for any purpose germane to the meeting at least ten (10) days prior to the meeting either (i) on a reasonably accessible electronic network or (ii) during ordinary business hours at the principal place of business of the Combined Company. If the meeting is to be held at a place, then a list of stockholders entitled to vote at the meeting will be produced and kept at the time and place of the meeting during the whole time thereof and may be examined by any stockholder who is present.</p>

Nauticus	Combined Company
<p>with the notice of the meeting. This does not require the Corporation to include any electronic contact information of any shareholder on the list. If the Corporation elects to make the list available on an electronic network, the Corporation shall take reasonable steps to ensure that the information is available only to shareholders of the Corporation. Such list shall also be produced and kept open at the time and place of the meeting and shall be subject to the inspection of any shareholder during the whole time of the meeting. If the meeting is held by means of remote communication, the list must be open to the examination of any shareholder for the duration of the meeting on a reasonably accessible electronic network, and the information required to access the list must be provided to shareholders with the notice of the meeting. The original share transfer records shall be prima-facie evidence as to who are the shareholders entitled to examine such list or transfer records or to vote at any meeting of shareholders. However, failure to prepare and make the list available in the manner provided above shall not affect the validity of any action taken at the meeting.</p>	
<p>Choice of Forum The articles of incorporation and bylaws are silent as to an exclusive forum.</p>	<p>The articles of incorporation and bylaws are silent as to an exclusive forum.</p>

DIRECTORS AND EXECUTIVE OFFICERS OF CLAQ**Current Directors and Executive Officers**

CLAQ's directors and executive officers are as follows as of the Record Date:

Name	Age	Position
Eli Spiro	50	Chief Executive Officer and Director
Richard Fitzgerald	58	Chief Financial Officer
Louis Buffalino	66	Chief Operating Officer and Director
Ankur Dhanuka	34	Chief Technology Officer
Jon Najarian	64	Chairman of the Board
Governor Bill Richardson	74	Vice Chairman of the Board
Brendan Riley	52	Director
Britt E. Ide	50	Director
Jonas Grossman	46	Director
Douglas Cole	66	Director

Eli Spiro is our Chief Executive Officer and a member of our Board of Directors and has over 23 years of capital markets experience. Since 2010, Mr. Spiro has served as the Chief Executive Officer of Axxcess Capital Partners, a boutique investment banking firm he co-founded. At Axxcess, Mr. Spiro has closed over \$1.5 billion of transactions since inception. He was involved in a number of transactions in the clean energy space including his role as President of Axxcess Energy Group, investing in a business applying proprietary technology to reduce energy expenses. Mr. Spiro was also involved in the development of an organic, hydroponic greenhouse business producing leafy greens. He worked with clients on several multi-stage waste-to-energy projects that focus on transforming waste to energy to end products and services, as well as carbon credit mitigation and monetization. Notable public transactions that Mr. Spiro led include Facebank - buyside advisor in conjunction with acquisition of FUBOTV (NYSE:FUBO) and Service Finance — sellside advisor in connection with its sale to Element Capital (TSX:ECN). Prior to Axxcess, Mr. Spiro was an investment banker at Goldman Sachs where he was a Vice President in the Financial Institutions Group advising multiple clients on sellside and buyside M&A transactions. Prior to Goldman Sachs, Mr. Spiro was Managing Director & National Sales Manager at GE Commercial Finance. He was responsible for over \$4.2 billion of high-profile acquisitions across a number of GE Capital business units. From January 2020 through October 2020, Mr. Spiro served on the Board of Directors of JourneyPure, LLC, a healthcare provider focused on addiction treatment. Mr. Spiro received his B.A.S. in Business Administration from York University in Toronto and received his joint LLB/MBA from Osgoode Hall Law School and the Schulich School of Business in Toronto.

Richard Fitzgerald is our Chief Financial Officer and has over 35 years of progressive finance, capital markets, and operations leadership experience supporting both public and private companies, predominately within the life sciences industry. Mr. Fitzgerald has a track record of delivering positive results and driving shareholder value through execution of IPO's, secondary securities' offerings, private venture financings and strategic M&A and partnering transactions. Since November 2021, Mr. Fitzgerald has served as the Chief Financial Officer at 22nd Century Group, Inc. (Nasdaq: XXII), a leading agricultural biotechnology company focused on tobacco harm reduction, reduced nicotine tobacco, and improving health and wellness through modern plant science. Mr. Fitzgerald previously provided financial and capital markets consulting services to several private life science companies from March 2021 through October 2021. In March 2020, Mr. Fitzgerald co-founded and served as the Chief Financial Officer of SIRPant Immunotherapeutics, a private immunology company, through February 2021. From September 2020 through November 2020, Mr. Fitzgerald served as Chief Financial Officer at Immunome, Inc. (Nasdaq: IMNM), a novel immunology focused therapeutics company that completed its IPO and Nasdaq listing in October 2020. From October 2017 through August 2019, Mr. Fitzgerald served as the Interim Chief Financial Officer and then Chief Financial Officer of Sesen Bio (Nasdaq: SESN), a late-stage clinical company advancing fusion protein therapies. He also served as a Consulting Chief Financial Officer for Annovis, Inc. (NYSE:ANVS) from June 2017 through December 2017. From October 2015 through March 2017, Mr. Fitzgerald served as the Chief Financial Officer of PAVmed Inc. (Nasdaq: PAVM), where he successfully completed the company's IPO and Nasdaq listing, in 2016. Prior to 2015, Mr. Fitzgerald held Chief Financial Officer and senior financial positions at TechPrecision Inc. (OTCBB: TPCS), Nucleonics Inc. (sold to Alnylam Pharmaceuticals Inc. (Nasdaq: ALNY)), and Exelon Corporation (NYSE: EXC). Mr. Fitzgerald received his B.S. in Business Administration and Accounting from Bucknell University. He previously served as Co-Chair of the Biotechnology Innovation Organization's CFO/Tax Committee, which lobbied for capital

markets and tax reforms in support of the life science industry. Mr. Fitzgerald is a member of the American and Pennsylvania Institutes of Public Accounting and a current Board member of the Bucknell University Alumni Association Board of Directors and serves on the Finance Committee of FORCE BLUE TEAM.ORG.

Louis Buffalino is our Chief Operating Officer and a member of our Board of Directors and has over 30 years of experience in real estate services, project and development services, facility services and capital markets. Since December 2019, Mr. Buffalino has been an Independent Board Member for Blink Charging Company (NASDAQ: BLNK), an owner, operator and provider of electric vehicle charging equipment and networked electric vehicle charging services. The business is designed to accelerate the adoption of public electric vehicle charging. Since 2015, Mr. Buffalino has served as a Senior Vice President at Cushman & Wakefield's (NYSE: CWK) New York office where he is instrumental in cultivating new relationships in domestic and international markets. Before Cushman & Wakefield, Mr. Buffalino served as a Senior Vice President and First Vice President for JLL (NYSE: JLL) and CBRE (NYSE: CBRE) respectively. Mr. Buffalino graduated from Providence College with a B.A. in Political Science.

Ankur Dhanuka has been our Chief Technology Officer, since January 2021, and has almost a decade of experience in the Energy sector, specifically clean energy technologies (nuclear, solar, wind, storage, bio-mass, waste-to-energy, and electric vehicles). Since July 2021, Mr. Dhanuka has served as a consultant to The World Bank. Mr. Dhanuka is a clean energy technology and policy expert who previously worked as a research assistant at Harvard University's Belfer Center from July 2020 through June 2021. His work at the Belfer Center was to identify clean energy technologies that will facilitate deep-decarbonization in the US by 2050. From December 2018 through April 2020, Mr. Dhanuka served as a Harvard Graduate Fellow with the Ministry of Forests, Environment and Climate Change, a ministry of the Indian Government. He previously led a feasibility assessment of Electric Vehicles, renewables, storage, and carbon-capture technologies to achieve 5GT+ CO2e emissions reduction. Mr. Dhanuka also worked in the energy team at Walmart Inc. from May 2019 to August 2019. From 2010 through August 2018, Mr. Dhanuka served as a Manager for Indian Oil Corporation Limited, India, where he led several clean energy initiatives such as solar, wind, nuclear and energy storage from August 2010 to August 2018. He recently graduated with a Master's degree in Public Policy with a concentration in Business and Government from Harvard University's John F. Kennedy School of Government. During his time at the Kennedy School, Mr. Dhanuka served as a Summer Associate for Walmart in their Renewable Energy Origination: Technology and Policy Innovation program in addition to advising the Government of Jharkhand, India on climate change policy and advising the London's Transport Department for transition to clean mobility by 2040. Mr. Dhanuka earned his Bachelor of Engineering (B.E.) in Electrical and Electronics Engineering from the Birla Institute of Technology, Mesra.

Jon Najarian is the Chairman of our Board of Directors, and has 38 years of experience in the securities and futures markets. Mr. Najarian is the Co-Founder of Market Rebellion (previously Investitude and OptionMonster). He has served on the leadership team at Market Rebellion, since its founding in 2016. Additionally, he has held an active role as a paid contributor to and broadcaster with CNBC Business Television. Mr. Najarian has been a broadcaster at CNBC since January 2007. Previously, Mr. Najarian co-founded TradeMonster, a securities and futures brokerage as well as education and subscription businesses. He went on to sell the brokerage portion of TradeMonster to E*TRADE Financial Corp. (NASDAQ: ETFX) in 2016. Prior to TradeMonster, Mr. Najarian owned Mercury Trading, a market-making firm at the Chicago Board Options Exchange (CBOE), which he eventually sold to Citadel, one of the world's largest hedge funds. During that time Mr. Najarian developed the Heat Seeker algorithm, a framework used to identify unusual activity in stock, options and futures markets. Mr. Najarian previously worked as a trader and Partner for Letco, where he ran spreading operations. He began his financial career working on the floor of the Chicago Board of Options Exchange. Mr. Najarian attended Gusavus Adolphus College where he played football, and went on to play linebacker for the Chicago Bears.

Governor Bill Richardson has been the Vice Chairman of our Board of Directors since February 2021. Governor Richardson has been an advisor for Tecnicas Reunidas since March 2011, Everis since November 2017, and United Against Nuclear Iran, a non-profit advocacy organization, since November 2016. After his second term of governorship ended in 2011, Governor Richardson joined the boards of Global Political Strategies (an APCO Worldwide company), the World Resources Institute, the National Council for Science and the Environment, and was on the international advisory board for Abengoa. Since exiting his last elected office in 2011, Governor Richardson has focused principally on private consulting and serving on boards of directors. He currently is an independent director at Técnicas Reunidas where he has served on the board of directors, since 2011. In April 2021, Governor Richardson was appointed to the Board of Directors, as Board Chair, of D-Wave Government, Inc., a subsidiary of D-Wave Systems, Inc., a developer and provider of quantum computing systems and services. Governor Richardson served as a Senior Fellow at Yale's Jackson Institute for Global Affairs during the Fall 2018 through Spring 2019 semesters. In 2012, he joined the advisory

boards of Grow Energy and Refugees International in addition to becoming Chairman of the Board of Directors of Car Charging Group, the largest independent owner and operator of public electric vehicle charging stations in the United States. Governor Bill Richardson served as governor of New Mexico from January 2003 to January 2011. He held the position of Secretary of the United States Department of Energy from August 1998 to January 2001. In February 1997, Governor Richardson became the United States Ambassador to the United Nations, serving until moving onto the Department of Energy in August 1998. He was a member of the U.S. House of Representatives from New Mexico's 3rd district from January 1983 to February 1997. Governor Richardson graduated from Tufts University in 1970 and the Fletcher School of Law & Diplomacy in 1971. Governor Richardson is qualified to serve as Vice Chairman of the Board of Directors based on his political experience within the clean energy sector.

Brendan Riley is a member of our Board of Directors and our Senior Electric Vehicle Advisor. Mr. Riley has over 25 years of experience in Business Development, Sales Strategy and Operations. Since 2016, Mr. Riley has served as the President and also a board member, of GreenPower Motor Company (NASDAQ: GP), a company that designs, builds and sells medium and heavy duty electric vehicles such as buses and trucks since October 2016 and July 2019, respectively. From October 2012 to October 2016, Mr. Riley was the North American Vice President of BYD Motors (Build Your Dreams), where he ran multiple electric vehicle business units including the material handling, truck and the bus groups. At BYD, Mr. Riley secured the largest privately funded electric bus contract in North America two years in a row. Mr. Riley started his career at PTB Sales, where he worked for 15 years and held the position of Vice President of Sales and Marketing.

Britt E. Ide is a member of our Board of Directors and has almost 30 years of experience as an engineer, lawyer and business leader working on all sides of energy issues. Since 2010, Ms. Ide has served as the Chief Executive Officer of Ide Energy & Strategy since April 2011, where she consults on energy, sustainability, and ESG. Since 2017, Ms. Ide has served on the Board of Directors and the Human Capital and Governance Committees of NorthWestern Energy (Nasdaq: NWE), a gas and electric utility. Ms. Ide was appointed to the Board of Directors of Atlis Motor Vehicles in April 2021. Additionally, Ms. Ide has served on the Advisory Board of 3Degrees, a Bay Area based BCorp that helps businesses (including Duke Energy, Lyft and Microsoft) meet their climate goals. She is also a Clean Energy Board Member for a US Department of Energy/MIT/Stanford collaboration. Ms. Ide was named to the Fulbright Roster of Specialists and was an invited speaker in Santiago, Chile on climate and corporate governance to the Columbia University Global Center, the Chilean Department of Energy and corporate directors. Her current nonprofit board service includes the Energy Policy Institute, a DOE National Laboratory collaboration with four universities. Ms. Britt holds a B.S. in Mechanical Engineering, an M.S. in Environmental Engineering, and a J.D.

Jonas Grossman is a member of our Board of Directors and serves as Managing Partner and President of Chardan, where he oversees the firm's banking and capital markets activities. He has broad transactional experience having led or managed more than 500 transactions since joining Chardan in 2003. Under Mr. Grossman's leadership, Chardan has become one of the most notable underwriters, advisors, and sponsors of SPACs, having been involved in 115 SPAC IPO transactions raising over \$14.6 billion, serving as advisor to over 30 business combination transactions with SPACs, and has sponsored or co-sponsored 15 SPACs. Additionally, Mr. Grossman is Chief Executive Officer of Chardan's 11th sponsored or co-sponsored SPAC, Chardan NexTech Acquisition 2 Corp, a disruptive technology and healthcare focused SPAC. Mr. Grossman has also served as Chief Executive Officer of Chardan NexTech 1 Acquisition Corp., a publicly filed SPAC, since July 2020. He served as President and Chief Executive Officer of Chardan Healthcare Acquisition 2 Corp. until its merger in September 2021 with Renovacor, Inc. (NYSE: RCOR). He is currently a director of Renovacor. He also served as President and Chief Executive Officer of Chardan Healthcare Acquisition Corp. from March 2018 until its merger in October 2019 with BiomX Ltd. (NYSE: PHGE). Mr. Grossman is currently a director of BiomX. Mr. Grossman was a Founder and Director of LifeSci Acquisition Corp. from March 2020 until the close of its business combination with Vincer Pharma, Inc. (NASDAQ: VINC) in December 2020. He has served as a Director to Ventoux CCM Acquisition Corp. since December 2020. From 2001 until 2003, Mr. Grossman worked at Ramius Capital Group, LLC, a global multi-strategy hedge fund where he served as Vice President and Head Trader. Mr. Grossman holds a B.A. in Economics from Cornell University and an M.B.A. from NYU's Stern School of Business. He has served on the board of directors for UNICEF since December 2016.

Douglas Cole is a member of our Board of Directors and our Senior Renewable Advisor. Mr. Cole was the CEO of American Battery Technology Company (OTCMKTS: ABML) from August 2017 through August 2021. As CEO, he worked with the team to create, plan, implement and integrate the strategic direction of the company. He also served as Chairman of the Board, from 2017 through February 2022, to execute on initiatives, notably the lithium-ion battery recycling and extraction technologies, and environmentally sustainable primary resource production. He has served

[Table of Contents](#)

on the Board of Directors of eWellness Healthcare Corporation (OTCMKTS: EWLL) since January 2017, VOISE since January 2018, and Sysorx, Inc. (OTCMKTS: SYSX) since January 2020. Previously, Mr. Cole has held various executive roles, including Chairman, Executive Vice Chairman, Chief Executive Officer and President of multiple public corporations. During the period between 1991 and 1996 he was the CEO of HealthSoft and he also founded and operated Great Bear Technology, which acquired Sony Image Soft and Starpress, then went public and eventually sold to GraphixZone. In 1995, Mr. Cole was honored by NEA, a leading venture capital firm, as CEO of the year. In 1997 he became CEO of NetAmerica until merging in 1999. Since graduating from the university, he has been highly active with the University of California, Berkeley, mentoring early-stage technology companies. He obtained his BA in Social Sciences from UC Berkeley. Mr. Cole Doug has extensive experience in global M&A and global distributions. He obtained his BA in Social Sciences from UC Berkeley.

CleanTech Sponsor has agreed with one of its members to re-nominate each of our current directors for any election of directors we hold prior to the closing our initial business combination, and that it will vote in favor of the election of such persons.

Advisors

We have the following advisors but they have no fiduciary obligations to us and are not obligated to provide us with any advice or service.

Allen “Al” R. Weiss is one of our Senior Advisors and has over four decades of experience in the entertainment industry. As a former consultant at Apollo Capital Management, a private equity firm, Mr. Weiss was involved in company analyses to support potential acquisitions and management. Mr. Weiss had a 39-year career at Disney, his last position being President of Worldwide Operations for Disney’s \$10 Billion+/95,000 employee Walt Disney Parks and Resorts business. He was responsible for the company’s theme parks and resorts including the Walt Disney World Resort, Disneyland Resort, and Disneyland Resort Paris, Disney Cruise Line, Disney Vacation Club, “Adventures by Disney”, and the line-of-business responsibility for Hong Kong Disneyland Resort and Tokyo Disney Resort. During his tenure as President, Mr. Weiss directed the largest resort expansion in Walt Disney World history, resulting in double-digit percentage revenue growth, seven consecutive years of record revenues and higher profits. He began his career at Disney as a teenager in cash control. Mr. Weiss serves on the Alticor (Amway) Board of Directors and the Diamond Resorts International Board of Directors. He previously served on the Metro Orlando Economic Development Commission Governor’s Council, was a National Board Member of the Sanford-Burnham Medical Research Institute and was appointed by the U.S. Commerce Secretary as a founding member to the Corporation for Travel Promotion Board of Directors. Mr. Weiss earned a bachelor’s degree from the University of Central Florida and an MBA from Rollins College.

Dan W. Reicher is our Senior Climate Advisor. He has over 35 years of industry experience as an entrepreneur, policymaker, lawyer and educator focused on clean energy and climate change. Mr. Reicher has served three U.S. presidents, testified before the U.S. Congress more than 50 times, led the launch of Google’s groundbreaking climate and clean energy work, oversaw a \$1.2 billion annual clean energy R&D budget as U.S. Assistant Secretary of Energy, and co-founded the nation’s first investment firm focused exclusively on renewable energy project finance. He is currently a Partner in the Climate Adaptive Infrastructure Fund, a sustainable energy/water/transportation infrastructure investment firm and also Senior Research Scholar at Stanford University’s Woods Institute for the Environment, a hub for interdisciplinary environmental and sustainability research. Mr. Reicher also serves as a Board Member of the Interstate Renewable Energy Council and American Rivers. Mr. Reicher holds a B.A. in biology from Dartmouth College and a J.D. from Stanford Law School and also studied at Harvard’s Kennedy School of Government and MIT.

Audit Committee

Our Audit Committee has been established in accordance with Section 3(a)(58)(A) of the Exchange Act and consists of Mr. Jonas Grossman, Mr. Brendan Riley and Ms. Britt Ide, each of whom is an independent director and is “financially literate” as defined under the Nasdaq listing standards. Our Board has determined that Mr. Grossman, chairman of our Audit Committee, qualifies as an “audit committee financial expert,” as defined under rules and regulations of the SEC.

The audit committee’s duties, which are specified in our Audit Committee Charter, include, but are not limited to:

- reviewing and discussing with management and the independent auditor the annual audited financial statements, and recommending to the board whether the audited financial statements should be included in our Form 10-K;

[Table of Contents](#)

- discussing with management and the independent auditor significant financial reporting issues and judgments made in connection with the preparation of our financial statements;
- discussing with management major risk assessment and risk management policies;
- monitoring the independence of the independent auditor;
- verifying the rotation of the lead (or coordinating) audit partner having primary responsibility for the audit and the audit partner responsible for reviewing the audit as required by law;
- reviewing and approving all related-party transactions;
- inquiring and discussing with management our compliance with applicable laws and regulations;
- pre-approving all audit services and permitted non-audit services to be performed by our independent auditor, including the fees and terms of the services to be performed;
- appointing or replacing the independent auditor;
- determining the compensation and oversight of the work of the independent auditor (including resolution of disagreements between management and the independent auditor regarding financial reporting) for the purpose of preparing or issuing an audit report or related work;
- establishing procedures for the receipt, retention and treatment of complaints received by us regarding accounting, internal accounting controls or reports which raise material issues regarding our financial statements or accounting policies; and
- approving reimbursement of expenses incurred by our management team in identifying potential target businesses.

Compensation Committee

Our Compensation Committee consists of Mr. Douglas Cole and Mr. Jon Najarian, each of whom is an independent director. Mr. Cole is the chairman of our Compensation Committee. We adopted a Compensation Committee charter, which details the principal functions of the compensation committee, including:

- reviewing and approving on an annual basis the corporate goals and objectives relevant to our Chief Executive Officer's compensation, evaluating our Chief Executive Officer's performance in light of such goals and objectives and determining and approving the remuneration (if any) of our Chief Executive Officer based on such evaluation;
- reviewing and approving the compensation of all of our other executive officers;
- reviewing our executive compensation policies and plans;
- implementing and administering our incentive compensation equity-based remuneration plans;
- assisting management in complying with our proxy statement and annual report disclosure requirements;
- approving all special perquisites, special cash payments and other special compensation and benefit arrangements for our executive officers and employees;
- if required, producing a report on executive compensation to be included in our annual proxy statement; and
- reviewing, evaluating and recommending changes, if appropriate, to the remuneration for directors.

The charter provides that the compensation committee may, in its sole discretion, retain or obtain the advice of a compensation consultant, legal counsel or other adviser and will be directly responsible for the appointment, compensation and oversight of the work of any such adviser. However, before engaging or receiving advice from a compensation consultant, external legal counsel or any other adviser, the compensation committee will consider the independence of each such adviser, including the factors required by Nasdaq and the SEC.

Nominating and Corporate Governance Committee

Our Nominating and Corporate Governance Committee consists of Mr. Douglas Cole and Mr. Jon Najarian, each of whom is an independent director under Nasdaq's listing standards. Mr. Cole is the Chairperson of the Nominating and Corporate Governance Committee. The Nominating and Corporate Governance Committee is responsible for overseeing the selection of persons to be nominated to serve on our board of directors. The Nominating and Corporate Governance Committee considers persons identified by its members, management, stockholders, investment bankers and others.

The guidelines for selecting nominees, which are specified in CLAQ's Nominating and Corporate Governance Committee Charter, generally provide that persons to be nominated:

- should have demonstrated notable or significant achievements in business, education or public service;
- should possess the requisite intelligence, education and experience to make a significant contribution to the board of directors and bring a range of skills, diverse perspectives and backgrounds to its deliberations; and
- should have the highest ethical standards, a strong sense of professionalism and intense dedication to serving the interests of the stockholders.

The Nominating and Corporate Governance Committee will consider a number of qualifications relating to management and leadership experience, background and integrity and professionalism in evaluating a person's candidacy for membership on the board of directors. The Nominating and Corporate Governance Committee may require certain skills or attributes, such as financial or accounting experience, to meet specific board needs that arise from time to time and will also consider the overall experience and makeup of its members to obtain a broad and diverse mix of board members. The Nominating and Corporate Governance Committee does not distinguish among nominees recommended by stockholders and other persons.

Employment Agreements

CLAQ has not entered into any employment agreements with its executive officers, and has not made any agreements to provide benefits upon termination of employment.

Executive Officers and Director Compensation

No executive officer has received any cash compensation for services rendered to us. Commencing on July 14, 2021 through the completion of our initial business combination with a target business, we pay Chardan Capital Markets, LLC, an affiliate of CleanTech Investments, a fee of \$10,000 per month for providing us with office space and certain office and secretarial services. However, pursuant to the terms of such agreement, we may delay payment of such monthly fee upon a determination by our audit committee that we lack sufficient funds held outside the trust to pay actual or anticipated expenses in connection with our initial business combination. Any such unpaid amount will accrue without interest and be due and payable no later than the date of the consummation of our initial business combination. No compensation or fees of any kind, including finder's fees, consulting fees and other similar fees, will be paid to our insiders or any of the members of our management team, for services rendered prior to or in connection with the consummation of our initial business combination (regardless of the type of transaction that it is). However, such individuals will receive reimbursement for any out-of-pocket expenses incurred by them in connection with activities on our behalf, such as identifying potential target businesses, performing business due diligence on suitable target businesses and business combinations as well as traveling to and from the offices, plants or similar locations of prospective target businesses to examine their operations. There is no limit on the amount of out-of-pocket expenses reimbursable by us; provided, however, that to the extent such expenses exceed the available proceeds not deposited in the trust account and the interest income earned on the amounts held in the trust account, such expenses would not be reimbursed by us unless we consummate an initial business combination.

After our initial business combination, members of our management team who remain with us may be paid consulting, management or other fees from the combined company with any and all amounts being fully disclosed to stockholders, to the extent then known, in the proxy solicitation materials furnished to our stockholders. It will be up to the directors of the post-combination business to determine executive and director compensation.

DIRECTORS AND EXECUTIVE OFFICERS OF NAUTICUS**Current Directors and Executive Officers**

References in this section to “we”, “our”, “us”, the “Company”, “Nauticus Robotics”, or “Nauticus” generally refer to Nauticus and its consolidated subsidiaries.

The names, ages, and current positions of Nauticus’ current directors and executive officers are listed in the table below. Nauticus expects that some of these executive officers and directors will continue as executive officers and directors of Pubco following the Business Combination.

Name	Age	Position
Nicolaus Radford	44	Co-Founder, Chief Executive Officer and Chairman
Reginald B. Berka	66	Co-Founder, Chief Operations Officer and Director
Todd Newell	52	Senior Vice President of Business Development
Arindam Bhattacharya	50	Director
Roderick Mackenzie	46	Director

Nicolaus A. Radford. Nicolaus A. Radford is the Co-Founder, Chief Executive Officer and Chairman of Nauticus. Mr. Radford co-founded Nauticus Robotics and joined the company in 2014. Mr. Radford has been continuously employed at Nauticus since its inception in 2014. Prior to that, Mr. Radford led NASA’s humanoid robotics efforts for both Space Station and future Mars missions, including both Valkyrie and Robonaut. Additionally, he was also the principal investigator (“*PI*”) for NASA in the Defense Advanced Research Projects Agency’s (“*DARPA*”) advanced electric machine research for robotics. Mr. Radford led NASA’s efforts in exoskeleton research for the International Space Station (“*ISS*”) crew exercise and mobility assistance and initially served as Co-PI for NASA on DARPA’s Warrior Web program, which focused on wearable robotics for military applications. He has extensive experience leading multidisciplinary teams in challenging development timeline environments. During Mr. Radford’s tenure at NASA, he was the recipient of numerous patents, design awards, and commendations for his expertise and leadership that ultimately culminated in him receiving NASA’s Outstanding Leadership Medal. He has been published several times on a multitude of topics relating to spaceflight robotics and contributed to Springer’s Humanoid Robotics Handbook. Mr. Radford earned his B.S. and M.S. from Purdue University in Electrical and Computer Engineering.

Reginald B. Berka. Dr. Berka is Co-Founder, Chief Operations Officer and Director of Nauticus. Dr. Berka joined Nauticus Robotics on a fulltime basis in 2016. Mr. Berka has been continuously employed by Nauticus since 2016 as Chief Operating Officer. As of April 4, 2022 Dr. Berka will no longer serve as Chief Operating Officer of Nauticus but will instead continue at Nauticus as Executive Vice President of Business Operations in order to assist with the transition and closing matters. Prior to joining Nauticus, he served as chief of the Robotic Systems Technology Branch at the National Aeronautics and Space Administration’s (NASA) Johnson Space Center. Prior to his recent tenure at NASA, Dr. Berka served as president of Aphelion, Inc., where he developed the startup business into a global leader in electronic payments for the health and fitness market. He guided the company from startup through an acquisition by CheckFree, Inc. of Atlanta, Georgia and became vice-president, general manager of the resulting business unit. While at Aphelion, the company received the Crescent Technology Fast 50 award in recognition of the top 50 technology companies in Texas by Deloitte and Touche. Dr. Berka earned his Ph.D. in mechanical engineering from Rice University and holds a BSME from Wichita State University. In addition to his current work with Nauticus, Dr. Berka teaches engineering management coursework at the University of Houston-Clear Lake.

Todd Newell. Todd Newell is the Senior Vice President of Business Development of Nauticus since June 2020. Previously, Mr. Newell was employed for 13 years by Oceaneering and last served as its VP for Technology and Business Development from May 2007 to March 2020. He has enjoyed a career that has taken him from being a contributing engineer for industrial automation and robotics to executive levels of engineering and business development leadership with worldwide responsibilities. For over a decade, Mr. Newell has been focused on developing and commercializing Offshore Technologies and he joined Nauticus this past year to lead the commercialization efforts. Mr. Newell earned his bachelor’s degree from Tennessee Technological University in Mechanical Engineering with extended studies within Business Strategy & Strategy Execution.

Arindam Bhattacharya. Arindam Bhattacharya is a director on Nauticus' board. Mr. Bhattacharya has been serving as managing director for Schlumberger New Energy Venture, a corporate venture capital arm of the U.S.-based oil services provider, since August 2020 where he identifies energy transition opportunities for the Schlumberger firm. From September 2019 to August 2020, Mr. Bhattacharya served as Corporate Vice-President of Strategy, Marketing & Technology at the Reservoir & Infrastructure Group. From September 2015 to August 2019, he served as Product Line President at Schlumberger Land Rigs. In total, he has spent more than 25 years at Schlumberger in various roles. Mr. Bhattacharya also serves on various boards, including CelluForce, a nanocrystalline cellulose producer, Molyworks, a shippable metallurgical system developer, BISN, a downhole gas-tight seal creator, the Arabian Drilling Company (ADC), a Schlumberger/TAQA joint venture in Saudi Arabia, and NeoRig, a Schlumberger/Bauer Maschinen joint venture. Mr. Bhattacharya received his bachelor's degree in electrical engineering from the Indian Institute of Technology and his master's degree in petroleum engineering and project management from Heriot Watt University.

Roderick Mackenzie. Roderick Mackenzie is a director on Nauticus' board. Mr. Mackenzie has over 20 years of experience in the offshore drilling industry, prior to his time in marketing. He has worked on all manner of drilling rigs in Algeria, Nigeria, Cameroon, Angola, Brazil, and the U.S. Gulf of Mexico. His tenure with Transocean spans over 12 years in positions of increasing responsibility. Since February 2022, he has served as Executive Vice President and Chief Commercial Officer of Transocean. From August 2018 to February 2022, he served as Senior Vice President of Marketing, Innovation, and Industry Relations at Transocean. From February 2017 to July 2018, he served as Vice President of Marketing and Contracts at Transocean. Mr. Mackenzie earned his Bachelor of Engineering from the University of Strathclyde and subsequently completed Harvard Business School's Advanced Management Program for business leadership.

Compensation of Executive Officers

This section provides an overview of the Company's executive compensation programs, including a narrative description of the material factors necessary to understand the information disclosed in the summary compensation table below.

For the year ended December 31, 2021, the Company's named executive officers ("Named Executive Officers" or "NEOs") were:

- Nicolaus Radford, Co-Founder, Chief Executive Officer and Chairman;
- Reginald B. Berka, Co-Founder, Chief Operations Officer and Director; and
- Todd Newell, Senior Vice President of Business Development

The objective of the Company's compensation program is to provide a total compensation package to each NEO that will enable the Company to attract, motivate and retain outstanding individuals, align the interests of our executive team with those of our stockholders, encourage individual and collective contributions to the successful execution of our short- and long-term business strategies and reward NEOs for performance. The board of directors of the Company has historically determined the compensation for the NEOs.

For 2021, the compensation program for the NEOs consisted of base salary and incentive compensation delivered in the form of a discretionary annual bonus and time-based stock option awards, each as described below:

- **Base Salary.** Base salary is paid to attract and retain qualified talent and is set at a level that is commensurate with the executive's duties and authorities, contributions, prior experience and sustained performance.
- **Annual Bonus.** Pursuant to Mr. Newell's offer letter, dated June 12, 2020 (the "Newell Offer Letter"), Mr. Newell is eligible to receive a bonus at the discretion of the Company's Board of Directors. In 2021, Mr. Newell was awarded a discretionary bonus in the amount of \$10,000.

- Stock Option Awards.** On December 16, 2021, Messrs. Radford and Berka received stock option awards pursuant to our 2015 Equity Incentive Plan. Pursuant to the Newell Offer Letter, Mr. Newell received a stock option award on September 1, 2021 pursuant to our 2015 Equity Incentive Plan. All of the stock options noted herein are time-based and 25% of these stock options vest on the first anniversary of the applicable grant date and the remaining 75% of these stock options vest in thirty-six (36) successive equal monthly installments measured from the first anniversary of the grant date, subject to continued service with the Company through each such vesting date. No stock option is exercisable more than 10 years after the grant date. As more fully described in the section entitled “*Proposal 1 — The Business Combination Proposal — Treatment of Nauticus Securities*” beginning on page 96, at the Effective Time, these stock options will be assumed by CLAQ and converted automatically into an option to purchase shares of the CLAQ’s Common Stock (see “*Proposal 1 — The Business Combination Proposal — Treatment of Nauticus Securities — Stock Options*” for additional information, including the conversion calculation.

2021 Summary Compensation Table

The following table shows information concerning the annual compensation for services provided to the Company by our NEOs for the year ended December 31, 2021.

Name and Position	Year	Salary (\$)	Bonus (\$)	Option Awards (\$) ⁽¹⁾	All Other Compensation (\$) ⁽²⁾	Total (\$)
Nicolaus Radford <i>Co-Founder, Chief Executive Officer and Chairman</i>	2021	250,000	—	688,412	18,075.56	956,487.56
Reginald B. Berka <i>Co-Founder, Chief Operations Officer and Director</i>	2021	250,000	—	91,065	18,075.56	359,140.56
Todd Newell <i>Senior Vice President of Business Development</i>	2021	225,000	10,000	278,802	6,750.04	520,552.04

- The amounts in this column represent the aggregate grant date fair value of option awards granted to each NEO, computed in accordance with FASB ASC Topic 718. See the section entitled “*Management’s Discussion and Analysis of Financial Condition and Results of Operations of Nauticus — Critical Accounting Policies and Estimates — Stock-Based Compensation*” for a discussion of assumptions made by us in determining the grant date fair value of our equity awards.
- The amounts in this column for Messrs. Radford and Berka represent 401(k) plan safe harbor contributions and automobile and cellphone allowance. The amounts in this column for Mr. Newell represent 401(k) safe harbor contributions.

Narrative Disclosure to Summary Compensation Table

Employee Benefits

Our NEOs are generally eligible to participate in our health and welfare, retirement and other employee benefit programs on the same basis as other employees, subject to applicable law. We maintain a 401(k) plan for eligible employees. Under the 401(k) plan, eligible employees may elect to contribute a portion of their eligible compensation as pre-tax or Roth deferrals in accordance with the limitations imposed under the Internal Revenue Code of 1986, as amended (the “Code”). We provide a safe harbor contribution in an amount not less than 3% of each participant’s eligible compensation, subject to limitations imposed under the Code. We may also make discretionary matching and profit-sharing contributions.

Employment Agreements

Existing Employment Agreements

Mr. Radford is a party to an employment agreement with the Company, dated August 28, 2015 (the “Existing Radford Employment Agreement”), pursuant to which he is employed on an at-will basis and which provides that he is to be compensated with an annual base salary. Under the Existing Radford Employment Agreement, Mr. Radford is not eligible to receive any severance payments in the event of termination of Mr. Radford’s employment.

Mr. Berka is a party to an employment agreement with the Company, dated April 25, 2016 (the “Existing Berka Employment Agreement”), pursuant to which he is employed on an at-will basis and which provides that he is to be compensated with an annual base salary. Under the Existing Berka Employment Agreement, Mr. Berka is not eligible to receive any severance payments in the event of termination of Mr. Berka’s employment.

Mr. Newell is party to an employment agreement with the Company, dated June 22, 2020 (the “Existing Newell Employment Agreement”), pursuant to which he is employed on an at-will basis and which provides that he is to be compensated with an annual base salary. Under the Existing Newell Employment Agreement, Mr. Newell is not eligible to receive any severance payments in the event of termination of Mr. Newell’s employment. In addition to the stock option grants outlined above in the section titled “Stock Option Awards” of this *Directors and Executive Officers of Nauticus* section, Newell’s Offer Letter provides for a discretionary bonus.

New Employment Agreement

The Company entered into an employment agreement with Mr. Radford, dated December 16, 2021, which will become effective upon the closing of the Business Combination (the “New Radford Employment Agreement”). Under the New Radford Employment Agreement, Mr. Radford will serve as the Combined Company’s Chief Executive Officer. The New Radford Employment Agreement provides for an annual base salary of \$375,000 and target annual bonus opportunity equal to 75% of Mr. Radford’s then-current annual base salary, subject to the achievement of certain performance goals set by the board of directors, the board of directors’ assessment of achievement of those goals and the terms and conditions of the bonus plan to be approved by the board of directors. The New Radford Employment Agreement also provides that Mr. Radford is entitled to receive an annual grant of incentive equity awards pursuant to any plans or arrangements the Combined Company may have in effect from time to time subject to the discretion of the board of directors. Additionally, pursuant to the terms of the New Radford Employment Agreement, Mr. Radford is entitled to receive a one-time cash bonus equal to \$1,000,000 following the closing of the Business Combination.

In the event that Mr. Radford’s employment is terminated without cause or Mr. Radford resigns for good reason following the closing of the Business Combination other than in connection with a change in control, he is eligible to receive (i) continued salary payments and COBRA premiums for twelve months following his termination of employment or resignation; and (ii) payment of his annual bonus for the fiscal year immediately preceding the year in which he is terminated or resigns to the extent such annual bonus is unpaid. In the event that Mr. Radford’s employment is terminated without cause or Mr. Radford resigns for good reason following the closing of the Business Combination and within three months prior to a change in control or within twelve months following a change in control, he is eligible to receive (i) continued salary payments and COBRA premiums for eighteen months following his termination of employment or resignation; (ii) payment of his annual bonus for the fiscal year immediately preceding the year in which he is terminated or resigns, to the extent such annual bonus is unpaid; (iii) a lump-sum payment equal to 100% of the higher of (1) his annual bonus as in effect for the fiscal year in which the change in control occurs or (2) his bonus as in effect for the fiscal year in which his termination of employment occurs; and (iv) acceleration of 100% of his outstanding unvested equity awards on the date of his termination (if however, an outstanding equity award is to vest and/or the amount of the equity award to vest is to be determined based on the achievement of performance criteria, then the equity award will vest as to one hundred percent (100%) of the amount of the equity award assuming the performance criteria had been achieved at target levels for the relevant performance period(s), unless otherwise provided in the applicable award agreement).

Outstanding Equity Awards at 2021 Fiscal Year-End

The following table shows information regarding outstanding equity awards held by the NEOs as of December 31, 2021.

Name	Option Awards				
	Number of Securities Underlying Unexercised Options Exercisable (#)	Number of Securities Underlying Unexercised Options Unexercisable (#) ⁽¹⁾	Equity Incentive Plan Awards: Number of Securities Underlying Unexercised Unearned Options (#)	Option Exercise Price (\$)	Option Expiration Date
Nicolaus Radford ⁽²⁾	—	37,798	—	35.52	December 16, 2031
Reginald B. Berka ⁽³⁾	—	5,000	—	35.52	December 16, 2031
Todd Newell ⁽⁴⁾	—	20,000	—	27.57	September 1, 2031

- (1) 25% of these stock options vest on the first anniversary of the applicable grant date and the remaining 75% of these stock options vest in thirty-six (36) successive equal monthly installments measured from the first anniversary of the grant date, subject to continued service with the Company through each such vesting date. No stock option is exercisable more than 10 years after the grant date.
- (2) Granted on December 16, 2021.
- (3) Granted on December 16, 2021.
- (4) Granted on September 1, 2021.

Director Compensation

None of the Company's non-employee directors have received any compensation for services rendered to the Company for 2021.

**DIRECTORS AND EXECUTIVE OFFICERS OF THE COMBINED COMPANY
AFTER THE BUSINESS COMBINATION**

Information about Directors Expected to be Appointed to the Board Upon the Closing of the Merger

Upon consummation of the Merger, the Combined Company's Board of Directors will comprise 8 members. Each of CLAQ's incumbent directors, with the exception of Mr. Eli Spiro will resign from our Board upon Closing.

Executive Officers and Directors

The following persons are anticipated to be the executive officers and directors of the Combined Company, which will be renamed "Nauticus Robotics, Inc." following the Merger:

Name	Age	Position
Nicolaus Radford	44	Co-Founder, Chief Executive Officer and Director
Donnelly A. Bohan	49	Chief Operating Officer
Rangan Padmanabhan	47	Chief Financial Officer
M. Dilshad Kasmani	44	General Counsel
Mark Mey	58	Director
Lisa Porter	54	Director
Jim Bellingham	60	Director
Adam Sharkawy	57	Director
John W. Gibson, Jr.	64	Director
Joseph W. Dyer	75	Director
Eli Spiro	50	Director

Nicolaus A. Radford. Nicolaus A. Radford is the Co-Founder, Chief Executive Officer and Chairman of Nauticus. For more information about Mr. Radford, see "Directors and Executive Officers of Nauticus."

Donnelly A. Bohan. Donnelly Bohan has served as Nauticus' Chief Operating Officer since April 2022. Prior to joining Nauticus, Ms. Bohan served as Vice President, Division Manager for the Mission Operations and Infrastructure Protection Division at Leidos, Inc. ("Leidos"), where she oversaw the day-to-day operations of a \$340 million and 850 plus person line organization providing electronic and integrated security systems for base defense, access control, and counter-small unmanned aerial systems. From December 2016 to February 2021, Ms. Bohan served as Vice President, Division Manager for the Maritime Systems Division at Leidos, where she oversaw day-to-day operations of a \$185 million and 500 person team focused on autonomous surface and subsurface solutions; advanced system architecture; sensor design; integration, and other capabilities that help global customers meet mission imperatives. From June 2016 to December 2016, Ms. Bohan worked directly with the Executive Vice President of Business Development and Strategy, focused on the corporate strategic vision for Leidos with an emphasis on our global presence, products, and M&A. From 2015 to June 2016, Ms. Bohan served as Vice President, Deputy Operations Manager for the Missions Systems Integration Operation (MSIO) at Leidos.

Ms. Bohan earned a Bachelor of Science in Community Health, Health Planning and Administration from the University of Illinois at Urbana-Champaign in 1995. She also earned an MBA from R.H. Smith School of Business from the University of Maryland at College Park in 2009.

Rangan Padmanabhan. Rangan Padmanabhan has served as Nauticus' Chief Financial Officer since May 2022. Prior to his role at Nauticus, Mr. Padmanabhan served as the co-founder and as the Chief Financial Officer of Rad Capital Ventures LLC, the management company of a hedge fund involved in the trading of fixed transmission rights in North American electricity markets, from May 2020 to May 2022. During his time at Rad Capital Ventures LLC, Mr. Padmanabhan oversaw the accounting, regulatory and audit functions of the fund while maintaining investor relations and communications with dozens of the fund's accredited investors, corporate investors, and family offices.

Since December 2020, Mr. Padmanabhan also has served as a consultant at Veritas Total Solutions, where he is a risk management subject expert for the implementation of the Quant Portal at Shell Oil Company. From October 2021 to December 2021, Mr. Padmanabhan served as a consultant at Houston Mechatronics, Inc., where he

built and validated forecasting models and financial statement summaries. From January 2014 to December 2019, Mr. Padmanabhan served as Managing Partner at Solaris Asset Management, Inc., where he managed a multi-strategy hedge fund.

In addition, Mr. Padmanabhan has vast public company experience through his various previously held roles at, including but not limited to, (i) Duke Energy, (ii) Sonat Inc. (subsequently acquired by El Paso Corporation and Kinder Morgan, Inc.), (iii) FPL Group, Inc. (rebranded as NextEra Energy Inc.), and (iv) CMS Energy Corporation.

Mr. Padmanabhan graduated Magna Cum Laude from Rice University with a degree in Economics and Management. He attained the Financial Risk Manager (FRM) certification in 1998 and received the Chartered Financial Analyst (CFA) charter in 2001. Mr. Padmanabhan is a frequent guest lecturer for graduate classes at Rice University on various topics pertaining to capital markets. He also serves on the Advisory Board of the Center for Computational Finance and Economic Systems (CoFES) at Rice University.

M. Dilshad Kasmani. M. Dilshad Kasmani has served as Nauticus' General Counsel and Corporate Secretary since April 2022. Before joining Nauticus, Mr. Kasmani served as President of ManifestSeven Holdings Corporation from June 2020 to April 2022 and its Chief Legal Officer from September 2019 to April 2022. Mr. Kasmani served as Associate General Counsel and Assistant Secretary of the general partner of American Midstream Partners, LP from November 2018 to September 2019. Mr. Kasmani served as Associate General Counsel and Company Secretary of Cardtronics plc from May 2016 to February 2018, and Associate General Counsel and Assistant Secretary of its predecessor, Cardtronics, Inc., from January 2014 to May 2016. Mr. Kasmani began his legal career as an attorney for Andrews Kurth LLP and then Paul Hastings LLP, representing clients on various corporate, capital markets, private equity, and other transactional matters.

Before his legal career, Mr. Kasmani held various local and state government positions between August 1997 and October 2006, ending as the Chief Economist and Deputy Tax Assessor-Collector of Harris County, Texas. Mr. Kasmani has served in the U.S. Navy Reserves since October 2003 and currently holds the rank of Commander. Mr. Kasmani earned a Bachelor of Arts in Economics and Political Science in 1999 and a Master of Arts in Economics in 2003 from the University of Houston. He also earned a Doctor in Jurisprudence from the South Texas College of Law in 2007.

Mark Mey. Mark Mey currently serves as the CFO of Transocean which he joined in May 2015. He previously served as Executive Vice President and Chief Financial Officer of Atwood Oceanics ("Atwood") from August 2010 to May 2015. Including his almost five years at Atwood, he has over 28 years of experience in the energy and financial services industries in both the United States and South Africa. Prior to Atwood, from August 2005 to July 2010 Mr. Mey was Senior Vice President, Chief Financial Officer, and a Director of Scorpion Offshore Ltd. He also held positions of increasing responsibility from February 1994 to August 2005 during his 12 years with offshore driller Noble Corporation, including Vice President and Treasurer. He served on the Board of Directors of Transocean Partners LLC from June 2015 to December 2016.

Mr. Mey earned an Advanced Diploma in Accounting and a Bachelor of Commerce degree from the University of Port Elizabeth, South Africa. He is a Chartered Accountant and attended the Harvard Business School Executive Advanced Management Program.

Lisa Porter. Lisa Porter is the Co-Founder and Co-President of LogiQ, Inc., a company providing high-end management, scientific, and technical consulting services, which she co-founded in July 2020. She was previously the Deputy Under Secretary of Defense for Research and Engineering from October 2018 to July 2020, and in that role, she shared responsibility with the Under Secretary for the research, development, and prototyping activities across the Department of Defense.

In prior roles she served as Executive Vice President of In-Q-Tel (IQT) and Director of IQT Labs from April 2017 to September 2018, Director of Lab41 and Executive Vice President and Director of CosmiQ Works from October 2015 to March 2017, the President of Teledyne Scientific & Imaging from July 2013 to September 2015, the first Director of the Intelligence Advanced Research Projects Activity (IARPA) in the Office of the Director of National Intelligence (ODNI) from February 2008 to May 2012, the Associate Administrator for the Aeronautics Research Mission Directorate at NASA from October 2005 to January 2008, and as a program manager and senior scientist at the Defense Advanced Research Projects Agency (DARPA) from April 2002 to July 2005.

She holds a bachelor's degree in nuclear engineering from the Massachusetts Institute of Technology and a doctorate in applied physics from Stanford University. She received the Office of the Secretary of Defense Medal for Exceptional Public Service, the NASA Outstanding Leadership Medal, the National Intelligence Distinguished Service Medal, the Presidential Meritorious Rank Award, and the Department of Defense Medal for Distinguished Public Service.

Jim Bellingham. Mr. Bellingham concurrently serves as a research professor in the Whiting School's Department of Mechanical Engineering and as a senior advisor in APL's Asymmetric Operations Sector. He joined Johns Hopkins from the Woods Hole Oceanographic Institution (WHOI) where he was founding Director of the Consortium for Marine Robotics since 2014. There, he led a range of initiatives to advance robotics innovations working with regional, national and global partners; these included creating the DunkWorks advanced design and prototyping center, revitalizing the Pressure Test Facility, and initiating the Arctic Long - Range AUV program focused on oil-spill response. Under his direction, the Consortium organized a range of high-impact initiatives including the Ocean Worlds Catalyst Program, which teams with NASA's Jet Propulsion Laboratory to develop the science and technology for exploring oceans on other worlds, and the successful Marine Robotics Entrepreneurship Forum that fostered a range of programs including US Department of Energy-funded aquaculture activities.

Bellingham serves on a number of institutional boards and advisory boards including Science Robotics, American Association for the Advancement of Science; the Naval Studies Board, National Academies of Sciences Engineering Medicine; OceanX, Dalio Philanthropies; the Institute of Marine Research, Norway; and MARUM Center for Marine Environmental Sciences, University of Bremen, Germany. He has served on the Naval Research Advisory Committee including as chair, and on Secretary of the Navy Advisory Panel and several National Academies studies.

His honors include election to the National Academy of Engineering (induction October 2021), the Navy Superior Public Service Award, and the Lockheed Martin Award for Ocean Science and Engineering. Mr. Bellingham has authored dozens of scholarly papers. He received a B.S., an M.S., and a Ph.D., in physics from the Massachusetts Institute of Technology.

Adam Sharkawy. Adam Sharkawy has been a Founder and Managing Partner at Material Impact, a unique venture fund that focuses on investing in and building successful companies with novel products based on innovations in the underlying material, hardware, and manufactured goods technologies, since January 2016. He additionally serves as member of the Board of Directors for 11 companies including Soft Robotics, Inc, Orbion Space Technologies, 6K, LynQ, NextGen Jane, BloomerTech, Nohbo and JumpAero.

Mr. Sharkawy has held a series of executive operating roles in publicly traded healthcare companies. These include Sr. Vice President of the Medicines Company and Head of their Surgery and Perioperative Care Global Business Unit, where he led the integration of four acquisitions along with a legacy fifth business into a global unit with products spanning the spectrum of acute surgical care.

Prior to his large corporate roles, Mr. Sharkawy was an entrepreneur. He helped start Ventrica, Inc., a privately held medical device company until the acquisition of its technology by Medtronic. While at Ventrica, he also spun off a new venture in collaboration with the German government, Ventrigrift, GMBH. Prior to that, Mr. Sharkawy served in several technology development roles for Heartport (acquired by Johnson and Johnson) and Advanced Cardiovascular Systems (acquired by Eli Lilly) and then spun out as publicly traded Guidant. Mr. Sharkawy has also been a consultant to or on the Advisory Board of companies spanning industries such as aerospace, oil & gas, battery, and medical device.

Mr. Sharkawy received his Ph.D. from Duke University in Biomaterials / Biomedical Engineering. He also holds a Masters Degree from Texas A&M University from the Institute of Innovation and Design in Engineering. Adam received his Bachelor of Science in Mechanical Engineering from the American University, Cairo and before that, studied pre-medicine and Biology at the Honors Program at the University of Delaware. He is a scientific inventor and holds 23 issued U.S. patents and numerous international patents.

John W. Gibson, Jr. Mr. Gibson has served as Chairman of the Board of Directors, Chief Executive Officer, and President of Flotek Industries since January 2020. John is a recognized leader with more than 35 years of global experience in the energy technology, oil and gas services and exploration and production sectors of the energy industry. John also currently serves as a member of the Nauticus Robotics Advisory Board, as well as Director of Bluware Inc.

[Table of Contents](#)

Prior to Flotek, Mr. Gibson served as Chairman of Energy Technology, from May 2017 to December 2019, at Tudor, Pickering, Holt & Company (“TPH”), an energy-focused investment bank headquartered in Houston. In this role, he led a team focused on opportunities in emerging oil and gas technologies. Prior to TPH, Mr. Gibson served as President and Chief Executive Officer of Tervita Corporation (“Tervita”), a major Canadian-based environmental and oilfield services company. Prior to Tervita, he was President and Chief Executive Officer of Paradigm Geophysical and Landmark Graphics Corporation, as well as President of Halliburton Company’s Energy Services Group. Mr. Gibson also served as the former head of subsurface research at Chevron Corporation.

Mr. Gibson also served as President and Chief Executive Officer of Tervita Corporation from July 2010 to May 2015, where he successfully executed a \$2.6 billion debt restructuring, coincident with an aggressive growth and diversification strategy.

He is currently a member of University of Texas at Austin’s Bureau of Economic Geology Visiting Committee, a member of the Advisory Board of Montrose Lane and a director of the National Board of KickStart for Kids. Mr. Gibson also serves as the Honorary Consulate for Kazakhstan for the State of Texas.

He holds a Bachelor of Science in Geology from Auburn University and Master of Science in Geology from the University of Houston.

Joseph W. Dyer. Joseph W. Dyer has served a consultant in the technology, aerospace, and defense markets since 2013. John operates at the intersection of technology, finance, and risk management. He participated in the Congressionally directed “Space Force” study and the NDAA Section 809 Commission on Acquisition Streamlining. Prior to his consultant roles, John chaired NASA’s Aerospace Safety and Advisory Panel for almost 13 years. At the NASA’s Aerospace Safety and Advisory Panel, he was significantly engaged in the development of commercial space companies.

From 2003 through 2013, Mr. Dyer was President, Chief Operating Officer, and Chief Strategy Officer of the Business Unit at iRobot Corp. He transitioned to iRobot from a career in the U.S. Navy where his last assignment was as the three-star Commander of the Naval Air Systems Command (“NAVAIR”). At NAVAIR, he was responsible for contracting, researching, developing, testing and evaluating, engineering and overseeing logistics for naval aircraft, unmanned systems, air launched weapons, electronic warfare, as well as tactical and Intelligence, Surveillance, and Reconnaissance (“ISR”) sensors. He was the U.S. Navy’s senior, uniformed acquisition/procurement official. His naval career also included positions as naval aviation’s chief engineer, Commander of the Naval Air Warfare Center, Aircraft Division, and F/A-18 program manager.

As recognition for his outstanding engineering achievement in aerospace, Mr. Dyer received the James H. Doolittle award. Joseph is also an elected fellow in the Society of Experimental Test Pilots and the National Academy of Public Administration. Mr. Dyer holds a bachelor’s degree in chemical engineering from North Carolina State University and a master’s degree in finance from the Naval Postgraduate School in Monterey, California.

Eli Spiro. Eli Spiro is the Chief Executive Officer of CLAQ and will be a member of the Combined Company’s Board of Directors. For more information about Mr. Spiro, see “*Directors and Officers of CleanTech.*”

Family Relationships

Nauticus’ Co-Founder and Executive Vice President of Business Operations, Reginald B. Berka, is married to Nauticus’ Vice President of Finance, Angela Berka.

Board of Directors

Director Independence

Nasdaq listing rules require that a majority of the board of directors of a company listed on Nasdaq be composed of “independent directors,” which is defined generally as a person other than an officer or employee of the company or its subsidiaries or any other individual having a relationship, which, in the opinion of the company’s board of directors, would interfere with the director’s exercise of independent judgment in carrying out the responsibilities of a director. The Combined Company’s Board of Directors has determined that, upon the consummation of the Merger, each of _____, _____, and _____ will be an independent director under the Nasdaq listing rules and Rule 10A-3 of the Exchange Act. In making these determinations, the Combined Company’s Board of Directors considered the

[Table of Contents](#)

current and prior relationships that each non-employee director has with Nauticus and will have with the combined company and all other facts and circumstances the Combined Company's Board of Directors deemed relevant in determining independence, including the beneficial ownership of our common stock by each non-employee director, and the transactions involving them described in the section entitled "*Certain Relationships and Related Transactions*."

Committees of the Board of Directors

The standing committees of Combined Company's Board of Directors will consist of an Audit Committee, a Compensation Committee, and a Nominating and Corporate Governance Committee. The expected composition of each committee following the Merger is set forth below.

Audit Committee

Our Audit Committee has been established in accordance with Section 3(a)(58)(A) of the Exchange Act and following the merger will consist of _____, _____ and _____, each of whom are independent directors and are "financially literate" as defined under the Nasdaq listing standards. _____ will serve as chairman of the Audit Committee. Our Board has determined that _____ qualifies as an "audit committee financial expert," as defined under rules and regulations of the SEC.

The audit committee's duties are specified in our Audit Committee Charter.

Compensation Committee

Following the Merger, our Compensation Committee will consist of _____, _____ and _____, each of whom is an independent director. _____ will serve as chairman of the Compensation Committee. The functions of the Compensation Committee will be set forth in a Compensation Committee Charter.

Nominating and Corporate Governance Committee

Following the Merger, our Nominating and Corporate Governance Committee will consist of _____, _____ and _____, each of whom is an independent director under Nasdaq's listing standards. _____ will serve as the chair of the Nominating and Corporate Governance Committee. The Nominating and Corporate Governance Committee is responsible for overseeing the selection of persons to be nominated to serve on our board of directors. The Nominating and Corporate Governance Committee considers persons identified by its members, management, shareholders, investment bankers and others.

The guidelines for selecting nominees, will be specified in the Nominating and Corporate Governance Committee Charter.

Code of Business Conduct and Ethics

Upon the consummation of the Business Combination, we will adopt a new Code of Business Conduct and Ethics for our directors, officers, employees and certain affiliates following the Business Combination in accordance with applicable federal securities laws, a copy of which will be available on the Combined Company's website at www.NauticusRobotics.com. The Combined Company will make a printed copy of the Code of Business Conduct and Ethics available to any stockholder who so requests. Following the Business Combination, requests for a printed copy may be directed to: legal@nautic.us, Attention: Legal Department.

If we amend or grant a waiver of one or more of the provisions of our Code of Business Conduct and Ethics, we intend to satisfy the requirements under Item 5.05 of Form 8-K regarding the disclosure of amendments to or waivers from provisions of our Code of Business Conduct and Ethics that apply to our principal executive officer, principal financial officer and principal accounting officer by posting the required information on the Combined Company's website at www.NauticusRobotics.com. The information on this website is not part of this proxy statement/prospectus.

Officer and Director Compensation Following the Business Combination

Following the consummation of the Business Combination, the Combined Company intends to develop an executive compensation program that is designed to align compensation with the Combined Company's business objectives and the creation of stockholder value, while enabling the Combined Company to attract, retain, incentivize, and reward individuals who contribute to the long-term success of the Combined Company. Decisions on the executive compensation program will be made by the Combined Company's Board and specifically through a compensation committee that the Combined Company's Board will establish.

Executive Compensation

The policies of the Combined Company with respect to the compensation of its executive officers and following the Business Combination will be administered by the Combined Company's Board and specifically through the compensation committee that the Combined Company's Board will establish. We expect that the compensation policies followed by the Combined Company will be designed to provide for compensation that is sufficient to attract, motivate and retain executives of the Combined Company and to establish an appropriate relationship between executive compensation and the creation of stockholder value.

The Combined Company's Board and the compensation committee may utilize the services of third parties from time to time in connection with the recruiting, hiring and determination of compensation awarded to executive employees.

As more fully described in the section entitled "*Directors and Executive Officers of Nauticus — Narrative Disclosure to Summary Compensation Table — Employment Agreements — New Employment Agreement*," Mr. Radford, the Company entered into an employment agreement with Mr. Radford, dated December 16, 2021, which will become effective upon the closing of the Business Combination.

Incentive Award Plan

Following the Business Combination, we expect the Combined Company to use incentive awards in future years to encourage the profitability and growth of the Combined Company through short-term and long-term incentives that are consistent with the Combined Company's objectives, give participants an incentive for excellence in individual performance, promote teamwork among participants, and give the Combined Company a significant advantage in attracting and retaining key employees, non-employee directors and consultants. For a description of the Incentive Award Plan and the types of incentive awards available thereunder, please see "*Proposal 6 — The Stock Plan Proposal*." A copy of the Incentive Award Plan is included in this proxy statement/prospectus as *Annex D*.

Director Compensation

It is anticipated that the Combined Company's Board will determine the annual compensation to be paid to the members of the Combined Company's Board upon completion of the Business Combination. In connection with the consummation of the Business Combination, the Combined Company's Board intends to adopt a non-employee director compensation policy that will be applicable to each of its nonemployee directors and that will be consistent with industry standards and practice.

SECURITY OWNERSHIP OF CERTAIN BENEFICIAL OWNERS AND MANAGEMENT

The following table sets forth information regarding the beneficial ownership of shares of our common stock as of _____, 2022 pre-Business Combination and immediately after the consummation of the Business Combination by:

- each person or “group” (as such term is used in Section 13(d)(3) of the Exchange Act) known by CLAQ to be the beneficial owner of more than 5% of shares of our common stock as of _____, 2022 (pre-Business Combination) or of shares of our common stock upon the closing of the Business Combination;
- each of CLAQ’s executive officers and directors;
- each person who will become an executive officer or director of the Combined Company upon the closing of the Business Combination;
- all of our current executive officers and directors as a group; and
- all executive officers and directors of the Combined Company as a group upon the closing of the Business Combination.

As of the Record Date, CLAQ had _____ shares of common stock issued and outstanding.

Beneficial ownership is determined in accordance with SEC rules and includes voting or investment power with respect to securities. Except as indicated by the footnotes below, CLAQ believes, based on the information furnished to it, that the persons and entities named in the table below have, or will have immediately after the consummation of the Business Combination, sole voting and investment power with respect to all shares of our common stock that they beneficially own, subject to applicable community property laws. Any shares of our common stock subject to options or Warrants exercisable within 60 days of the consummation of the Business Combination are deemed to be outstanding and beneficially owned by the persons holding those options or Warrants for the purpose of computing the number of shares beneficially owned and the percentage ownership of that person. They are not, however, deemed to be outstanding and beneficially owned for the purpose of computing the percentage ownership of any other person.

Subject to the paragraph above, percentage ownership of outstanding shares is based on _____ shares of our common stock to be outstanding upon consummation of the Business Combination, inclusive of the PIPE Investment and the conversion of the CLAQ Rights at the closing of the Business Combination. If the actual facts are different than these assumptions (which they are likely to be), the percentage ownership retained by CLAQ’s existing stockholders in CLAQ will be different.

The expected beneficial ownership of common stock post-Business Combination under the header “Post-Business Combination — Assuming No Redemption” assumes none of the Public Common Stock having been redeemed.

The expected beneficial ownership of common stock post-Business Combination under the header “Post-Business Combination — Assuming Maximum Redemption” assumes _____ Public Common Stock having been redeemed.

Name and Address of Beneficial Owner ⁽¹⁾	Pre-Business Combination		Post-Business Combination			
	Number of Shares		Assuming No Redemption		Assuming Maximum Redemption	
	Number of Shares Beneficially Owned	% of Class	Number of Shares	% of Class	Number of Shares	% of Class
Five Percent Holders of CLAQ and the Combined Company						
CleanTech Sponsor I LLC ⁽²⁾	2,595,000	12.0%				
CleanTech Investments ⁽³⁾	1,437,500	6.7%				
Highbridge Capital Management, LLC ⁽⁴⁾	1,375,859	6.4%				
Boothbay Fund Management, LLC ⁽⁵⁾	1,400,000	6.5%				
Weiss Asset Management LP ⁽⁶⁾	1,725,144	8.0%				
Polar Asset Management Partners Inc. ⁽⁷⁾	1,150,000	5.3%				
ATW Spac Management LLC ⁽⁸⁾	1,400,000	6.5%				
Directors and Named Executive Officers of CLAQ						
Eli Spiro ⁽²⁾	2,595,000	12.0%				
Richard Fitzgerald	—	—				
Louis Buffalino	—	—				
Ankur Dhanuka	—	—				
Jon Najarian	50,000	*				
Governor Bill Richardson	100,000	*				
Brendan Riley	30,000	*				
Britt E. Ide	20,000	*				
Jonas Grossman ⁽³⁾	1,437,500	6.7%				
Douglas Cole	20,000	*				
All Directors and Executive Officers of CLAQ as a Group (10 individuals)						
	4,252,500	19.7%				
Directors and Named Executive Officers Post-Business Combination						
Nicolaus Radford	3,860,015		3,860,015		3,860,015	
Donnelly A. Bohan	—		—		—	
Rangan Padmanabhan	—		—		—	
Dilshad Kasmani	—		—		—	
Mark Mey	—		—		—	
Lisa Porter	—		—		—	
Jim Bellingham	—		—		—	
Adam Sharkawy	—		—		—	
John W. Gibson Jr.	—		—		—	
Joseph W. Dyer	—		—		—	
Eli Spiro	2,595,000		2,595,000		2,595,000	
All Directors and Executive Officers post-Business Combination as a group (11 individuals)						

* Less than 1%.

- (1) The business address of each of the individuals is c/o CleanTech Acquisition Corp., 207 West 25th Street, 9th Floor, New York, NY 10001.
- (2) Consists of shares of common stock owned by CleanTech Sponsor I LLC, for which Eli Spiro is the managing member. Assuming the conversion and exercise of 8,625,000 Public Warrants issued in the IPO, 7,175,000 Private Warrants (of which 4,783,333 Private Warrants sold to the CleanTech Sponsor I LLC), 3,977,368 Nauticus Options, 3,036,735 shares

Table of Contents

- of Common Stock pursuant to the conversion of the Debentures and 3,036,735 shares of Common Stock pursuant to the full exercise of the Warrants, post-dilution ownership would be approximately 8.3%, 8.4%, 9.1%, 9.6% and 10.2% under the No Redemptions, 10% Redemption, 50% Redemption, 75% Redemption, and Maximum Redemption scenarios, respectively. See “Risk Factors — Risks Related to CLAQ’s Business and the Business Combination — The CLAQ Public Stockholders will experience dilution as a consequence of, among other transactions, the issuance of Common Stock as consideration in the Business Combination and the PIPE Investment” for additional information related to the risk of dilution to our public stockholders.
- (3) Consists of shares of common stock owned by CleanTech Investments, for which Jonas Grossman is the managing member. Assuming the conversion and exercise of 8,625,000 Public Warrants issued in the IPO, 7,175,000 Private Warrants (of which 2,391,667 Private Warrants sold to the CleanTech Investments), 3,977,368 Nauticus Options, 3,036,735 shares of Common Stock pursuant to the conversion of the Debentures and 3,036,735 shares of Common Stock pursuant to the full exercise of the Warrants, post-dilution ownership would be approximately 4.3%, 4.4%, 4.7%, 5.0% and 5.3% under the No Redemptions, 10% Redemption, 50% Redemption, 75% Redemption, and Maximum Redemption scenarios, respectively. See “Risk Factors — Risks Related to CLAQ’s Business and the Business Combination — The CLAQ Public Stockholders will experience dilution as a consequence of, among other transactions, the issuance of Common Stock as consideration in the Business Combination and the PIPE Investment” for additional information related to the risk of dilution to our public stockholders. CleanTech Investments is an affiliate of Chardan Capital Markets, LLC.
- (4) Based on a Schedule 13G filed on February 3, 2022 by the reporting person. The address for the reporting persons is 277 Park Avenue, 23rd Floor, New York, New York 10172. Highbridge Capital Management, LLC, a Delaware limited liability company and the investment adviser to certain funds and accounts (the “Highbridge Funds”), has the right to receive or the power to direct the receipt of dividends from, or the proceeds from the sale of, the shares of common stock directly held by the Highbridge Funds.
- (5) Based on a Schedule 13G filed on February 4, 2022 by the reporting persons. The address for the reporting persons is 140 East 45th Street, 14th Floor, New York, NY 10017. The shares of common stock are held by Boothbay Fund Management, LLC, Boothbay Absolute Return Strategies LP, and Ari Glass, who are deemed to beneficially own an aggregate of 1,400,000 shares of common stock.
- (6) Based on a Schedule 13G filed on February 7, 2022 by the reporting persons. The address for the reporting persons is 222 Berkeley St., 16th floor, Boston, Massachusetts 02116. Weiss Asset Management LP is the sole investment manager to a private investment partnership, and private investment funds. WAM GP is the sole general partner of Weiss Asset Management. Andrew Weiss is the managing member of WAM GP. Shares reported for WAM GP, Andrew Weiss and Weiss Asset Management include shares beneficially owned by the partnership and the funds. Each of WAM GP, Weiss Asset Management, and Andrew Weiss disclaims beneficial ownership of the shares reported herein as beneficially owned by each except to the extent of their respective pecuniary interest therein.
- (7) Based on a Schedule 13G filed on February 8, 2021 by the reporting person. The reporting person has a business address of 401 Bay Street, Suite 1900, PO Box 19, Toronto, Ontario M5H 2Y4, Canada. Polar Asset Management Partners Inc. serves as the investment advisor to Polar Multi-Strategy Master Fund, a Cayman Islands exempted company (“PMSMF”). PMSMF has the right to receive or the power to direct the receipt of dividends from or the proceeds from the sale of more than 5% of the reported shares.
- (8) Based on a Schedule 13G filed on February 14, 2021 by the reporting persons. The address for the reporting persons is 7969 NW 2nd Street, #401 Miami, Florida 33126. The shares of common stock are held by one or more separately managed accounts managed by ATW SPAC Management LLC, a Delaware limited liability company, which has been delegated exclusive authority to vote and/or direct the disposition of such shares of common stock held by such separately managed accounts, which are sub-accounts of one or more pooled investment vehicles managed by a Delaware limited liability company. Antonio Ruiz-Gimenez is the managing member of ATW SPAC Management LLC.

CERTAIN RELATIONSHIPS AND RELATED TRANSACTIONS

CLAQ Related Person Transactions

Founder Shares

In July 2020, CleanTech Sponsor was issued 5,000,000 shares of founder shares for an aggregate price of \$25,000. In February 2021, CLAQ effected a 1.4375-for-1 stock split of its issued and outstanding shares of common stock, resulting in an aggregate of 7,187,500 shares of common stock issued and outstanding.

On February 16, 2021, CleanTech Sponsor paid \$16,667 to CLAQ, which amount was paid to CleanTech Investments, LLC to cancel 4,791,667 of its founder shares that it previously held and immediately thereafter CLAQ issued 4,791,667 founder shares to CleanTech Sponsor. As a result, CleanTech Sponsor owns 4,791,667 founder shares and CleanTech Investments owns 2,395,833 founder shares.

In June 2021, CleanTech Sponsor and CleanTech Investments forfeited for no consideration 1,916,667 founder shares and 958,333 founder shares, respectively, which CLAQ cancelled, resulting in a decrease in the total number of founder shares outstanding from 7,187,500 shares to 4,312,500 shares. As a result, CleanTech Sponsor owns 2,875,000 founder shares and CleanTech Investments owns 1,437,500 founder shares. Subsequently, CleanTech Sponsor transferred an aggregate of 280,000 founder shares to CLAQ officers, directors and certain advisors, retaining only 2,595,000 shares of founder shares.

On the date of the IPO, the founder shares were placed into an escrow account maintained in New York, New York by Continental Stock Transfer & Trust Company, acting as escrow agent. Subject to certain limited exceptions, (i) 50% of the 4,312,500 founder shares will not be released from escrow until the earlier of (A) six (6) months after the closing of the Business Combination, or (B) the date on which the closing price of our shares of common stock equals or exceeds \$12.50 per share for any 20 trading days within any 30-trading day period commencing after the Business Combination; and (ii) the remaining 50% of the founder shares will not be released from escrow until six (6) months after the closing of the Business Combination, or earlier, in either case, if, subsequent to the Business Combination, we consummate a subsequent liquidation, merger, stock exchange or other similar transaction which results in all of our stockholders having the right to exchange their shares of common stock for cash, securities or other property.

Private Warrants

Simultaneously with the closing of the IPO, CLAQ consummated in a private placement the sale of 4,333,333 Private Warrants at a price of \$1.00 per warrant to the CleanTech Sponsor and 2,166,667 Private Warrants to CleanTech Investments, generating total gross proceeds of \$6,500,000. In connection with the underwriters' exercise of their over-allotment option, CLAQ also consummated the sale of an additional 450,000 Private Warrants to CleanTech Sponsor and 225,000 Private Warrants at \$1.00 per Private Warrant to CleanTech Investments, generating additional gross proceeds of \$675,000. Each Private Warrant is exercisable to purchase one share of Common Stock of CLAQ at \$11.50 per share.

Promissory Note

On March 1, 2021, CLAQ issued an unsecured promissory note to CleanTech Sponsor (the "Promissory Note"), pursuant to which CLAQ could borrow an aggregate of up to \$250,000 to cover expenses related to its IPO. The Promissory Note was non-interest bearing and is payable on the earlier of (i) the date on which CLAQ consummates an initial public offering of its securities or (ii) the date on which CLAQ determines not to conduct an initial public offering of its securities. The outstanding balance under the Promissory Note was \$182,856 on June 30, 2021. On July 28, 2021, the Company repaid the outstanding balance under the Promissory Note.

Related Party Loans

In addition, in order to finance transaction costs in connection with an intended initial Business Combination, CLAQ's Co-Sponsors, or the officers and directors may, but are not obligated to, loan the Company funds as may be required. If CLAQ consummates the initial Business Combination, it would repay such loaned amounts. The notes would either be paid upon consummation of CLAQ's initial Business Combination, without interest, or, at the lender's discretion, up to \$500,000 of the notes may be converted upon consummation of the Business Combination into

[Table of Contents](#)

additional Private Warrants to purchase shares of common stock at a conversion price of \$1.00 per Private Warrant (which, for example, would result in the holders being issued Private Warrants to purchase 500,000 shares of common stock if \$500,000 of notes were so converted). Such Private Warrants will be identical to the Private Warrants issued at the closing of the IPO. Loans made by Chardan Capital Markets, LLC or any of its related persons will not be convertible into Private Warrants, and Chardan Capital Markets, LLC and its related persons will have no recourse with respect to their ability to convert their loans into Private Warrants.

On March 23, 2022, CLAQ entered into a Promissory Note with CleanTech Sponsor pursuant to which CLAQ could borrow up to an aggregate of \$267,000. On March 23, 2022, CLAQ drew down \$267,000 under this promissory note. On May 5, 2022, CLAQ entered into a Promissory Note with the CleanTech Investments pursuant to which CLAQ could borrow up to an aggregate of \$133,000. On May 5, 2022, CLAQ drew down \$133,000 under this promissory note. Both March 23, 2022 and May 5, 2022 promissory notes are non-interest bearing and payable upon the earlier of (i) completion of the initial Business Combination or (ii) the date on which CLAQ determines that it is unable to effect a Business Combination. CleanTech Investments is an affiliate of Chardan, and our director, Mr. Jonas Grossman, is the Managing Partner and President of Chardan.

Administrative Support Agreement

CLAQ entered into an agreement, commencing on the July 14, 2021, to pay Chardan up to \$10,000 per month for office space, administrative and support services. Upon the completion of an initial Business Combination, CLAQ will cease paying these monthly fees. CleanTech Investments is an affiliate of Chardan, and our director, Mr. Jonas Grossman, is the Managing Partner and President of Chardan.

Business Combination Marketing Agreement

CLAQ engaged Chardan as an advisor in connection with the initial Business Combination to assist it in holding meetings with the stockholders to discuss the potential Business Combination and the target business's attributes, introduce CLAQ to potential investors that are interested in purchasing the securities in connection with the potential Business Combination, assist CLAQ in obtaining stockholder approval for the Business Combination and assist CLAQ with press releases and public filings in connection with the Business Combination. CLAQ will pay Chardan a marketing fee for such services upon the consummation of the initial Business Combination in an amount equal to, in the aggregate, 3.5% of the gross proceeds of the IPO, including any proceeds from the exercise of the underwriters' over-allotment option. As a result, Chardan will not be entitled to such fee unless CLAQ consummates the initial Business Combination. CleanTech Investments is an affiliate of Chardan, and our director, Mr. Jonas Grossman, is the Managing Partner and President of Chardan.

Securities Purchase Agreement

As of the date of this proxy statement/prospectus, ATW is the only purchaser for the Debentures and associated Warrants in the Debt Financing. ATW is managed by ATW Partners Opportunities Management, LLC, which is an affiliate of Chardan, and our director, Mr. Jonas Grossman, is the Managing Partner and President of Chardan. Chardan will not receive any fees or compensation as a result of ATW's participation in the Debt Financing.

Financial Advisory Agreement

CLAQ also engaged Chardan as (i) the exclusive financial advisor with respect to a business combination involving CLAQ and at least one or more potential targets, and (ii) the exclusive placement agent of any private placement of securities in connection with the business combination. In return for its services under the Financial Advisory Agreement, Chardan will be paid a placement fee of 6.0% of the aggregate gross proceeds received from the PIPE Investment that is not sold to an affiliate of Chardan, at Closing. As a result, Chardan will not be entitled to such fee unless CLAQ consummates the initial Business Combination. Pursuant to the Financial Advisory Agreement, Chardan also has a right of first refusal to act as a book-running manager with minimum economics of 15% for the first two public or private equity offerings by CLAQ or any successor or subsidiary of CLAQ. CleanTech Investments is an affiliate of Chardan, and our director, Mr. Jonas Grossman, is the Managing Partner and President of Chardan.

Related Party Policy

CLAQ's Code of Ethics requires us to avoid, wherever possible, all related party transactions that could result in actual or potential conflicts of interests, except under guidelines approved by the Board (or the audit committee). Related-party transactions are defined as transactions in which (1) the aggregate amount involved will or may be expected to exceed \$120,000 in any calendar year, (2) we or any of our subsidiaries is a participant, and (3) any (a) executive officer, director or nominee for election as a director, (b) greater than 5% beneficial owner of our shares of common stock, or (c) immediate family member, of the persons referred to in clauses (a) and (b), has or will have a direct or indirect material interest (other than solely as a result of being a director or a less than 10% beneficial owner of another entity). A conflict of interest situation can arise when a person takes actions or has interests that may make it difficult to perform his or her work objectively and effectively. Conflicts of interest may also arise if a person, or a member of his or her family, receives improper personal benefits as a result of his or her position.

The audit committee, pursuant to its written charter, will be responsible for reviewing and approving related-party transactions to the extent we enter into such transactions. The audit committee will consider all relevant factors when determining whether to approve a related party transaction, including whether the related party transaction is on terms no less favorable to us than terms generally available from an unaffiliated third-party under the same or similar circumstances and the extent of the related party's interest in the transaction. No director may participate in the approval of any transaction in which he is a related party, but that director is required to provide the audit committee with all material information concerning the transaction. We also require each of our directors and executive officers to complete a directors' and officers' questionnaire that elicits information about related party transactions.

These procedures are intended to determine whether any such related party transaction impairs the independence of a director or presents a conflict of interest on the part of a director, employee or officer.

To further minimize conflicts of interest, we have agreed not to consummate an initial business combination with an entity that is affiliated with any of the Sponsor, officers or directors unless we have obtained an opinion from an independent investment banking firm, or another independent entity that commonly renders valuation opinions, and the approval of a majority of our disinterested independent directors that the business combination is fair to our unaffiliated stockholders from a financial point of view.

Nauticus Related Person Transactions

Stock Options

Pursuant to Nauticus' 2015 Equity Incentive Stock Option Agreement (the "Nauticus Equity Incentive Plan"), Nauticus awards stock options to its employees, officers, and directors. All options issued by the Company vest on the following schedule: 25% of the shares vest one year after the vesting commencement date. The balance of the shares vest in a series of thirty-six (36) successive equal monthly installments measuring from the first anniversary of the vesting commencement date.

Convertible Notes

On July 28, 2020, Nauticus entered into a \$1,500,000 convertible promissory note with Schlumberger Technology Corporation ("Schlumberger," and such note, the "Schlumberger Convertible Note"). The Schlumberger Convertible Note is unsecured, payable upon the earliest to occur of (a) the closing of Nauticus' next sale of Nauticus Series C Preferred Stock (the "Next Equity Financing"), (b) the date on which the Schlumberger Convertible Note would be due and payable upon an event of default, or (c) December 31, 2021, and bears interest at a rate of 4.25% per annum. The Schlumberger Convertible Note is convertible into shares of Nauticus Series C Preferred Stock upon the closing of a Next Equity Financing.

On December 7, 2020, Nauticus entered into a \$1,500,000 convertible promissory note with Transocean Inc. ("Transocean," and such note, the "Transocean Convertible Note"). The Transocean Convertible Note is unsecured, payable upon the earliest to occur of (a) the closing of the Next Equity Financing, (b) the date on which the Schlumberger Convertible Note would be due and payable upon an event of default, or (c) December 31, 2021, and bears interest at a rate of 10% per annum. The Transocean Convertible Note is convertible into shares of Nauticus Series C Preferred Stock upon the closing of a Next Equity Financing.

[Table of Contents](#)

On June 19, 2021, Nauticus entered into a \$5,000,000 convertible promissory note with Goradia Capital, LLC (“Goradia,” and such note, the “Goradia Convertible Note”). The Goradia Convertible Note is unsecured, payable upon the earliest to occur of (a) the closing of a Nauticus Series C Preferred Stock equity financing (a “Qualified Financing”), (b) the closing of a transaction where any person or group of persons becomes a beneficial owner, directly or indirectly, of 51% or more of the outstanding equity interests of Nauticus (a “Change of Control Transaction”), and (c) December 31, 2022, unless earlier accelerated following an event of default, and bears interest at a rate of 10% per annum. The Goradia Convertible Note is convertible into shares of Series C Preferred Stock upon a Qualified Financing or Series B Preferred Stock upon a Change of Control Transaction.

On August 3, 2021, Nauticus entered into a \$5,000,000 convertible promissory note with Material Impact Fund II, L.P. (“Material Impact,” and such note, the “Material Impact Convertible Note.”) The Material Impact Convertible Note is unsecured, payable upon the earliest to occur of (a) a Qualified Financing, (b) a Change of Control Transaction, and (c) December 31, 2022, and bears interest at a rate of 5% per annum. The Material Impact Convertible Note is convertible into shares of Series C Preferred Stock upon a Qualified Financing or Series B Preferred Stock upon a Change of Control Transaction.

On October 22, 2021, Nauticus entered into a \$250,000 convertible promissory note with In-Q-Tel, Inc. (“In-Q-Tel,” and such note, the “In-Q-Tel Convertible Note”). The In-Q-Tel Convertible Note is unsecured, payable upon the earliest to occur of (a) a Qualified Financing, (b) a Change of Control Transaction, and (c) December 31, 2022, and bears interest at a rate of 5% per annum. The In-Q-Tel Convertible Note is convertible into shares of Series C Preferred Stock upon a Qualified Financing or Series B Preferred Stock upon a Change of Control Transaction.

On December 16, 2021 and in connection with the signing of the Merger Agreement, Nauticus entered into (i) the First Amendment to Convertible Promissory Note with Schlumberger (the “Amended Schlumberger Convertible Note”), (ii) the First Amendment to Convertible Promissory Note with Transocean (the “Amended Transocean Convertible Note”), (iii) the First Amendment to Unsecured Convertible Promissory Note with Goradia (the “Amended Goradia Convertible Note”), (iv) the First Amendment to Unsecured Convertible Promissory Note with Material Impact (the “Amended Material Impact Convertible Note”), and (v) the First Amendment to Unsecured Convertible Promissory Note with In-Q-Tel (the “Amended In-Q-Tel Convertible Note,” and, together with the Amended Schlumberger Convertible Note, Amended Transocean Convertible Note, Amended Goradia Convertible Note, and Amended Material Impact Convertible Note, the “Amended Convertible Notes”). The Amended Convertible Notes provide for, among other things, the automatic conversion of such Amended Convertible Notes immediately prior to the Effective Time into shares of Nauticus Common Stock at a specific conversion price, which shares will then be exchange for CleanTech Common Stock in connection with the Business Combination. The Amended Convertible Notes established fixed outstanding balances for each not, which will remain unchanged until their conversion.

As a result of the Merger, an aggregate of 4,850,999 shares of CLAQ Common Stock will be issued to the holders of Nauticus Convertible Notes. Please see “*Risk Factors — CLAQ’s stockholders will experience immediate dilution as a consequence of the issuance of common stock as consideration in the Business Combination, PIPE Investment and the Nauticus Convertible Notes Conversion. Having a minority share position may reduce the influence that CLAQ’s current stockholders have on the management of CLAQ*” for dilution considerations.

Transocean

Transocean, Inc. (“Transocean”) is an investor in Nauticus Robotics, Inc. since March 2018, holding 31% equity in the form of preferred stock in the company. As a preferred investor, Transocean, Inc. is represented on the Nauticus Board of Directors by Roddie Mackenzie. Transocean also provided a note of \$1.5MM of convertible stock on maturity of the note.

Transocean, Inc. has contracted with Nauticus in two (2) technology projects since their initial investment in 2018 — “Spiral” and “HaloGuard”. The Spiral project involved methods for automating the handling of drilling pipe on a drilling rig. The Spiral contract resulted in \$734K in revenue in 2019. The project was discontinued by Transocean due to a number of factors within the oil & gas market. HaloGuard involved the development of a zone monitoring safety system to detect personnel in hazardous areas of the drilling rig. This project began as a project code named THEIA, later renamed to HaloGuard, with initial funding provided by Transocean. Nauticus assumed all funding of the project in 2020. Nauticus has sold 7 HaloGuard safety systems to Transocean and is in the process of installing the remaining systems on Transocean’s drilling ships. Nauticus’ revenue from the sales of the HaloGuard system, including installation service fees, are approximately \$2,429,861. As of the date of this prospectus, Nauticus and Transocean are negotiating an end to Nauticus’ support on the product line in order to focus more on the mainline revenue generating items for Nauticus.

Stock Repurchase Agreements

On May 12, 2021, Nauticus entered into Amended and Restated Founder’s Stock Repurchase Agreements with certain key employees, officers and directors of Nauticus (each, a “Stock Repurchase Agreement” and, together, the “Stock Repurchase Agreements”). Pursuant to the Stock Repurchase Agreements, among other things, upon the termination of employment with Nauticus, Nauticus has the right (but not the obligation) to purchase and each such signatory has the obligation to sell, all of their Nauticus Common Stock to Nauticus. Additionally, the key employees, officers and directors signatory to the Stock Repurchase Agreements are subject to repurchase if the owners of more than fifty percent (50%) of the outstanding Nauticus Common Stock receive an offer to purchase their shares of Nauticus Common Stock and which offer is contingent on the offeror’s ability to purchase 100% of the Nauticus Common Stock outstanding.

Series A Financing

On August 28, 2015, pursuant to a Series A Preferred Stock Purchase Agreement by and between Nauticus and Schlumberger (the “Series A Stock Purchase Agreement”), Nauticus issued and sold an aggregate of 3,348 shares of Nauticus Series A Preferred Stock at a purchase price of \$896.00 per share for aggregate consideration of approximately \$3,000,000 (the “Series A Financing”).

The participant in the Series A Financing was a holder of more than 5% of Nauticus’ capital stock. The following table sets forth the aggregate number of Nauticus Series A Preferred Stock issued to Schlumberger in the Series A Financing:

Stockholder	Shares of Series B Preferred Stock	Total Purchase Price
Schlumberger Technology Corporation	3,348	\$ 2,999,808.00

Series B Financing

On March 20, 2018, pursuant to a Series B Stock Purchase Agreement, by and among Nauticus, Schlumberger, and Transocean (the “Series B Stock Purchase Agreement”), Nauticus issued and sold an aggregate of 725,426 shares of Nauticus Series B Preferred Stock at a purchase price of \$27.57 per share for aggregate consideration of approximately \$20,000,000 (the “Series B Financing”).

The participants in the Series B Financing included certain holder of more than 5% of Nauticus’ capital stock. The following table sets forth the aggregate number of Nauticus Series B Preferred Stock issued to these related parties in the Series B Financing:

Stockholder	Shares of Series B Preferred Stock	Total Purchase Price
Schlumberger Technology Corporation	181,356	\$ 4,999,984.92
Transocean, Inc.	544,070	\$ 15,000,009.90

Following the Series B Financing, Nauticus filed a Second Amended and Restated Certificate of Formation (the “Amended and Restated Nauticus Charter”) with the Texas Secretary of State, pursuant to which the Nauticus Series A Preferred Stock underwent a 100-for-1 stock split.

Related Person Transaction Policy

Effective upon the consummation of the Business Combination, the Combined Company expects to adopt a related person transaction policy that sets forth its procedures for the identification, review, consideration and approval or ratification of related person transactions. The policy will become effective upon the consummation of the Business Combination. For purposes of the Combined Company’s policy only, a related person transaction is a transaction, arrangement or relationship, or any series of similar transactions, arrangements or relationships, in which the Combined Company and any related person are, were or will be participants in which the amount involved exceeds \$120,000. Transactions involving compensation for services provided to the Combined Company as an employee or director are

[Table of Contents](#)

not covered by this policy. A related person is any executive officer, director or beneficial owner of more than 5% of any class of the Combined Company's voting securities and any of their respective immediate family members and any entity owned or controlled by such persons.

Under the policy, if a transaction has been identified as a related person transaction, including any transaction that was not a related person transaction when originally consummated or any transaction that was not initially identified as a related person transaction prior to consummation, the Combined Company's management must present information regarding the related person transaction to the Combined Company's audit committee, or, if audit committee approval would be inappropriate, to another independent body of the Combined Company's Board of Directors, for review, consideration and approval or ratification. The presentation must include a description of, among other things, the material facts, the interests, direct and indirect, of the related persons, the benefits to the Combined Company of the transaction and whether the transaction is on terms that are comparable to the terms available to or from, as the case may be, an unrelated third party or to or from employees generally. Under the policy, the Combined Company will collect information that the Combined Company deems reasonably necessary from each director, executive officer and, to the extent feasible, significant stockholder to enable the Combined Company to identify any existing or potential related-person transactions and to effectuate the terms of the policy. In addition, under the Combined Company's Code of Conduct that the Combined Company expects to adopt prior to the closing of this Business Combination, the Combined Company's employees and directors will have an affirmative responsibility to disclose any transaction or relationship that reasonably could be expected to give rise to a conflict of interest. In considering related person transactions, the Combined Company's audit committee, or other independent body of the Combined Company's Board of Directors, will take into account the relevant available facts and circumstances including, but not limited to:

- the risks, costs and benefits to the Combined Company;
- the impact on a director's independence in the event that the related person is a director, immediate family member of a director or an entity with which a director is affiliated;
- the availability of other sources for comparable services or products; and
- the terms available to or from, as the case may be, unrelated third parties or to or from employees generally.

The policy requires that, in determining whether to approve, ratify or reject a related person transaction, the Combined Company's audit committee, or other independent body of the Combined Company's Board of Directors, must consider, in light of known circumstances, whether the transaction is in, or is not inconsistent with, the Combined Company's best interests and those of the Combined Company's stockholders, as the Combined Company's audit committee, or other independent body of the Combined Company's Board of Directors, determines in the good faith exercise of its discretion.

LEGAL MATTERS

The validity of the shares of Common Stock to be issued pursuant to the Merger Agreement will be passed upon by Loeb & Loeb LLP, counsel to CleanTech Acquisition Corp.

EXPERTS

The consolidated financial statements of CleanTech Acquisition Corp. as of December 31, 2021 and 2020, and for the year ended December 31, 2021 and for the period from June 18, 2020 (inception) through December 31, 2020, appearing in this proxy statement/prospectus have been audited by WithumSmith+Brown, PC, independent registered public accounting firm, as set forth in their report thereon, appearing elsewhere in this proxy statement, and are included in reliance upon such report given on the authority of such firm as experts in accounting and auditing.

The financial statements of Nauticus Robotics, Inc. as of December 31, 2021 and 2020 and for the years then ended included in this proxy statement/prospectus have been so included in reliance on the report of Whitley Penn LLP, an independent registered public accounting firm, given on the authority of said firm as experts in auditing and accounting.

APPRAISAL RIGHTS

CLAQ — Appraisal Rights

CLAQ stockholders do not have appraisal rights in connection with the Business Combination under Delaware law.

Nauticus — Appraisal Rights

Under Texas law, Nauticus stockholders will have rights of dissent and appraisal with respect to a fundamental business transaction, defined as a merger, interest exchange, conversion, or sale of all or substantially all assets. However, under Texas law, Nauticus stockholders may not dissent from a plan of merger or conversion in which there is a single surviving or new Texas entity, or from a plan of exchange, if (i) the stockholder is not required by the terms of the plan of merger, conversion, or exchange to accept for the stockholder's ownership interest any consideration that is different from the consideration to be provided to any other holder of an ownership interest of the same class or series as the ownership interest held by the owner; and (ii) the stockholder is not required by the terms of the plan of merger, conversion, or exchange to accept for the stockholder's ownership interest any consideration other than (A) ownership interests, or depository receipts in respect of ownership interests, that, immediately after the effective date of the merger, conversion, or exchange will be part of a class or series of ownership interests, or depository receipts in respect of ownership interests, that are (1) listed on a national securities exchange or authorized for listing on the exchange on official notice of issuance; or (2) held of record by at least 2,000 owners; (B) cash instead of fractional ownership interests the stockholder would otherwise be entitled to receive; or (C) any combination of such ownership interests and cash.

In accordance with Section 10.354 of the Texas Business Organization Code, no appraisal rights shall be available to holders of shares in connection with the Merger.

DELIVERY OF DOCUMENTS TO STOCKHOLDERS

Pursuant to the rules of the SEC, we and servicers that we employ to deliver communications to our stockholders are permitted to deliver to two or more stockholders sharing the same address a single copy of the proxy statement. Upon written or oral request, we will deliver a separate copy of the proxy statement/prospectus to any stockholder at a shared address to which a single copy of the proxy statement/prospectus was delivered and who wishes to receive separate copies in the future. Stockholders receiving multiple copies of the proxy statement/prospectus may likewise request that we deliver single copies of the proxy statement/prospectus in the future. Stockholders may notify us of their requests by calling or writing to Advantage Proxy, our proxy solicitor at:

ADVANTAGE PROXY
P.O. Box 13581
Des Moines, WA 98198
Toll Free: (877) 870-8565
Collect: (206) 870-8565
Email: ksmith@advantageproxy.com

TRANSFER AGENT AND REGISTRAR

The transfer agent for our securities is Continental.

SUBMISSION OF STOCKHOLDER PROPOSALS

Our Board is aware of no other matter that may be brought before the Meeting. Under Delaware law, only business that is specified in the notice of a special meeting to stockholders may be transacted at the Meeting.

FUTURE STOCKHOLDER PROPOSALS

Stockholder proposals, including director nominations, for the 2022 annual meeting must be received at our principal executive offices by not earlier than the opening of business on the 120th day before the 2022 annual meeting and not later than the later of (x) the close of business on the 90th day before the 2022 annual meeting or (y) the close of business on the 10th day following the first day on which we publicly announce the date of the 2022 annual meeting, and must otherwise comply with applicable SEC rules and the advance notice provisions of our bylaws, to be considered for inclusion in our proxy materials relating to our 2022 annual meeting.

You may contact our Secretary at our principal executive offices for a copy of the relevant bylaw provisions regarding the requirements for making stockholder proposals and nominating director candidates.

WHERE YOU CAN FIND MORE INFORMATION

We must comply with the informational requirements of the Securities Exchange Act of 1934, as amended (the "Exchange Act") and its rules and regulations, and in accordance with the Exchange Act, we file annual, quarterly, and current reports, proxy statements, and other information with the SEC. You can read CLAQ's SEC filings, including this proxy statement, over the Internet at the SEC's website at <http://www.sec.gov>. If you would like additional copies of this proxy statement/prospectus or if you have questions about the Business Combination or the Proposals to be presented at the Meeting, you should contact our proxy solicitation agent at the following address and telephone number:

ADVANTAGE PROXY
P.O. Box 13581
Des Moines, WA 98198
Toll Free: (877) 870-8565
Collect: (206) 870-8565
Email: ksmith@advantageproxy.com

If you are a stockholder of CLAQ and would like to request documents, please do so by _____, 2022, in order to receive them before the Meeting. If you request any documents from us, we will mail them to you by first class mail, or another equally prompt means.

All information contained in this proxy statement/prospectus relating to CLAQ has been supplied by CLAQ, and all such information relating to Nauticus has been supplied by Nauticus. Information provided by either the CLAQ or Nauticus does not constitute any representation, estimate or projection of any other party.

This document is a proxy statement of CLAQ for the Meeting. We have not authorized anyone to give any information or make any representation about the Business Combination, us or Nauticus that is different from, or in addition to, that contained in this proxy statement. Therefore, if anyone does give you information of this sort, you should not rely on it. The information contained in this proxy statement/prospectus speaks only as of the date of this proxy statement/prospectus unless the information specifically indicates that another date applies.

INDEX TO FINANCIAL STATEMENTS**CLEANTECH ACQUISITION CORP.**

	Page
CONSOLIDATED FINANCIAL STATEMENTS	
Report of Independent Registered Public Accounting Firm	F-2
Consolidated Balance Sheets as of December 31, 2021 and December 31, 2020	F-3
Consolidated Statements of Operations for the year ended December 31, 2021 and for the period from June 18, 2020 (inception) through December 31, 2020	F-4
Consolidated Statements of Changes in Stockholders' Equity (Deficit) for the year ended December 31, 2021 and for the period from June 18, 2020 (inception) through December 31, 2020	F-5
Consolidated Statements of Cash Flows for the year ended December 31, 2021 and for the period from June 18, 2020 (inception) through December 31, 2020	F-6
Notes to Consolidated Financial Statements	F-7
UNAUDITED CONDENSED CONSOLIDATED FINANCIAL STATEMENTS	
Condensed Consolidated Balance Sheets as of March 31, 2022 (unaudited) and December 31, 2021	F-28
Unaudited Condensed Consolidated Statements of Operations for the three months ended March 31, 2022 and 2021	F-29
Condensed Consolidated Statements of Changes in Stockholders' Equity (Deficit) for the three months ended March 31, 2022 and 2021	F-30
Unaudited Condensed Consolidated Statement of Cash Flows for the three months ended March 31, 2022 and 2021	F-31
Notes to Unaudited Condensed Financial Statements	F-32

NAUTICUS ROBOTICS, INC.

FINANCIAL STATEMENTS	
Report of Independent Registered Public Accounting Firm (PCAOB ID 726)	F-52
Balance Sheets as of December 31, 2021 and December 31, 2020	F-54
Statements of Operations for the years ended December 31, 2021 and December 31, 2020	F-55
Statements of Changes in Stockholders' Equity (Deficit) for the years ended December 31, 2021 and December 31, 2020	F-56
Statements of Cash Flows for the years ended December 31, 2021 and December 31, 2020	F-57
Notes to Financial Statements	F-58
UNAUDITED CONDENSED FINANCIAL STATEMENTS	
Report of Independent Registered Public Accounting Firm	F-73
Condensed Balance Sheets (Unaudited)	F-74
Condensed Statements of Operations (Unaudited)	F-75
Condensed Statements of Changes of Stockholders' Equity (Deficit)(Unaudited)	F-76
Condensed Statements of Cash Flows (Unaudited)	F-77
Notes to Condensed Financial Statements (Unaudited)	F-78

REPORT OF INDEPENDENT REGISTERED PUBLIC ACCOUNTING FIRM

To the Stockholders and the Board of Directors of
CleanTech Acquisition Corp.

Opinion on the Consolidated Financial Statements

We have audited the accompanying consolidated balance sheets of CleanTech Acquisition Corp. (the “Company”) as of December 31, 2021 and 2020, the related consolidated statements of operations, changes in stockholders’ equity (deficit) and cash flows for the year ended December 31, 2021 and for the period from June 18, 2020 (inception) through December 31, 2020, and the related notes (collectively referred to as the “consolidated financial statements”). In our opinion, the consolidated financial statements present fairly, in all material respects, the financial position of the Company as of December 31, 2021 and 2020, and the results of its operations and its cash flows for the year ended December 31, 2021 and for the period from June 18, 2020 (inception) through December 31, 2020, in conformity with accounting principles generally accepted in the United States of America.

Going Concern

The accompanying consolidated financial statements have been prepared assuming that the Company will continue as a going concern. As discussed in Note 1 to the consolidated financial statements, if the Company is unable to raise additional funds to alleviate liquidity needs and complete a business combination by July 19, 2022 then the Company will cease all operations except for the purpose of liquidating. The liquidity condition and date for mandatory liquidation and subsequent dissolution raise substantial doubt about the Company’s ability to continue as a going concern. Management’s plans in regard to these matters are also described in Note 1. The consolidated financial statements do not include any adjustments that might result from the outcome of this uncertainty.

Basis for Opinion

These consolidated financial statements are the responsibility of the Company’s management. Our responsibility is to express an opinion on the Company’s consolidated financial statements based on our audits. We are a public accounting firm registered with the Public Company Accounting Oversight Board (United States) (“PCAOB”) and are required to be independent with respect to the Company in accordance with the U.S. federal securities laws and the applicable rules and regulations of the Securities and Exchange Commission and the PCAOB.

We conducted our audits in accordance with the standards of the PCAOB. Those standards require that we plan and perform the audits to obtain reasonable assurance about whether the consolidated financial statements are free of material misstatement, whether due to error or fraud. The Company is not required to have, nor were we engaged to perform, an audit of its internal control over financial reporting. As part of our audits we are required to obtain an understanding of internal control over financial reporting but not for the purpose of expressing an opinion on the effectiveness of the Company’s internal control over financial reporting. Accordingly, we express no such opinion.

Our audits included performing procedures to assess the risks of material misstatement of the consolidated financial statements, whether due to error or fraud, and performing procedures that respond to those risks. Such procedures included examining, on a test basis, evidence regarding the amounts and disclosures in the consolidated financial statements. Our audits also included evaluating the accounting principles used and significant estimates made by management, as well as evaluating the overall presentation of the consolidated financial statements. We believe that our audits provide a reasonable basis for our opinion.

/s/ WithumSmith+Brown, PC

We have served as the Company’s auditor since 2021.

New York, New York
March 29, 2022

PCAOB ID Number 100

**CLEANTECH ACQUISITION CORP.
CONSOLIDATED BALANCE SHEETS**

	December 31, 2021	December 31, 2020
ASSETS		
Current assets:		
Cash	\$ 518,905	\$ 25,000
Prepaid expenses	73,865	—
Total current assets	592,770	25,000
Investments held in Trust Account	174,230,428	—
Total Assets	\$ 174,823,198	\$ 25,000
LIABILITIES, COMMON STOCK SUBJECT TO POSSIBLE REDEMPTION AND STOCKHOLDERS' (DEFICIT) EQUITY		
Current liabilities:		
Accounts payable	\$ 153,601	\$ —
Accrued expenses	29,500	1,000
Accrued expenses – related party	53,333	—
Franchise tax payable	97,200	—
Total current liabilities	333,634	1,000
Warrant liabilities	7,973,250	—
Total Liabilities	8,306,884	1,000
Commitments and Contingencies		
Common stock subject to possible redemption, \$0.0001 par value; 17,250,000 and 0 shares issued and outstanding at redemption value at December 31, 2021 and December 31, 2020, respectively	174,225,000	—
Stockholders' (Deficit) Equity		
Preferred stock, \$0.0001 par value; 1,000,000 shares authorized; 0 shares issued and outstanding at December 31, 2021 and December 31, 2020	—	—
Common stock, \$0.0001 par value; 200,000,000 shares authorized; 4,312,500 shares issued and outstanding (excluding 17,250,000 and 0 shares subject to possible redemption) at December 31, 2021 and December 31, 2020	431	431
Additional paid-in capital	—	24,569
Accumulated deficit	(7,709,117)	(1,000)
Total Stockholders' (Deficit) Equity	(7,708,686)	24,000
TOTAL LIABILITIES, COMMON STOCK SUBJECT TO POSSIBLE REDEMPTION AND STOCKHOLDERS' (DEFICIT) EQUITY	\$ 174,823,198	\$ 25,000

The accompanying notes are an integral part of these consolidated financial statements.

CLEANTECH ACQUISITION CORP.
CONSOLIDATED STATEMENTS OF OPERATIONS

	For the year ended December 31, 2021	For the period from June 18, 2020 (inception) through December 31, 2020
Operating and formation costs	\$ 1,201,383	\$ 1,000
Franchise tax expense	97,200	—
Loss from operations	(1,298,583)	(1,000)
Transaction costs allocated to warrant liabilities	(155,037)	—
Net gain on investments held in Trust Account	5,428	—
Change in fair value of warrant liabilities	1,077,750	—
Change in fair value of over-allotment option liability	(225,000)	—
Net loss	\$ (595,442)	\$ (1,000)
Basic weighted average shares outstanding	11,781,678	3,750,000
Basic net loss per share of Common Stock	\$ (0.05)	\$ (0.00)

The accompanying notes are an integral part of these consolidated financial statements.

CLEANTECH ACQUISITION CORP.
CONSOLIDATED STATEMENTS OF CHANGES IN STOCKHOLDERS' EQUITY (DEFICIT)
FOR THE YEAR ENDED DECEMBER 31, 2021 AND THE PERIOD FROM JUNE 18, 2020
(INCEPTION)
THROUGH DECEMBER 31, 2020

	Common Stock		Additional Paid-in Capital	Accumulated Deficit	Total Stockholders' Equity (Deficit)
	Shares	Amount			
Balance at June 18, 2020 (Inception)	—	\$ —	—	\$ —	\$ —
Sale of 4,312,500 Founder Shares	4,312,500	431	24,569	—	25,000
Net loss	—	—	—	(1,000)	(1,000)
Balance at December 31, 2020	4,312,500	431	24,569	(1,000)	24,000
Net proceeds from Initial Public Offering allocated to Rights	—	—	3,845,970	—	3,845,970
Excess of cash received over fair value of private placement warrants	—	—	4,161,500	—	4,161,500
Change in fair value of over- allotment option liability	—	—	—	225,000	225,000
Accretion of Common Stock to possible redemption amount	—	—	(8,032,039)	(7,337,675)	(15,369,714)
Net loss	—	—	—	(595,442)	(595,442)
Balance at December 31, 2021	4,312,500	\$ 431	\$ —	\$ (7,709,117)	\$ (7,708,686)

The accompanying notes are an integral part of these consolidated financial statements.

CLEANTECH ACQUISITION CORP.
CONSOLIDATED STATEMENTS OF CASH FLOWS

	For the year ended December 31, 2021	For the period from June 18, 2020 (inception) through December 31, 2020
Cash Flows from Operating Activities:		
Net loss	\$ (595,442)	\$ (1,000)
Adjustments to reconcile net loss to net cash used in operating activities:		
Transaction costs allocated to warrant liabilities	155,037	—
Net gain on investments held in Trust Account	(5,428)	—
Change in fair value of warrant liabilities	(1,077,750)	—
Change in fair value of over-allotment option liability	225,000	—
Changes in operating assets and liabilities:		
Prepaid expenses	(73,865)	—
Accounts payable	153,601	—
Accrued expenses	28,500	1,000
Accrued expenses – related party	53,333	—
Franchise tax payable	97,200	—
Net cash used in operating activities	<u>(1,039,814)</u>	<u>—</u>
Cash Flows from Investing Activities:		
Investment of cash in Trust Account	(174,225,000)	—
Net cash used in investing activities	<u>(174,225,000)</u>	<u>—</u>
Cash Flows from Financing Activities:		
Proceeds from promissory note – related party	188,302	—
Repayment of promissory note – related party	(188,302)	—
Payment to related party for cancellation of Founder Shares	(16,667)	—
Proceeds from initial public offering, net of underwriter’s discount paid	169,050,000	—
Proceeds from sale of private placement warrants	7,175,000	—
Payment of offering costs	(466,281)	—
Proceeds from sale of Founder Shares	16,667	25,000
Net cash provided by financing activities	<u>175,758,719</u>	<u>25,000</u>
Net change in cash	493,905	25,000
Cash – beginning of period	<u>25,000</u>	<u>—</u>
Cash – end of period	<u>\$ 518,905</u>	<u>\$ 25,000</u>

The accompanying notes are an integral part of these consolidated financial statements.

CLEANTECH ACQUISITION CORP.
NOTES TO CONSOLIDATED FINANCIAL STATEMENTS
DECEMBER 31, 2021

NOTE 1. DESCRIPTION OF ORGANIZATION AND BUSINESS OPERATIONS

CleanTech Acquisition Corp. (the “Company”) is a blank check company incorporated in Delaware on June 18, 2020. The Company was formed for the purpose of entering into a merger, share exchange, asset acquisition, share purchase, reorganization or similar business combination with one or more businesses or entities (a “Business Combination”). The Company is not limited to a particular industry or geographic region for purposes of consummating a Business Combination. The Company is an early stage and emerging growth company and, as such, the Company is subject to all of the risks associated with early stage and emerging growth companies.

As of December 31, 2021, the Company had not commenced any operations. All activity through December 31, 2021 relates to the Company’s formation and the initial public offering (“Initial Public Offering”), which is described below. The Company will not generate any operating revenues until after the completion of a Business Combination, at the earliest. The Company generates non-operating income in the form of interest income from the proceeds derived from the Initial Public Offering.

The registration statement for the Company’s Initial Public Offering was declared effective on July 14, 2021. On July 19, 2021, the Company consummated the Initial Public Offering of 15,000,000 units (the “Units” and, with respect to the shares of Common Stock included in the Units sold, the “Public Shares”), at \$10.00 per unit, generating gross proceeds of \$150,000,000, which is discussed in Note 3.

Simultaneously with the closing of the Initial Public Offering, the Company consummated the sale of 4,333,333 warrants at a price of \$1.00 per Private Placement Warrant in a private placement to CleanTech Sponsor (the “Sponsor”), and 2,166,667 warrants (together, the “Private Placement Warrants”) at a price of \$1.00 per Private Placement Warrant in a private placement to CleanTech Investments, an affiliate of the Sponsor (the “Co-sponsor”), generating gross proceeds of 6,500,000, which is described in Note 4.

The Company granted the underwriters in the Initial Public Offering (the “Underwriters”) a 45-day option to purchase up to 2,250,000 additional Units to cover over-allotments, if any. On July 28, 2021, the Underwriters exercised the over-allotment option in full and purchased an additional 2,250,000 units (the “Over-Allotment Units”), generating gross proceeds of \$22,500,000.

Simultaneously with the closing of the exercise of the over-allotment option, the Company consummated the sale of 675,000 warrants (the “Over-Allotment Warrants”) at a purchase price of \$1.00 per warrant in a private placement to the Sponsor, generating gross proceeds of \$675,000.

Following the closing of the Initial Public Offering and the over-allotment, an amount of \$174,225,000 from the net proceeds of the sale of the Public Units in the Initial Public Offering and the sale of the Private Warrants was placed in a trust account (the “Trust Account”), and was invested only in U.S. government treasury obligations with maturities of 183 days or less or in money market funds meeting certain conditions under Rule 2a-7 under the Investment Company Act of 1940, as amended (the “Investment Company Act”) which invest only in direct U.S. government treasury obligations, until the earlier of: (i) the completion of a Business Combination and (ii) the distribution of the funds held in the Trust Account, as described below.

Transaction costs related to the issuances described above amounted to \$3,916,281, consisting of \$3,450,000 of underwriting fees and \$466,281 of other costs.

The Company’s management has broad discretion with respect to the specific application of the net proceeds of the Initial Public Offering and the sale of the Private Placement Warrants, although substantially all of the net proceeds are intended to be applied generally toward consummating a Business Combination. There is no assurance that the Company will be able to complete a Business Combination successfully. The Company must complete a Business Combination with one or more target businesses that together have an aggregate fair market value of at least 80% of the value of the Trust Account (as defined below) (excluding the deferred underwriting commissions and taxes payable on income earned on the Trust Account) at the time of the agreement to enter into an initial Business Combination.

CLEANTECH ACQUISITION CORP.
NOTES TO CONSOLIDATED FINANCIAL STATEMENTS
DECEMBER 31, 2021

NOTE 1. DESCRIPTION OF ORGANIZATION AND BUSINESS OPERATIONS (cont.)

The Company will only complete a Business Combination if the post-transaction company owns or acquires 50% or more of the outstanding voting securities of the target or otherwise acquires a controlling interest in the target sufficient for it not to be required to register as an investment company under the Investment Company Act.

The Company, after signing a definitive agreement for an Initial Business Combination, will either (i) seek stockholder approval of the Initial Business Combination at a meeting called for such purpose in connection with which stockholders may seek to redeem their shares, regardless of whether they vote for or against the Initial Business Combination, for cash equal to their pro rata share of the aggregate amount then on deposit in the Trust Account as of two business days prior to the consummation of the Initial Business Combination, including interest but less taxes payable, or (ii) provide stockholders with the opportunity to sell their Public Shares to the Company by means of a tender offer (and thereby avoid the need for a stockholder vote) for an amount in cash equal to their pro rata share of the aggregate amount then on deposit in the Trust Account as of two business days prior to the consummation of the Initial Business Combination, including interest but less taxes payable. The decision as to whether the Company will seek stockholder approval of the Initial Business Combination or will allow stockholders to sell their Public Shares in a tender offer will be made by the Company, solely in its discretion, and will be based on a variety of factors such as the timing of the transaction and whether the terms of the transaction would otherwise require the Company to seek stockholder approval, unless a vote is required by law or under NASDAQ rules. If the Company seeks stockholder approval, it will complete its Initial Business Combination only if a majority of the outstanding shares of Common Stock voted are voted in favor of the Initial Business Combination. However, in no event will the Company redeem its Public Shares in an amount that would cause its net tangible assets to be less than \$5,000,001 either immediately prior to or upon consummation of the Initial Business Combination. In such case, the Company would not proceed with the redemption of its Public Shares and the related Initial Business Combination, and instead may search for an alternate Initial Business Combination.

If the Company seeks stockholder approval of the initial Business Combination and the Company does not conduct redemptions in connection with the Business Combination pursuant to the tender offer rules, the certificate of incorporation provides that a public stockholder, individually or together with any affiliate of such stockholder or any other person with whom such stockholder is acting in concert or as a “group” (as defined under Section 13 of the Exchange Act), will be restricted from seeking redemption rights with respect to more than an aggregate of 20% of the shares sold in the initial public offering. Furthermore, in order for a public stockholder to have his, her or its shares redeemed for cash in connection with any proposed Business Combination, the Company may require that the public stockholders vote either in favor of or against a proposed Business Combination. If required to vote pursuant to the procedures specified in the proxy statement to stockholders relating to the Business Combination, and a public stockholder fails to vote in favor of or against the proposed Business Combination, whether that stockholder abstains from the vote or simply does not vote, that stockholder would not be able to have his, her or its shares of Common Stock redeemed to cash in connection with such Business Combination.

The initial stockholders have agreed to waive their redemption rights with respect to any shares they own in connection with the consummation of the initial Business Combination, including their founder shares and public shares that they have purchased during or after the offering, if any. In addition, the initial stockholders have agreed to waive their rights to liquidating distributions with respect to its founder shares if the Company fails to consummate the initial Business Combination within 12 months (or up to 18 months, as applicable) from the closing of the offering. However, if the initial stockholders acquire public shares in or after the Initial Public Offering, they will be entitled to receive liquidating distributions with respect to such public shares if the Company fails to consummate the initial Business Combination within the required time period.

If the Company does not complete a business combination within 12 months (or up to 18 months, as applicable) from the closing this offering (the “Combination Period”), the Company will (i) cease all operations except for the purpose of winding up, (ii) as promptly as reasonably possible but not more than ten business days thereafter, redeem 100% of the outstanding public shares and (iii) as promptly as reasonably possible following such redemption, subject to the approval of the remaining stockholders and the board of directors, dissolve and liquidate, subject (in the case of

CLEANTECH ACQUISITION CORP.
NOTES TO CONSOLIDATED FINANCIAL STATEMENTS
DECEMBER 31, 2021

NOTE 1. DESCRIPTION OF ORGANIZATION AND BUSINESS OPERATIONS (cont.)

(ii) and (iii) above) to the obligations under Delaware law to provide for claims of creditors and the requirements of other applicable law. There will be no redemption rights or liquidating distributions with respect to the warrants, which will expire worthless if the Company fails to complete the Business Combination within the time period.

In order to protect the amounts in the Trust Account, the Sponsor has agreed that it will be liable to the Company if and to the extent any claims by a third party for services rendered or products sold to the Company, or a prospective target business with which the Company has discussed entering into a transaction agreement, reduce the amount of funds in the Trust Account to below (i) \$10.10 per Public Share or (ii) the actual amount per Public Share held in the Trust Account as of the date of the liquidation of the Trust Account, if less than \$10.10 per Public Share due to reductions in the value of the trust assets, less taxes payable, provided that such liability will not apply to any claims by a third party or prospective target business who executed a waiver of any and all rights to the monies held in the Trust Account (whether or not such waiver is enforceable) nor will it apply to any claims under the Company's indemnity of the underwriters of the Initial Public Offering against certain liabilities, including liabilities under the Securities Act of 1933, as amended (the "Securities Act"). The Company will seek to reduce the possibility that the Sponsor will have to indemnify the Trust Account due to claims of creditors by endeavoring to have all vendors, service providers (except the Company's independent registered public accounting firm), prospective target businesses or other entities with which the Company does business, execute agreements with the Company waiving any right, title, interest or claim of any kind in or to monies held in the Trust Account.

Business Combination Agreement

On December 16, 2021, the Company entered into an Agreement and Plan of Merger, as amended on January 30 and June 6, 2022 through Amendment No. 1 (the "Merger Agreement," and together with the other agreements and transactions contemplated by the Merger Agreement, the "Business Combination") with CleanTech Merger Sub, Inc., a Delaware corporation and a wholly owned subsidiary of CleanTech ("Merger Sub"), and Nauticus Robotics, Inc., a Texas corporation ("Nauticus" or "Nauticus Robotics"). Pursuant to the terms of the Merger Agreement, a business combination between CleanTech and Nauticus will be effected through the merger of Merger Sub with and into Nauticus, with Nauticus surviving the merger as a wholly owned subsidiary of CleanTech (the "Merger"). The Board of Directors of CleanTech (the "Board") has unanimously (i) approved and declared advisable the Merger Agreement, the Merger and the other transactions contemplated thereby and (ii) resolved to recommend approval of the Merger Agreement and related matters by the stockholders of CleanTech.

Preferred Stock. Immediately prior to the effective time of the Merger (the "Effective Time"), each share of Nauticus Preferred Stock that is issued and outstanding immediately prior to such time shall automatically convert into shares of Nauticus Common Stock, par value \$0.01 per share (the "Nauticus Common Stock"), in accordance with its Certificate of Incorporation (collectively, the "Nauticus Preferred Stock Conversion"). An aggregate of 15,062,524 shares of CLAQ Common Stock will be issued to the holders of Nauticus Preferred Stock.

Convertible Notes. Immediately prior to the Effective Time, each of (i) that certain Unsecured Convertible Promissory Note, dated June 19, 2021, by and between Goradia Capital, LLC and Nauticus, as amended on December 16, 2021, (ii) that certain Unsecured Convertible Promissory Note, August 3, 2021, by and between Material Impact Fund II, L.P. and Nauticus, as amended on December 16, 2021, (iii) that certain Unsecured Convertible Promissory Note, dated October 22, 2021, by and between In-Q-Tel, Inc. and Nauticus, as amended on December 16, 2021, (iv) that certain Unsecured Convertible Promissory Note, dated July 28, 2020, by and between Schlumberger Technology Corporation and Nauticus, as amended on December 16, 2021, and (v) that certain Unsecured Convertible Promissory Note, dated December 7, 2020, by and between Transocean Inc. and Nauticus, as amended on December 16, 2021 (each, a "Nauticus Convertible Note" and collectively, the "Nauticus Convertible Notes") shall automatically convert into shares of Nauticus Common Stock in accordance with the terms of each such Nauticus Convertible Note (collectively, the "Nauticus Convertible Notes Conversion"). An aggregate of 5,299,543 shares of CLAQ Common Stock will be issued to the holders of Nauticus Convertible Notes.

CLEANTECH ACQUISITION CORP.
NOTES TO CONSOLIDATED FINANCIAL STATEMENTS
DECEMBER 31, 2021

NOTE 1. DESCRIPTION OF ORGANIZATION AND BUSINESS OPERATIONS (cont.)

Common Stock. At the Effective Time, following the Nauticus Preferred Stock Conversion and Nauticus Convertible Notes Conversion, each share of Nauticus Common Stock (including shares of Nauticus Common Stock outstanding as a result of the Nauticus Preferred Stock Conversion and Nauticus Convertible Notes Conversion, but excluding shares of the holders of which perfect rights of appraisal under Delaware law) will be converted into the right to receive the applicable Per Share Merger Consideration (as defined below) and the Earnout Shares (as defined below). An aggregate of 9,669,216 shares of CLAQ Common Stock will be issued to the holders of Nauticus Common Stock.

Stock Options. At the Effective Time, each outstanding option to purchase shares of Nauticus Common Stock (a “Nauticus Option”), whether or not then vested and exercisable, will be assumed by CLAQ and converted automatically (and without any required action on the part of such holder of outstanding option) into an option to purchase shares of the CLAQ’s Common Stock equal to the number of shares determined by multiplying the number of shares of the Nauticus Common Stock subject to such Nauticus Option immediately prior to the Effective Time by the Exchange Ratio (as defined below), which product shall be rounded down to the nearest whole number of shares, at a per share exercise price determined by dividing the per share exercise price of such Nauticus Option immediately prior to the Effective Time by the Exchange Ratio. Options to purchase an aggregate of 4,055,704 shares of CLAQ Common Stock will be issued to the holders of Nauticus Options.

Earnout Shares. Following the closing of the merger, former holders of shares of Nauticus Common Stock (including shares received as a result of the Nauticus Preferred Stock conversion and the Nauticus Convertible Notes conversion) shall be entitled to receive their pro rata share of up to 7,500,000 additional shares of CleanTech Common Stock (the “Earnout Shares”) if, within a 5-year period following the signing date of the Merger Agreement, the closing share price of the CleanTech Common Stock equals or exceeds any of three thresholds over any 20 trading days within a 30-day trading period (each, a “Triggering Event”).

- (i) one-half of the Escrow Shares will be released if, within a 5-year period following the signing date of the Merger Agreement, the volume-weighted average price of the Combined Company Common Stock equals or exceeds \$15.00 per share over any 20 trading days within a 30-day trading period;
- (ii) one-quarter of the Escrow Shares will be released if, within a 5-year period following the signing date of the Merger Agreement, the volume-weighted average price of the Combined Company Common Stock equals or exceeds \$17.50 per share over any 20 trading days within a 30-day trading period; and
- (iii) one-quarter of the Escrow Shares will be released if, within a 5-year period following the signing date of the Merger Agreement, the volume-weighted average price of the Combined Company Common Stock equals or exceeds \$20.00 per share over any 20 trading days within a 30-day trading period.

On or about December 14, 2021, CLAQ entered into subscription agreements, with certain investors pursuant to which, among other things, CLAQ agreed to issue and sell, in a private placement to close immediately prior to the closing of the Business Combination, an aggregate of 3,530,000 shares of our common stock for \$10.00 per share for a total of \$35.3 million (the “Equity Financing”). On December 16, 2021, CLAQ entered into a Securities Purchase Agreement with certain investors purchasing up to an aggregate of \$40.0 million in principal amount of secured debentures (the “Debentures”) and warrants substantially concurrently with the closing of the Business Combination. The number of shares of common stock into which the Debentures are convertible is equal to 120% of the outstanding principal amount of the Debentures divided by the conversion price of \$15.00, and the number of shares of common stock into which the associated warrants are exercisable is equal to 120% of the outstanding principal amount of the Debentures divided by the conversion price, with an exercise price equal to \$20, subject to adjustment (the “Debt Financing,” and together with the Equity Financing, the “PIPE Investment”). There will be an original issue discount of 2% from the issued amount of the Debentures. Interest will accrue on all outstanding principal amount of the Debentures at 5% per annum, payable quarterly. The Debentures will be secured by first priority interests, and liens on, all present and after-acquired assets of the Combined Company, and will mature on the fourth anniversary of the date of issuance. As of the date of these financial statements, ATW Special Situations I LLC (“ATW”) is the

CLEANTECH ACQUISITION CORP.
NOTES TO CONSOLIDATED FINANCIAL STATEMENTS
DECEMBER 31, 2021

NOTE 1. DESCRIPTION OF ORGANIZATION AND BUSINESS OPERATIONS (cont.)

only purchaser and has subscribed for Debentures in the an aggregate principal amount of \$37,959,184 which is convertible into 3,036,735 shares of the Combined Company's common stock and associated warrants for an additional 3,036,735 shares of the Combined Company's common stock. ATW is managed by ATW Partners Opportunities Management, LLC, which is an affiliate of Chardan Capital Markets, LLC ("Chardan"), and our director, Mr. Jonas Grossman, is the Managing Partner and President of Chardan. Chardan will not receive any fees or compensation for ATW's participation in the Debt Financing.

It is anticipated that upon completion of the Business Combination, CLAQ's public stockholders (other than the PIPE Investment investors) would retain an ownership interest of approximately 28.5% in the Combined Company, the PIPE Investment investors will own approximately 5.6% of the Combined Company (such that the public stockholders, including the PIPE Investment investors, would own approximately 34.1% of the Combined Company), the Co-Sponsors, officers, directors and other holders of founder shares will retain an ownership interest of approximately 6.8% of the Combined Company and the Nauticus stockholders will own approximately 59.1% (including the 7,500,000 Earnout Shares) of the Combined Company. The ownership percentage with respect to the Combined Company does not take into account (i) the redemption of any shares by the CLAQ's public stockholders or (ii) the issuance of any additional shares upon the closing of the Business Combination under the 2015 Equity Incentive Plan. If the actual facts are different from these assumptions (which they are likely to be), the percentage ownership retained by the CLAQ stockholders will be different.

The Merger Agreement contains customary representations and warranties of the parties thereto with respect to, among other things, (a) entity organization, good standing and qualification, (b) capital structure, (c) authorization to enter into the Merger Agreement, (d) compliance with laws and permits, (e) taxes, (f) consolidated financial statements and internal controls, (g) real and personal property, (h) material contracts, (i) environmental matters, (j) absence of changes, (k) employee matters, (l) litigation, and (m) brokers and finders.

The Merger Agreement includes customary covenants of the parties with respect to operation of their respective businesses prior to consummation of the Merger and efforts to satisfy conditions to consummation of the Merger. The Merger Agreement also contains additional covenants of the parties, including, among others, covenants providing for CleanTech and Nauticus to use reasonable best efforts to cooperate in the preparation of the Registration Statement and Proxy Statement (as each such term is defined in the Merger Agreement) required to be filed in connection with the Merger and to obtain all requisite approvals of their respective stockholders including, in the case of CleanTech, approvals of the restated certificate of incorporation, the share issuance under Nasdaq rules and the omnibus incentive plan. CleanTech has also agreed to include in the Proxy Statement the recommendation of its board that stockholders approve all of the proposals to be presented at the special meeting.

CleanTech has agreed to approve and adopt a 2022 omnibus incentive plan (the "Incentive Plan") to be effective as of the closing and in a form mutually acceptable to CleanTech and Nauticus. The Incentive Plan shall provide for an initial aggregate share reserve equal to 10% of the number of shares of CleanTech Common Stock on a fully diluted basis at the closing. Subject to approval of the Incentive Plan by CleanTech's stockholders, CleanTech has agreed to file a Form S-8 Registration Statement with the SEC following the Effective Time with respect to the shares of CleanTech Common Stock issuable under the Incentive Plan.

Each of CleanTech and Nauticus has agreed that from the date of the Merger Agreement to the Effective Time or, if earlier, the valid termination of the Merger Agreement in accordance with its terms, it will not initiate any negotiations with any party, or provide non-public information or data concerning it or its subsidiaries to any party relating to an Acquisition Proposal or Alternative Transaction (as such terms are defined in the Merger Agreement) or enter into any agreement relating to such a proposal. Each of CleanTech and Nauticus has also agreed to use its reasonable best efforts to prevent any of its representatives from doing the same.

The consummation of the Merger is conditioned upon, among other things, (i) receipt of the CleanTech stockholder approval and Nauticus stockholder approval, (ii) the expiration or termination of the waiting period under the Hart-Scott-Rodino Antitrust Improvements Act of 1976, as amended, (iii) the absence of any governmental order,

CLEANTECH ACQUISITION CORP.
NOTES TO CONSOLIDATED FINANCIAL STATEMENTS
DECEMBER 31, 2021

NOTE 1. DESCRIPTION OF ORGANIZATION AND BUSINESS OPERATIONS (cont.)

statute, rule or regulation enjoining or prohibiting the consummation of the Transactions, (iv) the effectiveness of the Registration Statement under the Securities Act, (v) CleanTech having at least \$5,000,001 of net tangible assets (as determined in accordance with Rule 3a51-1(g)(1) of the Securities Exchange Act of 1934, as amended (the "Exchange Act")), (vi) solely with respect to CleanTech, (A) the representations and warranties of Nauticus being true and correct to applicable standards applicable and each of the covenants of Nauticus having been performed or complied with in all material respects and (B) the approval of the conversion of the convertible notes and (vii) solely with respect to Nauticus, (A) the representations and warranties of CleanTech being true and correct to applicable standards applicable and each of the covenants of CleanTech having been performed or complied with in all material respects (B) the receipt of the approval for listing by Nasdaq of the shares of CleanTech Common Stock to be issued in connection with the transactions contemplated by the Merger Agreement, (C) the effective resignations of certain directors and executive officers of CleanTech, (D) the amount of Minimum Cash Condition (as defined in the Merger Agreement) being equal to or exceeding \$50,000,000.

Other Agreements

The Business Combination Agreement contemplates the execution of various additional agreements and instruments, on or before the Closing, including, among others, the following:

Support Agreements

In connection with the execution of the Merger Agreement, CleanTech Sponsor I LLC and CleanTech Investments, LLC (each, a "Sponsor," and collectively, the "Co-Sponsors") entered into a support agreement (the "Sponsor Support Agreement") with Nauticus pursuant to which the Sponsors have agreed to vote all shares of CleanTech Common Stock beneficially owned by them in favor of the Merger.

In addition, in connection with the execution of the Merger Agreement, certain stockholders of Nauticus owning approximately 88.8% of the voting power of Nauticus entered into a support agreement (the "Nauticus Support Agreement") with CleanTech and Nauticus pursuant to which the stockholders agreed to vote all shares of Nauticus beneficially owned by them in favor of the Merger.

Subscription Agreements

In connection with the execution of the Merger Agreement, CleanTech entered into subscription agreements (collectively, the "Subscription Agreements") with certain parties subscribing for shares of CleanTech Common Stock (the "Subscribers") pursuant to which the Subscribers have agreed to purchase, and CleanTech has agreed to sell to the Subscribers, an aggregate of 3,530,000 shares of CleanTech Common Stock, for a purchase price of \$10.00 per share and an aggregate purchase price of \$35.3 million. The obligations to consummate the transactions contemplated by the Subscription Agreements are conditioned upon, among other things, customary closing conditions and the consummation of the transactions contemplated by the Merger Agreement.

Securities Purchase Agreement

In connection with the execution of the Merger Agreement, CleanTech and Nauticus entered into Securities Purchase Agreement with certain investors purchasing up to an aggregate of \$40,000,000 in principal amount of Debentures and Warrants. The number of shares of Common Stock into which the Debentures are convertible is equal to 120% of the aggregate issued amount of the Debentures divided by the conversion price of \$15.00, and the number of shares of Common Stock into which the associated Warrants are exercisable is equal to 10% of the outstanding principal amount of the Debentures divided by the conversion price, with an exercise price equal to \$20.00, subject to adjustment ("Debt Financing"). The obligations to consummate the transactions contemplated by the Securities Purchase Agreement are conditioned upon, among other things, customary closing conditions and all conditions precedent to the Merger set forth in the Merger Agreement shall have been satisfied or waived.

CLEANTECH ACQUISITION CORP.
NOTES TO CONSOLIDATED FINANCIAL STATEMENTS
DECEMBER 31, 2021

NOTE 1. DESCRIPTION OF ORGANIZATION AND BUSINESS OPERATIONS (cont.)

Amended and Restated Registration Rights Agreement

In connection with the Closing, Nauticus, CleanTech and certain stockholders of each of Nauticus and CleanTech who will receive shares of CleanTech Common Stock pursuant to the Merger Agreement, will enter into an amended and restated registration rights agreement (“Registration Rights Agreement”) mutually agreeable to CleanTech and Nauticus, which will become effective upon the consummation of the Merger.

Lock-up Agreement and Arrangements

In connection with the Closing, the Sponsors and certain Nauticus stockholders will enter into a lockup agreement (the “Sponsor Lock-Up Agreement” and “Company Stockholder Lock-up Agreement”) with Nauticus and CleanTech, pursuant to which each will agree, subject to certain customary exceptions, not to:

(i) offer, sell, contract to sell, pledge or otherwise dispose of, directly or indirectly, any shares of CleanTech Common Stock received as merger consideration and held by it immediately after the Effective Time (the “Lock-Up Shares”), or enter into a transaction that would have the same effect;

(ii) enter into transaction that would have the same effect, or enter into any swap, hedge or other arrangement that transfers, in whole or in part, any of the economic consequences of ownership of any of such shares, whether any of these transactions are to be settled by delivery of such shares, in cash or otherwise; or

(iii) publicly disclose the intention to make any offer, sale, pledge or disposition, or to enter into any transaction, swap, hedge or other arrangement, or engage in any “Short Sales” (as defined in the Sponsor Lock-Up Agreement and Company Stockholder Lock-up Agreement) with respect to any security of CleanTech; during a “Lock-Up Period” under their respective agreements.

Under the Sponsor Lock-up Agreement, the Lock-Up period means the period commencing on the Closing Date and ending on the earlier of (x) the one year anniversary of the Closing Date; (y) the date on which the volume weighted average price of shares of Common Stock equals or exceeds \$13.00 per share for twenty (20) of any thirty (30) consecutive trading days commencing after the Closing on Nasdaq, and (z) the date specified in a written waiver duly executed by Nauticus; provided that the restrictions set forth in the Sponsor Lock-up Agreement do not apply to (1) transfers or distributions to such stockholder’s current or former general or limited partners, managers or members, stockholders, other equity holders or direct or indirect affiliates (within the meaning of Rule 405 under the Securities Act of 1933, as amended) or to the estates of any of the foregoing; (2) transfers by bona fide gift to a member of the stockholder’s immediate family or to a trust, the beneficiary of which is the stockholder or a member of the stockholder’s immediate family for estate planning purposes; (3) by virtue of the laws of descent and distribution upon death of the stockholder; or (4) pursuant to a qualified domestic relations order, in each case where such transferee agrees to be bound by the terms of the Sponsor Lock-up Agreement.

Under the Company Lock-up Agreement, the Lock-Up period means the period commencing on the Closing Date and ending on the earlier of (x) the date that is 180 calendar days after the consummation of the Business Combination, (y) the date on which the volume weighted average price of shares of Common Stock equals or exceeds \$13.00 per share for twenty (20) of any thirty (30) consecutive trading days commencing after the Closing on Nasdaq, and (z) the date specified in a written waiver duly executed by the Sponsors and CleanTech; provided that the restrictions set forth in the Company Lock-up Agreement do not apply to (1) transfers or distributions to such stockholders current or former general or limited partners, managers or members, stockholders, other equityholders or other direct or indirect affiliates (within the meaning of Rule 405 under the Securities Act of 1933, as amended) or to the estates of any of the foregoing; (2) transfers by bona fide gift to a member of the stockholder’s immediate family or to a trust, the beneficiary of which is the stockholder or a member of the stockholder’s immediate family for estate planning purposes; (3) by virtue of the laws of descent and distribution upon death of the stockholder; (4) pursuant to a qualified domestic relations order, in each case where such transferee agrees to be bound by the terms of this Agreement; (5) transfers or distributions of, or other transactions involving, securities other than the Lock-up Shares (including,

**CLEANTECH ACQUISITION CORP.
NOTES TO CONSOLIDATED FINANCIAL STATEMENTS
DECEMBER 31, 2021**

NOTE 1. DESCRIPTION OF ORGANIZATION AND BUSINESS OPERATIONS (cont.)

without limitation, securities acquired in the PIPE or in open market transactions); or (6) in the case of Angela Berka (or Reginald Berka with respect to any community, marital or similar interest he may have in the following shares), the transfer of up to 1,000,000 shares of Lock-up Shares in a privately negotiated sale to another company stockholder, who shall enter into a Lock-Up Agreement (or amend an existing Lock-Up Agreement) containing the same terms and conditions as this Agreement with respect to such shares, or the entry into any agreement with respect to such a sale entered into before, at or after the Effective Time.

Director Nomination Agreement

In connection with the Closing, CleanTech, the Sponsors and Nauticus will enter into a Director Nomination Agreement (the “Director Nomination Agreement”) pursuant to which CleanTech will agree to nominate an individual designated by the Sponsors to the Board of Directors of the combined company, effective as of immediately prior to the Closing.

Director Designation Agreement

In connection with the execution of the Merger Agreement, CleanTech, Nauticus and certain Nauticus stockholders entered into a director designation agreement with Transocean, Inc. (“Transocean”) to take all necessary action to cause a member designated by Transocean (the “Transocean Designee”) to remain on, or otherwise be appointed to, the Board, from and after the effective time of the Merger, as a Class III member of the Board, for an initial term expiring at the third annual meeting following the date of the Second Amended and Restated Certificate of Incorporation to be adopted in connection with the Merger.

Indemnification Agreements

In connection with the Closing, CleanTech has agreed to enter into customary indemnification agreements, in form and substance reasonably acceptable to CleanTech and Nauticus, with the individuals who will be nominated and, subject to stockholder approval, elected to CleanTech’s board of directors effective as of the Closing.

Going Concern Consideration

As of December 31, 2021, the Company had \$518,905 in cash held outside of the Trust Account and working capital of \$259,136. As a result of the above, in connection with the Company’s assessment of going concern considerations in accordance with Financial Accounting Standard Board’s (“FASB”) Accounting Standards Update (“ASU”) 2014-15, “Disclosures of Uncertainties about an Entity’s Ability to Continue as a Going Concern,” management has determined that the liquidity condition and date for mandatory liquidation and dissolution raise substantial doubt about the Company’s ability to continue as a going concern through July 19, 2022, the scheduled liquidation date of the Company if it does not complete a Business Combination prior to such date. Management plans to address this uncertainty through the Business Combination as discussed above. There is no assurance that the Company’s plans to consummate the Business Combination will be successful or successful within the Combination Period. These consolidated financial statements do not include any adjustments relating to the recovery of the recorded assets or the classification of the liabilities that might be necessary should the Company be unable to continue as a going concern.

Principles of Consolidation

The accompanying consolidated financial statements include the accounts of the Company and its wholly owned subsidiary. All significant intercompany balances and transactions have been eliminated in consolidation.

Risks and Uncertainties

Management continues to evaluate the impact of the COVID-19 pandemic on the industry and has concluded that while it is reasonably possible that the virus could have a negative effect on the Company’s financial position, results of its operations, and/or search for a target company, the specific impact is not readily determinable as of the date of these consolidated financial statements. The consolidated financial statements do not include any adjustments that might result from the outcome of this uncertainty.

CLEANTECH ACQUISITION CORP.
NOTES TO CONSOLIDATED FINANCIAL STATEMENTS
DECEMBER 31, 2021

NOTE 2. SUMMARY OF SIGNIFICANT ACCOUNTING POLICIES

Basis of Presentation

The accompanying consolidated financial statements of the Company are presented in conformity with accounting principles generally accepted in the United States of America (“GAAP”) and pursuant to the rules and regulations of the SEC.

Emerging Growth Company

The Company is an “emerging growth company,” as defined in Section 2(a) of the Securities Act, as modified by the Jumpstart Our Business Startups Act of 2012 (the “JOBS Act”), and it may take advantage of certain exemptions from various reporting requirements that are applicable to other public companies that are not emerging growth companies including, but not limited to, not being required to comply with the auditor attestation requirements of Section 404 of the Sarbanes-Oxley Act, reduced disclosure obligations regarding executive compensation in its periodic reports and proxy statements, and exemptions from the requirements of holding a nonbinding advisory vote on executive compensation and stockholder approval of any golden parachute payments not previously approved.

Further, Section 102(b)(1) of the JOBS Act exempts emerging growth companies from being required to comply with new or revised financial accounting standards until private companies (that is, those that have not had a Securities Act registration statement declared effective or do not have a class of securities registered under the Exchange Act) are required to comply with the new or revised financial accounting standards. The JOBS Act provides that a company can elect to opt out of the extended transition period and comply with the requirements that apply to non-emerging growth companies but any such election to opt out is irrevocable. The Company has elected not to opt out of such extended transition period which means that when a standard is issued or revised and it has different application dates for public or private companies, the Company, as an emerging growth company, can adopt the new or revised standard at the time private companies adopt the new or revised standard. This may make comparison of the Company’s financial statement with another public company which is neither an emerging growth company nor an emerging growth company which has opted out of using the extended transition period difficult or impossible because of the potential differences in accounting standards used.

Use of Estimates

The preparation of consolidated financial statements in conformity with GAAP requires the Company’s management to make estimates and assumptions that affect the reported amounts of assets and liabilities and disclosure of contingent assets and liabilities at the date of the consolidated financial statements and the reported amounts of expenses during the reporting periods.

Making estimates requires management to exercise significant judgment. It is at least reasonably possible that the estimate of the effect of a condition, situation or set of circumstances that existed at the date of the consolidated financial statements, which management considered in formulating its estimate, could change in the near term due to one or more future confirming events. One of the more significant accounting estimates included in these consolidated financial statements is the determination of the fair value of the warrant liabilities. Accordingly, the actual results could differ from those estimates.

Cash and Cash Equivalents

The Company considers all short-term investments with an original maturity of three months or less when purchased to be cash equivalents. The Company did not have any cash equivalents as of December 31, 2021 and 2020.

CLEANTECH ACQUISITION CORP.
NOTES TO CONSOLIDATED FINANCIAL STATEMENTS
DECEMBER 31, 2021

NOTE 2. SUMMARY OF SIGNIFICANT ACCOUNTING POLICIES (cont.)**Investments Held in Trust Account**

At December 31, 2021, the assets held in the Trust Account were held in money market funds, which are invested in U.S. Treasury securities. Trading securities are presented on the balance sheet at fair value at the end of each reporting period. Gains and losses resulting from the change in fair value of these securities is included in unrealized gains (losses) on investments held in Trust Account in the accompanying consolidated statements of operations. Interest and dividend income on these securities is included in net gain on investments held in Trust Account in the accompanying consolidated statements of operations.

Common Stock Subject to Possible Redemption

The Company accounts for its Common Stock subject to possible redemption in accordance with the guidance in ASC Topic 480, *Distinguishing Liabilities from Equity*. Common Stock subject to mandatory redemption (if any) is classified as liability instruments and are measured at fair value. Conditionally redeemable Common Stock (including Common Stock that feature redemption rights that are either within the control of the holder or subject to redemption upon occurrence of uncertain events not solely within the Company's control) are classified as temporary equity. At all other times, Common Stock are classified as shareholders' equity. The Company's Common Stock feature certain redemption rights that are considered to be outside of the Company's control and subject to the occurrence of uncertain future events. Accordingly, as of December 31, 2021, 17,250,000 Common Stock subject to possible redemption are presented as temporary equity, outside of the shareholders' equity section of the Company's balance sheet. Effective with the closing of the Initial Public Offering, the Company recognized the accretion from the initial book value to redemption amount, which resulted in charges against additional paid-in capital (to the extent available) and accumulated deficit.

The Company recognizes changes in redemption value immediately as they occur and adjusts the carrying value of redeemable Common Stock to equal the redemption value at the end of each reporting period. This method would view the end of the reporting period as if it were also the redemption date for the security. Increases or decreases in the carrying amount of redeemable Common Stock are affected by charges against additional paid in capital and accumulated deficit.

As of December 31, 2021, the Common Stock reflected in the balance sheet is reconciled in the following table:

Gross proceeds	\$ 172,500,000
Less:	
Proceeds allocated to Public Warrants	(6,037,500)
Proceeds allocated to Public Rights	(3,934,879)
Issuance costs allocated to common stock	(3,672,335)
Plus:	
Accretion of carrying value to redemption value	15,369,714
Common stock subject to possible redemption	\$ 174,225,000

Offering Costs associated with the Initial Public Offering

The Company complies with the requirements of ASC 340-10-S99-1 and SEC Staff Accounting Bulletin Topic 5A — *Expenses of Offering*. Offering costs consist principally of professional and registration fees incurred through the balance sheet date that are related to the Initial Public Offering. Offering costs directly attributable to the issuance of an equity contract to be classified in equity are recorded as a reduction in equity. Offering costs for equity contracts that are classified as assets and liabilities are expensed immediately. The Company incurred offering costs amounting to \$3,916,281 as a result of the Initial Public Offering (consisting of a \$3,450,000 underwriting discount and \$466,281 of other offering costs). The Company recorded \$3,672,335 of offering costs as a reduction of equity in connection with the redeemable Common Stock included in the Units. The Company recorded \$88,910 of offering costs as a reduction of permanent equity in connection with the Rights classified as equity instruments. The Company immediately expensed \$155,037 of offering costs in connection with the Public Warrants and Private Placement Warrants that were classified as liabilities.

CLEANTECH ACQUISITION CORP.
NOTES TO CONSOLIDATED FINANCIAL STATEMENTS
DECEMBER 31, 2021

NOTE 2. SUMMARY OF SIGNIFICANT ACCOUNTING POLICIES (cont.)

Derivative Warrant Liabilities

The Company accounts for warrants as either equity-classified or liability-classified instruments based on an assessment of the warrant's specific terms and applicable authoritative guidance in ASC 480, *Distinguishing Liabilities from Equity* ("ASC 480"), and ASC 815, *Derivatives and Hedging* ("ASC 815"). The assessment considers whether the warrants are freestanding financial instruments pursuant to ASC 480, meet the definition of a liability pursuant to ASC 480, and whether the warrants meet all of the requirements for equity classification under ASC 815, including whether the warrants are indexed to the Company's own Common Stock, among other conditions for equity classification. This assessment, which requires the use of professional judgment, is conducted at the time of warrant issuance and as of each subsequent quarterly period end date while the warrants are outstanding.

For issued or modified warrants that meet all of the criteria for equity classification, the warrants are required to be recorded as a component of additional paid-in capital at the time of issuance. For issued or modified warrants that do not meet all the criteria for equity classification, the warrants are required to be recorded at their initial fair value on the date of issuance, and each balance sheet date thereafter. For the initial valuation, the Company utilized a Monte Carlo simulation model for the initial valuation of the Public Warrants, and the publicly-traded value for the subsequent valuation of the Public Warrants. Changes in the estimated fair value of the warrants are recognized as a non-cash gain or loss on the consolidated statements of operations. The fair value of the Private Placement Warrants was estimated using a Black-Scholes Option Pricing Model (see Note 10). The subsequent measurement of the Public Warrants as of December 31, 2021 is classified as Level 1, as such, an observable market quote in an active market under the ticker CLAQW was used.

The Company evaluates its financial instruments to determine if such instruments are derivatives or contain features that qualify as embedded derivatives in accordance with ASC Topic 815, *Derivatives and Hedging*. For derivative financial instruments that are accounted for as liabilities, the derivative instrument is initially recorded at its fair value on the grant date and is then re-valued at each reporting date, with changes in the fair value reported in the consolidated statements of operations. The classification of derivative instruments, including whether such instruments should be recorded as liabilities or as equity, is evaluated at the end of each reporting period. Derivative liabilities are classified in the balance sheet as current or non-current based on whether or not net-cash settlement or conversion of the instrument could be required within 12 months of the balance sheet date.

Income Taxes

The Company complies with the accounting and reporting requirements of ASC Topic 740, *Income Taxes*, which requires an asset and liability approach to financial accounting and reporting for income taxes. Deferred income tax assets and liabilities are computed for differences between the financial statement and tax bases of assets and liabilities that will result in future taxable or deductible amounts, based on enacted tax laws and rates applicable to the periods in which the differences are expected to affect taxable income. Valuation allowances are established, when necessary, to reduce deferred tax assets to the amount expected to be realized.

ASC 740 prescribes a recognition threshold and a measurement attribute for the financial statement recognition and measurement of tax positions taken or expected to be taken in a tax return. For those benefits to be recognized, a tax position must be more likely than not to be sustained upon examination by taxing authorities. The Company recognizes accrued interest and penalties related to unrecognized tax benefits as income tax expense. There were no unrecognized tax benefits and no amounts accrued for interest and penalties as of December 31, 2021 and December 31, 2020. The Company is currently not aware of any issues under review that could result in significant payments, accruals or material deviation from its position. The Company is subject to income tax examinations by major taxing authorities since inception. The Company has no expectation of a change in the above for a period of time within one year after the date that the consolidated financial statements are issued.

CLEANTECH ACQUISITION CORP.
NOTES TO CONSOLIDATED FINANCIAL STATEMENTS
DECEMBER 31, 2021

NOTE 2. SUMMARY OF SIGNIFICANT ACCOUNTING POLICIES (cont.)**Net Loss Per Share of Common Stock**

Net loss per share of Common Stock is computed by dividing net earnings by the weighted-average number of shares of Common Stock outstanding during the period (for all periods during which these shares were subject to forfeiture, the calculation of weighted average shares outstanding excludes an aggregate of 562,500 shares of Common Stock held by the Sponsor that were subject to forfeiture to the extent that the underwriter's over-allotment was not exercised in full). The Company has not considered the effect of the Warrants sold in the Initial Public Offering and private placement to purchase an aggregate of 15,800,000 shares in the calculation of diluted income per share, since the exercise of the Warrants are contingent upon the occurrence of future events and the inclusion of such Warrants would be anti-dilutive.

The following table reflects the calculation of basic and diluted net loss per share of Common Stock (in dollars, except per share amounts):

	For the year ended December 31, 2021	For the period from June 18, 2020 (inception) through December 31, 2020
Basic and diluted net loss per share:		
Numerator:		
Net loss	\$ (595,442)	\$ (1,000)
Denominator:		
Basic weighted average shares outstanding	11,781,678	3,750,000
Basic net loss per share of Common Stock	\$ (0.05)	\$ (0.00)

Concentration of Credit Risk

Financial instruments that potentially subject the Company to concentrations of credit risk consist of cash accounts in a financial institution, which, at times may exceed the Federal Depository Insurance Corporation coverage limit of \$250,000. The Company has not experienced losses on these accounts and management believes the Company is not exposed to significant risks on such account.

Fair Value of Financial Instruments

The Company applies ASC Topic 820, *Fair Value Measurement* ("ASC 820"), which establishes a framework for measuring fair value and clarifies the definition of fair value within that framework. ASC 820 defines fair value as an exit price, which is the price that would be received for an asset or paid to transfer a liability in the Company's principal or most advantageous market in an orderly transaction between market participants on the measurement date. The fair value hierarchy established in ASC 820 generally requires an entity to maximize the use of observable inputs and minimize the use of unobservable inputs when measuring fair value. Observable inputs reflect the assumptions that market participants would use in pricing the asset or liability and are developed based on market data obtained from sources independent of the reporting entity. Unobservable inputs reflect the entity's own assumptions based on market data and the entity's judgments about the assumptions that market participants would use in pricing the asset or liability and are to be developed based on the best information available in the circumstances.

CLEANTECH ACQUISITION CORP.
NOTES TO CONSOLIDATED FINANCIAL STATEMENTS
DECEMBER 31, 2021

NOTE 2. SUMMARY OF SIGNIFICANT ACCOUNTING POLICIES (cont.)

The carrying amounts reflected in the balance sheet for cash, prepaid expenses and accrued offering costs approximate fair value due to their short-term nature.

Level 1	—	Assets and liabilities with unadjusted, quoted prices listed on active market exchanges. Inputs to the fair value measurement are observable inputs, such as quoted prices in active markets for identical assets or liabilities.
Level 2	—	Inputs to the fair value measurement are determined using prices for recently traded assets and liabilities with similar underlying terms, as well as direct or indirect observable inputs, such as interest rates and yield curves that are observable at commonly quoted intervals.
Level 3	—	Inputs to the fair value measurement are unobservable inputs, such as estimates, assumptions, and valuation techniques when little or no market data exists for the assets or liabilities.

Recent Accounting Standards

In August 2020, the Financial Accounting Standards Board (“FASB”) issued Accounting Standards Update (“ASU”) 2020-06, Debt — Debt with Conversion and Other Options (Subtopic 470-20) and Derivatives and Hedging — Contracts in Entity’s Own Equity (Subtopic 815-40) (“ASU 2020-06”) to simplify accounting for certain financial instruments. ASU 2020-06 eliminates the current models that require separation of beneficial conversion and cash conversion features from convertible instruments and simplifies the derivative scope exception guidance pertaining to equity classification of contracts in an entity’s own equity. The new standard also introduces additional disclosures for convertible debt and freestanding instruments that are indexed to and settled in an entity’s own equity. ASU 2020-06 amends the diluted earnings per share guidance, including the requirement to use the if converted method for all convertible instruments. ASU 2020-06 is effective for the Company on January 1, 2024 and should be applied on a full or modified retrospective basis, with early adoption permitted beginning on January 1, 2021. The Company adopted ASU 2020-06 effective January 1, 2021 using the modified retrospective method of transition. The adoption of ASU 2020-06 did not have a material impact on the consolidated financial statements for the fiscal year ended December 31, 2021.

Management does not believe that any other recently issued, but not yet effective, accounting standards, if currently adopted, would have a material effect on the Company’s consolidated financial statements.

NOTE 3. INITIAL PUBLIC OFFERING

Pursuant to the Initial Public Offering which was consummated on July 19, 2021, the Company sold 15,000,000 Units at a purchase price of \$10.00 per Unit. Each Unit consists of one share of the Company’s Common Stock, \$0.0001 par value, one right entitling the holder thereof to receive one-twentieth (1/20) of one share Common Stock upon the consummation of an initial business combination (the “Rights”), and one-half of one redeemable warrant (“Redeemable Warrant”). Each whole Redeemable Warrant is exercisable to purchase one share of Common Stock and only whole warrants are exercisable. No fractional warrants will be issued upon separation of the Units and only whole warrants will trade. The Redeemable Warrants will become exercisable on the later of 30 days after the completion of the Initial Business Combination or 12 months from the closing of the Initial Public Offering. Each whole Redeemable Warrant entitles the holder to purchase one share of Common Stock at an exercise price of \$11.50 (see Note 7).

On July 26, 2021, the underwriters fully exercised the over-allotment option and purchased an additional 2,250,000 Units (the “Over-Allotment Units”), generating gross proceeds of \$22,500,000 on July 28, 2021.

NOTE 4. PRIVATE PLACEMENT

Simultaneously with the closing of the Initial Public Offering, the Sponsor and Co-Sponsor purchased an aggregate of 6,500,000 Private Warrants at a price of \$1.00 per Private Placement Warrant (\$6,500,000 in the aggregate). Each Private Placement Warrant is exercisable to purchase one share of Common Stock at a price of \$11.50 per share.

CLEANTECH ACQUISITION CORP.
NOTES TO CONSOLIDATED FINANCIAL STATEMENTS
DECEMBER 31, 2021

NOTE 4. PRIVATE PLACEMENT (cont.)

Simultaneously with the sale of Over-Allotment Units, the Company consummated a private sale of an additional 675,000 Private Warrants at a purchase price of \$1.00 per Private Warrant, generating gross proceeds of \$675,000. The proceeds from the sale of the Private Warrants were added to the net proceeds from the Initial Public Offering held in the Trust Account. If the Company does not complete a Business Combination within the Combination Period, the proceeds from the sale of the Private Warrants will be used to fund the redemption of the Public Shares (subject to the requirements of applicable law) and the Private Placement Warrants will expire worthless.

NOTE 5. RELATED PARTY TRANSACTIONS

Founder Shares

In July 2020, the Sponsor was issued 5,000,000 shares of Common Stock (the “Founder Shares”) for an aggregate price of \$25,000. In February 2021, the Company effected a 1.4375-for-1 stock split of its issued and outstanding shares of Common Stock, resulting in an aggregate of 4,312,500 Founder Shares issued and outstanding. The Founder Shares include an aggregate of up to 562,500 shares of Common Stock subject to forfeiture by the Sponsor to the extent that the underwriters’ over-allotment option is not exercised in full or in part, so that the Sponsor will own, on an as-converted basis, 20% of the Company’s issued and outstanding shares after the Initial Public Offering.

On February 16, 2021, CleanTech Sponsor paid \$16,667 to the Company, which amount was paid to CleanTech Investments LLC to cancel 4,791,667 of its Founder Shares that it previously held and immediately thereafter the Company issued 4,791,667 Founders Shares to CleanTech Sponsor. As a result, CleanTech Sponsor owns 4,791,667 Founders Shares and CleanTech Investments LLC owns 2,395,833 Founder Shares. CleanTech Sponsor and CleanTech Investments LLC will both participate in the purchase of the Private Warrants based their pro rata ownership of Founder Shares.

In June 2021, CleanTech Sponsor and CleanTech Investments forfeited for no consideration 1,916,667 founder shares and 958,333 founder shares, respectively, which the Company cancelled, resulting in a decrease in the total number of founder shares outstanding from 7,187,500 shares to 4,312,500 shares. As a result, CleanTech Sponsor owns 2,875,000 founder shares and CleanTech Investments owns 1,437,500 founder shares. The founder shares include an aggregate of up to 562,500 shares that are subject to forfeiture to the extent that the underwriters’ over-allotment option is not exercised in full or in part. All share and per-share amounts have been retroactively restated to reflect the share forfeiture.

The underwriter exercised the over-allotment option on in full July 28, 2021; thus, no Founders Shares are subject to forfeiture.

Administrative Services Agreement

The Company entered into an agreement, commencing on the July 14, 2021, to pay Chardan Capital Markets, LLC up to \$10,000 per month for office space, administrative and support services. The total amounts of administrative service fees incurred and outstanding for the year ended December 31, 2021 were \$53,333. Upon completion of the Business Combination or the Company’s liquidation, the Company will cease paying these monthly fees.

Promissory Note — Related Party

On March 1, 2021, the Company issued an unsecured promissory note to the Sponsor (the “Promissory Note”), pursuant to which the Company could borrow an aggregate of up to \$250,000 to cover expenses related to the Initial Public Offering. The Promissory Note was non-interest bearing and is payable on the earlier of Promptly after the date on which the Maker consummates an initial public offering of its securities or (ii) the completion of the Initial Public Offering. The outstanding balance under the Promissory Note of \$188,302 was repaid on July 23, 2021. The promissory note is no longer available to the Company.

CLEANTECH ACQUISITION CORP.
NOTES TO CONSOLIDATED FINANCIAL STATEMENTS
DECEMBER 31, 2021

NOTE 5. RELATED PARTY TRANSACTIONS (cont.)

Related Party Loans

In addition, in order to finance transaction costs in connection with an intended initial Business Combination, the Company's Sponsor, Co-Sponsor, or an affiliate of the Sponsor or the officers and directors may, but are not obligated to, loan the Company funds as may be required. If the Company consummates the initial Business Combination, it would repay such loaned amounts. The notes would either be paid upon consummation of the Company's initial Business Combination, without interest, or, at the lender's discretion, up to \$500,000 of the notes may be converted upon consummation of the Business Combination into additional private warrants to purchase shares of Common Stock at a conversion price of \$1.00 per private warrant (which, for example, would result in the holders being issued private warrants to purchase 500,000 shares of Common Stock if \$500,000 of notes were so converted). Such private warrants will be identical to the private warrants to be issued at the closing of the initial public offering. Loans made by Chardan Capital Markets, LLC or any of its related persons will not be convertible into private warrants, and Chardan Capital Markets, LLC and its related persons will have no recourse with respect to their ability to convert their loans into private warrants. As of December 31, 2021 and December 31, 2020, there were no borrowings under these loans.

Related Party Extension Loans

The Company may extend the period of time to consummate a Business Combination up to two times, each by an additional three months (for a total of 18 months to complete a Business Combination). In order to extend the time available for the Company to consummate a Business Combination, without the need for a separate stockholder vote, is for the Company's initial stockholders or their affiliates or designees, upon five days' advance notice prior to the application deadline, to deposit into the trust account \$1,500,000 or \$1,725,000 if the underwriters' over-allotment option is exercised in full (\$0.10 per public share, or an aggregate of \$3,000,000 (or \$3,450,000 if the over-allotment option is exercised in full) if extended for each of the full three months), on or prior to the date of the application deadline. In the event that the stockholders, or affiliates or designees, elect to extend the time to complete the Company's initial business combination and deposit the applicable amount of money into trust, the initial stockholders will receive a non-interest bearing, unsecured promissory note equal to the amount of any such deposit that will not be repaid in the event that the Company is unable to close a business combination unless there are funds available outside the trust account to do so. Such note would be paid upon consummation of the Company's initial Business Combination.

NOTE 6. COMMITMENTS

Registration and Stockholder Rights Agreement

Pursuit to a registration rights agreement entered into on July 14, 2021, the holders of insider shares issued and outstanding, as well as the holders of the private warrants (and all underlying securities), will be entitled to registration and stockholder rights pursuant to an agreement to be signed prior to or on the effective date of the initial public offering. The holders of a majority of these securities are entitled to make up to two demands that the Company registers such securities. The holders of the majority of the insider shares can elect to exercise these registration rights at any time commencing three months prior to the date on which these shares of Common Stock are to be released from escrow. In addition, the holders have certain "piggy-back" registration rights with respect to registration statements filed subsequent to the consummation of a Business Combination. The Company will bear the expenses incurred in connection with the filing of any such registration statements.

Underwriter's Agreement

The Company granted the underwriter a 45-day option to purchase up to 2,250,000 additional Units to cover over-allotments at the Initial Public Offering price, less the underwriting discounts and commissions. On July 28, 2021, the Underwriters exercised the over-allotment option in full and purchased an additional 2,250,000 Units for an aggregate purchase price of \$22,500,000.

CLEANTECH ACQUISITION CORP.
NOTES TO CONSOLIDATED FINANCIAL STATEMENTS
DECEMBER 31, 2021

NOTE 6. COMMITMENTS (cont.)

In connection with the closing of the Initial Public Offering and subsequent exercise of the over-allotment option, the underwriter was paid a cash underwriting fee of \$0.20 per Unit, or \$3,450,000 in the aggregate.

Business Combination Marketing Agreement

The Company engaged Chardan Capital Markets, LLC as an advisor in connection with the initial Business Combination to assist the Company in holding meetings with the stockholders to discuss the potential Business Combination and the target business's attributes, introduce the Company to potential investors that are interested in purchasing the securities in connection with the potential Business Combination, assist the Company in obtaining stockholder approval for the Business Combination and assist the Company with press releases and public filings in connection with the Business Combination. The Company will pay Chardan Capital Markets, LLC a marketing fee for such services upon the consummation of the initial Business Combination in an amount equal to, in the aggregate, 3.5% of the gross proceeds of the initial public offering, including any proceeds from the full or partial exercise of the underwriters' over-allotment option. As a result, Chardan Capital Markets, LLC will not be entitled to such fee unless the Company consummates the initial Business Combination. A copy of the form of Business Combination marketing agreement has been filed as an exhibit to the registration statement of which the Company's prospectus forms a part.

NOTE 7. WARRANTS

As of December 31, 2021 and December 31, 2020, there were 15,800,000 (including 8,625,000 Public Warrants and 7,175,000 Private Placement Warrants) and no warrants outstanding, respectively.

Each whole public warrant entitles the registered holder to purchase one share of Common Stock at a price of \$11.50 per whole share, subject to adjustment as described below, at any time commencing on the later of one year after the closing of the initial public offering or the consummation of an initial Business Combination. However, no public warrants will be exercisable for cash unless the Company has an effective and current registration statement covering the shares of Common Stock issuable upon exercise of the warrants and a current prospectus relating to such shares of Common Stock. Notwithstanding the foregoing, if a registration statement covering the shares of Common Stock issuable upon exercise of the public warrants is not effective within 120 days from the closing of the initial Business Combination, warrant holders may, until such time as there is an effective registration statement and during any period when the Company shall have failed to maintain an effective registration statement, exercise warrants on a cashless basis pursuant to an available exemption from registration under the Securities Act. The warrants will expire five years from the closing of the initial Business Combination at 5:00 p.m., New York City time.

The private warrants will be identical to the public warrants underlying the units being offered by the Company's prospectus except that (i) each private warrant is exercisable for one share of Common Stock at an exercise price of \$11.50 per share, and (ii) such private warrants will be exercisable for cash (even if a registration statement covering the shares of Common Stock issuable upon exercise of such warrants is not effective) or on a cashless basis, at the holder's option, and will not be redeemable by us, in each case so long as they are still held by the initial purchasers or their affiliates. The private warrants purchased by CleanTech Investments will not be exercisable more than five years from the effective date of the registration statement, of which the Company's prospectus forms a part, in accordance with FINRA Rule 5110(g)(8), as long as Chardan Capital Markets, LLC or any of its related persons beneficially own these private warrants.

The Company may call the outstanding warrants for redemption (excluding the private warrants but including any warrants already issued upon exercise of the unit purchase option), in whole and not in part, at a price of \$0.01 per warrant:

- at any time while the warrants are exercisable,
- upon not less than 30 days' prior written notice of redemption to each warrant holder,

CLEANTECH ACQUISITION CORP.
NOTES TO CONSOLIDATED FINANCIAL STATEMENTS
DECEMBER 31, 2021

NOTE 7. WARRANTS (cont.)

- if, and only if, the reported last sale price of the shares of Common Stock equals or exceeds \$16.50 per share, for any 20 trading days within a 30-day trading period ending on the third business day prior to the notice of redemption to warrant holders, and
- if, and only if, there is a current registration statement in effect with respect to the shares of Common Stock underlying such warrants at the time of redemption and for the entire 30-day trading period referred to above and continuing each day thereafter until the date of redemption.

The right to exercise will be forfeited unless the warrants are exercised prior to the date specified in the notice of redemption. On and after the redemption date, a record holder of a warrant will have no further rights except to receive the redemption price for such holder's warrant upon surrender of such warrant.

If the Company calls the warrants for redemption as described above, the Company's management will have the option to require all holders that wish to exercise warrants to do so on a "cashless basis." In such event, each holder would pay the exercise price by surrendering the warrants for that number of shares of Common Stock equal to the quotient obtained by dividing (x) the product of the number of shares of Common Stock underlying the warrants, multiplied by the difference between the exercise price of the warrants and the "fair market value" by (y) the fair market value. The "fair market value" shall mean the average reported last sale price of the Company's Common Stock for the 10 trading days ending on the third trading day prior to the date on which the notice of redemption is sent to the holders of warrants. Whether the Company will exercise the option to require all holders to exercise their warrants on a "cashless basis" will depend on a variety of factors including the price of the common shares at the time the warrants are called for redemption, the Company's cash needs at such time and concerns regarding dilutive share issuances.

The exercise price and number of shares of Common Stock issuable on exercise of the warrants may be adjusted in certain circumstances including in the event of a share dividend, extraordinary dividend or the Company's recapitalization, reorganization, merger or consolidation. In addition, if the Company issues additional shares of Common Stock or equity-linked securities for capital raising purposes in connection with the closing of the initial Business Combination at a newly issued price of less than \$9.20 per share of Common Stock (with such issue price or effective issue price to be determined in good faith by the board of directors and, in the case of any such issuance to the Company's initial stockholders or their affiliates, without taking into account any founder shares or private warrants held by them, as applicable, prior to such issuance), the exercise price of the warrants will be adjusted (to the nearest cent) to be equal to 115% of the newly issued price and the \$16.50 per share redemption trigger price described below under will be adjusted (to the nearest cent) to be equal to 165% of the market value (the volume weighted average trading price of the Common Stock during the 20 trading day period starting on the trading day prior to the consummation of an initial Business Combination).

The warrants may be exercised upon surrender of the warrant certificate on or prior to the expiration date at the offices of the warrant agent, with the exercise form on the reverse side of the warrant certificate completed and executed as indicated, accompanied by full payment of the exercise price, by certified or official bank check payable to us, for the number of warrants being exercised. The warrant holders do not have the rights or privileges of holders of shares of Common Stock and any voting rights until they exercise their warrants and receive shares of Common Stock. After the issuance of shares of Common Stock upon exercise of the warrants, each holder will be entitled to one vote for each share held of record on all matters to be voted on by stockholders.

Except as described above, no public warrants will be exercisable for cash, and the Company will not be obligated to issue shares of Common Stock unless at the time a holder seeks to exercise such warrant, a prospectus relating to the shares of Common Stock issuable upon exercise of the warrants is current and the shares of Common Stock have been registered or qualified or deemed to be exempt under the securities laws of the state of residence of the holder of the warrants. Under the terms of the warrant agreement, the Company has agreed to use best efforts to meet these conditions and to maintain a current prospectus relating to the shares of Common Stock issuable upon exercise of the warrants until the expiration of the warrants. However, the Company cannot assure you that it will be able to do so and, if the Company does not maintain a current prospectus relating to the shares of Common Stock issuable upon exercise of

CLEANTECH ACQUISITION CORP.
NOTES TO CONSOLIDATED FINANCIAL STATEMENTS
DECEMBER 31, 2021

NOTE 7. WARRANTS (cont.)

the warrants, holders will be unable to exercise their warrants, and the Company will not be required to settle any such warrant exercise. If the prospectus relating to the shares of Common Stock issuable upon the exercise of the warrants is not current or if the Common Stock is not qualified or exempt from qualification in the jurisdictions in which the holders of the warrants reside, the Company will not be required to net cash settle or cash settle the warrant exercise, the warrants may have no value, the market for the warrants may be limited, and the warrants may expire worthless.

No fractional shares will be issued upon exercise of the warrants. If, upon exercise of the warrants, a holder would be entitled to receive a fractional interest in a share, the Company will, upon exercise, round down to the nearest whole number the number of shares of Common Stock to be issued to the warrant holder.

The Company accounts for the 15,800,000 warrants issued in connection with the Initial Public Offering in accordance with the guidance contained in ASC 815-40. Such guidance provides that because the warrants do not meet the criteria for equity treatment thereunder, each warrant must be recorded as a liability.

The accounting treatment of derivative financial instruments required that the Company record the warrants as derivative liabilities at fair value upon the closing of the Initial Public Offering. The Public Warrants were allocated a portion of the proceeds from the issuance of the Units equal to its fair value. This warrant liabilities are subject to re-measurement at each balance sheet date. With each such re-measurement, the warrant liability will be adjusted to its current fair value, with the change in fair value recognized in the Company's statement of operations. The Company will reassess the classification at each balance sheet date. If the classification changes as a result of events during the period, the warrants will be reclassified as of the date of the event that causes the reclassification.

NOTE 8. STOCKHOLDERS' EQUITY (DEFICIT)

Preferred stock — The Company is authorized to issue 1,000,000 shares of \$0.0001 par value preferred stock. As of December 31, 2021 and December 31, 2020, there were no shares of preferred stock issued or outstanding.

Common Stock — On July 16, 2021, the Company amended its Amended and Restated Certificate of Incorporation such that the Company is authorized to issue 200,000,000 shares of Common Stock with a par value of \$0.0001 per share. As of December 31, 2021, there were 21,562,500 shares of Common Stock outstanding, including 17,250,000 Common Stock subject to possible redemption. Of the 21,562,500 shares of Common Stock outstanding, up to 562,500 shares were subject to forfeiture to the Company by the Sponsor for no consideration to the extent that the underwriters' over-allotment option was not exercised in full or in part, so that the initial stockholders will collectively own 20% of the Company's issued and outstanding Common Stock after the initial public offering. The underwriters exercised the over-allotment option in full on July 28, 2021; thus, no shares of Common Stock remain subject to forfeiture.

Holders of record of Common Stock are entitled to one vote for each share held on all matters to be voted on by stockholders. In connection with any vote held to approve the initial Business Combination, insiders, officers and directors, have agreed to vote their respective shares of Common Stock owned by them immediately prior to the initial public offering, including both the insider shares and any shares acquired in the initial public offering or following the initial public offering in the open market, in favor of the proposed Business Combination.

Rights — Except in cases where the Company is not the surviving company in a Business Combination, each holder of a right will automatically receive one-twentieth (1/20) of a share of Common Stock upon consummation of the Business Combination, even if the holder of a right converted all shares held by him, her or it in connection with the Business Combination or an amendment to the Company's Certificate of Incorporation with respect to its pre-business combination activities. In the event that the Company will not be the surviving company upon completion of the Business Combination, each holder of a right will be required to affirmatively convert his, her or its rights in order to receive the one-twentieth (1/20) of a share of Common Stock underlying each right upon consummation of the Business Combination. No additional consideration will be required to be paid by a holder of rights in order to receive his, her or its additional share of Common Stock upon consummation of the Business Combination. The shares

CLEANTECH ACQUISITION CORP.
NOTES TO CONSOLIDATED FINANCIAL STATEMENTS
DECEMBER 31, 2021

NOTE 8. STOCKHOLDERS' EQUITY (DEFICIT) (cont.)

issuable upon exchange of the rights will be freely tradable (except to the extent held by affiliates of the Company). If the Company enters into a definitive agreement for a Business Combination in which the Company will not be the surviving entity, the definitive agreement will provide for the holders of rights to receive the same per share consideration the holders of shares of Common Stock will receive in the transaction on an as-converted into Common Stock basis.

The Company will not issue fractional shares in connection with an exchange of rights. As a result, the holders of the rights must hold rights in multiples of 20 in order to receive shares for all of the holders' rights upon closing of a Business Combination. If the Company is unable to complete an initial Business Combination within the required time period and the Company liquidates the funds held in the Trust Account, holders of rights will not receive any of such funds with respect to their rights, nor will they receive any distribution from the Company's assets held outside of the Trust Account with respect to such rights, and the rights will expire worthless. Additionally, in no event will the Company be required to net cash settle the rights. Accordingly, the rights may expire worthless.

NOTE 9. INCOME TAX

The Company's net deferred tax assets (liabilities) as of December 31, 2021 is as follows:

Deferred tax assets:	
Start-up costs	\$ 252,290
Net operating loss carryforwards	20,412
Total deferred tax assets	272,702
Valuation allowance	(271,562)
Deferred tax liabilities:	
Unrealized gain on investments	(1,140)
Total deferred tax liabilities	(1,140)
Deferred tax assets, net of allowance	\$ —

The income tax provision for the year ended December 31, 2021 consists of the following:

Federal	
Current	\$ —
Deferred	(271,562)
State	
Current	—
Deferred	—
Change in valuation allowance	271,562
Income tax provision	\$ —

As of December 31, 2021, the Company has available U.S. federal operating loss carry forwards of approximately \$990,823 that may be carried forward indefinitely.

In assessing the realization of deferred tax assets, management considers whether it is more likely than not that some portion or all of the deferred tax assets will not be realized. The ultimate realization of deferred tax assets is dependent upon the generation of future taxable income during the periods in which temporary differences representing future deductible amounts become deductible. Management considers the scheduled reversal of deferred tax assets, projected future taxable income and tax planning strategies in making this assessment. After consideration of all the information available, management believes that significant uncertainty exists with respect to future realization of the deferred tax assets and has therefore established a full valuation allowance. For the year ended December 31, 2021, the valuation allowance was \$271,562.

CLEANTECH ACQUISITION CORP.
NOTES TO CONSOLIDATED FINANCIAL STATEMENTS
DECEMBER 31, 2021

NOTE 9. INCOME TAX (cont.)

A reconciliation of the federal income tax rate to the Company's effective tax rate at December 31, 2021 is as follows:

Statutory federal income tax rate	21.0%
State taxes, net of federal tax benefit	0.0%
Change in fair value of derivative warrant liabilities	61.1%
Non-deductible transaction costs	(8.8)%
Change in valuation allowance	(73.3)%
Income tax provision	<u>0.0%</u>

Deferred tax assets were deemed to be de minimis as of December 31, 2020.

NOTE 10. FAIR VALUE MEASUREMENTS

The following table presents information about the Company's financial assets and liabilities that are measured at fair value on a recurring basis as of December 31, 2021 and December 31, 2020, and indicates the fair value hierarchy of the valuation inputs the Company utilized to determine such fair value:

Description	Amount at Fair Value	Level 1	Level 2	Level 3
December 31, 2021				
Assets				
Investments held in Trust Account:				
Money Market investments	\$ 174,230,428	\$ 174,230,428	\$ —	\$ —
Liabilities				
Warrant liabilities – Public Warrants	\$ 5,175,000	\$ 5,175,000	\$ —	\$ —
Warrant liabilities – Private Placement Warrants	\$ 2,798,250	\$ —	\$ —	\$ 2,798,250

The Company did not have any assets or liabilities measured at fair value as of December 31, 2020.

The Company utilized a Monte Carlo simulation model for the initial valuation of the Public Warrants, and the publicly-traded value for the subsequent valuation of the Public Warrants. The measurement of the Public Warrants as of December 31, 2021 is classified as Level 1 due to the use of an observable market quote in an active market under the ticker CLAQW. The quoted price of the Public Warrants was \$0.60 per warrant as of December 31, 2021.

The Company utilizes a Black-Scholes Option Pricing Model to value the Private Placement Warrants at each reporting period, with changes in fair value recognized in the statement of operations. The estimated fair value of the warrant liability is determined using Level 3 inputs. Inherent in a Black-Scholes Option Pricing Model are assumptions related to expected share-price volatility, expected life, risk-free interest rate and dividend yield. For the initial valuation, the Company estimated volatility based on research on comparable companies with the same type of warrants along with the implied volatilities shortly after they start trading. Significant increases (decreases) in the expected volatility in isolation would result in a significantly higher (lower) fair value measurement. The risk-free interest rate is based on the U.S. Treasury zero-coupon yield curve on the grant date for a maturity similar to the expected remaining life of the warrants. The expected life of the warrants is assumed to be equivalent to their remaining contractual term. The dividend rate is based on the historical rate, which the Company anticipates to remain at zero.

Transfers to/from Levels 1, 2 and 3 are recognized at the end of the reporting period. The estimated fair value of the Public Warrants transferred from a Level 3 measurement to a Level 1 fair value measurement in September 2021 after the Public Warrants were separately listed and traded.

CLEANTECH ACQUISITION CORP.
NOTES TO CONSOLIDATED FINANCIAL STATEMENTS
DECEMBER 31, 2021

NOTE 10. FAIR VALUE MEASUREMENTS (cont.)

The following table provides the significant inputs to the Black-Scholes Option Pricing Model fair value of the Private Placement Warrants:

	As of December 31, 2021
Stock price	\$ 9.96
Strike price	\$ 11.50
Probability of completing a Business Combination	100.0%
Dividend yield	—%
Term (in years)	4.6
Volatility	8.7%
Risk-free rate	1.2%
Fair value of warrants	\$ 0.39

The following table provides a summary of the changes in the fair value of the Company's Level 3 financial instruments that are measured at fair value on a recurring basis:

Fair value as of December 31, 2020	\$ —
Initial measurement of Public Warrants and Private Placement Warrants at July 19, 2021	7,980,000
Initial measurement of over-allotment warrants	1,071,000
Transfer of Public Warrants to Level 1 measurement	(5,175,000)
Change in fair value	(1,077,750)
Fair value as of December 31, 2021	\$ 2,798,250

The Company recognized gains in connection with the change in the fair value of warrant liabilities of \$1,077,750 in the consolidated financial consolidated statements of operations during the year ended December 31, 2021.

NOTE 11. SUBSEQUENT EVENTS

The Company evaluated subsequent events and transactions that occurred after the balance sheet date up to the date that the consolidated financial statements were issued. Based upon this review, other than Amendment No. 1 to the Merger Agreement, as described in Note 1, and those items disclosed below, the Company did not identify any subsequent events that would have required adjustment or disclosure in the consolidated financial statements.

On February 11, 2022, the Company entered into an agreement with an investment bank (the "A Capital Markets Advisor") for advisory services such as analyzing, structuring, negotiating, and effecting the potential Business Combination. In exchange for such services, the Company will pay the A Capital Markets Advisor a cash advisory fee of \$350,000 which is payable upon the closing of the potential Business Combination, or six months following the termination of the agreement.

On February 28, 2022, the Company entered into an agreement with an investment bank (the "B Capital Markets Advisor") for advisory services such as capital raising strategies and alternatives, review of business model and financial conditions, and non-deal investor roadshow services related to the potential Business Combination. In exchange for such services, B Capital Markets Advisor is due a non-refundable retainer \$350,000 that is due within ten days following the closing of the potential Business Combination which will be paid by Nauticus.

On March 23, 2022, the Company entered into a Promissory Note with the Sponsor (the "Promissory Note") to which the Company could borrow up to an aggregate of \$267,000. The Promissory Note is non-interest bearing and payable upon the earlier of (i) completion of the initial Business Combination or (ii) the date on which the Company determines that it is unable to effect a Business Combination. On March 23, 2022, the Company drew down \$267,000 under the Promissory Note.

**CLEANTECH ACQUISITION CORP.
CONDENSED BALANCE SHEETS**

	March 31, 2022	December 31, 2021
(Unaudited)		
ASSETS		
Cash	\$ 296,381	\$ 518,905
Prepaid expenses	44,991	73,865
Total current assets	341,372	592,770
Investments held in Trust Account	174,247,973	174,230,428
Total Assets	\$ 174,589,345	\$ 174,823,198
LIABILITIES, COMMON STOCK SUBJECT TO POSSIBLE REDEMPTION AND STOCKHOLDERS' DEFICIT		
Current liabilities:		
Accounts payable	\$ 178,311	\$ 153,601
Accrued expenses	9,000	29,500
Accrued expenses – related party	83,333	53,333
Franchise tax payable	23,967	97,200
Promissory note – related party	267,000	—
Total current liabilities	561,611	333,634
Warrant liabilities	5,559,750	7,973,250
Total Liabilities	6,121,361	8,306,884
Commitments and Contingencies		
Common stock subject to possible redemption, \$0.0001 par value; 17,250,000 shares issued and outstanding at redemption value of \$10.10 per share at March 31, 2022 and December 31, 2021	174,225,000	174,225,000
Stockholders' Deficit		
Preferred stock, \$0.0001 par value; 1,000,000 shares authorized; 0 shares issued and outstanding at March 31, 2022 and December 31, 2021	—	—
Common stock, \$0.0001 par value; 200,000,000 shares authorized; 4,312,500 shares issued and outstanding (excluding 17,250,000 shares subject to possible redemption) at March 31, 2022 and December 31, 2021	431	431
Additional paid-in capital	—	—
Accumulated deficit	(5,757,447)	(7,709,117)
Total Stockholders' Deficit	(5,757,016)	(7,708,686)
TOTAL LIABILITIES, COMMON STOCK SUBJECT TO POSSIBLE REDEMPTION AND STOCKHOLDERS' DEFICIT	\$ 174,589,345	\$ 174,823,198

The accompanying notes are an integral part of the unaudited condensed consolidated financial statements.

CLEANTECH ACQUISITION CORP.
CONDENSED CONSOLIDATED STATEMENTS OF OPERATIONS
(UNAUDITED)

	For the Three Months Ended March 31,	
	2022	2021
Operating costs	\$ 458,647	\$ —
Franchise tax expense	20,728	—
Loss from operations	(479,375)	—
Net gain on investments held in Trust Account	17,545	—
Change in fair value of warrant liabilities	2,413,500	—
Net income	\$ 1,951,670	\$ —
Basic and diluted weighted average shares outstanding	21,562,500	4,312,500
Basic net income per share of common stock	\$ 0.09	\$ 0.00

The accompanying notes are an integral part of the unaudited condensed consolidated financial statements.

CLEANTECH ACQUISITION CORP.
CONDENSED CONSOLIDATED STATEMENTS OF CHANGES IN STOCKHOLDERS' EQUITY
(DEFICIT)
FOR THE THREE MONTHS ENDED MARCH 31, 2022 AND MARCH 31, 2021

	Common Stock		Additional Paid-in Capital	Accumulated Deficit	Total Stockholders' Equity
	Shares	Amount			
Balance at December 31, 2020	4,312,500	\$ 431	\$ 24,281	\$ (1,000)	\$ 23,712
Net income	—	—	—	—	—
Balance – March 31, 2021 (unaudited)	4,312,500	\$ 431	\$ 24,281	\$ (1,000)	\$ 23,712

	Common Stock		Additional Paid-in Capital	Accumulated Deficit	Total Stockholders' Deficit
	Shares	Amount			
Balance at December 31, 2021	4,312,500	\$ 431	\$ —	\$ (7,709,117)	\$ (7,708,686)
Net income	—	—	—	1,951,670	1,951,670
Balance – March 31, 2022 (unaudited)	4,312,500	\$ 431	\$ —	\$ (5,757,447)	\$ (5,757,016)

The accompanying notes are an integral part of the unaudited condensed consolidated financial statements.

CLEANTECH ACQUISITION CORP.
CONDENSED CONSOLIDATED STATEMENTS OF CASH FLOWS
(UNAUDITED)

	For the Three Months Ended March 31,	
	2022	2021
Cash Flows from Operating Activities:		
Net income	\$ 1,951,670	\$ —
Adjustments to reconcile net income to net cash used in operations:		
Net gain on investments held in Trust Account	(17,545)	—
Change in fair value of warrant liabilities	(2,413,500)	—
Changes in operating assets and liabilities:		
Prepaid expenses	28,874	—
Accounts payable	24,710	—
Accrued expenses	(20,500)	—
Accrued expenses – related party	30,000	—
Franchise tax payable	(73,233)	—
Net cash used in operating activities	\$ (489,524)	\$ —
Cash Flows from Financing Activities:		
Proceeds from promissory note – related party	267,000	—
Net cash provided by financing activities	267,000	—
Net Change in Cash	(222,524)	—
Cash – Beginning of period	518,905	25,000
Cash – End of period	\$ 296,381	\$ 25,000
Non-cash investing and financing activities:		
Deferred offering costs included in accrued offering costs	\$ —	\$ 128,165

The accompanying notes are an integral part of the unaudited condensed consolidated financial statements.

CLEANTECH ACQUISITION CORP.
NOTES TO CONDENSED CONSOLIDATED FINANCIAL STATEMENTS
MARCH 31, 2022
(UNAUDITED)

NOTE 1. DESCRIPTION OF ORGANIZATION AND BUSINESS OPERATIONS

CleanTech Acquisition Corp. (the “Company”) is a blank check company incorporated in Delaware on June 18, 2020. The Company was formed for the purpose of entering into a merger, share exchange, asset acquisition, share purchase, reorganization or similar business combination with one or more businesses or entities (a “Business Combination”). The Company is not limited to a particular industry or geographic region for purposes of consummating a Business Combination. The Company is an early stage and emerging growth company and, as such, the Company is subject to all of the risks associated with early stage and emerging growth companies.

As of March 31, 2022, the Company had not commenced any operations. All activity for the three month periods ended March 31, 2022 and March 31, 2021 relates to the Company’s formation and the initial public offering (“Initial Public Offering”), which is described below. The Company will not generate any operating revenues until after the completion of a Business Combination, at the earliest. The Company generates non-operating income in the form of interest income from the proceeds derived from the Initial Public Offering.

The registration statement for the Company’s Initial Public Offering was declared effective on July 14, 2021. On July 19, 2021, the Company consummated the Initial Public Offering of 15,000,000 units (the “Units” and, with respect to the shares of common stock included in the Units sold, the “Public Shares”), at \$10.00 per unit, generating gross proceeds of \$150,000,000, which is discussed in Note 3.

Simultaneously with the closing of the Initial Public Offering, the Company consummated the sale of 4,333,333 warrants at a price of \$1.00 per Private Placement Warrant in a private placement to CleanTech Sponsor (the “Sponsor”), and 2,166,667 warrants (together, the “Private Placement Warrants”) at a price of \$1.00 per Private Placement Warrant in a private placement to CleanTech Investments, an affiliate of the Sponsor (the “Co-sponsor”), generating gross proceeds of 6,500,000, which is described in Note 4.

The Company granted the underwriters in the Initial Public Offering (the “Underwriters”) a 45-day option to purchase up to 2,250,000 additional Units to cover over-allotments, if any. On July 28, 2021, the Underwriters exercised the over-allotment option in full and purchased an additional 2,250,000 units (the “Over-Allotment Units”), generating gross proceeds of \$22,500,000.

Simultaneously with the closing of the exercise of the over-allotment option, the Company consummated the sale of 675,000 warrants (the “Over-Allotment Warrants”) at a purchase price of \$1.00 per warrant in a private placement to the Sponsor, generating gross proceeds of \$675,000.

Following the closing of the Initial Public Offering and the over-allotment, an amount of \$174,225,000 from the net proceeds of the sale of the Public Units in the Initial Public Offering and the sale of the Private Warrants was placed in a trust account (the “Trust Account”), and is invested only in U.S. government treasury obligations with maturities of 183 days or less or in money market funds meeting certain conditions under Rule 2a-7 under the Investment Company Act of 1940, as amended (the “Investment Company Act”) which invest only in direct U.S. government treasury obligations, until the earlier of: (i) the completion of a Business Combination and (ii) the distribution of the funds held in the Trust Account, as described below.

The Company’s management has broad discretion with respect to the specific application of the net proceeds of the Initial Public Offering and the sale of the Private Placement Warrants, although substantially all of the net proceeds are intended to be applied generally toward consummating a Business Combination. There is no assurance that the Company will be able to complete a Business Combination successfully. The Company must complete a Business Combination with one or more target businesses that together have an aggregate fair market value of at least 80% of the value of the Trust Account (as defined below) (excluding the deferred underwriting commissions and taxes payable on income earned on the Trust Account) at the time of the agreement to enter into an initial Business Combination. The Company will only complete a Business Combination if the post-transaction company owns or acquires 50% or more of the outstanding voting securities of the target or otherwise acquires a controlling interest in the target sufficient for it not to be required to register as an investment company under the Investment Company Act.

CLEANTECH ACQUISITION CORP.
NOTES TO CONDENSED CONSOLIDATED FINANCIAL STATEMENTS
MARCH 31, 2022
(UNAUDITED)

NOTE 1. DESCRIPTION OF ORGANIZATION AND BUSINESS OPERATIONS (cont.)

The Company, after signing a definitive agreement for an Initial Business Combination, will either (i) seek stockholder approval of the Initial Business Combination at a meeting called for such purpose in connection with which stockholders may seek to redeem their shares, regardless of whether they vote for or against the Initial Business Combination, for cash equal to their pro rata share of the aggregate amount then on deposit in the Trust Account as of two business days prior to the consummation of the Initial Business Combination, including interest but less taxes payable, or (ii) provide stockholders with the opportunity to sell their Public Shares to the Company by means of a tender offer (and thereby avoid the need for a stockholder vote) for an amount in cash equal to their pro rata share of the aggregate amount then on deposit in the Trust Account as of two business days prior to the consummation of the Initial Business Combination, including interest but less taxes payable. The decision as to whether the Company will seek stockholder approval of the Initial Business Combination or will allow stockholders to sell their Public Shares in a tender offer will be made by the Company, solely in its discretion, and will be based on a variety of factors such as the timing of the transaction and whether the terms of the transaction would otherwise require the Company to seek stockholder approval, unless a vote is required by law or under NASDAQ rules. If the Company seeks stockholder approval, it will complete its Initial Business Combination only if a majority of the outstanding shares of Common Stock voted are voted in favor of the Initial Business Combination. However, in no event will the Company redeem its Public Shares in an amount that would cause its net tangible assets to be less than \$5,000,001 either immediately prior to or upon consummation of the Initial Business Combination. In such case, the Company would not proceed with the redemption of its Public Shares and the related Initial Business Combination, and instead may search for an alternate Initial Business Combination.

If the Company seeks stockholder approval of the initial Business Combination and the Company does not conduct redemptions in connection with the Business Combination pursuant to the tender offer rules, the certificate of incorporation provides that a public stockholder, individually or together with any affiliate of such stockholder or any other person with whom such stockholder is acting in concert or as a “group” (as defined under Section 13 of the Exchange Act), will be restricted from seeking redemption rights with respect to more than an aggregate of 20% of the shares sold in the Initial Public Offering. Furthermore, in order for a public stockholder to have his, her or its shares redeemed for cash in connection with any proposed Business Combination, the Company may require that the public stockholders vote either in favor of or against a proposed Business Combination. If required to vote pursuant to the procedures specified in the proxy statement to stockholders relating to the Business Combination, and a public stockholder fails to vote in favor of or against the proposed Business Combination, whether that stockholder abstains from the vote or simply does not vote, that stockholder would not be able to have his, her or its shares of Common Stock redeemed to cash in connection with such Business Combination.

The initial stockholders have agreed to waive their redemption rights with respect to any shares they own in connection with the consummation of the initial Business Combination, including their founder shares and public shares that they have purchased during or after the offering, if any. In addition, the initial stockholders have agreed to waive their rights to liquidating distributions with respect to its founder shares if the Company fails to consummate the initial Business Combination within 12 months (or up to 18 months, as applicable) from the closing of the offering. However, if the initial stockholders acquire public shares in or after the Initial Public Offering, they will be entitled to receive liquidating distributions with respect to such public shares if the Company fails to consummate the initial Business Combination within the required time period.

If the Company does not complete a business combination within 12 months (or up to 18 months, as applicable) from the closing of this offering (the “Combination Period”), the Company will (i) cease all operations except for the purpose of winding up, (ii) as promptly as reasonably possible but not more than ten business days thereafter, redeem 100% of the outstanding public shares and (iii) as promptly as reasonably possible following such redemption, subject to the approval of the remaining stockholders and the board of directors, dissolve and liquidate, subject (in the case of (ii) and (iii) above) to the obligations under Delaware law to provide for claims of creditors and the requirements of other applicable law. There will be no redemption rights or liquidating distributions with respect to the warrants, which will expire worthless if the Company fails to complete the Business Combination within the time period.

CLEANTECH ACQUISITION CORP.
NOTES TO CONDENSED CONSOLIDATED FINANCIAL STATEMENTS
MARCH 31, 2022
(UNAUDITED)

NOTE 1. DESCRIPTION OF ORGANIZATION AND BUSINESS OPERATIONS (cont.)

In order to protect the amounts in the Trust Account, the Sponsor has agreed that it will be liable to the Company if and to the extent any claims by a third party for services rendered or products sold to the Company, or a prospective target business with which the Company has discussed entering into a transaction agreement, reduce the amount of funds in the Trust Account to below (i) \$10.10 per Public Share or (ii) the actual amount per Public Share held in the Trust Account as of the date of the liquidation of the Trust Account, if less than \$10.10 per Public Share due to reductions in the value of the trust assets, less taxes payable, provided that such liability will not apply to any claims by a third party or prospective target business who executed a waiver of any and all rights to the monies held in the Trust Account (whether or not such waiver is enforceable) nor will it apply to any claims under the Company's indemnity of the underwriters of the Initial Public Offering against certain liabilities, including liabilities under the Securities Act of 1933, as amended (the "Securities Act"). The Company will seek to reduce the possibility that the Sponsor will have to indemnify the Trust Account due to claims of creditors by endeavoring to have all vendors, service providers (except the Company's independent registered public accounting firm), prospective target businesses or other entities with which the Company does business, execute agreements with the Company waiving any right, title, interest or claim of any kind in or to monies held in the Trust Account.

Business Combination Agreement

On December 16, 2021, the Company entered into an Agreement and Plan of Merger, as amended on January 30 and June 6, 2022 (the "Merger Agreement," and together with the other agreements and transactions contemplated by the Merger Agreement, the "Business Combination") with CleanTech Merger Sub, Inc., a Delaware corporation and a wholly owned subsidiary of CleanTech ("Merger Sub"), and Nauticus Robotics, Inc., a Texas corporation ("Nauticus"). Pursuant to the terms of the Merger Agreement, a business combination between CleanTech and Nauticus will be effected through the merger of Merger Sub with and into Nauticus, with Nauticus surviving the merger as a wholly owned subsidiary of CleanTech (the "Merger"). The Board of Directors of CleanTech (the "Board") has unanimously (i) approved and declared advisable the Merger Agreement, the Merger and the other transactions contemplated thereby and (ii) resolved to recommend approval of the Merger Agreement and related matters by the stockholders of CleanTech.

Preferred Stock. Immediately prior to the effective time of the Merger (the "Effective Time"), each share of Nauticus Preferred Stock that is issued and outstanding immediately prior to such time shall automatically convert into shares of Nauticus Common Stock, par value \$0.01 per share (the "Nauticus Common Stock"), in accordance with its Certificate of Incorporation (collectively, the "Nauticus Preferred Stock Conversion"). An aggregate of 15,062,524 shares of CLAQ Common Stock will be issued to the holders of Nauticus Preferred Stock.

Convertible Notes. Immediately prior to the Effective Time, each of (i) that certain Unsecured Convertible Promissory Note, dated June 19, 2021, by and between Goradia Capital, LLC and Nauticus, as amended on December 16, 2021, (ii) that certain Unsecured Convertible Promissory Note, August 3, 2021, by and between Material Impact Fund II, L.P. and Nauticus, as amended on December 16, 2021, (iii) that certain Unsecured Convertible Promissory Note, dated October 22, 2021, by and between In-Q-Tel, Inc. and Nauticus, as amended on December 16, 2021, (iv) that certain Unsecured Convertible Promissory Note, dated July 28, 2020, by and between Schlumberger Technology Corporation and Nauticus, as amended on December 16, 2021, and (v) that certain Unsecured Convertible Promissory Note, dated December 7, 2020, by and between Transocean Inc. and Nauticus, as amended on December 16, 2021 (each, a "Nauticus Convertible Note" and collectively, the "Nauticus Convertible Notes") shall automatically convert into shares of Nauticus Common Stock in accordance with the terms of each such Nauticus Convertible Note (collectively, the "Nauticus Convertible Notes Conversion"). An aggregate of 5,299,543 shares of CLAQ Common Stock will be issued to the holders of Nauticus Convertible Notes.

Common Stock. At the Effective Time, following the Nauticus Preferred Stock Conversion and Nauticus Convertible Notes Conversion, each share of Nauticus Common Stock (including shares of Nauticus Common Stock outstanding as a result of the Nauticus Preferred Stock Conversion and Nauticus Convertible Notes Conversion, but excluding shares of the holders of which perfect rights of appraisal under Delaware law) will be converted into the right to receive the applicable Per Share Merger Consideration (as defined below) and the Earnout Shares (as defined below). An aggregate of 9,669,216 shares of CLAQ Common Stock will be issued to the holders of Nauticus Common Stock.

CLEANTECH ACQUISITION CORP.
NOTES TO CONDENSED CONSOLIDATED FINANCIAL STATEMENTS
MARCH 31, 2022
(UNAUDITED)

NOTE 1. DESCRIPTION OF ORGANIZATION AND BUSINESS OPERATIONS (cont.)

Stock Options. At the Effective Time, each outstanding option to purchase shares of Nauticus Common Stock (a “Nauticus Option”), whether or not then vested and exercisable, will be assumed by CLAQ and converted automatically (and without any required action on the part of such holder of outstanding option) into an option to purchase shares of the CLAQ’s Common Stock equal to the number of shares determined by multiplying the number of shares of the Nauticus Common Stock subject to such Nauticus Option immediately prior to the Effective Time by the Exchange Ratio (as defined below), which product shall be rounded down to the nearest whole number of shares, at a per share exercise price determined by dividing the per share exercise price of such Nauticus Option immediately prior to the Effective Time by the Exchange Ratio. Options to purchase an aggregate of 4,055,704 shares of CLAQ Common Stock will be issued to the holders of Nauticus Options.

Earnout Shares. Following the closing of the merger, former holders of shares of Nauticus Common Stock (including shares received as a result of the Nauticus Preferred Stock conversion and the Nauticus Convertible Notes conversion) shall be entitled to receive their pro rata share of up to 7,500,000 additional shares of CleanTech Common Stock (the “Earnout Shares”) if, within a 5-year period following the signing date of the Merger Agreement, the closing share price of the CleanTech Common Stock equals or exceeds any of three thresholds over any 20 trading days within a 30-day trading period (each, a “Triggering Event”).

- (i) one-half of the Escrow Shares will be released if, within a 5-year period following the signing date of the Merger Agreement, the volume-weighted average price of the Combined Company Common Stock equals or exceeds \$15.00 per share over any 20 trading days within a 30-day trading period;
- (ii) one-quarter of the Escrow Shares will be released if, within a 5-year period following the signing date of the Merger Agreement, the volume-weighted average price of the Combined Company Common Stock equals or exceeds \$17.50 per share over any 20 trading days within a 30-day trading period; and
- (iii) one-quarter of the Escrow Shares will be released if, within a 5-year period following the signing date of the Merger Agreement, the volume-weighted average price of the Combined Company Common Stock equals or exceeds \$20.00 per share over any 20 trading days within a 30-day trading period.

On or about December 14, 2021, the Company entered into subscription agreements, with certain investors pursuant to which, among other things, the Company agreed to issue and sell, in a private placement to close immediately prior to the closing of the Business Combination, an aggregate of 3,530,000 shares of our common stock for \$10.00 per share for a total of \$35.3 million (the “Equity Financing”). On December 16, 2021, the Company entered into a Securities Purchase Agreement with certain investors purchasing up to an aggregate of \$40.0 million in principal amount of secured debentures (the “Debentures”) and warrants substantially concurrently with the closing of the Business Combination. The number of shares of common stock into which the Debentures are convertible is equal to 120% of the outstanding principal amount of the Debentures divided by the conversion price of \$15.00, and the number of shares of common stock into which the associated warrants are exercisable is equal to 120% of the outstanding principal amount of the Debentures divided by the conversion price, with an exercise price equal to \$20, subject to adjustment (the “Debt Financing,” and together with the Equity Financing, the “PIPE Investment”). There will be an original issue discount of 2% from the issued amount of the Debentures. Interest will accrue on all outstanding principal amount of the Debentures at 5% per annum, payable quarterly. The Debentures will be secured by first priority interests, and liens on, all present and after-acquired assets of the Combined Company, and will mature on the fourth anniversary of the date of issuance. As of the date of these financial statements, ATW Special Situations I LLC (“ATW”) is the only purchaser and has subscribed for Debentures in the an aggregate principal amount of \$37,959,184 which is convertible into 3,036,735 shares of the Combined Company’s common stock and associated warrants for an additional 3,036,735 shares of the Combined Company’s common stock. ATW is managed by ATW Partners Opportunities Management, LLC, which is an affiliate of Chardan Capital Markets, LLC (“Chardan”), and our director, Mr. Jonas Grossman, is the Managing Partner and President of Chardan. Chardan will not receive any fees or compensation for ATW’s participation in the Debt Financing.

It is anticipated that upon completion of the Business Combination, CLAQ’s public stockholders (other than the PIPE Investment investors) would retain an ownership interest of approximately 28.5% in the Combined Company, the PIPE Investment investors will own approximately 5.6% of the Combined Company (such that the

CLEANTECH ACQUISITION CORP.
NOTES TO CONDENSED CONSOLIDATED FINANCIAL STATEMENTS
MARCH 31, 2022
(UNAUDITED)

NOTE 1. DESCRIPTION OF ORGANIZATION AND BUSINESS OPERATIONS (cont.)

public stockholders, including the PIPE Investment investors, would own approximately 34.1% of the Combined Company), the Co-Sponsors, officers, directors and other holders of founder shares will retain an ownership interest of approximately 6.8% of the Combined Company and the Nauticus stockholders will own approximately 59.1% (including the 7,500,000 Earnout Shares) of the Combined Company. The ownership percentage with respect to the Combined Company does not take into account (i) the redemption of any shares by the CLAQ's public stockholders or (ii) the issuance of any additional shares upon the closing of the Business Combination under the 2015 Equity Incentive Plan. If the actual facts are different from these assumptions (which they are likely to be), the percentage ownership retained by the CLAQ stockholders will be different.

The Merger Agreement contains customary representations and warranties of the parties thereto with respect to, among other things, (a) entity organization, good standing and qualification, (b) capital structure, (c) authorization to enter into the Merger Agreement, (d) compliance with laws and permits, (e) taxes, (f) financial statements and internal controls, (g) real and personal property, (h) material contracts, (i) environmental matters, (j) absence of changes, (k) employee matters, (l) litigation, and (m) brokers and finders.

The Merger Agreement includes customary covenants of the parties with respect to operation of their respective businesses prior to consummation of the Merger and efforts to satisfy conditions to consummation of the Merger. The Merger Agreement also contains additional covenants of the parties, including, among others, covenants providing for CleanTech and Nauticus to use reasonable best efforts to cooperate in the preparation of the Registration Statement and Proxy Statement (as each such term is defined in the Merger Agreement) required to be filed in connection with the Merger and to obtain all requisite approvals of their respective stockholders including, in the case of CleanTech, approvals of the restated certificate of incorporation, the share issuance under Nasdaq rules and the omnibus incentive plan. CleanTech has also agreed to include in the Proxy Statement the recommendation of its board that stockholders approve all of the proposals to be presented at the special meeting.

CleanTech has agreed to approve and adopt a 2022 omnibus incentive plan (the "Incentive Plan") to be effective as of the closing and in a form mutually acceptable to CleanTech and Nauticus. The Incentive Plan shall provide for an initial aggregate share reserve equal to 10% of the number of shares of CleanTech Common Stock on a fully diluted basis at the closing. Subject to approval of the Incentive Plan by CleanTech's stockholders, CleanTech has agreed to file a Form S-8 Registration Statement with the SEC following the Effective Time with respect to the shares of CleanTech Common Stock issuable under the Incentive Plan.

Each of CleanTech and Nauticus has agreed that from the date of the Merger Agreement to the Effective Time or, if earlier, the valid termination of the Merger Agreement in accordance with its terms, it will not initiate any negotiations with any party, or provide non-public information or data concerning it or its subsidiaries to any party relating to an Acquisition Proposal or Alternative Transaction (as such terms are defined in the Merger Agreement) or enter into any agreement relating to such a proposal. Each of CleanTech and Nauticus has also agreed to use its reasonable best efforts to prevent any of its representatives from doing the same.

The consummation of the Merger is conditioned upon, among other things, (i) receipt of the CleanTech stockholder approval and Nauticus stockholder approval, (ii) the expiration or termination of the waiting period under the Hart-Scott-Rodino Antitrust Improvements Act of 1976, as amended, (iii) the absence of any governmental order, statute, rule or regulation enjoining or prohibiting the consummation of the Transactions, (iv) the effectiveness of the Registration Statement under the Securities Act, (v) CleanTech having at least \$5,000,001 of net tangible assets (as determined in accordance with Rule 3a51-1(g)(1) of the Securities Exchange Act of 1934, as amended (the "Exchange Act")), (vi) solely with respect to CleanTech, (A) the representations and warranties of Nauticus being true and correct to applicable standards applicable and each of the covenants of Nauticus having been performed or complied with in all material respects and (B) the approval of the conversion of the convertible notes and (vii) solely with respect to Nauticus, (A) the representations and warranties of CleanTech being true and correct to applicable standards applicable and each of the covenants of CleanTech having been performed or complied with in all material respects (B) the receipt of the approval for listing by Nasdaq of the shares of CleanTech Common Stock to be issued

CLEANTECH ACQUISITION CORP.
NOTES TO CONDENSED CONSOLIDATED FINANCIAL STATEMENTS
MARCH 31, 2022
(UNAUDITED)

NOTE 1. DESCRIPTION OF ORGANIZATION AND BUSINESS OPERATIONS (cont.)

in connection with the transactions contemplated by the Merger Agreement, (C) the effective resignations of certain directors and executive officers of CleanTech, (D) the amount of Minimum Cash Condition (as defined in the Merger Agreement) being equal to or exceeding \$50,000,000.

Other Agreements

The Business Combination Agreement contemplates the execution of various additional agreements and instruments, on or before the Closing, including, among others, the following:

Support Agreements

In connection with the execution of the Merger Agreement, CleanTech Sponsor I LLC and CleanTech Investments, LLC (each, a “Sponsor,” and collectively, the “Co-Sponsors”) entered into a support agreement (the “Sponsor Support Agreement”) with Nauticus pursuant to which the Sponsors have agreed to vote all shares of CleanTech Common Stock beneficially owned by them in favor of the Merger.

In addition, in connection with the execution of the Merger Agreement, certain stockholders of Nauticus owning approximately 88.8% of the voting power of Nauticus entered into a support agreement (the “Nauticus Support Agreement”) with CleanTech and Nauticus pursuant to which the stockholders agreed to vote all shares of Nauticus beneficially owned by them in favor of the Merger.

Subscription Agreements

In connection with the execution of the Merger Agreement, CleanTech entered into subscription agreements (collectively, the “Subscription Agreements”) with certain parties subscribing for shares of CleanTech Common Stock (the “Subscribers”) pursuant to which the Subscribers have agreed to purchase, and CleanTech has agreed to sell to the Subscribers, an aggregate of 3,530,000 shares of CleanTech Common Stock, for a purchase price of \$10.00 per share and an aggregate purchase price of \$35.3 million. The obligations to consummate the transactions contemplated by the Subscription Agreements are conditioned upon, among other things, customary closing conditions and the consummation of the transactions contemplated by the Merger Agreement.

Securities Purchase Agreement

In connection with the execution of the Merger Agreement, CleanTech and Nauticus entered into Securities Purchase Agreement with certain investors purchasing up to an aggregate of \$40,000,000 in principal amount of Debentures and Warrants. The number of shares of Common Stock into which the Debentures are convertible is equal to 120% of the aggregate issued amount of the Debentures divided by the conversion price of \$15.00, and the number of shares of Common Stock into which the associated Warrants are exercisable is equal to 120% of the outstanding principal amount of the Debentures divided by the conversion price, with an exercise price equal to \$20.00, subject to adjustment (“Debt Financing”). The obligations to consummate the transactions contemplated by the Securities Purchase Agreement are conditioned upon, among other things, customary closing conditions and all conditions precedent to the Merger set forth in the Merger Agreement shall have been satisfied or waived.

Amended and Restated Registration Rights Agreement

In connection with the Closing, Nauticus, CleanTech and certain stockholders of each of Nauticus and CleanTech who will receive shares of CleanTech Common Stock pursuant to the Merger Agreement, will enter into an amended and restated registration rights agreement (“Registration Rights Agreement”) mutually agreeable to CleanTech and Nauticus, which will become effective upon the consummation of the Merger.

CLEANTECH ACQUISITION CORP.
NOTES TO CONDENSED CONSOLIDATED FINANCIAL STATEMENTS
MARCH 31, 2022
(UNAUDITED)

NOTE 1. DESCRIPTION OF ORGANIZATION AND BUSINESS OPERATIONS (cont.)

Lock-up Agreement and Arrangements

In connection with the Closing, the Sponsors and certain Nauticus stockholders will enter into a lock-up agreement (the “Sponsor Lock-Up Agreement” and “Company Stockholder Lock-up Agreement”) with Nauticus and CleanTech, pursuant to which each will agree, subject to certain customary exceptions, not to:

- (i) offer, sell, contract to sell, pledge or otherwise dispose of, directly or indirectly, any shares of CleanTech Common Stock received as merger consideration and held by it immediately after the Effective Time (the “Lock-Up Shares”), or enter into a transaction that would have the same effect;
- (ii) enter into transaction that would have the same effect, or enter into any swap, hedge or other arrangement that transfers, in whole or in part, any of the economic consequences of ownership of any of such shares, whether any of these transactions are to be settled by delivery of such shares, in cash or otherwise; or
- (iii) publicly disclose the intention to make any offer, sale, pledge or disposition, or to enter into any transaction, swap, hedge or other arrangement, or engage in any “Short Sales” (as defined in the Sponsor Lock-Up Agreement and Company Stockholder Lock-up Agreement) with respect to any security of CleanTech; during a “Lock-Up Period” under their respective agreements.

Under the Sponsor Lock-up Agreement, the Lock-Up period means the period commencing on the Closing Date and ending on the earlier of (x) the one year anniversary of the Closing Date; (y) the date on which the volume weighted average price of shares of Common Stock equals or exceeds \$13.00 per share for twenty (20) of any thirty (30) consecutive trading days commencing after the Closing on Nasdaq, and (z) the date specified in a written waiver duly executed by Nauticus; provided that the restrictions set forth in the Sponsor Lock-up Agreement do not apply to (1) transfers or distributions to such stockholder’s current or former general or limited partners, managers or members, stockholders, other equity holders or direct or indirect affiliates (within the meaning of Rule 405 under the Securities Act of 1933, as amended) or to the estates of any of the foregoing; (2) transfers by bona fide gift to a member of the stockholder’s immediate family or to a trust, the beneficiary of which is the stockholder or a member of the stockholder’s immediate family for estate planning purposes; (3) by virtue of the laws of descent and distribution upon death of the stockholder; or (4) pursuant to a qualified domestic relations order, in each case where such transferee agrees to be bound by the terms of the Sponsor Lock-up Agreement.

Under the Company Lock-up Agreement, the Lock-Up period means the period commencing on the Closing Date and ending on the earlier of (x) the date that is 180 calendar days after the consummation of the Business Combination, (y) the date on which the volume weighted average price of shares of Common Stock equals or exceeds \$13.00 per share for twenty (20) of any thirty (30) consecutive trading days commencing after the Closing on Nasdaq, and (z) the date specified in a written waiver duly executed by the Sponsors and CleanTech; provided that the restrictions set forth in the Company Lock-up Agreement do not apply to (1) transfers or distributions to such stockholders current or former general or limited partners, managers or members, stockholders, other equityholders or other direct or indirect affiliates (within the meaning of Rule 405 under the Securities Act of 1933, as amended) or to the estates of any of the foregoing; (2) transfers by bona fide gift to a member of the stockholder’s immediate family or to a trust, the beneficiary of which is the stockholder or a member of the stockholder’s immediate family for estate planning purposes; (3) by virtue of the laws of descent and distribution upon death of the stockholder; (4) pursuant to a qualified domestic relations order, in each case where such transferee agrees to be bound by the terms of this Agreement; (5) transfers or distributions of, or other transactions involving, securities other than the Lock-up Shares (including, without limitation, securities acquired in the PIPE or in open market transactions); or (6) in the case of Angela Berka (or Reginald Berka with respect to any community, marital or similar interest he may have in the following shares), the transfer of up to 1,000,000 shares of Lock-up Shares in a privately negotiated sale to another company stockholder, who shall enter into a Lock-Up Agreement (or amend an existing Lock-Up Agreement) containing the same terms and conditions as this Agreement with respect to such shares, or the entry into any agreement with respect to such a sale entered into before, at or after the Effective Time.

CLEANTECH ACQUISITION CORP.
NOTES TO CONDENSED CONSOLIDATED FINANCIAL STATEMENTS
MARCH 31, 2022
(UNAUDITED)

NOTE 1. DESCRIPTION OF ORGANIZATION AND BUSINESS OPERATIONS (cont.)

Director Nomination Agreement

In connection with the Closing, CleanTech, the Sponsors and Nauticus will enter into a Director Nomination Agreement (the “Director Nomination Agreement”) pursuant to which CleanTech will agree to nominate an individual designated by the Sponsors to the Board of Directors of the Combined Company, effective as of immediately prior to the Closing.

Director Designation Agreement

In connection with the execution of the Merger Agreement, CleanTech, Nauticus and certain Nauticus stockholders entered into a director designation agreement with Transocean, Inc. (“Transocean”) to take all necessary action to cause a member designated by Transocean (the “Transocean Designee”) to remain on, or otherwise be appointed to, the Board, from and after the effective time of the Merger, as a Class III member of the Board, for an initial term expiring at the third annual meeting following the date of the Second Amended and Restated Certificate of Incorporation to be adopted in connection with the Merger.

Indemnification Agreements

In connection with the Closing, CleanTech has agreed to enter into customary indemnification agreements, in form and substance reasonably acceptable to CleanTech and Nauticus, with the individuals who will be nominated and, subject to stockholder approval, elected to CleanTech’s board of directors effective as of the Closing.

Going Concern Consideration

As of March 31, 2022, the Company had \$296,381 in cash held outside of the Trust Account and working capital deficit of \$220,239. As a result of the above, in connection with the Company’s assessment of going concern considerations in accordance with Financial Accounting Standard Board’s (“FASB”) Accounting Standards Update (“ASU”) 2014-15, “Disclosures of Uncertainties about an Entity’s Ability to Continue as a Going Concern,” management has determined that the liquidity condition and date for mandatory liquidation and dissolution raise substantial doubt about the Company’s ability to continue as a going concern through July 19, 2022, the scheduled liquidation date of the Company if it does not complete a Business Combination prior to such date. These condensed consolidated financial statements do not include any adjustments relating to the recovery of the recorded assets or the classification of the liabilities that might be necessary should the Company be unable to continue as a going concern.

Principles of Consolidation

The accompanying condensed consolidated financial statements include the accounts of the Company and its wholly-owned subsidiary. All significant intercompany balances and transactions have been eliminated in consolidation.

Risks and Uncertainties

Management continues to evaluate the impact of the COVID-19 pandemic on the industry and has concluded that while it is reasonably possible that the virus could have a negative effect on the Company’s financial position, results of its operations, and/or search for a target company, the specific impact is not readily determinable as of the date of these condensed consolidated financial statements. The condensed consolidated financial statements do not include any adjustments that might result from the outcome of this uncertainty.

In February 2022, the Russian Federation and Belarus commenced a military action with the country of Ukraine. As a result of this action, various nations, including the United States, have instituted economic sanctions against the Russian Federation and Belarus. Further, the impact of this action and related sanctions on the world economy is not determinable as of the date of these financial statements. The specific impact on the Company’s financial condition, results of operations, and cash flows is also not determinable as of the date of these unaudited condensed financial statements.

CLEANTECH ACQUISITION CORP.
NOTES TO CONDENSED CONSOLIDATED FINANCIAL STATEMENTS
MARCH 31, 2022
(UNAUDITED)

NOTE 2. BASIS OF PRESENTATION AND SUMMARY OF SIGNIFICANT ACCOUNTING POLICIES

Basis of Presentation

The accompanying unaudited condensed consolidated financial statements of the Company are presented in conformity with accounting principles generally accepted in the United States of America (“GAAP”) and pursuant to the rules and regulations of the SEC. Certain information or footnote disclosures normally included in financial statements prepared in accordance with GAAP have been condensed or omitted, pursuant to the rules and regulations of the SEC for interim financial reporting. Accordingly, they do not include all the information and footnotes necessary for a comprehensive presentation of financial position, results of operations, or cash flows. In the opinion of management, the accompanying condensed consolidated financial statements include all adjustments, consisting of a normal recurring nature, which are necessary for a fair presentation of the financial position, operating results and cash flows for the periods presented. The accompanying condensed consolidated financial statements should be read in conjunction with the Company’s Form 10-K as filed with the SEC on March 29, 2022. The interim results for the three months ended March 31, 2022 are not necessarily indicative of the results to be expected for the year ending December 31, 2022 or for any future periods.

Emerging Growth Company

The Company is an “emerging growth company,” as defined in Section 2(a) of the Securities Act, as modified by the Jumpstart Our Business Startups Act of 2012 (the “JOBS Act”), and it may take advantage of certain exemptions from various reporting requirements that are applicable to other public companies that are not emerging growth companies including, but not limited to, not being required to comply with the auditor attestation requirements of Section 404 of the Sarbanes-Oxley Act, reduced disclosure obligations regarding executive compensation in its periodic reports and proxy statements, and exemptions from the requirements of holding a nonbinding advisory vote on executive compensation and stockholder approval of any golden parachute payments not previously approved.

Further, Section 102(b)(1) of the JOBS Act exempts emerging growth companies from being required to comply with new or revised financial accounting standards until private companies (that is, those that have not had a Securities Act registration statement declared effective or do not have a class of securities registered under the Exchange Act) are required to comply with the new or revised financial accounting standards. The JOBS Act provides that a company can elect to opt out of the extended transition period and comply with the requirements that apply to non-emerging growth companies but any such election to opt out is irrevocable. The Company has elected not to opt out of such extended transition period which means that when a standard is issued or revised and it has different application dates for public or private companies, the Company, as an emerging growth company, can adopt the new or revised standard at the time private companies adopt the new or revised standard. This may make comparison of the Company’s financial statement with another public company which is neither an emerging growth company nor an emerging growth company which has opted out of using the extended transition period difficult or impossible because of the potential differences in accounting standards used.

Use of Estimates

The preparation of condensed consolidated financial statements in conformity with GAAP requires the Company’s management to make estimates and assumptions that affect the reported amounts of assets and liabilities and disclosure of contingent assets and liabilities at the date of the condensed consolidated financial statements and the reported amounts of expenses during the reporting periods.

Making estimates requires management to exercise significant judgment. It is at least reasonably possible that the estimate of the effect of a condition, situation or set of circumstances that existed at the date of the condensed consolidated financial statements, which management considered in formulating its estimate, could change in the near term due to one or more future confirming events. One of the more significant accounting estimates included in these condensed consolidated financial statements is the determination of the fair value of the warrant liabilities. Accordingly, the actual results could differ from those estimates.

CLEANTECH ACQUISITION CORP.
NOTES TO CONDENSED CONSOLIDATED FINANCIAL STATEMENTS
MARCH 31, 2022
(UNAUDITED)

NOTE 2. BASIS OF PRESENTATION AND SUMMARY OF SIGNIFICANT ACCOUNTING POLICIES (cont.)

Cash and Cash Equivalents

The Company considers all short-term investments with an original maturity of three months or less when purchased to be cash equivalents. The Company did not have any cash equivalents as of March 31, 2022 or December 31, 2021.

Investments Held in Trust Account

At March 31, 2022 and December 31, 2021, the assets held in the Trust Account were held in money market funds, which are invested in U.S. Treasury securities. Trading securities are presented on the balance sheet at fair value at the end of each reporting period. Gains and losses resulting from the change in fair value of these securities is included in unrealized gains (losses) on investments held in Trust Account in the accompanying unaudited condensed consolidated statements of operations. Interest and dividend income on these securities is included in net gain on investments held in Trust Account in the accompanying unaudited condensed consolidated statements of operations.

Common Stock Subject to Possible Redemption

The Company accounts for its Common Stock subject to possible redemption in accordance with the guidance in ASC Topic 480, Distinguishing Liabilities from Equity. Common Stock subject to mandatory redemption (if any) is classified as liability instruments and are measured at fair value. Conditionally redeemable Common Stock (including Common Stock that feature redemption rights that are either within the control of the holder or subject to redemption upon occurrence of uncertain events not solely within the Company's control) are classified as temporary equity. At all other times, Common Stock are classified as stockholders' equity. The Company's Common Stock feature certain redemption rights that are considered to be outside of the Company's control and subject to the occurrence of uncertain future events. Accordingly, as of March 31, 2022 and December 31, 2021, 17,250,000 Common Stock subject to possible redemption are presented as temporary equity, outside of the stockholders' deficit section of the Company's balance sheet. Effective with the closing of the Initial Public Offering, the Company recognized the accretion from the initial book value to redemption amount, which resulted in charges against additional paid-in capital (to the extent available) and accumulated deficit.

The Company recognizes changes in redemption value immediately as they occur and adjusts the carrying value of redeemable Common Stock to equal the redemption value at the end of each reporting period. This method would view the end of the reporting period as if it were also the redemption date for the security. Increases or decreases in the carrying amount of redeemable Common Stock are affected by charges against additional paid in capital and accumulated deficit.

As of March 31, 2022 and December 31, 2021, the common stock reflected in the consolidated condensed balance sheet is reconciled in the following table:

Gross proceeds	\$ 172,500,000
Less:	
Proceeds allocated to Public Warrants	(6,037,500)
Proceeds allocated to Public Rights	(3,934,879)
Issuance costs allocated to common stock	(3,672,335)
Plus:	
Accretion of carrying value to redemption value	15,369,714
Common stock subject to possible redemption	\$ 174,225,000

CLEANTECH ACQUISITION CORP.
NOTES TO CONDENSED CONSOLIDATED FINANCIAL STATEMENTS
MARCH 31, 2022
(UNAUDITED)

NOTE 2. BASIS OF PRESENTATION AND SUMMARY OF SIGNIFICANT ACCOUNTING POLICIES (cont.)

Offering Costs Associated with the Initial Public Offering

The Company complies with the requirements of ASC 340-10-S99-1 and SEC Staff Accounting Bulletin Topic 5A — Expenses of Offering. Offering costs consist principally of professional and registration fees incurred through the balance sheet date that are related to the Initial Public Offering. Offering costs directly attributable to the issuance of an equity contract to be classified in equity are recorded as a reduction in equity. Offering costs for equity contracts that are classified as assets and liabilities are expensed immediately. The Company incurred offering costs amounting to \$3,916,281 as a result of the Initial Public Offering (consisting of a \$3,450,000 underwriting discount and \$466,281 of other offering costs). The Company recorded \$3,672,335 of offering costs as a reduction of equity in connection with the redeemable Common Stock included in the Units. The Company recorded \$88,910 of offering costs as a reduction of permanent equity in connection with the Rights classified as equity instruments. The Company immediately expensed \$155,037 of offering costs in connection with the Public Warrants and Private Placement Warrants that were classified as liabilities.

Derivative Warrant Liabilities

The Company accounts for warrants as either equity-classified or liability-classified instruments based on an assessment of the warrant's specific terms and applicable authoritative guidance in ASC 480, Distinguishing Liabilities from Equity ("ASC 480"), and ASC 815, Derivatives and Hedging ("ASC 815"). The assessment considers whether the warrants are freestanding financial instruments pursuant to ASC 480, meet the definition of a liability pursuant to ASC 480, and whether the warrants meet all of the requirements for equity classification under ASC 815, including whether the warrants are indexed to the Company's own Common Stock, among other conditions for equity classification. This assessment, which requires the use of professional judgment, is conducted at the time of warrant issuance and as of each subsequent quarterly period end date while the warrants are outstanding.

The Company evaluates its financial instruments to determine if such instruments are derivatives or contain features that qualify as embedded derivatives in accordance with ASC Topic 815, Derivatives and Hedging. For derivative financial instruments that are accounted for as liabilities, the derivative instrument is initially recorded at its fair value on the grant date and is then re-valued at each reporting date, with changes in the fair value reported in the consolidated statements of operations. The classification of derivative instruments, including whether such instruments should be recorded as liabilities or as equity, is evaluated at the end of each reporting period. Derivative liabilities are classified in the balance sheet as current or non-current based on whether or not net-cash settlement or conversion of the instrument could be required within 12 months of the balance sheet date.

For issued or modified warrants that meet all of the criteria for equity classification, the warrants are required to be recorded as a component of additional paid-in capital at the time of issuance. For issued or modified warrants that do not meet all the criteria for equity classification, the warrants are required to be recorded at their initial fair value on the date of issuance, and each balance sheet date thereafter. For the initial valuation, the Company utilized a Monte Carlo simulation model for the initial valuation of the Public Warrants, and the publicly-traded value for the subsequent valuation of the Public Warrants. Changes in the estimated fair value of the warrants are recognized as a non-cash gain or loss on the consolidated statements of operations. The fair value of the Private Placement Warrants was estimated using a Black-Scholes Option Pricing Model (see Note 9). The subsequent measurement of the Public Warrants as of March 31, 2021 and December 31, 2021 is classified as Level 1, as such, an observable market quote in an active market under the ticker CLAQW was used.

Income Taxes

The Company complies with the accounting and reporting requirements of ASC Topic 740, Income Taxes, which requires an asset and liability approach to financial accounting and reporting for income taxes. Deferred income tax assets and liabilities are computed for differences between the financial statement and tax bases of assets and liabilities

CLEANTECH ACQUISITION CORP.
NOTES TO CONDENSED CONSOLIDATED FINANCIAL STATEMENTS
MARCH 31, 2022
(UNAUDITED)

NOTE 2. BASIS OF PRESENTATION AND SUMMARY OF SIGNIFICANT ACCOUNTING POLICIES (cont.)

that will result in future taxable or deductible amounts, based on enacted tax laws and rates applicable to the periods in which the differences are expected to affect taxable income. Valuation allowances are established, when necessary, to reduce deferred tax assets to the amount expected to be realized.

ASC 740 prescribes a recognition threshold and a measurement attribute for the financial statement recognition and measurement of tax positions taken or expected to be taken in a tax return. For those benefits to be recognized, a tax position must be more likely than not to be sustained upon examination by taxing authorities. The Company recognizes accrued interest and penalties related to unrecognized tax benefits as income tax expense. There were no unrecognized tax benefits and no amounts accrued for interest and penalties as of March 31, 2022 and December 31, 2021. The Company is currently not aware of any issues under review that could result in significant payments, accruals or material deviation from its position. The Company is subject to income tax examinations by major taxing authorities since inception. The Company has no expectation of a change in the above for a period of time within one year after the date that the condensed consolidated financial statements are issued.

Net Income Per Share of Common Stock

Net income per share of common stock is computed by dividing net earnings by the weighted average number of shares of common stock outstanding during the period (for all periods during which these shares were subject to forfeiture, the calculation of weighted average shares outstanding excludes an aggregate of 562,500 shares of common stock held by the Sponsor that were subject to forfeiture). The Company has not considered the effect of the Warrants sold in the Initial Public Offering and private placement to purchase an aggregate of 15,800,000 shares in the calculation of diluted income per share, since the exercise of the Warrants are contingent upon the occurrence of future events and the inclusion of such Warrants would be anti-dilutive.

The following table reflects the calculation of basic and diluted net income per share of common stock (in dollars, except per share amounts):

	For the Three Months Ended March 31,	
	2022	2021
Basic and diluted net income per share:		
Numerator:		
Net income	\$ 1,951,670	\$ —
Denominator		
Basic weighted average shares outstanding	21,562,500	4,312,500
Basic net income per share of common stock	\$ 0.09	\$ 0.00

Concentration of Credit Risk

Financial instruments that potentially subject the Company to concentrations of credit risk consist of cash accounts in a financial institution, which, at times may exceed the Federal Depository Insurance Corporation coverage limit of \$250,000. The Company has not experienced losses on these accounts and management believes the Company is not exposed to significant risks on such account.

Fair Value of Financial Instruments

The Company applies ASC Topic 820, Fair Value Measurement (“ASC 820”), which establishes a framework for measuring fair value and clarifies the definition of fair value within that framework. ASC 820 defines fair value as an exit price, which is the price that would be received for an asset or paid to transfer a liability in the Company’s principal or most advantageous market in an orderly transaction between market participants on the measurement date. The fair value hierarchy established in ASC 820 generally requires an entity to maximize the use of observable inputs

CLEANTECH ACQUISITION CORP.
NOTES TO CONDENSED CONSOLIDATED FINANCIAL STATEMENTS
MARCH 31, 2022
(UNAUDITED)

NOTE 2. BASIS OF PRESENTATION AND SUMMARY OF SIGNIFICANT ACCOUNTING POLICIES (cont.)

and minimize the use of unobservable inputs when measuring fair value. Observable inputs reflect the assumptions that market participants would use in pricing the asset or liability and are developed based on market data obtained from sources independent of the reporting entity. Unobservable inputs reflect the entity's own assumptions based on market data and the entity's judgments about the assumptions that market participants would use in pricing the asset or liability and are to be developed based on the best information available in the circumstances.

The carrying amounts reflected in the balance sheet for cash, prepaid expenses and accrued offering costs approximate fair value due to their short-term nature.

- Level 1 — Assets and liabilities with unadjusted, quoted prices listed on active market exchanges. Inputs to the fair value measurement are observable inputs, such as quoted prices in active markets for identical assets or liabilities.
- Level 2 — Inputs to the fair value measurement are determined using prices for recently traded assets and liabilities with similar underlying terms, as well as direct or indirect observable inputs, such as interest rates and yield curves that are observable at commonly quoted intervals.
- Level 3 — Inputs to the fair value measurement are unobservable inputs, such as estimates, assumptions, and valuation techniques when little or no market data exists for the assets or liabilities.

Recent Accounting Standards

Management does not believe that any recently issued, but not yet effective, accounting standards, if currently adopted, would have a material effect on the Company's condensed consolidated financial statements.

NOTE 3. INITIAL PUBLIC OFFERING

Pursuant to the Initial Public Offering which was consummated on July 19, 2021, the Company sold 15,000,000 Units at a purchase price of \$10.00 per Unit. Each Unit consists of one share of the Company's common stock, \$0.0001 par value, one right entitling the holder thereof to receive one-twentieth (1/20) of one share common stock upon the consummation of an initial business combination, and one-half of one redeemable warrant ("Redeemable Warrant"). Each whole Redeemable Warrant is exercisable to purchase one share of common stock and only whole warrants are exercisable. No fractional warrants will be issued upon separation of the Units and only whole warrants will trade. The Redeemable Warrants will become exercisable on the later of 30 days after the completion of the Initial Business Combination or 12 months from the closing of the Initial Public Offering. Each whole Redeemable Warrant entitles the holder to purchase one share of common stock at an exercise price of \$11.50 (see Note 7).

On July 26, 2021, the underwriters fully exercised the over-allotment option and purchased an additional 2,250,000 Units (the "Over-Allotment Units"), generating gross proceeds of \$22,500,000 on July 28, 2021.

NOTE 4. PRIVATE PLACEMENT

Simultaneously with the closing of the Initial Public Offering, the Sponsor and Co-Sponsor purchased an aggregate of 6,500,000 Private Warrants at a price of \$1.00 per Private Placement Warrant (\$6,500,000 in the aggregate). Each Private Placement Warrant is exercisable to purchase one share of common stock at a price of \$11.50 per share. Simultaneously with the sale of Over-Allotment Units, the Company consummated a private sale of an additional 675,000 Private Warrants at a purchase price of \$1.00 per Private Warrant, generating gross proceeds of \$675,000. The proceeds from the sale of the Private Warrants were added to the net proceeds from the Initial Public Offering held in the Trust Account. If the Company does not complete a Business Combination within the Combination Period, the proceeds from the sale of the Private Warrants will be used to fund the redemption of the Public Shares (subject to the requirements of applicable law) and the Private Placement Warrants will expire worthless.

CLEANTECH ACQUISITION CORP.
NOTES TO CONDENSED CONSOLIDATED FINANCIAL STATEMENTS
MARCH 31, 2022
(UNAUDITED)

NOTE 5. RELATED PARTY TRANSACTIONS

Founder Shares

In July 2020, the Sponsor was issued 5,000,000 shares of Common Stock (the “Founder Shares”) for an aggregate price of \$25,000. In February 2021, the Company effected a 1.4375-for-1 stock split of its issued and outstanding shares of Common Stock, resulting in an aggregate of 4,312,500 Founder Shares issued and outstanding. The Founder Shares included an aggregate of up to 562,500 shares of Common Stock subject to forfeiture by the Sponsor to the extent that the underwriters’ over-allotment option is not exercised in full or in part, so that the Sponsor will own, on an as-converted basis, 20% of the Company’s issued and outstanding shares after the Initial Public Offering.

On February 16, 2021, CleanTech Sponsor paid \$16,667 to the Company, which amount was paid to CleanTech Investments LLC to cancel 4,791,667 of its Founder Shares that it previously held and immediately thereafter the Company issued 4,791,667 Founders Shares to CleanTech Sponsor. As a result, CleanTech Sponsor owns 4,791,667 Founders Shares and CleanTech Investments LLC owns 2,395,833 Founder Shares. CleanTech Sponsor and CleanTech Investments LLC will both participate in the purchase of the Private Warrants based their pro rata ownership of Founder Shares.

In June 2021, CleanTech Sponsor and CleanTech Investments forfeited for no consideration 1,916,667 founder shares and 958,333 founder shares, respectively, which the Company cancelled, resulting in a decrease in the total number of founder shares outstanding from 7,187,500 shares to 4,312,500 shares. As a result, CleanTech Sponsor owns 2,875,000 founder shares and CleanTech Investments owns 1,437,500 founder shares. The founder shares include an aggregate of up to 562,500 shares that are subject to forfeiture to the extent that the underwriters’ over-allotment option is not exercised in full or in part. All share and per-share amounts have been retroactively restated to reflect the share forfeiture.

The underwriter exercised the over-allotment option on in full July 28, 2021; thus, no Founders Shares are subject to forfeiture.

Administrative Services Agreement

The Company entered into an agreement, commencing on the July 14, 2021, to pay Chardan Capital Markets, LLC up to \$10,000 per month for office space, administrative and support services. The total amounts of administrative service fees accrued for the three months ended March 31, 2022 and 2021 were \$30,000 and \$0, respectively. Upon completion of the Business Combination or the Company’s liquidation, the Company will cease paying these monthly fees.

Promissory Note — Related Party

On March 1, 2021, the Company issued an unsecured promissory note to the Sponsor (the “Promissory Note”), pursuant to which the Company could borrow an aggregate of up to \$250,000 to cover expenses related to the Initial Public Offering. The Promissory Note was non-interest bearing and is payable on the earlier of Promptly after the date on which the Company consummates an Initial Public Offering of its securities or (ii) the completion of the Initial Public Offering. The outstanding balance under the Promissory Note of \$188,302 was repaid on July 23, 2021. The promissory note is no longer available to the Company.

On March 23, 2022, the Company entered into a Promissory Note with the Sponsor (the “Second Promissory Note”) to which the Company could borrow up to an aggregate of \$267,000. The Second Promissory Note is non-interest bearing and payable upon the earlier of (i) completion of the initial Business Combination or (ii) the date on which the Company determines that it is unable to effect a Business Combination. As March 31, 2022, the outstanding balance under the Second Promissory Note was \$267,000.

CLEANTECH ACQUISITION CORP.
NOTES TO CONDENSED CONSOLIDATED FINANCIAL STATEMENTS
MARCH 31, 2022
(UNAUDITED)

NOTE 5. RELATED PARTY TRANSACTIONS (cont.)

Related Party Loans

In addition, in order to finance transaction costs in connection with an intended initial Business Combination, the Company's Sponsor, Co-Sponsor, or an affiliate of the Sponsor or the officers and directors may, but are not obligated to, loan the Company funds as may be required. If the Company consummates the initial Business Combination, it would repay such loaned amounts. The notes would either be paid upon consummation of the Company's initial Business Combination, without interest, or, at the lender's discretion, up to \$500,000 of the notes may be converted upon consummation of the Business Combination into additional private warrants to purchase shares of common stock at a conversion price of \$1.00 per private warrant (which, for example, would result in the holders being issued private warrants to purchase 500,000 shares of common stock if \$500,000 of notes were so converted). Such private warrants will be identical to the private warrants issued at the closing of the Initial Public Offering. Loans made by Chardan Capital Markets, LLC or any of its related persons will not be convertible into private warrants, and Chardan Capital Markets, LLC and its related persons will have no recourse with respect to their ability to convert their loans into private warrants. As of March 31, 2022 and December 31, 2021, there were no borrowings under these loans.

Related Party Extension Loans

The Company may extend the period of time to consummate a Business Combination up to two times, each by an additional three months (for a total of 18 months to complete a Business Combination). In order to extend the time available for the Company to consummate a Business Combination, without the need for a separate stockholder vote, is for the Company's initial stockholders or their affiliates or designees, upon five days' advance notice prior to the application deadline, to deposit into the trust account \$1,500,000 or \$1,725,000 if the underwriters' over-allotment option is exercised in full (\$0.10 per public share, or an aggregate of \$3,000,000 (or \$3,450,000 if the over-allotment option is exercised in full) if extended for each of the full three months), on or prior to the date of the application deadline. In the event that the stockholders, or affiliates or designees, elect to extend the time to complete the Company's initial business combination and deposit the applicable amount of money into trust, the initial stockholders will receive a non-interest bearing, unsecured promissory note equal to the amount of any such deposit that will not be repaid in the event that the Company is unable to close a business combination unless there are funds available outside the trust account to do so. Such note would be paid upon consummation of the Company's initial Business Combination.

NOTE 6. COMMITMENTS AND CONTINGENCIES

Registration and Stockholder Rights Agreement

Pursuit to a registration rights agreement entered into on July 14, 2021, the holders of insider shares issued and outstanding, as well as the holders of the private warrants (and all underlying securities), will be entitled to registration and stockholder rights pursuant to an agreement to be signed prior to or on the effective date of the Initial Public Offering. The holders of a majority of these securities are entitled to make up to two demands that the Company registers such securities. The holders of the majority of the insider shares can elect to exercise these registration rights at any time commencing three months prior to the date on which these shares of Common Stock are to be released from escrow. In addition, the holders have certain "piggy-back" registration rights with respect to registration statements filed subsequent to the consummation of a Business Combination. The Company will bear the expenses incurred in connection with the filing of any such registration statements.

Underwriter's Agreement

The Company granted the underwriter a 45-day option to purchase up to 2,250,000 additional Units to cover over-allotments at the Initial Public Offering price, less the underwriting discounts and commissions. On July 28, 2021, the Underwriters exercised the over-allotment option in full and purchased an additional 2,250,000 Units for an aggregate purchase price of \$22,500,000.

CLEANTECH ACQUISITION CORP.
NOTES TO CONDENSED CONSOLIDATED FINANCIAL STATEMENTS
MARCH 31, 2022
(UNAUDITED)

NOTE 6. COMMITMENTS AND CONTINGENCIES (cont.)

In connection with the closing of the Initial Public Offering and subsequent exercise of the over-allotment option, the underwriter was paid a cash underwriting fee of \$0.20 per Unit, or \$3,450,000 in the aggregate.

Business Combination Marketing Agreement

The Company engaged Chardan Capital Markets, LLC as an advisor in connection with the initial Business Combination to assist the Company in holding meetings with the stockholders to discuss the potential Business Combination and the target business's attributes, introduce the Company to potential investors that are interested in purchasing the securities in connection with the potential Business Combination, assist the Company in obtaining stockholder approval for the Business Combination and assist the Company with press releases and public filings in connection with the Business Combination. The Company will pay Chardan Capital Markets, LLC a marketing fee for such services upon the consummation of the initial Business Combination in an amount equal to, in the aggregate, 3.5% of the gross proceeds of the Initial Public Offering, including any proceeds from the full or partial exercise of the underwriters' over-allotment option. As a result, Chardan Capital Markets, LLC will not be entitled to such fee unless the Company consummates the initial Business Combination. A copy of the form of Business Combination marketing agreement has been filed as an exhibit to the registration statement of which the Company's prospectus forms a part.

NOTE 7. WARRANTS LIABILITIES

As of March 31, 2022 and December 31, 2021, there were 15,800,000 (including 8,625,000 Public Warrants and 7,175,000 Private Placement Warrants) warrants outstanding.

Each whole public warrant entitles the registered holder to purchase one share of Common Stock at a price of \$11.50 per whole share, subject to adjustment as described below, at any time commencing on the later of one year after the closing of the Initial Public Offering or the consummation of an initial Business Combination. However, no public warrants will be exercisable for cash unless the Company has an effective and current registration statement covering the shares of Common Stock issuable upon exercise of the warrants and a current prospectus relating to such shares of Common Stock. Notwithstanding the foregoing, if a registration statement covering the shares of Common Stock issuable upon exercise of the public warrants is not effective within 120 days from the closing of the initial Business Combination, warrant holders may, until such time as there is an effective registration statement and during any period when the Company shall have failed to maintain an effective registration statement, exercise warrants on a cashless basis pursuant to an available exemption from registration under the Securities Act. The warrants will expire five years from the closing of the initial Business Combination at 5:00 p.m., New York City time.

The private warrants will be identical to the public warrants underlying the units being offered by the Company's prospectus except that (i) each private warrant is exercisable for one share of Common Stock at an exercise price of \$11.50 per share, and (ii) such private warrants will be exercisable for cash (even if a registration statement covering the shares of Common Stock issuable upon exercise of such warrants is not effective) or on a cashless basis, at the holder's option, and will not be redeemable by us, in each case so long as they are still held by the initial purchasers or their affiliates. The private warrants purchased by CleanTech Investments will not be exercisable more than five years from the effective date of the registration statement, of which the Company's prospectus forms a part, in accordance with FINRA Rule 5110(g)(8), as long as Chardan Capital Markets, LLC or any of its related persons beneficially own these private warrants.

The Company may call the outstanding warrants for redemption (excluding the private warrants but including any warrants already issued upon exercise of the unit purchase option), in whole and not in part, at a price of \$0.01 per warrant:

- at any time while the warrants are exercisable,
- upon not less than 30 days' prior written notice of redemption to each warrant holder,

CLEANTECH ACQUISITION CORP.
NOTES TO CONDENSED CONSOLIDATED FINANCIAL STATEMENTS
MARCH 31, 2022
(UNAUDITED)

NOTE 7. WARRANTS LIABILITIES (cont.)

- if, and only if, the reported last sale price of the shares of common stock equals or exceeds \$16.50 per share, for any 20 trading days within a 30-day trading period ending on the third business day prior to the notice of redemption to warrant holders, and
- if, and only if, there is a current registration statement in effect with respect to the shares of common stock underlying such warrants at the time of redemption and for the entire 30-day trading period referred to above and continuing each day thereafter until the date of redemption.

The right to exercise will be forfeited unless the warrants are exercised prior to the date specified in the notice of redemption. On and after the redemption date, a record holder of a warrant will have no further rights except to receive the redemption price for such holder's warrant upon surrender of such warrant.

If the Company calls the warrants for redemption as described above, the Company's management will have the option to require all holders that wish to exercise warrants to do so on a "cashless basis." In such event, each holder would pay the exercise price by surrendering the warrants for that number of shares of common stock equal to the quotient obtained by dividing (x) the product of the number of shares of common stock underlying the warrants, multiplied by the difference between the exercise price of the warrants and the "fair market value" by (y) the fair market value. The "fair market value" shall mean the average reported last sale price of the Company's common stock for the 10 trading days ending on the third trading day prior to the date on which the notice of redemption is sent to the holders of warrants. Whether the Company will exercise the option to require all holders to exercise their warrants on a "cashless basis" will depend on a variety of factors including the price of the common shares at the time the warrants are called for redemption, the Company's cash needs at such time and concerns regarding dilutive share issuances.

The exercise price and number of shares of common stock issuable on exercise of the warrants may be adjusted in certain circumstances including in the event of a share dividend, extraordinary dividend or the Company's recapitalization, reorganization, merger or consolidation. In addition, if the Company issues additional shares of common stock or equity-linked securities for capital raising purposes in connection with the closing of the initial Business Combination at a newly issued price of less than \$9.20 per share of common stock (with such issue price or effective issue price to be determined in good faith by the board of directors and, in the case of any such issuance to the Company's initial stockholders or their affiliates, without taking into account any founder shares or private warrants held by them, as applicable, prior to such issuance), the exercise price of the warrants will be adjusted (to the nearest cent) to be equal to 115% of the newly issued price and the \$16.50 per share redemption trigger price described below under will be adjusted (to the nearest cent) to be equal to 165% of the market value (the volume weighted average trading price of the common stock during the 20 trading day period starting on the trading day prior to the consummation of an initial Business Combination).

The warrants may be exercised upon surrender of the warrant certificate on or prior to the expiration date at the offices of the warrant agent, with the exercise form on the reverse side of the warrant certificate completed and executed as indicated, accompanied by full payment of the exercise price, by certified or official bank check payable to us, for the number of warrants being exercised. The warrant holders do not have the rights or privileges of holders of shares of common stock and any voting rights until they exercise their warrants and receive shares of common stock. After the issuance of shares of common stock upon exercise of the warrants, each holder will be entitled to one vote for each share held of record on all matters to be voted on by stockholders.

Except as described above, no public warrants will be exercisable for cash, and the Company will not be obligated to issue shares of common stock unless at the time a holder seeks to exercise such warrant, a prospectus relating to the shares of common stock issuable upon exercise of the warrants is current and the shares of common stock have been registered or qualified or deemed to be exempt under the securities laws of the state of residence of the holder of the warrants. Under the terms of the warrant agreement, the Company has agreed to use best efforts to meet these conditions and to maintain a current prospectus relating to the shares of common stock issuable upon exercise of the warrants until the expiration of the warrants. However, the Company cannot assure you that it will be able to do so

CLEANTECH ACQUISITION CORP.
NOTES TO CONDENSED CONSOLIDATED FINANCIAL STATEMENTS
MARCH 31, 2022
(UNAUDITED)

NOTE 7. WARRANTS LIABILITIES (cont.)

and, if the Company does not maintain a current prospectus relating to the shares of common stock issuable upon exercise of the warrants, holders will be unable to exercise their warrants, and the Company will not be required to settle any such warrant exercise. If the prospectus relating to the shares of common stock issuable upon the exercise of the warrants is not current or if the common stock is not qualified or exempt from qualification in the jurisdictions in which the holders of the warrants reside, the Company will not be required to net cash settle or cash settle the warrant exercise, the warrants may have no value, the market for the warrants may be limited, and the warrants may expire worthless.

No fractional shares will be issued upon exercise of the warrants. If, upon exercise of the warrants, a holder would be entitled to receive a fractional interest in a share, the Company will, upon exercise, round down to the nearest whole number the number of shares of common stock to be issued to the warrant holder.

The Company accounts for the 15,800,000 warrants issued in connection with the Initial Public Offering in accordance with the guidance contained in ASC 815-40. Such guidance provides that because the warrants do not meet the criteria for equity treatment thereunder, each warrant must be recorded as a liability.

The accounting treatment of derivative financial instruments required that the Company record the warrants as derivative liabilities at fair value upon the closing of the Initial Public Offering. The Public Warrants were allocated a portion of the proceeds from the issuance of the Units equal to its fair value. This warrant liabilities are subject to re-measurement at each balance sheet date. With each such re-measurement, the warrant liability will be adjusted to its current fair value, with the change in fair value recognized in the Company's statement of operations. The Company will reassess the classification at each balance sheet date. If the classification changes as a result of events during the period, the warrants will be reclassified as of the date of the event that causes the reclassification.

NOTE 8. STOCKHOLDERS' DEFICIT

Preferred stock — The Company is authorized to issue 1,000,000 shares of \$0.0001 par value preferred stock. As of March 31, 2022 and December 31, 2021, there were no shares of preferred stock issued or outstanding.

Common stock — On July 16, 2021, the Company amended its Amended and Restated Certificate of Incorporation such that the Company is authorized to issue 200,000,000 shares of common stock with a par value of \$0.0001 per share. As of March 31, 2022 and December 31, 2021, there were 21,562,500 shares of common stock outstanding, including 17,250,000 common stock subject to possible redemption.

Holders of record of common stock are entitled to one vote for each share held on all matters to be voted on by stockholders. In connection with any vote held to approve the initial Business Combination, insiders, officers and directors, have agreed to vote their respective shares of common stock owned by them immediately prior to the Initial Public Offering, including both the insider shares and any shares acquired in the Initial Public Offering or following the Initial Public Offering in the open market, in favor of the proposed Business Combination.

Rights — Except in cases where the Company is not the surviving company in a Business Combination, each holder of a right will automatically receive one-twentieth (1/20) of a share of common stock upon consummation of the Business Combination, even if the holder of a right converted all shares held by him, her or it in connection with the Business Combination or an amendment to the Company's Certificate of Incorporation with respect to its pre-business combination activities. In the event that the Company will not be the surviving company upon completion of the Business Combination, each holder of a right will be required to affirmatively convert his, her or its rights in order to receive the one-twentieth (1/20) of a share of common stock underlying each right upon consummation of the Business Combination. No additional consideration will be required to be paid by a holder of rights in order to receive his, her or its additional share of common stock upon consummation of the Business Combination. The shares issuable upon exchange of the rights will be freely tradable (except to the extent held by affiliates of the Company). If the Company

CLEANTECH ACQUISITION CORP.
NOTES TO CONDENSED CONSOLIDATED FINANCIAL STATEMENTS
MARCH 31, 2022
(UNAUDITED)

NOTE 8. STOCKHOLDERS' DEFICIT (cont.)

enters into a definitive agreement for a Business Combination in which the Company will not be the surviving entity, the definitive agreement will provide for the holders of rights to receive the same per share consideration the holders of shares of common stock will receive in the transaction on an as-converted into common stock basis.

The Company will not issue fractional shares in connection with an exchange of rights. As a result, the holders of the rights must hold rights in multiples of 20 in order to receive shares for all of the holders' rights upon closing of a Business Combination. If the Company is unable to complete an initial Business Combination within the required time period and the Company liquidates the funds held in the Trust Account, holders of rights will not receive any of such funds with respect to their rights, nor will they receive any distribution from the Company's assets held outside of the Trust Account with respect to such rights, and the rights will expire worthless. Additionally, in no event will the Company be required to net cash settle the rights. Accordingly, the rights may expire worthless.

NOTE 9. FAIR VALUE MEASUREMENTS

The following tables presents information about the Company's financial assets and liabilities that are measured at fair value on a recurring basis as of March 31, 2022 and December 31, 2021, and indicates the fair value hierarchy of the valuation inputs the Company utilized to determine such fair value:

Description	Amount at Fair Value	Level 1	Level 2	Level 3
March 31, 2022				
Assets				
Investments held in Trust Account:				
Money Market investments	\$ 174,247,973	\$ 174,247,973	\$ —	\$ —
Liabilities				
Warrant liabilities – Public Warrants	\$ 3,622,500	\$ 3,622,500	\$ —	\$ —
Warrant liabilities – Private Placement Warrants	\$ 1,937,250	\$ —	\$ —	\$ 1,937,250
December 31, 2021				
Assets				
Investments held in Trust Account:				
Money Market investments	\$ 174,230,428	\$ 174,230,428	\$ —	\$ —
Liabilities				
Warrant liabilities – Public Warrants	\$ 5,175,000	\$ 5,175,000	\$ —	\$ —
Warrant liabilities – Private Placement Warrants	\$ 2,798,250	\$ —	\$ —	\$ 2,798,250

The Company utilized a Monte Carlo simulation model for the initial valuation of the Public Warrants, and the publicly-traded value for the subsequent valuation of the Public Warrants. The measurement of the Public Warrants as of March 31, 2022 and December 31, 2021 is classified as Level 1 due to the use of an observable market quote in an active market under the ticker CLAQW. The quoted price of the Public Warrants was \$ 0.42 and \$0.60 per warrant as of March 31, 2022 and December 31, 2021, respectively.

The Company utilizes a Black-Scholes Option Pricing Model to value the Private Placement Warrants at each reporting period, with changes in fair value recognized in the statement of operations. The estimated fair value of the warrant liability is determined using Level 3 inputs. Inherent in a Black-Scholes Option Pricing Model are assumptions related to expected share-price volatility, expected life, risk-free interest rate and dividend yield. For the initial valuation, the Company estimated volatility based on research on comparable companies with the same type of warrants along with the implied volatilities shortly after they start trading. Significant increases (decreases) in the expected volatility in isolation would result in a significantly higher (lower) fair value measurement. The risk-free interest rate is based

CLEANTECH ACQUISITION CORP.
NOTES TO CONDENSED CONSOLIDATED FINANCIAL STATEMENTS
MARCH 31, 2022
(UNAUDITED)

NOTE 9. FAIR VALUE MEASUREMENTS (cont.)

on the U.S. Treasury zero-coupon yield curve on the grant date for a maturity similar to the expected remaining life of the warrants. The expected life of the warrants is assumed to be equivalent to their remaining contractual term. The dividend rate is based on the historical rate, which the Company anticipates to remain at zero.

Transfers to/from Levels 1, 2 and 3 are recognized at the end of the reporting period. The estimated fair value of the Public Warrants transferred from a Level 3 measurement to a Level 1 fair value measurement in September 2021 after the Public Warrants were separately listed and traded.

The following table provides the significant inputs to the Black-Scholes Option Pricing Model fair value of the Private Placement Warrants:

	As of March 31, 2022	As of December 31, 2021
Stock price	\$ 10.05	\$ 9.96
Strike price	\$ 11.50	\$ 11.50
Probability of completing a Business Combination	100.0%	100.0%
Dividend yield	—%	—%
Term (in years)	4.3	4.6
Volatility	4.9%	8.7%
Risk-free rate	2.4%	1.2%
Discount for lack of marketability	—%	—%
Fair value of warrants	\$ 0.27	\$ 0.39

The following table provides a summary of the changes in the fair value of the Company's Level 3 financial instruments that are measured at fair value on a recurring basis:

Fair value as of December 31, 2020	\$ —
Initial measurement of Public Warrants and Private Placement Warrants at July 19, 2021	7,980,000
Initial measurement of over-allotment warrants	1,071,000
Transfer of Public Warrants to Level 1 measurement	(5,175,000)
Change in fair value	<u>(1,077,750)</u>
Fair value as of December 31, 2021	2,798,250
Change in fair value	<u>(861,000)</u>
Fair value as of March 31, 2022	<u>\$ 1,937,250</u>

The Company recognized losses in connection with the change in the fair value of warrant liabilities of \$2,413,500 and \$0 in the unaudited condensed consolidated statements of operations during the three months ended March 31, 2022 and March 31, 2021, respectively.

NOTE 10. SUBSEQUENT EVENTS

The Company evaluated subsequent events and transactions that occurred after the balance sheet date up to the date that the unaudited condensed consolidated financial statements were issued. Based upon this review, other than those items disclosed below, the Company did not identify any subsequent events that would have required adjustment or disclosure in the unaudited condensed consolidated financial statements.

On May 5, 2022, the Company entered into a Promissory Note with the Sponsor (the "Third Promissory Note") to which the Company could borrow up to an aggregate of \$133,000. The Third Promissory Note is non-interest bearing and payable upon the earlier of (i) completion of the initial Business Combination or (ii) the date on which the Company determines that it is unable to effect a Business Combination. On May 5, 2022, the Company drew down \$133,000 under the Third Promissory Note.

REPORT OF INDEPENDENT REGISTERED PUBLIC ACCOUNTING FIRM

To the Board of Directors and Stockholders
Nauticus Robotics, Inc.

Opinion on the Financial Statements

We have audited the accompanying balance sheets of Nauticus Robotics, Inc. (the “Company”) as of December 31, 2021 and 2020, the related statements of operations, changes in stockholders’ equity (deficit), and cash flows for the years then ended, and the related notes to financial statements (collectively referred to as the “financial statements”). In our opinion, the financial statements present fairly, in all material respects, the financial position of the Company as of December 31, 2021 and 2020, and the results of its operations and its cash flows for the years then ended, in conformity with accounting principles generally accepted in the United States of America.

Basis for Opinion

These financial statements are the responsibility of the Company’s management. Our responsibility is to express an opinion on these financial statements based on our audits. We are a public accounting firm registered with the Public Company Accounting Oversight Board (United States) (“PCAOB”) and are required to be independent with respect to the Company in accordance with the U.S. federal securities laws and the applicable rules and regulations of the Securities and Exchange Commission and the PCAOB.

We conducted our audits in accordance with the standards of the PCAOB. Those standards require that we plan and perform the audit to obtain reasonable assurance about whether the financial statements are free of material misstatement, whether due to error or fraud. The Company is not required to have, nor were we engaged to perform, an audit of its internal control over financial reporting. As part of our audits we are required to obtain an understanding of internal control over financial reporting, but not for the purpose of expressing an opinion on the effectiveness of the entity’s internal control over financial reporting. Accordingly, we express no such opinion.

Our audits included performing procedures to assess the risks of material misstatement of the financial statements, whether due to error or fraud, and performing procedures that respond to those risks. Such procedures included examining, on a test basis, evidence regarding the amounts and disclosures in the financial statements. Our audits also included evaluating the accounting principles used and significant estimates made by management, as well as evaluating the overall presentation of the financial statements. We believe that our audits provide a reasonable basis for our opinion.

Critical Audit Matter

The critical audit matter communicated below is a matter arising from the audit of the financial statements that was communicated or required to be communicated to the board of directors and that: (1) relates to accounts or disclosures that are material to the financial statements and (2) involved especially challenging, subjective, or complex judgments. The communication of the critical audit matter does not alter in any way our opinion on the financial statements, taken as a whole, and we are not, by communicating the critical audit matter below, providing a separate opinion on the critical audit matter or on the accounts or disclosures to which it relates.



Revenue Recognition

Description of the Matter

As discussed in Note 2 to the financial statements, the Company's service contracts generally recognize revenue over time as there is a continuous transfer of control to the customer.

The Company uses the amount of cost incurred under the contract as a measure of progress towards completion, and revenue recognized is measured principally by the costs incurred and accrued to date for each contract as a percentage of the estimated total cost for each contract at completion. Contract costs include all direct material, labor, and indirect costs related to contract performance. Changes in job performance, job conditions, estimated contract costs and profitability and final contract settlements may result in revisions to costs and income, and the effects of these revisions are recognized prospectively in the period in which the revisions are determined. This measurement and comparison process requires updates to the estimate of total costs to complete the contract, and these updates include subjective assessments and judgments.

We identified the Company's estimation of the costs to complete each contract as a critical audit matter due to the high degree of auditor judgment and the increased extent of effort that was required when performing audit procedures to evaluate the reasonableness of management's estimates and assumptions related to the estimate of costs to complete contracts recognized over time.

How We Addressed the Matter in Our Audit

Our audit procedures related to forecasts of estimated costs to complete contracts recognized over time included the following, among others:

- We selected a sample of contracts and obtained and inspected the executed contracts and contract amendments to validate existence and understand the scope of each contract.
- We gained an understanding of controls related to management's process to estimate future costs to complete contracts recognized over time.
- We performed an analysis of how each step within the accounting guidance is addressed for each revenue transaction selected in our substantive test of details.

/s/ Whitley Penn LLP

We have served as the Company's auditor since 2021.

Houston, Texas

March 24, 2022, except for Note 13, as to which the date is April 27, 2022

Nauticus Robotics, Inc.
Balance Sheets

	December 31,	
	2021	2020
Assets		
Current Assets		
Cash and cash equivalents	\$ 20,952,867	\$ 3,298,180
Restricted certificate of deposit	251,236	251,421
Accounts receivable	794,136	72,735
Contract assets	893,375	61,886
Other current assets	277,444	1,500
Total Current Assets	<u>23,169,058</u>	<u>3,685,722</u>
Property and equipment, net	1,437,311	879,921
Right-of-use asset – operating lease	513,763	719,729
Other assets	47,240	47,240
Total Assets	<u>\$ 25,167,372</u>	<u>\$ 5,332,612</u>
Liabilities and Stockholders' Equity (Deficit)		
Current Liabilities		
Accounts payable	\$ 1,400,514	\$ 60,073
Accrued payroll	411,008	178,933
Accrued interest	703,544	28,777
Other accrued liabilities	90,000	50,149
Contract liabilities	373,791	1,807,161
Operating lease liabilities – current	353,598	425,332
Notes payable – current	10,250,000	484,836
Notes payable, related parties – current	3,000,000	3,000,000
Total Current Liabilities	<u>16,582,455</u>	<u>6,035,261</u>
Operating lease liabilities – long-term	467,208	726,072
Notes payable – long-term	14,708,333	—
Other liabilities	20,833	—
Total Liabilities	<u>31,778,829</u>	<u>6,761,333</u>
Commitments and Contingencies		
Stockholders' Equity (Deficit)		
Series A preferred stock, \$0.01 par value; 334,800 shares authorized, issued, and outstanding	3,348	3,348
Series B preferred stock, \$0.01 par value; 725,426 shares authorized, issued, and outstanding	7,254	7,254
Common stock, \$0.01 par value; 10,000,000 shares authorized, 952,200 and 950,000 shares issued, respectively, and 680,600 and 678,400 shares outstanding, respectively	9,522	9,500
Treasury stock, at cost; 271,600 shares	(944,927)	(944,927)
Additional paid-in capital	34,157,877	24,213,006
Accumulated deficit	(39,844,531)	(24,716,902)
Total Stockholders' Equity (Deficit)	<u>(6,611,457)</u>	<u>(1,428,721)</u>
Total Liabilities and Stockholders' Equity (Deficit)	<u>\$ 25,167,372</u>	<u>\$ 5,332,612</u>

The accompanying notes are an integral part of these financial statements.

Nauticus Robotics, Inc.
Statements of Operations

	For the year ended December 31,	
	2021	2020
Revenue		
Service	\$ 7,854,068	\$ 3,184,629
Product	242,637	—
Service – related party	332,767	619,883
Product – related party	162,068	189,928
Total revenue	<u>8,591,540</u>	<u>3,994,440</u>
Costs and Expenses		
Cost of revenue (exclusive of items shown separately below)	6,850,248	4,059,991
Depreciation	365,097	400,432
Research and development	3,533,713	4,951,619
General and administrative	4,362,400	3,319,455
Total costs and expenses	<u>15,111,458</u>	<u>12,731,497</u>
Operating loss	(6,519,918)	(8,737,057)
Other expense (income)		
Other income	(1,601,568)	(1,609,962)
Loss on extinguishment of debt	9,484,113	—
Interest expense, net	725,166	66,943
Total other expense	<u>8,607,711</u>	<u>(1,543,019)</u>
Net loss	<u>\$ (15,127,629)</u>	<u>\$ (7,194,038)</u>
Earnings (loss) per common share		
Basic	\$ (22.30)	\$ (10.60)
Diluted	\$ (22.30)	\$ (10.60)
Basic weighted average shares outstanding	678,406	678,400
Diluted weighted average shares outstanding	678,406	678,400

The accompanying notes are an integral part of these financial statements.

Nauticus Robotics, Inc.
Statements of Changes in Stockholders' Equity (Deficit)

	Series A Preferred Stock		Series B Preferred Stock		Common Stock		Treasury Stock	Additional Paid-in Capital	Accumulated Deficit	Total Stockholders' Equity (Deficit)
	Shares	Amount	Shares	Amount	Shares	Amount				
Balance at January 1, 2020	334,800	\$ 3,348	725,426	\$ 7,254	950,000	\$ 9,500	\$(944,927)	\$ 23,795,703	\$(17,522,864)	\$ 5,348,014
Stock-based compensation	—	—	—	—	—	—	—	417,303	—	417,303
Net loss	—	—	—	—	—	—	—	—	(7,194,038)	(7,194,038)
Balance at December 31, 2020	334,800	\$ 3,348	725,426	\$ 7,254	950,000	\$ 9,500	\$(944,927)	\$ 24,213,006	\$(24,716,902)	\$(1,428,721)
Stock-based compensation	—	—	—	—	—	—	—	425,580	—	425,580
Loss on extinguishment of debt	—	—	—	—	—	—	—	9,484,113	—	9,484,113
Exercise of stock options	—	—	—	—	2,200	22	—	35,178	—	35,200
Net loss	—	—	—	—	—	—	—	—	(15,127,629)	(15,127,629)
Balance at December 31, 2021	334,800	\$ 3,348	725,426	\$ 7,254	952,200	\$ 9,522	\$(944,927)	\$ 34,157,877	\$(39,844,531)	\$(6,611,457)

The accompanying notes are an integral part of these financial statements.

Nauticus Robotics, Inc.
Statements of Cash Flows

	For the year ended December 31,	
	2021	2020
Cash Flows From Operating Activities		
Net loss	\$ (15,127,629)	\$ (7,194,038)
Adjustments to reconcile net loss to net cash from operating activities:		
Depreciation	365,097	400,432
Stock-based compensation	425,580	417,303
Amortization of debt discount	29,166	—
Loss on extinguishment of debt	9,484,113	—
Non-cash impact of lease accounting	205,966	238,456
Changes in operating assets and liabilities:		
Accounts receivable	(721,401)	150,102
Contract assets	(831,489)	318,719
Other assets	(275,759)	2,491
Accounts payable and accrued liabilities	2,287,134	(290,321)
Operating lease liabilities	(330,598)	(350,080)
Contract liabilities	(1,433,370)	1,807,161
Net cash from operating activities	<u>(5,923,190)</u>	<u>(4,499,775)</u>
Cash Flows From Investing Activities		
Additions to property and equipment	(922,487)	(3,246)
Proceeds from short-term investments	—	999,728
Net cash from investing activities	<u>(922,487)</u>	<u>996,482</u>
Cash Flows From Financing Activities		
Proceeds from notes payable	24,950,000	—
Proceeds from note payable, related parties	—	3,000,000
Proceeds from line of credit	—	750,000
Proceeds from exercise of stock options	35,200	—
Payments of note payable	(484,836)	(460,091)
Payments of line of credit	—	(750,000)
Net cash from financing activities	<u>24,500,364</u>	<u>2,539,909</u>
Net change in cash and cash equivalents	17,654,687	(963,384)
Cash and Cash Equivalents, beginning of year	3,298,180	4,261,564
Cash and Cash Equivalents, end of year	<u>\$ 20,952,867</u>	<u>\$ 3,298,180</u>
Supplemental cash flow information		
Cash paid for interest	<u>\$ 25,909</u>	<u>\$ 49,133</u>
Cash paid for taxes	<u>\$ —</u>	<u>\$ —</u>
Noncash financing activities:		
Loan commitment fee	<u>\$ (300,000)</u>	<u>\$ —</u>

The accompanying notes are an integral part of these financial statements.

Nauticus Robotics, Inc.
Notes to Financial Statements
For the Years Ended December 31, 2021 and 2020

1. Description of the Business

Nauticus Robotics, Inc. (“Nauticus”, “Nauticus Robotics”, “Company”, “our”, or “we”) was initially incorporated as Houston Mechatronics, Inc. on March 27, 2014 in the State of Texas. Effective November 24, 2021, the Company changed its legal name to Nauticus Robotics, Inc. Nauticus’ principal corporate offices are located in Webster, Texas. The Company is developing an ecosystem of ocean robots that are controlled through an AI-driven cloud software platform which enables a sliding scale spectrum of autonomous operations — from direct operator control to complete hands-off, robot self-sufficient control. Instead of the conventional tethered connection between the operator and the subsea robot, Nauticus has developed an acoustic communication networking, compression, and protocols that allows the robot to perform its tasks without a direct, cabled connection. This offering permits significant operational flexibility and cost savings over the methods currently deployed in the marketplace.

Impact of COVID-19 Pandemic on Business — The global spread of COVID-19 has created significant market volatility and economic uncertainty and disruption during 2020. The Company was adversely affected by the deterioration and increased uncertainty in the macroeconomic outlook as a result of the impact of COVID-19. We continue to actively monitor the situation and may take further actions altering our business operations that we determine are in the best interests of our employees, customers, suppliers, and stakeholders, or as required by federal, state, or local authorities.

Liquidity — The Company has had recurring losses and negative cash flows since inception. As such, the Company has been dependent on debt and equity funding to meet its development efforts. The Company continues to develop its principal products and conducts extensive research and development activities. At December 31, 2021, the Company had net working capital of \$6,586,603.

On October 15, 2021, the Company signed a purchase order with Triumph Subsea Construction Limited for the purchase of four Aquanaut systems over a period from September 2022 through January 2025 for a total of \$54 million. The Company is also in late-stage discussions with customers for additional product sales.

On December 16, 2021, Nauticus entered into a merger agreement with CleanTech Acquisition Corporation (“CleanTech”), a special purpose acquisition company. In this agreement, Nauticus agreed to a business combination that is intended to lead to its public stock listing on the NASDAQ in May 2022. CleanTech brings approximately \$260 million in sponsored investment and public investment in private equity funding to the business combination. Although this level of funding is potentially available, a threshold of \$50 million has been established in the merger documents as the minimum cash position for internal planning purposes. Concurrent with the signing of the SPAC merger agreement, Nauticus received a \$15 million loan from RCB Equities #1, LLC to provide advanced funding against the business plan.

Management believes that with the revenue from its existing and new contracts, the ability to reduce costs as necessary, and the pending merger with CleanTech, the Company will have sufficient cash from operations to meet its obligations for at least one year from the issuance date of this report.

2. Summary of Significant Accounting Policies

Basis of Presentation — These financial statements have been prepared in accordance with accounting principles generally accepted in the United States of America (“GAAP”).

Use of Estimates — The preparation of financial statements in conformity with GAAP requires management to make estimates and assumptions that affect the reported amounts of assets and liabilities and disclosure of contingent assets and liabilities at the date of the financial statements and the reported amounts of revenues and expenses during the period. Significant items subject to such estimates and assumptions include the (i) estimates of future costs to complete customer contracts recognized over time, (ii) valuation allowances for deferred income tax assets, and (iii) valuation of stock-based compensation. Actual results could differ from those estimates.

Cash and Cash Equivalents — The Company classifies all highly-liquid instruments with an original maturity of three months or less as cash equivalents. The Company maintains cash and cash equivalents in bank deposit accounts, which at times may exceed federally insured limits of \$250,000. Historically, the Company has not experienced any losses in such accounts.

Nauticus Robotics, Inc.
Notes to Financial Statements
For the Years Ended December 31, 2021 and 2020

2. Summary of Significant Accounting Policies (cont.)

Restricted Certificate of Deposit — The restricted certificate of deposit as of December 31, 2021 is held with a bank and is used as a guarantee against corporate credit cards. Previously, the restricted certificate of deposit was held with a bank and was used as collateral for its revolving line of credit. This revolving line of credit expired on June 21, 2021 and was not renewed.

Accounts Receivable — Trade credit is generally extended on a short-term basis in the normal course of business. If necessary, the Company establishes an allowance for doubtful accounts to provide for the estimated amount of accounts receivable that will not be collected which is based on an analysis of specific customers, taking into consideration the age of past due accounts and an assessment of the customer's ability to pay. Accounts receivable outstanding longer than contractual terms, generally up to 90 days, are considered past due. Accounts deemed uncollectible are applied against the allowance for doubtful accounts. An allowance for doubtful accounts was not needed as of December 31, 2021 or 2020 and there was no bad debt expense for the years ended December 31, 2021 or 2020.

Property and Equipment — Property and equipment is recorded at cost and depreciated using the straight-line method. Expenditures which extend the useful lives of existing property and equipment are capitalized. Those costs which do not extend the useful lives are expensed as incurred. Upon disposition, the cost and accumulated depreciation are removed and any gain or loss on the disposal is reflected in the statements of operations.

Impairment of Long Lived Assets — The Company reviews long-lived assets for potential impairment when events or changes in circumstances indicate that the carrying amount of the asset may not be recoverable. In this assessment, future pre-tax cash flows (undiscounted) resulting from the use of the asset and its eventual disposal are estimated. If the undiscounted future cash flows are less than the carrying amount of the asset, an impairment loss is recognized for the difference between its carrying value and estimated fair value.

Segment Reporting — Our operations represent a single segment because each revenue stream possesses similar production methods, distribution methods, and customer quality and consumption characteristics, resulting in similar long-term expected financial performance.

To date, Nauticus Robotics has operated as a single segment in providing technical and engineering services and products for use offshore. We have entered into customer contracts for products and/or services in our development portfolio where our technical and engineering expertise are applied. Each of these contracts generate revenue for the goods and/or services contracted, independent of other contractual arrangements found within such contracts, and, as such, the contractual revenues are aggregated as single-source revenue stream. These revenue streams are not separate operating segments because there are no measures of their operating performance other than direct revenue and cost of revenue. This limited disaggregated financial information is not utilized by our Chief Executive Officer in making resource allocations or performance assessments. Our Chief Executive Officer uses non-financial information and consolidated financial information to allocate resources and assess performance of the Company. The Company does not provide incentive compensation for performance below that of the consolidated level.

Revenue Recognition — The Company's primary sources of revenue are from providing technology and engineering services and products to the offshore industry and governmental entities. Revenue is generated pursuant to contractual arrangements to design and develop subsea robots and software and to provide related engineering, technical, and other services according to the specifications of the customers. These contracts can be service sales (cost plus fixed fee or firm fixed fee) or product sales and typically have terms of up to 18 months. The Company has limited product sales as its core products are still under development. Product sales to date have been for HaloGuard, a red zone monitoring solution we developed.

A performance obligation is a promise in a contract to transfer distinct goods or services to a customer. The products and services in our contracts are typically not distinct from one another. Accordingly, our contracts are typically accounted for as one performance obligation.

The Company's performance obligations under service agreements generally are satisfied over time as the service is provided. Revenue under these contracts is recognized over time using an input measure of progress (typically costs incurred to date relative to total estimated costs at completion). This requires management to make significant

Nauticus Robotics, Inc.
Notes to Financial Statements
For the Years Ended December 31, 2021 and 2020

2. Summary of Significant Accounting Policies (cont.)

estimates and assumptions to estimate contract sales and costs associated with its contracts with customers. At the outset of a long-term contract, the Company identifies risks to the achievement of the technical, schedule and cost aspects of the contract. Throughout the contract term, on at least a quarterly basis, we monitor and assess the effects of those risks on its estimates of sales and total costs to complete the contract. Changes in these estimates could have a material effect on the Company's results of operations.

Cost plus fixed fee contracts are largely used for development projects. Cost plus fixed fee contracts revenue totaled \$3,109,055 in 2021 and \$3,333,989 in 2020.

Firm-fixed price contracts provide products or services generally over an agreed upon time frame for a predetermined amount. Fixed-price contracts revenue totaled \$5,482,485 in 2021 and \$660,451 in 2020. Firm-fixed price contracts present the risk of unreimbursed cost overruns, potentially resulting in lower-than-expected contract profits and margins. This risk is generally lower for cost plus fixed fee contracts which, as a result, generally have a lower margin.

In June 2021 Nauticus Robotics signed a Subcontractor Agreement with an unrelated third party to provide Engineering, Design, Development and Other Services which also includes a lease for an Aquanaut vehicle ("Vehicle Lease"). The Vehicle Lease is for a total of \$2,270,000, or \$126,111 per month for 18 months. Service revenue includes \$756,666 of equipment rental income in 2021 recognized based on the contractual cash rental payments for the period.

The lease is an operating lease as defined by ASC 842, and revenue will be recognized on a straightline basis over the remaining term of the lease during the year ending December 31, 2022 as follows:

Minimum Future Rental Income

Year Ended December 31, 2022	1,513,334
Thereafter	—
Total	1,513,334

Performance obligations for product sales typically are satisfied at a point in time. This occurs when control of the products is transferred to the customer, which generally is when title and risk of loss have passed to the customer.

Unfulfilled Performance Obligations

As of December 31, 2021, we expect to recognize approximately \$67 million of revenue in future periods from unfulfilled performance obligations from existing contracts with customers including \$54 million that relates to the Triumph Subsea Construction Limited purchase order as described in Note 1. We expect to recognize revenue of approximately \$18 million from our remaining performance obligations over the next 12 months, including \$7.7 million related to the Triumph Subsea Construction Limited, with the remaining balance recognized thereafter. If any of our contracts were to be modified or terminated, the expected value of the unfulfilled performance obligations of such contracts would be reduced.

As of January 1, 2020, the Company had a balance of \$222,837 in accounts receivable, \$380,605 in contract assets, and \$0 in contract liabilities.

Accounts receivables at December 31, 2021 totaled \$794,136 due from customers for contract billings and is expected to be collected in 2022. At December 31, 2020, accounts receivable totaled \$72,735. The increase in accounts receivable at December 31, 2021 as compared with the prior year corresponds to the higher revenue recognized in 2021 from newer customer contracts.

Contract assets include unbilled amounts typically resulting from sales under contracts when the cost-to-cost method of revenue recognition is utilized and revenue recognized exceeds the amount billed to the customer. Contract assets are recorded at the net amount expected to be billed and collected. Contract assets increased from \$61,886 as of December 31, 2020 to \$893,375 as of December 31, 2021, primarily due to the recognition of revenue related to the satisfaction or partial satisfaction of performance obligations for two contracts for which we have not yet billed our customers as of December 31, 2021. We expect to bill our customers for the December 31, 2021 contract assets during 2022.

Nauticus Robotics, Inc.
Notes to Financial Statements
For the Years Ended December 31, 2021 and 2020

2. Summary of Significant Accounting Policies (cont.)

Contract liabilities include billings in excess of revenue recognized and accrual of certain unsatisfied performance obligations. Contract liabilities decreased from \$1,807,161 as of December 31, 2020 to \$373,791 as of December 31, 2021. The contract liability amount at December 31, 2021 was comprised of unsatisfied remaining performance obligations including \$306,791 of billings in excess of revenue recognized and \$67,000 for contract completion obligations associated with a customer contract for a modified Aquanaut vehicle. These amounts were subsequently recognized in the statements of operations during first quarter of 2022. In 2020, we received a customer down payment of \$1,807,161 for a service contract. This entire unsatisfied performance obligation at December 31, 2020 was recognized as revenue in 2021.

Leases — The Company's lease arrangements are operating leases which are capitalized on the balance sheet as right-of-use ("ROU") assets and obligations. Right-of-use ("ROU") assets represent our right to use an underlying asset for the lease term and lease liabilities represent our obligation to make lease payments arising from the lease. These are recognized at the lease commencement date based on the present value of payments over the lease term. If leases do not provide for an implicit rate, we use our incremental borrowing rate based on the estimated rate of interest for collateralized borrowing over a similar term as the lease payments. Lease expense for operating leases is recognized on a straight-line basis over the lease term.

Stock-Based Compensation — The Company accounts for employee stock-based compensation using the fair value method. Compensation cost for equity incentive awards is based on the fair value of the equity instrument generally on the date of grant and is recognized over the requisite service period.

The Company's policy is to issue new shares upon the exercise or conversion of options and recognize option forfeitures as they occur.

Fair Value Measurements — Fair value is defined as the price that would be received to sell an asset or paid to transfer a liability in an orderly transaction between market participants at the measurement date. The three levels related to fair value measurements are as follows:

- Level 1 — Observable inputs such as quoted prices in active markets for identical assets or liabilities.
- Level 2 — Observable inputs other than quoted prices included in Level 1, such as quoted prices for similar assets and liabilities in active markets; quoted prices for identical or similar assets and liabilities in markets that are not active or other inputs that are observable or can be corroborated by observable market data.
- Level 3 — Unobservable inputs that are supported by little or no market activity and that are significant to the fair value of the assets or liabilities. This includes certain pricing models, discounted cash flow methodologies and similar techniques that use significant unobservable inputs.

The estimated fair values of accounts receivable, contract assets, accounts payable, accrued expenses, and indebtedness with unrelated parties approximate their carrying amounts due to the relatively short maturity or time to maturity of these instruments. Notes payable with related parties may not be arms-length transactions and therefore, may not reflect fair value.

The Company's non-financial assets measured at fair value on non-recurring basis include stock-based compensation awards. Financial assets measured at fair value on a non-recurring basis include the Company's convertible notes as a result of a modification treated as an extinguishment of debt for accounting purposes. These are considered Level 3 measurements as they involve significant unobservable inputs.

Income Taxes — Deferred tax assets and liabilities are recognized for the future tax consequences attributable to differences between the financial statement carrying amounts of existing assets and liabilities and their respective tax bases and operating loss and tax credit carryforwards. Deferred tax assets and liabilities are measured using enacted tax rates. The effect on deferred tax assets and liabilities of a change in tax rates is recognized in income in the period that includes the enactment date. In assessing the realizability of deferred tax assets, management considers whether it is more-likely-than-not that some portion or all of the deferred tax assets will not be realized. The ultimate realization of deferred tax assets is dependent upon the generation of future taxable income during the periods in which those temporary differences become deductible. Management considers the scheduled reversal of deferred tax

Nauticus Robotics, Inc.
Notes to Financial Statements
For the Years Ended December 31, 2021 and 2020

2. Summary of Significant Accounting Policies (cont.)

asset (including the impact of available carryback and carryforward periods), projected future taxable income, and tax-planning strategies in making this assessment. A valuation allowance for deferred tax assets is recorded when it is more likely than not that the benefit from the deferred tax asset will not be realized.

The Company recognizes the effect of income tax positions only if those positions are more likely than not of being sustained. Recognized income tax positions are measured at the largest amount that is greater than 50% likely of being realized. Changes in recognition or measurement are reflected in the period in which a change in judgment occurs. The Company had no material uncertain tax positions as of December 31, 2021 or 2020.

The Company is subject to the Texas margin tax; however, tax expense was zero for the years ended December 31, 2021 and 2020.

Foreign Currency Translation — Nauticus purchases certain materials and equipment from foreign companies and these transactions are generally denominated in the vendors' local currency. The Company recorded \$470 and \$0 of foreign currency transaction gains for the years ended December 31, 2021 and 2020, respectively.

Earnings (Loss) per Share — Basic earnings per share is computed by dividing income by the weighted average number of shares of common stock outstanding during the period. Diluted earnings per share is computed in the same manner as basic earnings per share except that the denominator is increased to include the number of additional shares of common stock that could have been outstanding assuming the exercise of stock options (determined using the treasury stock method) and conversion of convertible debt.

Major Customer and Concentration of Credit Risk — The Company has a limited number of customers. During 2021, sales to a Large Confidential Government Contractor accounted for 89% of total revenue and the total balance due from this customer as of December 31, 2021 made up 82% of accounts receivable. During 2020, sales to this same Large Confidential Government Contractor accounted for 61% of total revenue, sales to Transocean accounted for 20% of total revenue, and sales to ONR accounted for 17% of total revenue. The total balances due from these customers as of December 31, 2020 made up 100% of accounts receivable. No other customer represented more than 10% of revenue in either year.

Reclassifications — Financial statements presented for prior periods include reclassifications that were made to conform to the current-year presentation.

Recent Accounting Pronouncements — In August 2020, the Financial Accounting Standards Board issued Accounting Standards Update ("ASU") No. 2020-06, *Debt — Debt with Conversion and Other Options (Subtopic 470-20) and Derivatives and Hedging Contracts in Entity's Own Equity (Subtopic 815-40): Accounting for Convertible Instruments and Contracts in an Entity's Own Equity*. ASU 2020-06 simplifies the accounting for convertible instruments by reducing the number of accounting models for convertible debt instruments and convertible preferred stock. Limiting the accounting models results in fewer embedded conversion features being separately recognized from the host contract as compared with current GAAP. Convertible instruments that continue to be subject to separation models are (1) those with embedded conversion features that are not clearly and closely related to the host contract, which meet the definition of a derivative, and that do not qualify for a scope exception from derivative accounting and (2) convertible debt instruments issued with substantial premiums for which the premiums are recorded as paid-in capital. ASU 2020-06 also amends the guidance for the derivatives scope exception for contracts in an entity's own equity to reduce form-over-substance-based accounting conclusions.

The Company elected to early adopt ASU 2020-06 as of January 1, 2021 using the modified retrospective method. Adoption of this new guidance had no impact on prior year retained earnings as we have stated the convertible debt instruments at their face value in prior period financial statements without bifurcation. Adoption of this guidance had no impact on Company financial statements at the date of adoption but is applicable to newly issued instruments.

In June 2016, the FASB issued ASU2016-13, *Financial Instruments — Credit Losses*, which replaces the existing incurred loss impairment model with a methodology that reflects expected credit losses and requires consideration of a broader range of reasonable and supportable information to inform credit loss estimates. The Company adopted this standard on January 1, 2022. There was no impact from the adoption of this standard on the Company's financial statements.

There are no other new accounting pronouncements that are expected to have a material impact on the Company's financial statements.

Nauticus Robotics, Inc.
Notes to Financial Statements
For the Years Ended December 31, 2021 and 2020

3. Property and Equipment

Property and equipment consisted of the following:

	Useful Life (years)	December 31,	
		2021	2020
Leasehold improvements	5.1	\$ 789,839	\$ 782,927
Property & equipment	5	1,216,609	622,872
Work-in-progress	5	150,220	—
Technology	5	773,535	601,917
Total		2,930,203	2,007,716
Less accumulated depreciation		(1,492,892)	(1,127,795)
Total property and equipment, net		\$ 1,437,311	\$ 879,921

4. Notes Payable

Notes payable consisted of the following:

	December 31,	
	2021	2020
Common stock repurchase note	\$ —	\$ 484,836
Schlumberger Technology Corp. contingently convertible promissory note	1,500,000	1,500,000
Transocean Inc. contingently convertible promissory note	1,500,000	1,500,000
Goradia Capital LLC contingently convertible promissory note	5,000,000	—
Material Impact Fund II, LP contingently convertible promissory note	5,000,000	—
In-Q-Tel, Inc. contingently convertible promissory note	250,000	—
RCB Equities #1, LLC term loan credit agreement	14,708,333	—
Total	27,958,333	3,484,836
Less: current portion, unrelated parties	(10,250,000)	(484,836)
current portion, related parties	(3,000,000)	(3,000,000)
Total Notes payable – long-term	\$ 14,708,333	\$ —

Common Stock Repurchase Note— On August 27, 2019, the Company entered into an unsecured Stock Repurchase Agreement with its former CEO under which the Company repurchased 271,600 common shares for a purchase price of \$944,927. The note bore interest at a fixed rate of 5% and was paid out over 24 months.

Schlumberger Technology Corp. Contingently Convertible Promissory Note— In July 2020, the Company issued an unsecured convertible promissory note to Schlumberger Technology Corp. (“Schlumberger”), a related party. There were two advances of \$750,000 each under the note made by Schlumberger upon achievement of key project development milestones. The Company received both advances in 2020.

The convertible promissory note bears interest at 4.25% and, as amended, matures on the earliest to occur of the following dates: (1) the issuance of a new series of preferred stock, (2) upon the occurrence of an event of default, or (3) December 31, 2022. In the event that an issuance by the Company of a new series of preferred stock occurs before an event of default or December 31, 2022, outstanding principal and unpaid accrued interest shall be converted into the new series of preferred stock at a conversion price of 90% of the issuance price per share of such new series.

An amendment to the promissory note executed on December 16, 2021 added another conversion option that in the event of the consummation of the merger between Nauticus and CleanTech occurring earlier than the other conversion options listed above, allows Schlumberger to convert the outstanding principal and unpaid accrued interest into Nauticus common shares at a conversion price of \$35.52 per share.

Transocean Inc. Contingently Convertible Promissory Note— In December 2020, the Company issued an unsecured convertible promissory note to Transocean Inc. (“Transocean”), a related party. There was one advance of \$1,000,000 and another of \$500,000 under the note made by Transocean upon achievement of key project development milestones. The Company received both advances in 2020.

Nauticus Robotics, Inc.
Notes to Financial Statements
For the Years Ended December 31, 2021 and 2020

4. Notes Payable (cont.)

The convertible promissory note bears interest at 10% and, as amended, matures on the earliest to occur of the following dates: (1) the issuance of a new series of preferred stock, (2) upon the occurrence of an event of default, or (3) December 31, 2022. In the event that an issuance by the Company of a new series of preferred stock occurs prior to the earlier of an event of default or December 31, 2022, outstanding principal balance and unpaid accrued interest shall be converted into the new series of preferred stock at a conversion price of 90% of the issuance price per share of such new series.

An amendment to the promissory note executed on December 16, 2021 added another conversion option that in the event of the consummation of the merger between Nauticus and CleanTech occurring earlier than the other conversion options listed above, allows Transocean to convert the outstanding principal and unpaid accrued interest into Nauticus common shares at a conversion price of \$35.52 per share.

Goradia Capital, LLC Contingently Convertible Promissory Note— On June 19, 2021, the Company issued an unsecured convertible promissory note to Goradia Capital, LLC (“Goradia”) in the amount of \$5,000,000. The amount was funded upon execution of the agreement.

The convertible promissory note bears interest at 10% and, as amended, matures on the earliest to occur of the following dates: (1) the issuance of a new series of preferred stock, (2) upon the occurrence of a change of control, or (3) December 31, 2022. In the event that an issuance by the Company of a new series of preferred stock occurs before a change of control or December 31, 2022, outstanding principal and unpaid accrued interest shall be converted into the new series of preferred stock at a conversion price of the lower of: (1) 90% of the issuance price per share of such new series and (2) the price per share equal to an amount obtained by dividing (x) \$75,000,000 by (y) the fully diluted shares outstanding of the Company as of June 19, 2021, which equals \$37.01.

An amendment to the promissory note executed on December 16, 2021 added another conversion option that in the event of the consummation of the merger between Nauticus and CleanTech occurring earlier than the other conversion options listed above, allows Goradia to convert the outstanding principal and unpaid accrued interest on the promissory note into Nauticus common shares at a conversion price of \$35.52 per share.

Material Impact Fund II, L.P. Contingently Convertible Promissory Note — On August 3, 2021, the Company issued an unsecured convertible promissory note to Material Impact Fund II, L.P. (“MIF”) in the amount of \$5,000,000. The amount was funded upon execution of the agreement.

The convertible promissory note bears interest at 5% and matures on the earliest to occur of the following dates: (1) the issuance of a new series of preferred stock, (2) upon the occurrence of a change of control, or (3) December 31, 2022. In the event that an issuance by the Company of a new series of preferred stock occurs before a change of control or December 31, 2022, outstanding principal and unpaid accrued interest shall be converted into the new series of preferred stock at a conversion price of the lower of: (1) 90% of the issuance price per share of such new series and (2) the price per share equal to an amount obtained by dividing (x) \$75,000,000 by (y) the fully diluted shares outstanding of the Company as of August 3, 2021, which equals \$37.01.

An amendment to the promissory note executed on December 16, 2021 added another conversion option that in the event of the consummation of the merger between Nauticus and CleanTech occurring earlier than the other conversion options listed above, allows MIF to convert the outstanding principal and unpaid accrued interest into Nauticus common shares at a conversion price of \$35.52 per share.

In-Q-Tel, Inc. Contingently Convertible Promissory Note — On October 22, 2021, the Company issued an unsecured convertible promissory note to In-Q-Tel, Inc. (“IQT”) in the amount of \$250,000. The amount was funded upon execution of the agreement.

The convertible promissory note bears interest at 5% and matures on the earliest to occur of the following dates: (1) the issuance of a new series of preferred stock with gross proceeds to the Company of at least \$10,000,000, (2) upon the occurrence of a change of control, or (3) December 31, 2022. In the event that an issuance by the

Nauticus Robotics, Inc.
Notes to Financial Statements
For the Years Ended December 31, 2021 and 2020

4. Notes Payable (cont.)

Company of a new series of preferred stock occurs before a change of control or December 31, 2022, outstanding principal and unpaid accrued interest shall be converted into the new series of preferred stock at a conversion price of the lower of: (1) 90% of the issuance price per share of such new series and (2) the price per share equal to an amount obtained by dividing (x) \$75,000,000 by (y) the fully diluted shares outstanding of the Company as of August 3, 2021, which equals \$37.01.

An amendment to the promissory note executed on December 16, 2021 added another conversion option that in the event of the consummation of the merger between Nauticus and CleanTech occurring earlier than the other conversion options listed above, allows IQT to convert the outstanding principal and unpaid accrued interest into Nauticus common shares at a conversion price of \$35.52 per share.

RCB Equities #1, LLC Term Loan Credit Agreement— On December 16, 2021, the Company entered into a Term Loan Credit Agreement with RCB Equities #1, LLC (“RCB”) in the amount of \$15,000,000 to provide funds for the Company’s working capital and general corporate purposes. The note bears interest at 13% per annum and is payable in 18 monthly installments of interest only through its maturity date of June 16, 2023. A 2% commitment fee totaling \$300,000 was paid upon loan inception and is presented as a debt discount. There is also a 5% exit fee totaling \$750,000 is payable at the maturity date and is being accrued over the note term. If the merger with CleanTech occurs prior to the maturity date, then within three days of the consummation of the merger, the note is due in full including all accrued and unpaid interest and fees. The outstanding principal balance of the note was \$14,708,333 at December 31, 2021 and its effective interest rate is approximately 17.7%.

Accounting Extinguishments of Debt — The December 16, 2021 modifications of the five contingently convertible notes discussed above were treated as extinguishments of debt for accounting purposes because the conversion options were considered substantive. A loss on the extinguishment of debt totaling \$9,484,113 was recognized for the difference between the carrying amounts of the notes and their fair values as of the modification date. Because the fair values of the notes included a substantial premium above their face values and the contingently convertible options did not require bifurcation, the premium was recorded to additional paid-in capital.

The fair values of the contingently convertible notes were determined by an independent valuation specialist whose model considered the stated terms of the notes, the Company’s effective borrowing rate for debt having similar terms and valuation of each of the convertible options. The conversion options were valued using the Black-Scholes option pricing model with the following inputs:

Expected volatility		55.4%
Expected term (years)		1.04
Risk-free interest rate		0.38%
Dividend yield		0.0%
Publicly traded price of CleanTech common stock	\$	10.00
Estimated fair value of Nauticus common stock	\$	35.52

Since there is no public market for the Company’s common stock, the expected volatility was determined based on a peer group of publicly traded companies. In evaluating similarity of this peer group, the Company considered factors such as stage of development, risk profile, enterprise value and position within the industry. The risk-free rate was based on the U.S. Treasury yield curve in effect at the modification date for the time until maturity of the notes. The Company assumed the expected dividends to be zero as it has never paid dividends and at the modification date had no plans to do so. We used the publicly traded price of Cleantech’s common stock at the modification date in valuing the conversion option in the event the merger is consummated. In valuing the conversion option should additional financing be completed, we used the estimated fair value of Nauticus’ common stock.

The Company referenced its recent term loan borrowing with RCB to estimate its effective borrowing rate for debt having similar terms. The effective rate used was 17.7%.

Nauticus Robotics, Inc.
Notes to Financial Statements
For the Years Ended December 31, 2021 and 2020

4. Notes Payable (cont.)

The fair values of each component of the contingently convertible notes were probabilistically weighted to determine the overall fair value of each note. This probability weighting considered the likelihood that the planned merger of Nauticus and Cleantech will be completed, the probability of additional financing as well as the probability of a cash repayment of the notes at maturity if the conversion options are not exercised.

5. SBA Paycheck Protection Program Loan

On April 17, 2020, the Company received proceeds from a Small Business Administration (“SBA”) Paycheck Protection Program (“PPP”) Loan in the amount of \$1,578,500 from Frost Bank, as lender, pursuant to the *Coronavirus Aid, Relief, and Economic Security Act*. The purpose of the PPP was to encourage the continued employment of workers. On February 5, 2021, the Company received proceeds from a second PPP Loan in the amount of \$1,578,500 from Frost Bank, as lender. Both PPP Loans had an interest rate of 1% per annum and a five-year maturity. Under the terms of the PPP Loans, all or a portion of the principal and accrued interest thereon was forgivable by the SBA.

The Company accounted for the PPP Loans as in-substance government grants because it expected to meet the PPP Loans eligibility criteria and concluded that the loans represented, in substance, grants that were expected to be forgiven. Proceeds from the PPP Loans were initially recognized as a deferred income liability.

During the period from loan funding through December 31, 2020, the Company used the first PPP Loan proceeds for eligible payroll expenses, lease, and interest payments. Accordingly, we recognized \$1,578,500 as other income in the statements of operations for the year ended December 31, 2020. In 2021, the Company used the proceeds from the second PPP loan for eligible payroll expenses, lease, and interest payments. Accordingly, we recognized \$1,578,500 as other income in the statements of operations for the year ended December 31, 2021.

The Company’s application for forgiveness of the first PPP Loan’s principal and accrued interest was approved in full by the SBA on May 20, 2021 and the second PPP Loan’s principal and accrued interest was approved in full by the SBA on August 16, 2021.

6. Leases

The Company leases its office and manufacturing facility under a 64-month operating lease expiring April 30, 2024. The lease includes rent escalations and chargebacks to the Company for build-out costs. The right-of-use asset and lease liability amounts were determined using an 8% discount rate which was the interest rate related to the leasehold improvement obligation.

The operating lease includes a leasehold improvement obligation of \$190,650 which bears interest at 8% and matures on April 30, 2024. The balance of this obligation was \$96,375 and \$133,070 as of December 31, 2021 and 2020, respectively, and is included in operating lease liabilities in the balance sheets.

Total operating lease expense, which is accounted for in cost of revenue, was as follows:

	Years ended December 31,	
	2021	2020
Fixed lease expense	\$ 275,485	\$ 348,703
Variable lease expense	180,818	192,505
Total	<u>\$ 456,303</u>	<u>\$ 541,208</u>

Nauticus Robotics, Inc.
Notes to Financial Statements
For the Years Ended December 31, 2021 and 2020

6. Leases (cont.)

Future minimum lease payments as of December 31, 2021 were as follows:

2022	\$ 363,551
2023	357,968
2024	120,912
Total lease payments	842,431
Less imputed interest	(21,625)
Total	<u>\$ 820,806</u>

7. Commitments and Contingencies

Litigation — From time to time, the Company may be subject to litigation and other claims in the normal course of business. No amounts have been accrued in the financial statements with respect to any matters.

8. Income Taxes

No amounts were recorded for income tax expense during the years ended December 31, 2021 or 2020. A reconciliation of the expected statutory federal tax and the total income tax expense was as follows:

	Year Ended December 31,	
	2021	2020
Federal statutory rate	\$ (3,176,802)	\$ (1,510,748)
State income taxes, net	—	—
Change in valuation allowance	3,783,112	2,218,615
PPP Loans forgiveness	(331,485)	(331,485)
Research & development tax credit	(282,774)	(379,073)
Other, net	7,949	2,691
Total income tax expense	<u>\$ —</u>	<u>\$ —</u>

The tax effect of temporary differences that gave rise to significant components of deferred tax assets and liabilities consisted of the following:

	December 31,	
	2021	2020
Deferred tax assets:		
Net operating loss carryforwards	\$ 6,645,145	\$ 5,261,805
R&D tax credit carryforward	1,616,415	1,333,641
Charitable contributions carryover	20,469	25,568
Contract liabilities	61,696	—
Convertible notes	1,991,664	—
Stock-based compensation	318,322	228,333
Total deferred tax assets	10,653,711	6,849,347
Deferred tax liabilities:		
Contract assets	(18,769)	—
Depreciation	(17,347)	(14,864)
Net deferred tax asset before valuation allowance	10,617,595	6,834,483
Valuation allowance	(10,617,595)	(6,834,483)
Net deferred tax asset	<u>\$ —</u>	<u>\$ —</u>

Nauticus Robotics, Inc.
Notes to Financial Statements
For the Years Ended December 31, 2021 and 2020

8. Income Taxes (cont.)

The Company has federal net operating loss carryforwards of approximately \$31.6 million at December 31, 2021, of which about \$646,000 begin to expire in 2035 and the remainder have no expiration. The Company has recorded a full valuation allowance against its net deferred tax assets due to recurring net losses.

9. Equity

Common Stock — A total of 680,600 shares of common stock remain outstanding at December 31, 2021.

Series A Preferred Stock — The Company has 334,800 shares of Series A Preferred Stock outstanding. Each share of the Series A Preferred Stock may be converted at the holder's option into common stock of the Company at a conversion price of \$8.96 for each share of Series A Preferred Stock. The Series A Preferred Stock possesses full voting rights, on an as-converted basis, with the common stock of the Company, and has no stated dividend rate. Holders of Series A Preferred Stock are entitled to dividends at the same rate payable on the Company's common stock should a common stock dividend be declared. The Series A Preferred Stock has priority rights in a liquidation, wind-up, sale, or merger of the Company.

Series B Preferred Stock — The Company has 725,426 shares of Series B Preferred Stock outstanding. Each share of the Series B Preferred Stock may be converted at the holder's option into common stock of the Company at a conversion price of \$27.57 for each share of Series B Preferred Stock. The Series B Preferred Stock possesses full voting rights, on an as-converted basis, with the common stock of the Company, and has no stated dividend rate. Holders of Series B Preferred Stock are entitled to dividends at the same rate payable on the Company's common stock should a common stock dividend be declared. The Series B Preferred Stock has priority rights in a liquidation, wind-up, sale, or merger of the Company.

Common Stock Repurchase Agreements — The Company entered into agreements with its stockholders and option holders for the repurchase at the Company's option of up to 950,000 shares of outstanding common stock at prices based upon agreed valuation formulas. The Company is not obligated to make such repurchases but may exercise its rights under these agreements at any time on or after the separation or retirement of the stockholder from employment at the Company. Repurchased shares are held as treasury shares at their cost. The payment for repurchased shares is, at the Company's option, either (a) made in full at the time of repurchase, or (b) made over a 24-month period.

Stock-Based Compensation — The Company has a stock-based compensation plan under which stock options may be granted as incentive compensation. At December 31, 2021, no shares were available under the current plan for future award.

Options vest assuming continuous service to the Company with 25% of the options vesting one year after grant and the balance vesting in a series of 36 successive equal monthly installments measured from the first anniversary of grant. During the vesting period, the participants have voting rights, but the options may not be sold, assigned, transferred, pledged, or otherwise encumbered. Unvested shares are forfeited upon termination of employment and vested shares may be repurchased by the Company at its option.

Compensation expense for stock option grants is recognized based on the fair value at the date of grant using the Black-Scholes option pricing model.

Nauticus Robotics, Inc.
Notes to Financial Statements
For the Years Ended December 31, 2021 and 2020

9. Equity (cont.)

The following inputs were used to calculate the fair value of the options as of the date of each grant:

	Years ended December 31,	
	2021	2020
Expected volatility	52.7%	50.0%
Expected term (years)	6.25	6.25
Risk-free interest rate	1.3%	1.1%
Expected dividends	0.0%	0.0%

Since there is no public market for the Company's common stock, the expected volatility for options was determined based on a peer group of publicly traded companies. In evaluating similarity of this peer group, the Company considered factors such as stage of development, risk profile, enterprise value and position within the industry. The Company used the "simplified method" for estimating the expected term of options, which is the average of the weighted-average vesting period and contractual term of the option. The risk-free rate was based on the U.S. Treasury yield curve in effect at the time of grant for the expected term of the stock options. The Company assumed the expected dividends to be zero as it has never paid dividends and at the grant date of the options had no plans to do so.

Stock-based compensation expense totaled \$425,580 in 2021 and \$417,303 in 2020 and was booked in general and administrative expense. As of December 31, 2021, there was \$1,995,104 of total unrecognized compensation cost related to options to be recognized over a remaining weighted average period of 25.8 months.

The following table summarizes options outstanding, as well as activity for the periods presented:

	Shares	Weighted Average Grant Date Fair Value	Weighted Average Exercise Price	Aggregate Intrinsic Value
Outstanding as of December 31, 2019	152,450	\$ 10.27	\$ 22.07	\$ 835,974
Granted	29,600	\$ 11.55	\$ 23.78	
Forfeited	(3,200)	\$ 13.26	\$ 27.57	
Cancelled	(13,750)	\$ 4.80	\$ 17.68	
Outstanding as of December 31, 2020	165,100	\$ 10.90	\$ 22.63	\$ 779,457
Granted	121,398	\$ 15.63	\$ 27.57	
Exercised	(2,200)	\$ 6.66	\$ 16.00	
Cancelled	(6,450)	\$ 11.09	\$ 26.67	
Outstanding as of December 31, 2021	277,848	\$ 12.99	\$ 24.75	\$ 2,992,895

The total intrinsic value of all options exercised during the years ended December 31, 2021 and 2020 was \$42,944 and \$0, respectively. The intrinsic value of all options outstanding at December 31, 2021 and 2020 was \$2,992,895 and \$779,457, respectively. The intrinsic value of all exercisable options at December 31, 2021 and 2020 was \$1,678,662 and \$369,699, respectively.

Proceeds from option exercises under the stock option plan for the years ended December 31, 2021 and December 31, 2020 were \$35,200 and \$0, respectively. The tax benefit realized from stock-based compensation was \$16,410 and \$0 for the years ended December 31, 2021 and December 31, 2020, respectively. Realization of this amount is dependent on the generation of future taxable income.

Nauticus Robotics, Inc.
Notes to Financial Statements
For the Years Ended December 31, 2021 and 2020

9. Equity (cont.)

The following tabulation summarizes certain information related to outstanding and exercisable options at December 31, 2021:

Range of Exercisable Prices	Options Outstanding			Options Exercisable		
	As of December 31, 2021	Weighted Average Remaining Contractual Life In Years	Weighted Average Exercise Price	As of December 31, 2021	Weighted Average Exercise Price	
\$ 8.96 – \$ 16.00	43,750	4.64	\$ 12.21	43,750	\$ 12.21	
20.81 – 27.57	234,098	8.55	27.09	78,196	27.09	
\$ 8.96 – \$ 27.57	277,848	7.93	\$ 24.75	121,946	\$ 23.19	

The remaining weighted average contractual life of exercisable options at December 31, 2021 was 6.1 years.

10. Employee Benefit Plan

Nauticus offers a 401(k) plan which permits eligible employees to contribute portions of their compensation to an investment trust. The Company makes contributions to the plan totaling 3% of employees' gross salaries and such contributions vest immediately. The 401(k) plan provides several investment options, for which the employee has sole investment discretion. The Company's cost for the 401(k) plan was \$210,945 and \$218,635 at December 31, 2021 and 2020, respectively.

11. Related Party Transactions

Contingently Convertible Promissory Notes — In 2020, Nauticus issued convertible promissory notes to Schlumberger and Transocean, each with an amount of \$1,500,000. These notes were modified in December 2021. As of December 31, 2021, Schlumberger N.V. owned 29.7% and Transocean Ltd. owned 31.3% of the voting stock of Nauticus. See Note 4 for more information about the contingently convertible notes.

Revenue and Accounts Receivable — Revenue from Transocean Ltd. for contract services and products totaled \$494,835 and \$809,811 in 2021 and 2020, respectively. Accounts receivable included \$39,225 and \$62,773 outstanding from Transocean Ltd. at December 31, 2021 and 2020, respectively.

12. Earnings (Loss) Per Share

The following table is a calculation of the earnings (loss) per basic and diluted share:

	December 31,	
	2021	2020
Numerator		
Net loss	\$ (15,127,629)	\$ (7,194,038)
Denominator		
Weighted average shares used to compute basic EPS	678,406	678,400
Dilutive effect of stock-based awards	—	—
Weighted average shares used to compute diluted EPS	678,406	678,400
Loss per share		
Basic	\$ (22.30)	\$ (10.60)
Diluted	\$ (22.30)	\$ (10.60)

Nauticus Robotics, Inc.
Notes to Financial Statements
For the Years Ended December 31, 2021 and 2020

12. Earnings (Loss) Per Share (cont.)

Diluted earnings (loss) per share for 2021 and 2020 excludes 277,848 and 165,100 options to purchase common shares, respectively, along with the shares related to the contingently convertible debt, because their effect would be anti-dilutive.

13. Subsequent Events

In preparing the financial statements, the Company has evaluated all subsequent events and transactions for potential recognition or disclosure through April 27, 2022, the date the financial statements were available for issuance.

Form S-4 Registration Filing— On January 31, 2022, CleanTech announced that it has filed a registration statement on Form S-4 with the U.S. Securities and Exchange Commission. The filing includes a preliminary proxy statement/prospectus in connection with Nauticus' proposed business combination with CleanTech. The transaction, which has been approved by the Nauticus Board of Directors and the CleanTech Board of Directors, is expected to close in May 2022. The transaction remains subject to approval by Nauticus and CleanTech shareholders and other customary closing conditions (including receipt of required regulatory approvals).

Diverse Marine Ltd. Construction Agreement— On February 14, 2022, Nauticus signed an agreement with Diverse Marine Ltd. ("Diverse Marine") by which Diverse Marine will construct two marine vessels for Nauticus, the Hydronaut 2 and the Hydronaut 3. The purchase price for the Hydronaut 2 is \$4.3 million and Nauticus is expected to take delivery in February, 2023. The purchase price for the Hydronaut 3 is \$4.2 million and Nauticus is expected to take delivery in March, 2023. Both agreements require payment in Great British Pounds as certain milestones are met over the duration of the construction period.

Kongsberg Maritime AS Agreement— During March 2022, Nauticus signed an agreement with Kongsberg Maritime AS ("Kongsberg") by which Kongsberg will design and construct two Launch and Recovery Systems (LARS) for the Nauticus' Aquanaut, each to be fitted to two Hydronauts built by Diverse Marine. The two LARS are referred to in the Diverse Marine Ltd. Construction Agreement as "Free Issue" equipment that Nauticus is required to provide to Diverse Marine as part of the Hydronaut construction process. The purchase price for the LARS 1 is \$1.1 million and Nauticus is expected to take delivery in January, 2023. The purchase price for the LARS 2 is \$0.8 million and Nauticus is expected to take delivery in January, 2023. Both agreements require payment in NOK. A copy of the agreement is included here as Exhibit 10.30.

iXBlue, Inc Agreement — During 2022, Nauticus signed an agreement with iXBlue, Inc. ("iXBlue") by which iXBlue will construct a Drix USV for Nauticus. The purchase price for the Drix USV is \$1.7 million and Nauticus is expected to take delivery in September, 2023.

Capital Markets advisory services related to Cleantech Acquisition — In order to broaden Nauticus' reach to additional potential investors, parties have entered into a few letter agreements with investment banks for their capital markets advisory services.

Pursuant to a letter agreement dated February 28, 2022 with Lake Street Capital Markets ("Lake Street"), Nauticus has agreed to pay Lake Street a non-refundable retainer of \$350,000 within ten days following the closing of the Business Combination for Lake Street's capital markets advisory services which include, among other things, (i) providing advice and assistance to CLAQ in evaluating its capital raising strategies and alternatives; (ii) assisting CLAQ in refining and communicating its investor presentation; and (iii) working and coordinating with CLAQ's investors relations resources to conduct a non-deal investor roadshow in the U.S. and solicit, and analyze investors' feedback.

Pursuant to a letter agreement dated March 23, 2022 with Cowen and Company, LLC ("Cowen"), Nauticus has agreed to pay Cowen an advisory fee of \$1,750,000 (the "Business Combination Fee") upon closing of the Business Combination for its capital market advisory services which include, among other things, (i) familiarizing itself with the business, properties and operation of each of CLAQ and Nauticus; (ii) advising Nauticus on investor outreach,

Nauticus Robotics, Inc.
Notes to Financial Statements
For the Years Ended December 31, 2021 and 2020

13. Subsequent Events (cont.)

assisting Nauticus in scheduling and arranging meetings with current and potential holders of its securities; and (iii) assisting Nauticus in formulating a marketing strategy for the Business Combination. If this agreement with Cowen is terminated, the Business Combination Fee will still be payable if a business combination is consummated within twelve months from the date of the termination of the agreement (the "Residual Period"). If during the term of this agreement with Cowen or the Residual Period, Nauticus proposes to affect any restructuring, acquisition or disposition, or certain sales of securities, Nauticus has agreed to engage Cowen and offer Cowen no less than 35% of the total economics for any such capital raising transaction.

Pursuant to an amended and restated letter agreement dated April 25, 2022 with Coastal Equities, Inc. ("Coastal"), Nauticus has agreed to pay Coastal a cash fee of \$7,600,000 ("Cash Fee") upon closing of the Business Combination or any other transaction defined as a "Sale" of Nauticus pursuant to the letter agreement in return for Coastal's financial advisory services which include, among other things, (i) facilitating potential purchasers' or financing participants' due diligence investigation; (ii) performing valuation analyses; (iii) identifying opportunities for the Sale of Nauticus; and (iv) as requested by Nauticus, participating on Nauticus' behalf in negotiations concerning such Sale. If this letter agreement with Coastal is terminated, the Cash Fee will still be payable if the Sale of Nauticus occurs within 9 months from March 29, 2022, the effective date of the letter agreement.

* * * * *



Houston Office
3737 Buffalo Speedway
Suite 1600
Houston, Texas 77098
713.621.1515 Main

whitleypenn.com

REPORT OF INDEPENDENT REGISTERED PUBLIC ACCOUNTING FIRM

Board of Directors and Stockholders
Nauticus Robotics, Inc.

Results of Review of Interim Financial Statements

We have reviewed the condensed balance sheet of Nauticus Robotics, Inc. as of March 31, 2022, the related condensed statements of operations, changes in stockholders' equity (deficit), and cash flows for the three-month periods ended March 31, 2022 and 2021, and the related notes to condensed financial statements (collectively referred to as the "condensed financial statements"). Based on our review, we are not aware of any material modifications that should be made to the condensed financial statements for them to be in conformity with accounting principles generally accepted in the United States of America.

We have previously audited, in accordance with the standards of the Public Company Accounting Oversight Board (United States) ("PCAOB"), the balance sheet of Nauticus Robotics, Inc. as of December 31, 2021, and the related statements of operations, stockholders' equity (deficit), and cash flows for the year then ended (not presented herein); and in our report dated March 24, 2022, we expressed an unmodified opinion on those financial statements. In our opinion, the information set forth in the accompanying condensed balance sheet as of March 31, 2022, is fairly stated, in all material respects, in relation to the balance sheet from which it has been derived.

Basis for Review Results

These condensed financial statements are the responsibility of the entity's management. We conducted our review in accordance with the standards of the PCAOB. We are a public accounting firm registered with the PCAOB and are required to be independent with respect to the company in accordance with the U.S. federal securities laws and the applicable rules and regulations of the Securities and Exchange Commission and the PCAOB.

A review of interim financial information consists principally of applying analytical procedures and making inquiries of persons responsible for financial and accounting matters. It is substantially less in scope than an audit conducted in accordance with the standards of the PCAOB, the objective of which is the expression of an opinion regarding the financial statements taken as a whole. Accordingly, we do not express such an opinion.

/s/ Whitley Penn LLP
Houston, Texas
May 16, 2022



NAUTICUS ROBOTICS, INC.
CONDENSED BALANCE SHEETS
(UNAUDITED)

	March 31, 2022	December 31, 2021
Assets		
Current Assets		
Cash and cash equivalents	\$ 15,077,379	\$ 20,952,867
Restricted certificate of deposit	251,236	251,236
Accounts receivable, net of allowance	1,005,915	794,136
Inventory	721,042	—
Contract assets	592,759	893,375
Other current assets	729,880	277,444
Total Current Assets	<u>18,378,211</u>	<u>23,169,058</u>
Property and equipment, net	3,001,230	1,437,311
Right-of-use asset – operating lease	481,438	513,763
Other assets	172,705	47,240
Total Assets	<u>\$ 22,033,584</u>	<u>\$ 25,167,372</u>
Liabilities and Stockholders' Equity (Deficit)		
Current Liabilities		
Accounts payable	\$ 1,657,452	\$ 1,400,514
Accrued payroll	451,488	411,008
Accrued interest	857,596	703,544
Other accrued liabilities	74,942	90,000
Contract liabilities	—	373,791
Operating lease liabilities – current	399,274	353,598
Notes payable – current	10,250,000	10,250,000
Notes payable, related parties – current	3,000,000	3,000,000
Total Current Liabilities	<u>16,690,752</u>	<u>16,582,455</u>
Operating lease liabilities – long-term	356,989	467,208
Notes payable – long-term	14,757,896	14,708,333
Other liabilities	143,249	20,833
Total Liabilities	<u>31,948,886</u>	<u>31,778,829</u>
Commitments and Contingencies		
Stockholders' Equity (Deficit)		
Series A preferred stock, \$0.01 par value; 334,800 shares authorized, issued, and outstanding	3,348	3,348
Series B preferred stock, \$0.01 par value; 725,426 shares authorized, issued, and outstanding	7,254	7,254
Common stock, \$0.01 par value; 10,000,000 shares authorized, 952,200 and 950,000 shares issued, respectively, and 680,600 and 678,400 shares outstanding, respectively	9,522	9,522
Treasury stock, at cost; 271,600 shares	(944,927)	(944,927)
Additional paid-in capital	34,358,034	34,157,877
Accumulated deficit	(43,348,533)	(39,844,531)
Total Stockholders' Equity (Deficit)	<u>(9,915,302)</u>	<u>(6,611,457)</u>
Total Liabilities and Stockholders' Equity (Deficit)	<u>\$ 22,033,584</u>	<u>\$ 25,167,372</u>

The accompanying notes are an integral part of these condensed financial statements.

NAUTICUS ROBOTICS, INC.
CONDENSED STATEMENTS OF OPERATIONS
(UNAUDITED)

	Three months ended March 31,	
	2022	2021
Revenue		
Service	\$ 2,235,965	\$ 161,478
Service – related party	—	141,265
Total revenue	2,235,965	302,743
Costs and Expenses		
Cost of revenue (exclusive of items shown separately below)	1,899,161	698,888
Depreciation and amortization	111,319	87,716
Research and development	1,267,412	1,202,718
General and administrative	1,646,041	659,706
Total costs and expenses	4,923,933	2,649,028
Operating loss	(2,687,968)	(2,346,285)
Other expense (income)		
Other (income) expense, net	14,060	(888,153)
Interest expense, net	801,974	61,550
Total other (income) expense, net	816,034	(826,603)
Net loss	<u>\$ (3,504,002)</u>	<u>\$ (1,519,682)</u>
Earnings (loss) per common share		
Basic	\$ (5.15)	\$ (2.24)
Diluted	\$ (5.15)	\$ (2.24)
Basic weighted average shares outstanding		
	680,600	678,400
Diluted weighted average shares outstanding		
	680,600	678,400

The accompanying notes are an integral part of these condensed financial statements.

NAUTICUS ROBOTICS, INC.
CONDENSED STATEMENTS OF CHANGES OF STOCKHOLDERS' EQUITY (DEFICIT)
(UNAUDITED)

	Series A Preferred Stock		Series B Preferred Stock		Common Stock		Treasury Stock	Additional Paid-in Capital	Accumulated Deficit	Total Stockholders' Equity (Deficit)
	Shares	Amount	Shares	Amount	Shares	Amount				
Balance at January 1, 2021	334,800	\$ 3,348	725,426	\$ 7,254	950,000	\$ 9,500	\$(944,927)	\$ 24,213,006	\$(24,716,902)	\$(1,428,721)
Stock-based compensation	—	—	—	—	—	—	—	107,794	—	107,794
Net loss	—	—	—	—	—	—	—	—	(1,519,682)	(1,519,682)
Balance at March 31, 2021	<u>334,800</u>	<u>\$ 3,348</u>	<u>725,426</u>	<u>\$ 7,254</u>	<u>950,000</u>	<u>\$ 9,500</u>	<u>\$(944,927)</u>	<u>\$ 24,320,800</u>	<u>\$(26,236,584)</u>	<u>\$(2,840,609)</u>
Balance at January 1, 2022	334,800	\$ 3,348	725,426	\$ 7,254	952,200	\$ 9,522	\$(944,927)	\$ 34,157,877	\$(39,844,531)	\$(6,611,457)
Stock-based compensation	—	—	—	—	—	—	—	200,157	—	200,157
Net loss	—	—	—	—	—	—	—	—	(3,504,002)	(3,504,002)
Balance at March 31, 2022	<u>334,800</u>	<u>\$ 3,348</u>	<u>725,426</u>	<u>\$ 7,254</u>	<u>952,200</u>	<u>\$ 9,522</u>	<u>\$(944,927)</u>	<u>\$ 34,358,034</u>	<u>\$(43,348,533)</u>	<u>\$(9,915,302)</u>

The accompanying notes are an integral part of these condensed financial statements.

NAUTICUS ROBOTICS, INC.
CONDENSED STATEMENTS OF CASH FLOWS
(UNAUDITED)

	Three months ended March 31,	
	2022	2021
Cash Flows From Operating Activities		
Net loss	\$ (3,504,002)	\$ (1,519,682)
Adjustments to reconcile net loss to net cash from operating activities:		
Depreciation and amortization	111,319	87,716
Stock-based compensation	200,157	107,794
Amortization of debt discount	171,979	—
Noncash impact of lease accounting	32,325	30,144
Other income – PPP Loan	—	(891,850)
Changes in operating assets and liabilities:		
Accounts receivable	(211,779)	39,908
Inventory	(721,042)	—
Contract assets	300,616	(79,379)
Other assets	(577,901)	(43,616)
Accounts payable and accrued liabilities	436,412	174,818
Contract liabilities	(373,791)	(161,478)
Operating lease liabilities	(64,543)	(59,332)
Net cash from operating activities	<u>(4,200,250)</u>	<u>(2,314,957)</u>
Cash Flows From Investing Activities		
Additions to property and equipment	(1,675,238)	—
Net cash from investing activities	<u>(1,675,238)</u>	<u>—</u>
Cash Flows From Financing Activities		
Proceeds from PPP Loan	—	1,578,500
Payments of note payable	—	(118,839)
Net cash from financing activities	<u>—</u>	<u>1,459,661</u>
Net change in cash and cash equivalents	(5,875,488)	(855,296)
Cash and Cash Equivalents, beginning of period	20,952,867	3,298,180
Cash and Cash Equivalents, end of period	<u>\$ 15,077,379</u>	<u>\$ 2,442,884</u>
Supplemental cash flow information		
Cash paid for interest	<u>\$ 428,595</u>	<u>\$ 9,032</u>
Cash paid for taxes	<u>\$ —</u>	<u>\$ —</u>

The accompanying notes are an integral part of these condensed financial statements.

NAUTICUS ROBOTICS, INC.
NOTES TO CONDENSED FINANCIAL STATEMENTS
(UNAUDITED)

1. Description of the Business

Nauticus Robotics, Inc. (“Nauticus”, “Company”, “our”, or “we”) was initially incorporated as Houston Mechatronics, Inc. on March 27, 2014 in the State of Texas. Effective November 24, 2021, the Company changed its legal name to Nauticus Robotics, Inc. Nauticus’ principal corporate offices are located in Webster, Texas. The Company is developing an ecosystem of ocean robots that are controlled through an AI-driven cloud software platform which enables a sliding scale spectrum of autonomous operations — from direct operator control to complete hands-off, robot self-sufficient control. Instead of the conventional tethered connection between the operator and the subsea robot, Nauticus has developed an acoustic communication networking, compression, and protocols that allows the robot to perform its tasks without a direct, cabled connection. This offering permits significant operational flexibility and cost savings over the methods currently deployed in the marketplace.

Impact of COVID-19 Pandemic on Business — The global spread of COVID-19 has created significant market volatility and economic uncertainty and disruption during 2021. The Company was adversely affected by the deterioration and increased uncertainty in the macroeconomic outlook as a result of the impact of COVID-19. We continue to actively monitor the situation and may take further actions altering our business operations that we determine are in the best interests of our employees, customers, suppliers, and stakeholders, or as required by federal, state, or local authorities.

Liquidity — The Company has had recurring losses and negative cash flows since inception. As such, the Company has been dependent on debt and equity funding to meet its development efforts. The Company continues to develop its principal products and conducts extensive research and development activities. At March 31, 2022, the Company had net working capital of \$1,687,459.

On October 15, 2021, the Company signed a purchase order with Triumph Subsea Construction Limited (customer) for the sale of four Aquanaut systems over a period from September 2022 through January 2025 for a total of \$54 million.

On December 16, 2021, Nauticus entered into a merger agreement with CleanTech Acquisition Corporation (“CleanTech”), a special purpose acquisition company (“SPAC”). In this agreement, Nauticus agreed to a business combination that is intended to lead to its public stock listing on the NASDAQ in May 2022. CleanTech brings approximately \$260 million in sponsored investment and public investment in private equity funding to the business combination. Although this level of funding is potentially available, a threshold of \$50 million has been established in the merger documents as the minimum cash position for internal planning purposes.

Management believes that with the revenue from its existing and new contracts, the ability to reduce costs as necessary, and the pending merger with CleanTech, the Company will have sufficient cash from operations to meet its obligations for at least one year from the issuance date of this report.

2. Summary of Significant Accounting Policies

Basis of Presentation — These interim condensed financial statements are unaudited. However, the condensed balance sheet as of December 31, 2021, contains financial information taken from the audited Nauticus financial statements as of that date. Certain disclosures have been condensed or omitted from these financial statements. Accordingly, they do not include all the information and notes required by accounting principles generally accepted in the United States of America (“GAAP”) for complete financial statements and should be read in conjunction with the audited December 31, 2021, financial statements and notes.

In the opinion of management, the accompanying unaudited condensed financial statements include all adjustments, consisting of normal recurring adjustments, necessary to fairly present the financial position as of, and the results of operations for, all periods presented. In preparing the accompanying financial statements, management has made certain estimates and assumptions that affect reported amounts in the condensed financial statements and disclosures of contingencies. Actual results may differ from those estimates. The results for interim periods are not necessarily indicative of annual results.

NAUTICUS ROBOTICS, INC.
NOTES TO CONDENSED FINANCIAL STATEMENTS
(UNAUDITED)

2. Summary of Significant Accounting Policies (cont.)

Use of Estimates — The preparation of financial statements in conformity with GAAP requires management to make estimates and assumptions that affect the reported amounts of assets and liabilities and disclosure of contingent assets and liabilities at the date of the financial statements and the reported amounts of revenues and expenses during the period. Significant items subject to such estimates and assumptions include the (i) estimates of future costs to complete customer contracts recognized over time, (ii) valuation allowances for deferred income tax assets, and (iii) valuation of stock-based compensation. Actual results could differ from those estimates.

Fair Value Measurements — The estimated fair values of accounts receivable, contract assets, accounts payable, accrued expenses, and indebtedness with unrelated parties approximate their carrying amounts due to the relatively short maturity or time to maturity of these instruments. Notes payable with related parties may not be arms-length transactions and therefore, may not reflect fair value.

The Company's non-financial assets measured at fair value on non-recurring basis include stock-based compensation awards. These are considered Level 3 measurements as they involve significant unobservable inputs.

Inventories — Inventories consist of raw materials and work in process used in the construction and installation of a portfolio of ocean robotics systems technology products that include the Aquanaut and Olympic Arm. Raw materials consist of composite marine structures, commercial off-the-shelf or (COTS), batteries, and hardware and electrical components. Work in progress inventory consists of raw materials and labor for construction of projects. Inventories are stated at the lower of cost or net realizable value. Cost is determined using the first-in, first-out method. The Company periodically reviews inventories for specifically identifiable items that are unusable or obsolete based on assumptions about future demand and market conditions. Based on this evaluation, the company will make provisions for unusable and obsolete inventories in order to write inventories down to their net realizable value.

Inventories consist of the following:

	March 31, 2022	December 31, 2021
Raw material and supplies	\$ 3,739	\$ —
Work in progress	717,303	—
Finished goods	—	—
Total inventories	<u>\$ 721,042</u>	<u>\$ —</u>

Revenue — The Company's primary sources of revenue are from providing technology and engineering services and products to the offshore industry and governmental entities. Revenue is generated pursuant to contractual arrangements to design and develop subsea robots and software and to provide related engineering, technical, and other services according to the specifications of the customers. These contracts can be service sales (cost plus fixed fee or firm fixed fee) or product sales and typically have terms of up to 18 months. The Company has limited product sales as its core products are still under development. Product sales to date have been for HaloGuard, a red zone monitoring solution we developed.

A performance obligation is a promise in a contract to transfer distinct goods or services to a customer. The products and services in our contracts are typically not distinct from one another. Accordingly, our contracts are typically accounted for as one performance obligation.

The Company's performance obligations under service agreements generally are satisfied over time as the service is provided. Revenue under these contracts is recognized over time using an input measure of progress (typically costs incurred to date relative to total estimated costs at completion). This requires management to make significant estimates and assumptions to estimate contract sales and costs associated with its contracts with customers. At the outset of a long-term contract, the Company identifies risks to the achievement of the technical, schedule and cost aspects of the contract. Throughout the contract term, on at least a quarterly basis, we monitor and assess the effects of those risks on its estimates of sales and total costs to complete the contract. Changes in these estimates could have a material effect on the Company's results of operations.

NAUTICUS ROBOTICS, INC.
NOTES TO CONDENSED FINANCIAL STATEMENTS
(UNAUDITED)

2. Summary of Significant Accounting Policies (cont.)

The components of revenue are as follows:

	Three months ended March 31,	
	2022	2021
Cost plus fixed fee	\$ 1,423,259	\$ 302,743
Firm fixed-price	434,373	—
Firm fixed-price-vehicle lease	378,333	—
Total	<u>\$ 2,235,965</u>	<u>\$ 302,743</u>

Firm-fixed price contracts present the risk of unreimbursed cost overruns, potentially resulting in lower-than-expected contract profits and margins. This risk is generally lower for cost plus fixed fee contracts which, as a result, generally have a lower margin.

In June 2021 Nauticus Robotics signed a Subcontractor Agreement with an unrelated third party to provide Engineering, Design, Development and Other Services which also includes a lease for an Aquanaut vehicle (“Vehicle Lease”). The Vehicle Lease is for a total of \$2,270,000, or \$126,111 per month for 18 months. Service revenue recognize for the three months ended March 31, 2022, was \$378,333 of equipment rental income on the contractual cash rental payments for the period. The Company comparably recorded no revenue for the three months ended March 31, 2021.

The lease is an operating lease as defined by ASC 842, and revenue will be recognized on a straightline basis over the remaining term of the lease as follows:

Minimum Future Rental Income Year ended December 31, 2022	Amount
2022 (remainder)	\$ 1,135,001
Thereafter	—
Total	<u>\$ 1,135,001</u>

Performance obligations for product sales typically are satisfied at a point in time. This occurs when control of the products is transferred to the customer, which generally is when title and risk of loss have passed to the customer.

Unfulfilled Performance Obligations

As of March 31, 2022, we expect to recognize approximately \$64 million of revenue in future periods from unfulfilled performance obligations from existing contracts with customers including \$54 million that relates to the Triumph Subsea Construction Purchase Order as described in Note 1. We expect to recognize revenue of approximately \$20.6 million from our remaining performance obligations over the next 12 months with the remaining balance recognized thereafter. If any of our contracts were to be modified or terminated, the expected value of the unfilled performance obligations of such contracts would be reduced.

Accounts receivables, net, at March 31, 2022 totaled \$1,005,915 due from customers for contract billings and is expected to be collected within the next three to six months. At December 31, 2021, accounts receivable, net, totaled \$794,136. The increase in accounts receivable at March 31, 2022 as compared with December 31, 2021 corresponds to the higher revenue recognized in 2022 from newer customer contracts. At March 31, 2022 and December 31, 2021 there were allowances for doubtful accounts included in accounts receivable of \$17,827 and \$0, respectively. Bad debt expense was of \$17,827 and \$0 for the three-month periods ended March 31, 2022, and 2021, respectively.

Contract assets include unbilled amounts typically resulting from sales under contracts when the cost-to-cost method of revenue recognition is utilized, and revenue recognized exceeds the amount billed to the customer. Contract assets are recorded at the net amount expected to be billed and collected. Contract assets decreased \$300,616 in the first three months of 2022, primarily due to the timing of the billing for the recognition of revenue related to the satisfaction or partial satisfaction of performance obligations. We expect to bill our customers for the March 31, 2022 contract assets in 2022.

NAUTICUS ROBOTICS, INC.
NOTES TO CONDENSED FINANCIAL STATEMENTS
(UNAUDITED)

2. Summary of Significant Accounting Policies (cont.)

Contract liabilities include billings in excess of revenue recognized and accrual of certain contract obligations. During 2020, we received a customer down payment of \$1,807,161 for a service contract of which of \$161,478 was recognized as revenue during quarter ended March 31, 2021. Contract liabilities at December 31, 2021 included \$306,791 of billings in excess of revenue recognized and \$67,000 for contract completion obligations associated with a customer contract for a modified Aquanaut vehicle. These amounts were recognized in the statements of operations during the three months ended March 31, 2022.

Capitalized Interest — The Company capitalizes interest costs incurred to Work in Process during the related construction periods. Capitalized interest is charged to cost of revenue as the related completed project is delivered to the buyer. During the three-month period ended March 31, 2022, the Company incurred \$841,294 of interest of which \$34,467 was capitalized in Work in Process to both inventory and property and equipment of which \$806,827 was included in Interest Expense, net in the Statement of Earnings. During the three-month period ended March 31, 2021, the Company incurred \$61,738 of interest, all of which was included in Interest Expense, net in the Statement of Operations.

Earnings (Loss) per Share — Basic earnings per share is computed by dividing income by the weighted average number of shares of common stock outstanding during the period. Diluted earnings per share is computed in the same manner as basic earnings per share except that the denominator is increased to include the number of additional shares of common stock that could have been outstanding assuming the exercise of stock options and conversion of convertible debt.

During the first three months of 2022 and 2021, the Company incurred net losses; as such, the impact of any incremental shares would be anti-dilutive.

Major Customer and Concentration of Credit Risk — The Company has a limited number of customers. During the first three months of 2022, sales to one customer accounted for 95% of total revenue and the total balance due from this customer as of March 31, 2022, made up 95% of accounts receivable. During the first three months of 2021, sales to two customers accounted for 100% of total revenue and the balances due from these customers as of December 31, 2021, made up 86% of accounts receivable. No other customer represented more than 10% of revenue in either three-month period.

Reclassifications — Financial statements presented for prior periods include reclassifications that were made to conform to the current-year presentation.

Recent Accounting Pronouncements — In June 2016, the FASB issued ASU2016-13, *Financial Instruments — Credit Losses*, which replaces the existing incurred loss impairment model with a methodology that reflects expected credit losses and requires consideration of a broader range of reasonable and supportable information to inform credit loss estimates. The Company adopted this standard on January 1, 2022. There was no impact from the adoption of this standard on the Company's financial statements.

There are no other new accounting pronouncements that are expected to have a material impact on the Company's financial statements.

3. Property and Equipment

Property and equipment consisted of the following:

	Useful Life (years)	March 31, 2022	December 31, 2021
Leasehold improvements	5.1	\$ 789,839	\$ 789,839
Property & equipment	5	1,222,175	1,216,609
Technology	5	1,159,253	773,535
Work in progress		1,434,174	150,220
Total		4,605,441	2,930,203
Less accumulated depreciation		(1,604,211)	(1,492,892)
Total property and equipment, net		<u>\$ 3,001,230</u>	<u>\$ 1,437,311</u>

NAUTICUS ROBOTICS, INC.
NOTES TO CONDENSED FINANCIAL STATEMENTS
(UNAUDITED)

4. Notes Payable

Notes payable consisted of the following:

	March 31, 2022	December 31, 2021
Schlumberger Technology Corp. contingently convertible promissory note	\$ 1,500,000	\$ 1,500,000
Transocean Inc. contingently convertible promissory note	1,500,000	1,500,000
Goradia Capital LLC contingently convertible promissory note	5,000,000	5,000,000
Material Impact Fund II, LP contingently convertible promissory note	5,000,000	5,000,000
In-Q-Tel, Inc. contingently convertible promissory note	250,000	250,000
RCB Equities #1, LLC term loan credit agreement	14,757,896	14,708,333
Total	28,007,896	27,958,333
Less: current portion, unrelated parties	(10,250,000)	(10,250,000)
current portion, related parties	(3,000,000)	(3,000,000)
Total notes payable – long-term	<u>\$ 14,757,896</u>	<u>\$ 14,708,333</u>

Schlumberger Technology Corp. Contingently Convertible Promissory Note — In July 2020, the Company issued an unsecured convertible promissory note to Schlumberger Technology Corp. (“Schlumberger”), a related party. There were two advances of \$750,000 each under the note made by Schlumberger upon achievement of key project development milestones. The Company received both advances in 2020.

The convertible promissory note bears interest at 4.25% and, as amended, matures on the earliest to occur of the following dates: (1) the issuance of a new series of preferred stock, (2) upon the occurrence of an event of default, or (3) December 31, 2022. In the event that an issuance by the Company of a new series of preferred stock occurs before an event of default or December 31, 2022, outstanding principal and unpaid accrued interest shall be converted into the new series of preferred stock at a conversion price of 90% of the issuance price per share of such new series.

An amendment to the promissory note executed on December 16, 2021, added another conversion option that in the event of the consummation of the merger between Nauticus and CleanTech occurring earlier than the other conversion options listed above, allows Schlumberger to convert the outstanding principal and unpaid accrued interest into Nauticus common shares at a conversion price of \$35.52 per share.

Transocean Inc. Contingently Convertible Promissory Note — In December 2020, the Company issued an unsecured convertible promissory note to Transocean Inc. (“Transocean”), a related party. There was one advance of \$1,000,000 and another of \$500,000 under the note made by Transocean upon achievement of key project development milestones. The Company received both advances in 2020.

The convertible promissory note bears interest at 10% and, as amended, matures on the earliest to occur of the following dates: (1) the issuance of a new series of preferred stock, (2) upon the occurrence of an event of default, or (3) December 31, 2022. In the event that an issuance by the Company of a new series of preferred stock occurs prior to the earlier of an event of default or December 31, 2022, outstanding principal balance and unpaid accrued interest shall be converted into the new series of preferred stock at a conversion price of 90% of the issuance price per share of such new series.

An amendment to the promissory note executed on December 16, 2021, added another conversion option that in the event of the consummation of the merger between Nauticus and CleanTech occurring earlier than the other conversion options listed above, allows Transocean to convert the outstanding principal and unpaid accrued interest into Nauticus common shares at a conversion price of \$35.52 per share.

Goradia Capital, LLC Contingently Convertible Promissory Note — On June 19, 2021, the Company issued an unsecured convertible promissory note to Goradia Capital, LLC (“Goradia”) in the amount of \$5,000,000. The amount was funded upon execution of the agreement.

NAUTICUS ROBOTICS, INC.
NOTES TO CONDENSED FINANCIAL STATEMENTS
(UNAUDITED)

4. Notes Payable (cont.)

The convertible promissory note bears interest at 10% and, as amended, matures on the earliest to occur of the following dates: (1) the issuance of a new series of preferred stock, (2) upon the occurrence of a change of control, or (3) December 31, 2022. In the event that an issuance by the Company of a new series of preferred stock occurs before a change of control or December 31, 2022, outstanding principal and unpaid accrued interest shall be converted into the new series of preferred stock at a conversion price of the lower of: (1) 90% of the issuance price per share of such new series and (2) the price per share equal to an amount obtained by dividing (x) \$75,000,000 by (y) the fully diluted shares outstanding of the Company as of June 19, 2021, which equals \$37.01.

An amendment to the promissory note executed on December 16, 2021, added another conversion option that in the event of the consummation of the merger between Nauticus and CleanTech occurring earlier than the other conversion options listed above, allows Goradia to convert the outstanding principal and unpaid accrued interest on the promissory note into Nauticus common shares at a conversion price of \$35.52 per share.

Material Impact Fund II, L.P. Contingently Convertible Promissory Note — On August 3, 2021, the Company issued an unsecured convertible promissory note to Material Impact Fund II, L.P. (“MIF”) in the amount of \$5,000,000. The amount was funded upon execution of the agreement.

The convertible promissory note bears interest at 5% and matures on the earliest to occur of the following dates: (1) the issuance of a new series of preferred stock, (2) upon the occurrence of a change of control, or (3) December 31, 2022. In the event that an issuance by the Company of a new series of preferred stock occurs before a change of control or December 31, 2022, outstanding principal and unpaid accrued interest shall be converted into the new series of preferred stock at a conversion price of the lower of: (1) 90% of the issuance price per share of such new series and (2) the price per share equal to an amount obtained by dividing (x) \$75,000,000 by (y) the fully diluted shares outstanding of the Company as of August 3, 2021, which equals \$37.01.

An amendment to the promissory note executed on December 16, 2021, added another conversion option that in the event of the consummation of the merger between Nauticus and CleanTech occurring earlier than the other conversion options listed above, allows MIF to convert the outstanding principal and unpaid accrued interest into Nauticus common shares at a conversion price of \$35.52 per share.

In-Q-Tel, Inc. Contingently Convertible Promissory Note — On October 22, 2021, the Company issued an unsecured convertible promissory note to In-Q-Tel, Inc. (“IQT”) in the amount of \$250,000. The amount was funded upon execution of the agreement.

The convertible promissory note bears interest at 5% and matures on the earliest to occur of the following dates: (1) the issuance of a new series of preferred stock with gross proceeds to the Company of at least \$10,000,000, (2) upon the occurrence of a change of control, or (3) December 31, 2022. In the event that an issuance by the Company of a new series of preferred stock occurs before a change of control or December 31, 2022, outstanding principal and unpaid accrued interest shall be converted into the new series of preferred stock at a conversion price of the lower of: (1) 90% of the issuance price per share of such new series and (2) the price per share equal to an amount obtained by dividing (x) \$75,000,000 by (y) the fully diluted shares outstanding of the Company as of August 3, 2021, which equals \$37.01.

An amendment to the promissory note executed on December 16, 2021, added another conversion option that in the event of the consummation of the merger between Nauticus and CleanTech occurring earlier than the other conversion options listed above, allows IQT to convert the outstanding principal and unpaid accrued interest into Nauticus common shares at a conversion price of \$35.52 per share.

NAUTICUS ROBOTICS, INC.
NOTES TO CONDENSED FINANCIAL STATEMENTS
(UNAUDITED)

4. Notes Payable (cont.)

RCB Equities #1, LLC Term Loan Credit Agreement— On December 16, 2021, the Company entered into a Term Loan Credit Agreement with RCB Equities #1, LLC (“RCB”) in the amount of \$15,000,000 to provide funds for the Company’s working capital and general corporate purposes. The note bears interest at 13% per annum and is payable in 18 monthly installments of interest only through its maturity date of June 16, 2023. A 2% commitment fee totaling \$300,000 was paid upon loan inception and is presented as a debt discount. There is also a 5% exit fee totaling \$750,000 is payable at the maturity date and is being accrued over the note term. If the merger with CleanTech occurs prior to the maturity date, then within three days of the consummation of the merger, the note is due in full including all accrued and unpaid interest and fees. The outstanding principal balance of the note was \$14,757,896 at March 31, 2022 and its effective interest rate is approximately 17.7%.

5. Leases

The Company leases its office and manufacturing facility under a 64-month operating lease expiring April 30, 2024. The lease includes rent escalations and chargebacks to the Company for build-out costs. The right-of-use asset and lease liability amounts were determined using an 8% discount rate which was the interest rate related to the leasehold improvement obligation.

The operating lease includes a leasehold improvement obligation of \$190,650 which bears interest at 8% and matures on April 30, 2024. The balance of this obligation was \$86,735 and \$96,375 as of March 31, 2022, and December 31, 2021, respectively, and is included in operating lease liabilities in the balance sheets.

Total operating lease expense, which is accounted for in cost of revenue, was as follows:

	For the three months ended, March 31,	
	2022	2021
Fixed lease expense	\$ 67,691	\$ 67,496
Variable lease expense	46,008	44,508
Total	\$ 113,699	\$ 112,004

6. Commitments and Contingencies

Litigation — From time to time, the Company may be subject to litigation and other claims in the normal course of business. No amounts have been accrued in the financial statements as of March 31, 2022, with respect to any matters.

The Company would be committed to pay the following advisory fees to investment banks related to Cleantech Acquisition listed below upon closing of the business combination.

Capital Markets Advisory Services Related to Cleantech Acquisition — In order to broaden Nauticus’ reach to additional potential investors, parties have entered into a few letter agreements with investment banks for their capital markets advisory services.

Pursuant to a letter agreement dated February 28, 2022 with Lake Street Capital Markets (“Lake Street”), Nauticus has agreed to pay Lake Street a non-refundable retainer of \$350,000 within ten days following the closing of the Business Combination for Lake Street’s capital markets advisory services which include, among other things, (i) providing advice and assistance to CLAQ in evaluating its capital raising strategies and alternatives; (ii) assisting CLAQ in refining and communicating its investor presentation; and (iii) working and coordinating with CLAQ’s investors relations resources to conduct a non-deal investor roadshow in the U.S. and solicit, and analyse investors’ feedback.

NAUTICUS ROBOTICS, INC.
NOTES TO CONDENSED FINANCIAL STATEMENTS
(UNAUDITED)

6. Commitments and Contingencies (cont.)

Pursuant to a letter agreement dated March 23, 2022 with Cowen and Company, LLC (“Cowen”), Nauticus has agreed to pay Cowen an advisory fee of \$1,750,000 (the “Business Combination Fee”) upon closing of the Business Combination for its capital market advisory services which include, among other things, (i) familiarizing itself with the business, properties and operation of each of CLAQ and Nauticus; (ii) advising Nauticus on investor outreach, assisting Nauticus in scheduling and arranging meetings with current and potential holders of its securities; and (iii) assisting Nauticus in formulating a marketing strategy for the Business Combination. If this agreement with Cowen is terminated, the Business Combination Fee will still be payable if a business combination is consummated within twelve months from the date of the termination of the agreement (the “Residual Period”). If during the term of this agreement with Cowen or the Residual Period, Nauticus proposes to affect any restructuring, acquisition or disposition, or certain sales of securities, Nauticus has agreed to engage Cowen and offer Cowen no less than 35% of the total economics for any such capital raising transaction.

Pursuant to an amended and restated letter agreement dated April 25, 2022 with Coastal Equities, Inc. (“Coastal”), Nauticus has agreed to pay Coastal a cash fee of \$7,600,000 (“Cash Fee”) upon closing of the Business Combination or any other transaction defined as a “Sale” of Nauticus pursuant to the letter agreement in return for Coastal’s financial advisory services which include, among other things, (i) facilitating potential purchasers’ or financing participants’ due diligence investigation; (ii) performing valuation analyses; (iii) identifying opportunities for the Sale of Nauticus; and (iv) as requested by Nauticus, participating on Nauticus’ behalf in negotiations concerning such Sale. If this letter agreement with Coastal is terminated, the Cash Fee will still be payable if the Sale of Nauticus occurs within 9 months from March 29, 2022, the effective date of the letter agreement.

7. Income Taxes

Income tax provisions for interim quarterly periods are generally based on an estimated annual effective income tax rate calculated separately from the effect of significant, infrequent, or unusual items related specifically to interim periods. No income tax expense was recognized for the periods ended March 31, 2022, and March 31, 2021, as the Company expects no taxable income and has a full valuation allowance offsetting deferred tax assets.

8. Equity

Common Stock — A total of 680,600 shares of common stock were outstanding at March 31, 2022.

Series A Preferred Stock — The Company has 334,800 shares of Series A Preferred Stock outstanding. Each share of the Series A Preferred Stock may be converted at the holder’s option into common stock of the Company at a conversion price of \$8.96 for each share of Series A Preferred Stock. The Series A Preferred Stock possesses full voting rights, on an as-converted basis, with the common stock of the Company, and has no stated dividend rate. Holders of Series A Preferred Stock are entitled to dividends at the same rate payable on the Company’s common stock should a common stock dividend be declared. The Series A Preferred Stock has priority rights in a liquidation, wind-up, sale, or merger of the Company.

Series B Preferred Stock — The Company has 725,426 shares of Series B Preferred Stock outstanding. Each share of the Series B Preferred Stock may be converted at the holder’s option into common stock of the Company at a conversion price of \$27.57 for each share of Series B Preferred Stock. The Series B Preferred Stock possesses full voting rights, on an as-converted basis, with the common stock of the Company, and has no stated dividend rate. Holders of Series B Preferred Stock are entitled to dividends at the same rate payable on the Company’s common stock should a common stock dividend be declared. The Series B Preferred Stock has priority rights in a liquidation, wind-up, sale, or merger of the Company.

Common Stock Repurchase Agreements — The Company entered into agreements with its stockholders and option holders for the repurchase at the Company’s option of up to 950,000 shares of outstanding common stock at prices based upon agreed valuation formulas. The Company is not obligated to make such repurchases but may exercise its rights under these agreements at any time on or after the separation or retirement of the stockholder

NAUTICUS ROBOTICS, INC.
NOTES TO CONDENSED FINANCIAL STATEMENTS
(UNAUDITED)

8. Equity (cont.)

from employment at the Company. Repurchased shares are held as treasury shares at their cost. The payment for repurchased shares is, at the Company's option, either (a) made in full at the time of repurchase, or (b) made over a 24-month period.

Stock-Based Compensation — The Company has a stock-based compensation plan under which stock options may be granted as incentive compensation. At March 31, 2022, 5,430 shares were available under the current plan for future award.

Options vest assuming continuous service to the Company with 25% of the options vesting one year after grant and the balance vesting in a series of 36 successive equal monthly installments measured from the first anniversary of grant. During the vesting period, the participants have voting rights, but the options may not be sold, assigned, transferred, pledged, or otherwise encumbered. Unvested shares are forfeited upon termination of employment and vested shares may be repurchased by the Company at its option.

Compensation expense for option awards totaled \$200,156 for the three months ended March 31, 2022, and \$107,794 for the three months ended March 31, 2021. As of March 31, 2022, there was \$2,069,694 of total unrecognized compensation cost related to options to be recognized over a remaining weighted average period of 29 months.

The following table summarizes options outstanding, as well as activity for the periods presented:

	Shares	Weighted Average Grant Date Fair Value	Weighted Average Exercise Price
Outstanding as of December 31, 2020	165,100	\$ 10.90	\$ 22.63
Forfeited	(750)	13.26	27.57
Outstanding as of March 31, 2021	<u>164,350</u>	<u>\$ 10.88</u>	<u>\$ 24.08</u>
Outstanding as of December 31, 2021	277,848	\$ 12.99	\$ 24.75
Granted	7,500	18.42	35.32
Forfeited	(5,300)	18.17	35.07
Outstanding as of March 31, 2022	<u>280,048</u>	<u>\$ 12.65</u>	<u>\$ 26.20</u>

The remaining weighted average contractual life of exercisable options at March 31, 2022 was 6.25 years.

9. Related Party Transactions

Contingently Convertible Promissory Notes — In 2020, Nauticus issued convertible promissory notes to Schlumberger and Transocean, each with an amount of \$1,500,000. These notes were modified in December 2021. As of March 31, 2022, Schlumberger N.V. owned 29.7% and Transocean Ltd. owned 31.3% of the voting stock of Nauticus. See Note 4 for more information about the contingently convertible notes.

Revenue and Accounts Receivable — Revenue from Transocean Ltd. for contract services and products totaled \$0 and \$141,265 for the three months ended March 31, 2022, and 2021, respectively. Accounts receivable included \$0 and \$15,000 outstanding from Transocean Ltd. at March 31, 2022 and 2021, respectively.

NAUTICUS ROBOTICS, INC.
NOTES TO CONDENSED FINANCIAL STATEMENTS
(UNAUDITED)

10. Earnings (Loss) Per Share

The following table is a calculation of the net earnings (loss) per basic and diluted share:

	March 31,	
	2022	2021
Numerator		
Net loss	\$ (3,504,002)	\$ (1,519,682)
Denominator		
Weighted average shares used to compute basic EPS	680,600	678,400
Dilutive effect of stock-based awards	—	—
Weighted average shares used to compute diluted EPS	<u>680,600</u>	<u>678,400</u>
Loss per share		
Basic	\$ (5.15)	\$ (2.24)
Diluted	\$ (5.15)	\$ (2.24)

Diluted EPS for March 31, 2022, and March 31, 2021, excludes 280,048 and 164,350 options, respectively, along with the shares related to the contingently convertible debt, because their effect would be anti-dilutive.

11. Subsequent Events

In preparing the condensed financial statements, the Company has evaluated all subsequent events and transactions for potential recognition or disclosure through May 16, 2022, the date the financial statements were available for issuance.

Capital Markets Advisory Services Related to Cleantech Acquisition — In order to broaden Nauticus' reach to additional potential investors, parties have entered into a few letter agreements with investment banks for their capital markets advisory services. See Note 6 for more details of letter agreements in regards with Lake Street Capital Markets and Cowen and Company, LLC. Also see below a subsequent letter agreement with Coastal Equities, Inc.

Pursuant to an amended and restated letter agreement dated April 25, 2022 with Coastal Equities, Inc. ("Coastal"), Nauticus has agreed to pay Coastal a cash fee of \$7,600,000 ("Cash Fee") upon closing of the Business Combination or any other transaction defined as a "Sale" of Nauticus pursuant to the letter agreement in return for Coastal's financial advisory services which include, among other things, (i) facilitating potential purchasers' or financing participants' due diligence investigation; (ii) performing valuation analyses; (iii) identifying opportunities for the Sale of Nauticus; and (iv) as requested by Nauticus, participating on Nauticus' behalf in negotiations concerning such Sale. If this letter agreement with Coastal is terminated, the Cash Fee will still be payable if the Sale of Nauticus occurs within 9 months from March 29, 2022, the effective date of the letter agreement.

Wood, PLC Memorandum of Understanding — During April 2022, Nauticus signed a Memorandum of Understanding with Wood, PLC, an engineering and consulting firm in the United Kingdom for the purpose of jointly pursuing subsea inspection services for oil & gas and wind markets. Pursuant to the Memorandum of Understanding agreement, each party thereto will utilize its expertise and capabilities to deliver subsea inspection services to the target markets defined therein.

AGREEMENT AND PLAN OF MERGER

dated as of

December 16, 2021

by and among

CLEANTECH ACQUISITION CORP.,

CLEANTECH MERGER SUB, INC.,

NAUTICUS ROBOTICS, INC.

and

Nicolaus Radford, solely in his capacity as the Stockholder Representative

TABLE OF CONTENTS

	Annex A Page No.
ARTICLE I CERTAIN DEFINITIONS	A-2
1.01 Definitions	A-2
1.02 Construction	A-13
1.03 Knowledge	A-14
ARTICLE II THE MERGER; CLOSING	A-14
2.01 The Merger	A-14
2.02 Effects of the Merger	A-14
2.03 Closing	A-14
2.04 Organizational Documents of Acquiror and the Surviving Company	A-14
2.05 Directors and Officers of Acquiror and the Surviving Company	A-15
ARTICLE III EFFECTS OF THE MERGER	A-15
3.01 Effect on Securities	A-15
3.02 Equitable Adjustments	A-16
3.03 Delivery of Merger Consideration	A-16
3.04 Uncertificated Securities	A-16
3.05 Treatment of Company Options	A-17
3.06 Earnout	A-17
3.07 Withholding	A-19
3.08 No Fractional Shares	A-19
3.09 Payment of Expenses	A-19
3.10 Dissenting Shares	A-20
ARTICLE IV REPRESENTATIONS AND WARRANTIES OF THE COMPANY	A-20
4.01 Corporate Organization of the Company	A-20
4.02 No Subsidiaries	A-21
4.03 Due Authorization	A-21
4.04 No Conflict	A-21
4.05 Governmental Authorities; Consents	A-21
4.06 Capitalization	A-21
4.07 Financial Statements	A-22
4.08 Undisclosed Liabilities	A-23
4.09 Litigation and Proceedings	A-23
4.10 Compliance with Laws	A-23
4.11 Intellectual Property	A-24
4.12 Contracts; No Defaults	A-26
4.13 Company Benefit Plans	A-27
4.14 Labor Matters	A-28
4.15 Taxes	A-29
4.16 Brokers' Fees	A-30
4.17 Insurance	A-30
4.18 Real Property; Assets	A-31
4.19 Environmental Matters	A-31
4.20 Absence of Changes	A-32
4.21 Affiliate Agreements	A-32
4.22 Internal Controls	A-32

[Table of Contents](#)

	Annex A Page No.
4.23 Permits	A-32
4.24 Registration Statement	A-32
4.26 No Additional Representations and Warranties	A-32
ARTICLE V REPRESENTATIONS AND WARRANTIES OF ACQUIROR AND MERGER SUB	
5.01 Corporate Organization	A-33
5.02 Due Authorization	A-33
5.03 No Conflict	A-34
5.04 Litigation and Proceedings	A-34
5.05 Compliance with Laws	A-35
5.06 Employee Benefit Plans	A-35
5.07 Governmental Authorities; Consents	A-36
5.08 Trust Account	A-36
5.09 Taxes	A-36
5.10 Brokers' Fees	A-37
5.11 Acquiror SEC Reports; Financial Statements; Sarbanes-Oxley Act	A-37
5.12 Business Activities; Absence of Changes	A-38
5.13 Registration Statement	A-39
5.14 No Outside Reliance	A-39
5.15 Capitalization	A-39
5.16 Nasdaq Stock Market Listing	A-40
5.17 Contracts; No Defaults	A-40
5.18 Title to Property	A-41
5.19 Investment Company Act	A-41
5.20 Affiliate Agreements	A-41
5.21 Sponsor Support Agreement	A-41
ARTICLE VI COVENANTS OF THE COMPANY	
6.01 Conduct of Business	A-41
6.02 Inspection	A-43
6.03 No Acquiror Common Stock Transactions	A-44
6.04 No Claim Against the Trust Account	A-44
6.05 Proxy Solicitation; Other Actions	A-44
ARTICLE VII COVENANTS OF ACQUIROR	
7.01 Conduct of Acquiror During the Interim Period	A-45
7.02 Trust Account	A-46
7.03 Inspection	A-46
7.04 Acquiror Nasdaq Listing	A-47
7.05 Acquiror Public Filings	A-47
7.06 Section 16 Matters	A-47
ARTICLE VIII JOINT COVENANTS	
8.01 Subscription Agreements	A-48
8.02 Support of Transaction	A-48
8.03 Preparation of Registration Statement; Special Meeting; Solicitation of Company Requisite Approval	A-48
8.04 Tax Matters	A-50
8.05 Confidentiality; Publicity	A-50

[Table of Contents](#)

	Annex A Page No.
8.06 Post-Closing Cooperation; Further Assurances	A-50
8.07 Additional Insurance and Indemnity Matters	A-50
8.08 HSR Act and Regulatory Approvals	A-52
8.09 Employee Matters	A-53
8.10 Non-Solicitation; Acquisition Proposals	A-53
ARTICLE IX CONDITIONS TO OBLIGATIONS	
	A-54
9.01 Conditions to Obligations of All Parties	A-54
9.02 Additional Conditions to Obligations of Acquiror	A-55
9.03 Additional Conditions to the Obligations of the Company	A-55
ARTICLE X TERMINATION/EFFECTIVENESS	
	A-56
10.01 Termination	A-56
10.02 Effect of Termination	A-57
ARTICLE XI MISCELLANEOUS	
	A-57
11.01 Waiver	A-57
11.02 Notices	A-57
11.03 Assignment	A-58
11.04 Rights of Third Parties	A-58
11.05 Expenses	A-58
11.06 Governing Law	A-58
11.07 Captions; Counterparts	A-58
11.08 Schedules and Exhibits	A-58
11.09 Entire Agreement	A-58
11.10 Amendments	A-59
11.11 Severability	A-59
11.12 Jurisdiction; WAIVER OF TRIAL BY JURY	A-59
11.13 Enforcement	A-59
11.14 Non-Recourse	A-59
11.15 Nonsurvival of Representations, Warranties and Covenants	A-60
11.16 Stockholder Representative	A-60
11.17 Acknowledgments	A-60

Exhibits

Exhibit A – Form of PubCo Bylaws
Exhibit B – Form of PubCo Charter
Exhibit C – Form of Acquiror Incentive Plan
Exhibit D – Form of Surviving Company Bylaws
Exhibit E – Form of Surviving Company Charter
Exhibit F – Form of Earnout Escrow Agreement
Exhibit G – Form of Director Nomination Agreement
Exhibit H – Form of Lock-Up Agreement
Exhibit I – Form of Registration Rights Agreement

AGREEMENT AND PLAN OF MERGER

This Agreement and Plan of Merger (this “Agreement”), dated as of 16, 2021, is entered into by and among CleanTech Acquisition Corp., a Delaware corporation (prior to the Effective Time, “Acquiror” and, at and after the Effective Time, “PubCo”), CleanTech Merger Sub, Inc., a Texas corporation (“Merger Sub”), Nauticus Robotics, Inc., a Texas corporation (the “Company”), and Nicolaus Radford (the “Founder”), solely in his capacity as the Stockholder Representative pursuant to the designation in Section 11.16. Acquiror, Merger Sub and the Company are sometimes referred to herein individually as a “Party” and, collectively, as the “Parties”. Except as otherwise indicated, capitalized terms used but not defined herein shall have the meanings set forth in Article I of this Agreement.

RECITALS

WHEREAS, Acquiror is a special purpose acquisition company incorporated to acquire one or more operating businesses through a Business Combination;

WHEREAS, Merger Sub is a newly formed, wholly-owned, direct subsidiary of Acquiror, and was formed for the sole purpose of the Merger;

WHEREAS, subject to the terms and conditions of this Agreement, at the Closing, Merger Sub is to merge with and into the Company pursuant to the Merger, with the Company surviving as the Surviving Company;

WHEREAS, in connection with the Merger, the stockholders of the Company will be entitled to receive merger consideration in the form of the right to receive stock in PubCo, as more fulsomely described in this Agreement;

WHEREAS, contemporaneously with the execution and delivery of this Agreement, in connection with the Transactions, the Sponsor entered into a letter agreement (the “Sponsor Support Agreement”) with Acquiror and the Company;

WHEREAS, contemporaneously with the execution and delivery of this Agreement, in connection with the Transactions, certain Company Stockholders have entered into Support Agreements (each, a “Company Support Agreement”) with the Acquiror;

WHEREAS, in connection with the Merger, Acquiror, the Company, certain Acquiror Stockholders and certain Company Stockholders who will receive common stock of PubCo (the “PubCo Common Stock”) pursuant to Article III will enter into that certain Amended and Restated Registration Rights Agreement (the “Registration Rights Agreement”), upon the Closing;

WHEREAS, simultaneously with the execution and delivery of this Agreement, the Chief Executive Officer of the Company has entered into an Employment and Non-Competition Agreement (the “Employment Agreement”), which agreement will become effective as of the Closing;

WHEREAS, prior to the date hereof, the parties hereto have conducted a private placement equity offering of the Acquiror to secure firm commitments for Fifty Million Dollars (\$50,000,000) of Equity Financing pursuant to the terms of Subscription Agreements;

WHEREAS, simultaneously with the execution of the Agreement, the Company has entered into a Securities Purchase Agreement with ATW Special Situations I, LLC (“ATW”), together with certain ancillary agreements thereto (the “ATW Convertible Note”);

WHEREAS, simultaneously with the execution of the Agreement, the Company has entered into a Term Loan Credit Agreement with RCB Equities #1, LLC, a California limited liability company (the “Bridge Loan”) and together with the ATW Convertible Note, the “Transaction Finance Loans”);

WHEREAS, in connection with the Merger, Acquiror shall adopt the amended and restated bylaws (the “PubCo Bylaws”) in the form set forth on Exhibit A;

WHEREAS, in connection with the Merger, Acquiror shall adopt, subject to obtaining the Acquiror Stockholder Approval, the amended and restated certificate of incorporation (the “PubCo Charter”) in the form set forth on Exhibit B, to provide for, among other things an increase in the number of authorized shares of PubCo’s Common Stock;

[Table of Contents](#)

WHEREAS, at the Closing, the shares of Company Common Stock (including shares of Company Preferred Stock that will be converted first into shares of Company Common Stock and then into shares of Company Common Stock as part of the Exchange), will be converted into shares of PubCo's Common Stock;

WHEREAS, pursuant to the Acquiror Organizational Documents, Acquiror shall provide an opportunity to its stockholders to have their Acquiror Common Stock redeemed for the consideration, and on the terms and subject to the conditions and limitations, set forth in this Agreement, the Acquiror Organizational Documents, the Trust Agreement, and the Proxy Statement in conjunction with, *inter alia*, obtaining approval from the stockholders of Acquiror for the Business Combination (the "Offer");

WHEREAS, prior to the consummation of the Transactions, Acquiror shall, subject to obtaining the Acquiror Stockholder Approval, adopt the stock incentive plan (the "Acquiror Incentive Plan") in the form set forth on Exhibit C;

WHEREAS, each of the parties intends that, for U.S. federal income tax purposes, (i) the Merger will qualify as a "reorganization" within the meaning of Section 368(a) of the Internal Revenue Code of 1986, as amended (the "Code") and the Treasury Regulations and (ii) this Agreement be adopted as a "plan of reorganization" for purposes of Section 368 of the Code and Treasury Regulations Section 1.368-2(g) (the "Intended Tax Treatment"); and

WHEREAS, the respective boards of directors or similar governing bodies of each of Acquiror, Merger Sub and the Company have each (i) approved and declared advisable the Transactions upon the terms and subject to the conditions of this Agreement and in accordance with the DGCL (as defined below) and the Texas Business Organizations Code (the "TBOC") and (ii) recommended to their respective stockholders the approval and adoption of this Agreement and the Transactions.

NOW, THEREFORE, in consideration of the foregoing and the respective representations, warranties, covenants and agreements set forth in this Agreement, and intending to be legally bound hereby, Acquiror, Merger Sub and the Company agree as follows:

**ARTICLE I
CERTAIN DEFINITIONS**

1.01 Definitions. As used herein, the following terms shall have the following meanings:

"Acquiror" has the meaning specified in the preamble hereto.

"Acquiror Affiliate Agreement" has the meaning specified in Section 5.20.

"Acquiror and Merger Sub Representations" means the representations and warranties of each of Acquiror and Merger Sub expressly and specifically set forth in Article V of this Agreement, as qualified by the Acquiror and Merger Sub Schedules. For the avoidance of doubt, the Acquiror and Merger Sub Representations are solely made by Acquiror and Merger Sub.

"Acquiror and Merger Sub Schedules" means the disclosure schedules of Acquiror and Merger Sub.

"Acquiror Benefit Plans" has the meaning set forth in Section 5.06.

"Acquiror Board" means the board of directors of Acquiror.

"Acquiror Board Recommendation" has the meaning specified in Section 8.03(d).

"Acquiror Common Stock" means Acquiror's Common Stock, par value \$0.0001 per share.

"Acquiror Cure Period" has the meaning specified in Section 10.01(c).

"Acquiror Incentive Plan" has the meaning specified in the recitals hereto.

"Acquiror Incentive Plan Proposal" has the meaning specified in Section 8.03(c).

"Acquiror Organizational Documents" means the Certificate of Incorporation and Acquiror's bylaws, in each case as may be amended from time to time in accordance with the terms of this Agreement.

[Table of Contents](#)

“Acquiror Private Placement Warrants” has the meaning ascribed to it in the Acquiror SEC Reports as of the date of this Agreement.

“Acquisition Proposal” has the meaning specified in Section 6.06(b).

“Acquiror Public Warrant” has the meaning ascribed to it in the Acquiror SEC Reports as of the date of this Agreement.

“Acquiror Rights” means Acquiror’s right to receive one-twentieth of one share of Acquiror Common Stock upon the happening of an Acquiror initial business combination (as such event is described in the Acquiror Organizational Documents).

“Acquiror SEC Reports” has the meaning specified in Section 5.11(a).

“Acquiror Stockholder” means a holder of Acquiror Common Stock.

“Acquiror Stockholder Approval” has the meaning specified in Section 5.02(b).

“Acquiror Units” means the units of the Acquiror issued in connection with its initial public offering, which such units are comprised of one share of Acquiror Common Stock, one Acquiror Right, and one-half of one Acquiror Public Warrant.

“Acquiror Warrants” means, collectively, the Acquiror Public Warrants and the Acquiror Private Placement Warrants.

“Action” means any claim, action, suit, assessment, arbitration or proceeding, in each case that is by or before any Governmental Authority.

“Additional Proposal” has the meaning specified in Section 8.03(c).

“Affiliate” means, with respect to any specified Person, any Person that, directly or indirectly, controls, is controlled by, or is under common control with, such specified Person, through one or more intermediaries or otherwise.

“Agreement” has the meaning specified in the preamble hereto.

“Amendment Proposal” has the meaning specified in Section 8.02(c).

“Ancillary Agreements” means this Agreement, PubCo Bylaws, PubCo Charter, the Sponsor Agreement Amendment, the Company Support Agreements, the Earnout Escrow Agreement, the Registration Rights Agreement, the Employment Agreement, the Lock-up Agreements and all the agreements, documents, instruments and certificates entered into in connection herewith or therewith and any and all exhibits and schedules thereto.

“Anti-Corruption Laws” means any applicable Laws relating to anti-bribery or anti-corruption (governmental or commercial), including the U.S. Foreign Corrupt Practices Act, as amended (FCPA), and the U.S. Travel Act, 18 U.S.C. § 1952.

“Antitrust Law” means the HSR Act, the Federal Trade Commission Act, as amended, the Sherman Act, as amended, the Clayton Act, as amended, and any applicable foreign antitrust Laws and all other applicable Laws that are designed or intended to prohibit, restrict or regulate actions having the purpose or effect of monopolization or restraint of trade or lessening of competition through merger or acquisition.

“ATW Convertible Note” has the meaning specified in the recitals hereto.

“Audited Financial Statements” has the meaning specified in Section 4.07.

“Bridge Loan” has the meaning specified in the recitals hereto.

“Business Combination” has the meaning ascribed to such term in the Certificate of Incorporation.

“Business Combination Proposal” has the meaning set forth in Section 7.07.

[Table of Contents](#)

“Business Day” means a day other than a Saturday, Sunday or other day on which commercial banks in New York, New York or Houston, Texas are authorized or required by Law to close.

“Certificate of Incorporation” means the Amended and Restated Certificate of Incorporation of Acquiror, filed with the Secretary of State of the State of Delaware on January 14, 2021.

“Certificate of Merger” has the meaning specified in [Section 2.01](#).

“Claim” means any demand, claim, action, legal, judicial or administrative proceeding (whether at law or in equity) or arbitration.

“Closing” has the meaning specified in [Section 2.03](#).

“Closing Date” has the meaning specified in [Section 2.03](#).

“Closing Share Price” means \$10.00 per share.

“Code” has the meaning specified in the recitals hereto.

“Company” has the meaning specified in the preamble hereto.

“Company Affiliate Agreement” has the meaning specified in [Section 4.21](#).

“Company Benefit Plan” has the meaning specified in [Section 4.13\(a\)](#).

“Company Board” means the board of directors of the Company.

“Company Board Recommendation” has the meaning specified in [Section 8.03\(e\)](#).

“Company Capital Stock” means, as applicable, Company Common Stock and Company Preferred Stock.

“Company Certificate of Incorporation” means the Second Amended and Restated Certificate of Formation of the Company, as amended.

“Company Common Stock” has the meaning specified in [Section 4.06\(a\)](#).

“Company Convertible Notes” means (1) that certain Unsecured Convertible Promissory Note, dated June 19, 2021, by and between Goradia Capital, LLC and the Company, as amended on December 16, 2021, (2) that certain Unsecured Convertible Promissory Note, August 3, 2021, by and between Material Impact Fund II, L.P. and the Company, as amended on December 16, 2021, (3) that certain Unsecured Convertible Promissory Note, dated October 22, 2021, by and between In-Q-Tel, Inc. and the Company, as amended on December 16, 2021, (4) that certain Unsecured Convertible Promissory Note, dated July 28, 2020, by and between Schlumberger Technology Corporation and the Company, as amended on December 16, 2021 and (5) that certain Unsecured Convertible Promissory Note, dated December 7, 2020, by and between Transocean Inc. and the Company, as amended on December 16, 2021.

“Company Convertible Note Conversion” has the meaning specified in [Section 3.01\(a\)](#).

“Company Cure Period” has the meaning specified in [Section 10.01\(b\)](#).

“Company Intellectual Property” means all Owned Intellectual Property and all Intellectual Property used in, or necessary for the conduct of the business of the Company, as currently conducted.

“Company Option” has the meaning specified in [Section 3.05\(a\)](#).

“Company Preferred Stock” has the meaning specified in [Section 4.06\(a\)](#).

“Company Preferred Stock Conversion” has the meaning specified in [Section 3.01\(c\)](#).

“Company Representations” means the representations and warranties of the Company expressly and specifically set forth in [Article IV](#) of this Agreement, as qualified by the Company Schedules. For the avoidance of doubt, the Company Representations are solely made by the Company.

“Company Requisite Approval” has the meaning specified in Section 4.03.

“Company Schedules” means the disclosure schedules of the Company.

“Company Software” means all Owned Company Software and third party Software used in, or necessary for the conduct of, the business of the Company, as currently conducted.

“Company Stockholder” means the holder of either a share of Company Common Stock or a share of Company Preferred Stock.

“Company Stock Plan” means the Company’s 2015 Equity Incentive Plan.

“Company Support Agreements” has the meaning specified in the recitals.

“Confidential Data” means all data for which the Company is required by Law, Contract or privacy policy to keep confidential or private, including all such data transmitted to the Company by customers of the Company or Persons that interact with the Company.

“Confidentiality Agreement” has the meaning specified in Section 11.09.

“Consent Solicitation Statement” means the consent solicitation statement with respect to the solicitation by the Company of the Company Requisite Approval.

“Contracts” means any legally binding contracts, agreements, subcontracts, leases, and purchase orders (other than any Company Benefit Plans).

“Copyright Terms” has the meaning specified in Section 4.11(g).

“COVID-19” means SARS-CoV-2 or COVID-19, and any evolutions thereof or any other epidemics, pandemics or disease outbreaks.

“COVID-19 Action” means an inaction or action by the Company, including the establishment of any policy, procedure or protocol, in response to COVID-19 or any COVID-19 Measures (i) that is consistent with the past practice of the Company in response to COVID-19 prior to the date of this Agreement (but only to the extent in compliance with applicable Law), or (ii) that would, given the totality of the circumstances under which the Company acted or did not act, be unreasonable for Acquiror to withhold, condition or delay consent with respect to such action or inaction (whether or not Acquiror has a consent right with respect thereto).

“COVID-19 Measures” means any quarantine, “shelter in place,” “stay at home,” workforce reduction, social distancing, shut down, closure, sequester or any other Law, Governmental Order, Action, directive, guidelines or recommendations by any Governmental Authority in connection with or in response to COVID-19, including, but not limited to, the Coronavirus Aid, Relief, and Economic Security (CARES) Act.

“DGCL” means the Delaware General Corporation Law.

“Director Nomination Agreement” has the meaning specified in Section 9.02(e).

“Dissenting Shares” has the meaning specified in Section 3.10.

“DTC” has the meaning specified in Section 3.06(a).

“Earnout Escrow Account” has the meaning specified in Section 3.06(b)(i).

“Earnout Escrow Agent” has the meaning specified in Section 3.06(b)(i).

“Earnout Escrow Agreement” has the meaning specified in Section 3.06(b)(i).

“Earnout Shares” means the shares of PubCo Common Stock that have been placed into escrow and are subject to forfeiture pursuant to Section 3.06.

“Effective Time” has the meaning specified in Section 2.01.

“Environmental Laws” means any and all applicable Laws relating to pollution, protection of the environment (including natural resources) and human health and safety, or the use, storage, emission, disposal or release of or exposure to Hazardous Materials.

“Equity Financing” means the aggregate amount of cash actually invested in (or contributed to) Acquiror by the Equity Investors pursuant to any Subscription Agreements.

“Equity Investor” means any Person that is a party to a Subscription Agreement.

“Equity Value” means the sum of (i) Three Hundred Million (\$300,000,000) plus (ii) (A) the amount of the aggregate exercise price of all Company Options that are outstanding and unexercised immediately prior to the Effective Time and (B) the amount by which (x) the outstanding liabilities and obligations of Acquiror with respect to the Transactions (including with respect to Indebtedness of Acquiror and Outstanding Acquiror Expenses) at the Closing (but prior to repayment thereof at the Closing) exceeds (y) \$35,000,00. For the avoidance of doubt, the amount described in sub-clause (ii) of this definition of Equity Value shall not be less than zero (0) and the Equity Value shall not be less than Three Hundred Million (\$300,000,000).

“ERISA” has the meaning specified in [Section 4.13\(a\)](#).

“ERISA Affiliate” has the meaning specified in [Section 4.13\(e\)](#).

“Exchange Act” means the Securities Exchange Act of 1934.

“Exchange Ratio” means the ratio determined by dividing (a) the Per Share Merger Consideration Value, by (b) the Closing Share Price.

“Financial Derivative/Hedging Arrangement” means any transaction (including an agreement with respect thereto) which is a rate swap transaction, basis swap, forward rate transaction, commodity swap, commodity option, equity or equity index swap, equity or equity index option, bond option, interest rate option, foreign exchange transaction, cap transaction, floor transaction, collar transaction, currency swap transaction, cross-currency rate swap transaction, currency option or any combination of these transactions.

“Financial Statements” has the meaning specified in [Section 4.07](#).

“Founder” has the meaning specified in the preamble hereto.

“Fraud” means an actual, intentional and knowing common law fraud (and not a constructive fraud, negligent misrepresentation or omission, or any form of fraud premised on recklessness or negligence), as finally determined by a court of competent jurisdiction, by (a) the Company with respect to the Company Representations and Warranties (as qualified by the Company Schedules), or (b) Acquiror or Merger Sub with respect to the Acquiror and Merger Sub Representations (as qualified by Acquiror and Merger Sub Schedules); provided that (and without limiting any of the other elements for establishing such common law fraud) such fraud shall in no event be deemed to exist in the absence of actual conscious awareness (and not imputed or constructive knowledge) by or on behalf of the Named Party sought to be held liable therefor, on the date the particular representation or warranty is made hereunder, both (i) of the particular fact, event or condition that gives rise to a breach of the applicable representation or warranty contained herein, and (ii) that such fact, event or condition actually constitutes a breach of such representation or warranty, all with the express intention of such Named Party to deceive and mislead the other party hereto.

“GAAP” means United States generally accepted accounting principles, consistently applied.

“Governmental Authority” means any federal, state, provincial, municipal, local or foreign government, governmental authority, regulatory or administrative agency, governmental commission, department, board, bureau, agency or instrumentality, arbitrator, court or tribunal.

“Governmental Order” means any order, judgment, injunction, decree, writ, stipulation, determination or award, in each case, entered by or with any Governmental Authority.

“Hazardous Material” means any material, substance or waste that is listed, regulated, or defined as “hazardous,” “toxic,” or “radioactive,” or as a “pollutant” or “contaminant” (or words of similar intent or meaning) under applicable Environmental Laws, including but not limited to petroleum, petroleum by-products, asbestos or asbestos-containing material, polychlorinated biphenyls, flammable or explosive substances, mold, per- and polyfluoroalkyl substances or pesticides.

“HSR Act” means the Hart-Scott-Rodino Antitrust Improvements Act of 1976 and the rules and regulations promulgated thereunder.

“Indebtedness” means, with respect to any Person, without duplication, any obligations (whether or not contingent) consisting of (a) the outstanding principal amount of and accrued and unpaid interest on, and other payment obligations for, borrowed money, or payment obligations issued or incurred in substitution or exchange for payment obligations for borrowed money, (b) amounts owing as deferred purchase price for property or services, including “earnout” payments, (c) payment obligations evidenced by any promissory note, bond, debenture, mortgage or other debt instrument or debt security, (d) contingent reimbursement obligations with respect to letters of credit, bankers’ acceptance or similar facilities (in each case to the extent drawn), (e) payment obligations of a third party secured by (or for which the holder of such payment obligations has an existing right, contingent or otherwise, to be secured by) any Lien, other than a Permitted Lien, on assets or properties of such Person, whether or not the obligations secured thereby have been assumed, (f) obligations under capitalized leases, (g) obligations under any Financial Derivative/Hedging Arrangement, (h) guarantees, make-whole agreements, hold harmless agreements or other similar arrangements with respect to any amounts of a type described in clauses (a) through (g) above and (i) with respect to each of the foregoing, any unpaid interest, breakage costs, prepayment or redemption penalties or premiums, or other unpaid fees or obligations; provided, however, that Indebtedness shall not include accounts payable to trade creditors and accrued expenses arising in the ordinary course of business.

“Information or Document Request” means any request or demand for the production, delivery or disclosure of documents or other evidence, or any request or demand for the production of witnesses for interviews or depositions or other oral or written testimony, by any Regulatory Consent Authority relating to the transactions contemplated hereby or by any third party challenging the transactions contemplated hereby, including any so called “second request” for additional information or documentary material or any civil investigative demand made or issued by the Antitrust Division of the United States Department of Justice or the United States Federal Trade Commission or any subpoena, interrogatory or deposition.

“Intellectual Property” means all intellectual property rights created, arising, or protected under applicable Law, including all: (i) patents, patent applications, patentable inventions and other patent rights (including any divisionals, continuations, continuations-in-part, reissues and reexaminations thereof) (collectively, “Patents”); (ii) trademarks, service marks, trade dress, trade names, taglines, social media identifiers (such as a Twitter® handle) brand names, logos, corporate names and other source identifiers and all goodwill related thereto; (iii) copyrights and designs; (iv) internet domain names; (v) trade secrets, know-how, inventions, processes, procedures, database rights, source code, confidential business information and other proprietary information and rights (collectively, “Trade Secrets”) and (vi) rights in Software.

“Intended Tax Treatment” has the meaning specified in the recitals hereto.

“Interim Period” has the meaning specified in [Section 6.01](#).

“International Trade Laws” means any Law relating to international trade, including: (i) import laws and regulations administered by U.S. Customs and Border Protection, (ii) export control regulations issued by the U.S. Department of State pursuant to the International Traffic in Arms Regulations (22 C.F.R. 120 et seq.) and/or the U.S. Department of Commerce pursuant to the Export Administration Regulations (15 C.F.R. 730 et seq.); (iii) sanctions laws and regulations as administered by the U.S. Department of the Treasury’s Office of Foreign Assets Control (31 C.F.R. Part 500 et seq.); (iv) U.S. anti-boycott laws and requirements (Section 999 of the US Internal Revenue Code of 1986, as amended, or related provisions, or under the Export Administration Act, as amended, 50 U.S.C. App. Section 2407 et seq.).

“IT Systems” means the Software, systems, servers, computers, hardware, firmware, middleware, networks, data communications lines, routers, hubs, switches and all other information technology and telecommunications assets, systems, and equipment, and all associated documentation, in each case, owned, used, held for use, leased, outsourced or licensed by or for the Company for use in the conduct of its business as it is currently conducted.

“JOBS Act” has the meaning specified in Section 7.12.

“Law” means any statute, law, ordinance, rule, regulation or Governmental Order, in each case, of any Governmental Authority.

“Leased Real Property” means all real property leased, subleased, licensed or otherwise occupied by the Company.

“Lien” means any mortgage, deed of trust, pledge, hypothecation, easement, right of way, purchase option, right of first refusal, covenant, restriction, security interest, title defect, encroachment or other survey defect, or other lien or encumbrance of any kind, except for any restrictions arising under any applicable Securities Laws.

“Lock-Up Agreement” means a lock-up agreement in the form of Exhibit H hereto.

“Material Adverse Effect” means any event, change or circumstance that has a material adverse effect on (i) the assets, business, results of operations or financial condition of the Company; provided, however, that in no event would any of the following (or the effect of any of the following), alone or in combination, be deemed to constitute, or be taken into account in determining whether there has been or will be, a “Material Adverse Effect”: (a) any change in applicable Laws or GAAP after the date hereof or any official interpretation thereof, (b) any change in interest rates or economic, political, business, financial, commodity, currency or market conditions generally, (c) the announcement or the execution of this Agreement, the pendency or consummation of the Merger or the performance of this Agreement, including the impact thereof on relationships, contractual or otherwise, with customers, suppliers, licensors, distributors, partners, providers and employees (provided, that the exceptions in this clause (c) shall not be deemed to apply to references to “Material Adverse Effect” in the representations and warranties set forth in Section 4.04 and, to the extent related thereto, the condition in Section 9.02(a)), (d) any change generally affecting any of the industries or markets in which the Company operates or the economy as a whole, (e) the compliance with the terms of this Agreement or the taking of any action required by this Agreement or with the prior written consent of Acquiror (provided, that the exceptions in this clause (e) shall not be deemed to apply to references to “Material Adverse Effect” in the representations and warranties set forth in Section 4.04 and, to the extent related thereto, the condition in Section 9.02(a)), (f) any earthquake, hurricane, tsunami, tornado, flood, mudslide, wild fire or other natural disaster, pandemic, weather condition, explosion fire, act of God or other force majeure event, including, for the avoidance of doubt, COVID-19 and any Law, directive, pronouncement or guideline issued by a Governmental Authority, the Centers for Disease Control and Prevention, the World Health Organization or any industry group providing for business closures, changes to business operations, “sheltering-in-place” or other restrictions that relate to, or arise out of, an epidemic, pandemic or disease outbreak (including the COVID-19 pandemic) or any change in such Law, directive, pronouncement or guideline or interpretation thereof following the date of this Agreement or the Company’s compliance therewith, (g) any national or international political or social conditions in countries in which, or in the proximate geographic region of which, the Company operates, including the engagement by the United States or such other countries in hostilities or the escalation thereof, whether or not pursuant to the declaration of a national emergency or war, or the occurrence or the escalation of any military or terrorist attack (including any internet or “cyber” attack or hacking) upon the United States or such other country, or any territories, possessions, or diplomatic or consular offices of the United States or such other countries or upon any United States or such other country military installation, equipment or personnel, (h) any failure of the Company to meet any projections, forecasts or budgets or (i) any actions taken, or failures to take action, or such other changes or events, in each case, which Acquiror has requested or to which it has consented; provided, that clause (h) shall not prevent or otherwise affect a determination that any change or effect underlying such failure to meet projections or forecasts has resulted in, or contributed to, or would reasonably be expected to result in or contribute to, a Material Adverse Effect (to the extent such change or effect is not otherwise excluded from this definition of Material Adverse Effect), except in the case of clause (a), (b), (d), (f) and (g) to the extent that such change does not have a disproportionate impact on the Company as compared to other industry participants or (ii) the ability of the Company to consummate the Transactions.

[Table of Contents](#)

“Material Contracts” has the meaning specified in Section 4.12(a).

“Material Permits” has the meaning specified in Section 4.23.

“Merger” has the meaning specified in Section 2.01.

“Merger Sub” has the meaning specified in the preamble hereto.

“Minimum Cash Condition” has the meaning specified in Section 9.03(h).

“Multiemployer Plan” has the meaning specified in Section 4.13(e).

“Named Parties” means (i) with respect to this Agreement, the Company, Acquiror and Merger Sub (and their permitted successors and assigns), and (ii) with respect to any Ancillary Agreement, the parties named in the preamble thereto (and their permitted successors and assigns), and “Named Party” means any of them.

“Nasdaq” means the Nasdaq Capital Market.

“NYSE” means the New York Stock Exchange.

“Offer” has the meaning specified in the recitals hereto.

“Open Source Materials” has the meaning specified in Section 4.11(f).

“Outstanding Acquiror Expenses” has the meaning specified in Section 3.09(b).

“Outstanding Company Expenses” has the meaning specified in Section 3.09(a).

“Owned Company Software” means all Software owned or purported to be owned, in whole or in part, by the Company.

“Owned Intellectual Property” means all Intellectual Property owned or purported to be owned, in whole or in part, by the Company and includes the Owned Company Software.

“PCAOB” means the U.S. Public Company Accounting Oversight Board (or any successor thereto).

“Per Share Merger Consideration” means with respect to any share of Company Common Stock, issued and outstanding immediately prior to the Effective Time, including those issued in connection with the Company Preferred Stock Conversion and the Company Convertible Note Conversion, a number of shares of Pubco’s Common Stock equal to (i) the Per Share Merger Consideration Value *divided by* (ii) the Closing Share Price.

“Per Share Merger Consideration Value” means (a) the Equity Value *divided by* (b) the total number of shares of Company Common Stock issued and outstanding as of immediately prior to the Effective Time, including (i) shares of Company Common Stock issued in connection with the Company Preferred Stock Conversion and the Company Convertible Note Conversion, and (ii) any shares of Company Common Stock issued or issuable upon the exercise of all Company Options.

“Permits” means all permits, licenses, certificates of authority, authorizations, approvals, registrations and other similar consents issued by or obtained from a Governmental Authority.

“Permitted Liens” means (i) statutory or common law Liens of mechanics, materialmen, warehousemen, landlords, carriers, repairmen, construction contractors and other similar Liens (A) that arise in the ordinary course of business, (B) that relate to amounts not yet delinquent or (C) that are being contested in good faith through appropriate Actions, and either are not material or appropriate reserves for the amount being contested have been established in accordance with GAAP, (ii) Liens arising under original purchase price conditional sales contracts and equipment leases with third parties entered into in the ordinary course of business, (iii) Liens for Taxes not yet delinquent or that are being contested in good faith through appropriate Actions to the extent appropriate reserves have been established in accordance with GAAP, (iv) non-monetary

Liens, encumbrances and restrictions on real property (including easements, covenants, rights of way and similar restrictions of record) that do not materially interfere with the present uses of such real property, (v) non-exclusive licenses of Owned Intellectual Property entered into in the ordinary course of business, (vi) Liens that secure obligations that are reflected as liabilities on the balance sheet included in the Unaudited Financial Statements or Liens the existence of which is referred to in the notes to the balance sheet included in the Unaudited Financial Statements, (vii) in the case of Leased Real Property, matters that would be disclosed by an accurate survey or inspection of such Leased Real Property, which do not materially interfere with the current use or occupancy of any Leased Real Property, (viii) requirements and restrictions of zoning, building and other applicable Laws and municipal by-laws, and development, site plan, subdivision or other agreements with municipalities, which do not materially interfere with the current use or occupancy of any Leased Real Property, (ix) statutory Liens of landlords for amounts that (A) are not due and payable, (B) are being contested in good faith by appropriate proceedings and either are not material or appropriate reserves for the amount being contested have been established in accordance with GAAP or (C) may thereafter be paid without penalty and (x) Liens described on [Schedule 1.01\(b\)](#) or incurred in connection with activities permitted under [Section 6.01](#) hereof (including, for the avoidance of doubt, any refinancings of existing indebtedness of the Company).

“[Person](#)” means any individual, firm, corporation, partnership (limited or general), limited liability company, incorporated or unincorporated association, joint venture, joint stock company, governmental agency or instrumentality or other entity of any kind.

“[Personal Information](#)” means any personal information that specifically identifies, is reasonably capable of being associated with, or could reasonably be linked, directly or indirectly, any particular individual or household.

“[Privacy and Security Requirements](#)” means, to the extent applicable to the Company, (a) any Laws relating to privacy and data security, including laws regulating the Processing of Protected Data; (b) the Payment Card Industry Data Security Standard issued by the PCI Security Standards Council, as it may be amended from time to time (“[PCI DSS](#)”); (c) all Contracts between the Company and any Person that is applicable to the PCI DSS, privacy, data security and/or the Processing of Protected Data; (d) all policies and procedures applicable to the Company relating to the PCI DSS, privacy, data security and/or the Processing of Protected Data, including without limitation all website and mobile application privacy policies and internal information security procedures ; and (e) National Institute of Standards and Technology (NIST) 800-181 Workforce Framework for Cybersecurity (NICE Framework).

“[Pro Rata Basis](#)” has the meaning specified in [Section 3.06\(e\)](#).

“[Processing](#)” means the creation, collection, use (including, without limitation, for the purposes of sending telephone calls, text messages and emails), storage, maintenance, processing, recording, distribution, transfer, transmission, receipt, import, export, protection, safeguarding, access, disposal or disclosure or other activity regarding data (whether electronically or in any other form or medium).

“[Proposals](#)” has the meaning specified in [Section 8.03\(c\)](#).

“[Protected Data](#)” means Personal Information and Confidential Data.

“[Proxy Statement](#)” means the proxy statement filed by Acquiror as part of the Registration Statement with respect to the Special Meeting for the purpose of soliciting proxies from Acquiror Stockholders to approve the Proposals (which shall also provide the Acquiror Stockholders with the opportunity to redeem their shares of Acquiror Common Stock in conjunction with a stockholder vote on the Business Combination).

“[PubCo](#)” has the meaning specified in the recitals hereto.

“[PubCo Board](#)” means the board of directors of PubCo.

“[PubCo Bylaws](#)” has the meaning specified in the recitals hereto.

“[PubCo Charter](#)” has the meaning specified in the recitals hereto.

[Table of Contents](#)

“PubCo Option” has the meaning specified in Section 3.05(a).

“PubCo’s Common Stock” means PubCo’s Common Stock, par value \$0.0001 per share, entitling the holder of each such share to 1 vote per share.

“Real Estate Lease Documents” has the meaning specified in Section 4.18(b).

“Redeeming Stockholder” means an Acquiror Stockholder who demands that Acquiror redeem its Acquiror Common Stock for cash in connection with the Offer and in accordance with the Acquiror Organizational Documents.

“Registered Intellectual Property” has the meaning specified in Section 4.11(a).

“Registration Rights Agreement” has the meaning specified in the recitals hereto, and is in the form of Exhibit I hereto.

“Registration Statement” has the meaning specified in Section 8.03(a).

“Regulatory Consent Authorities” means the Antitrust Division of the United States Department of Justice or the United States Federal Trade Commission, as applicable.

“Release Notice” has the meaning specified in Section 3.06(b)(ii).

“Representative” means, as to any Person, any of the officers, directors, managers, employees, agents, counsel, accountants, financial advisors, lenders, debt financing sources and consultants of such Person.

“Retained Agents” has the meaning specified in Section 11.16(a).

“Schedules” means the Acquiror and Merger Sub Schedules and the Company Schedules.

“SEC” means the United States Securities and Exchange Commission.

“Securities Act” means the Securities Act of 1933.

“Securities Laws” means the securities laws of any state, federal or foreign entity and the rules and regulations promulgated thereunder.

“Series A Preferred Stock” has the meaning specified in Section 4.06(a).

“Series B Preferred Stock” has the meaning specified in Section 4.06(a).

“Software” means any and all (a) computer programs, including any and all software implementation of algorithms, models and methodologies, whether in source code, object code, human readable form or other form, (b) databases and compilations, including any and all data and collections of data, whether machine readable or otherwise, (c) descriptions, flow charts and other documentation used to design, plan, organize and develop any of the foregoing, screens, user interfaces, report formats, firmware, development tools, templates, menus, buttons and icons and (d) all documentation including user manuals and other training documentation relating to any of the foregoing.

“Special Meeting” means a meeting of the holders of Acquiror Common Stock to be held for the purpose of approving the Proposals.

“Sponsor” means, individually, CleanTech Sponsor I LLC, a Delaware limited liability company or CleanTech Investments, LLC, a Delaware limited liability company, and collectively, both of the foregoing.

“Stock Issuance Proposal” has the meaning specified in Section 8.03(c).

“Stockholder Action” has the meaning specified in Section 7.09.

“Stockholder Earnout Group” has the meaning specified in Section 3.06(a).

“Stockholder Representative” has the meaning specified in Section 11.16(a).

“Stock Power” has the meaning specified in Section 3.03(a).

[Table of Contents](#)

“Subscription Agreement” means an agreement executed by an Equity Investor pursuant to which such Equity Investor has committed to invest cash in Acquiror in order to acquire Acquiror Common Stock prior to or in connection with the Closing.

“Subsidiary” means, with respect to a Person, any corporation or other organization (including a limited liability company or a general or limited partnership), whether incorporated or unincorporated, of which such Person directly or indirectly owns or controls a majority of the securities or other interests having by their terms ordinary voting power to elect a majority of the board of directors or others performing similar functions with respect to such corporation or other organization or any organization of which such Person or any of its Subsidiaries is, directly or indirectly, a general partner or managing member.

“Substitute Awards” has the meaning specified in [Section 3.05\(b\)](#).

“Surviving Company” has the meaning specified in [Section 2.01](#).

“Surviving Company Bylaws” means the form of bylaws set forth on [Exhibit D](#).

“Surviving Company Charter” means the form of amended and restated certificate of incorporation set forth on [Exhibit E](#).

“Surviving Provisions” has the meaning specified in [Section 10.02](#).

“TBOC” has the meaning specified in the recitals hereto.

“Tax” means any federal, state, provincial, territorial, local, foreign and other net income, alternative or add-on minimum, franchise, gross income, adjusted gross income or gross receipts, employment, withholding, payroll, ad valorem, transfer, franchise, license, excise, severance, stamp, occupation, premium, personal property, real property, capital stock, profits, disability, registration, value added, estimated, customs duties, escheat, sales, use, or other tax, governmental fee or other like assessment, together with any interest, penalty, addition to tax or additional amount imposed with respect thereto by a Governmental Authority.

“Tax Return” means any return, report, statement, refund, claim, declaration, information return, statement, estimate or other document filed or required to be filed with a Governmental Authority respect to Taxes, including any schedule or attachment thereto and including any amendments thereof.

“Terminating Acquiror Breach” has the meaning specified in [Section 10.01\(c\)](#).

“Terminating Company Breach” has the meaning specified in [Section 10.01\(b\)](#).

“Termination Date” has the meaning specified in [Section 10.01\(b\)](#).

“Transaction Finance Loans” has the meaning specified in the recitals hereto.

“Transaction Proposal” has the meaning specified in [Section 8.03\(c\)](#).

“Transactions” means the transactions contemplated by this Agreement to occur at or prior to the Closing on the Closing Date, including the Merger.

“Treasury Regulations” means the regulations promulgated under the Code.

“Trust Account” has the meaning specified in [Section 5.08\(a\)](#).

“Trust Agreement” has the meaning specified in [Section 5.08\(a\)](#).

“Trustee” has the meaning specified in [Section 5.08\(a\)](#).

“Unaudited Financial Statements” has the meaning specified in [Section 4.07](#).

“Unit Separation” means, the election of any holder of an Acquiror Unit, to separate such Acquiror Unit into Acquiror Common Stock, Acquiror Rights, and Acquiror Public Warrants.

“VWAP” means, for any security as of any date(s), the dollar volume-weighted average price for such security on the principal securities exchange or securities market on which such security is then traded during the period beginning at 9:30:01 a.m., New York time, and ending at 4:00:00 p.m., New York time, as reported by Bloomberg through its “HP” function (set to weighted average) or, if the foregoing does not apply, the dollar volume-weighted average price of such security in the over-the-counter market on the electronic bulletin board for such security during the period beginning at 9:30:01 a.m., New York time, and ending at 4:00:00 p.m., New York time, as reported by Bloomberg, or, if no dollar volume-weighted average price is reported for such security by Bloomberg for such hours, the average of the highest closing bid price and the lowest closing ask price of any of the market makers for such security as reported by OTC Markets Group Inc. If the VWAP cannot be calculated for such security on such date(s) on any of the foregoing bases, the VWAP of such security on such date(s) shall be the fair market value per share on such date(s) as reasonably determined by the Acquiror.

“Willful Breach” means, with respect to any agreement, a party’s knowing and intentional material breach of any of its representations or warranties as set forth in such agreement, or such party’s material breach of any of its covenants or other agreements set forth in such agreement, which material breach constitutes, or is a consequence of, a purposeful act or failure to act by such party with the knowledge that the taking of such act or failure to take such act would cause a material breach of such agreement.

“Working Capital Loans” means any loans provided by the Sponsor or its Affiliates to the SPAC for the sole purpose of funding working capital expenses incurred in good faith by the SPAC in the ordinary course of business, which loans shall bear interest at a rate not to exceed 2% per annum and shall not exceed in the aggregate \$1,000,000.

1.02 Construction.

(a) Unless the context of this Agreement otherwise requires, (i) words of any gender include each other gender, (ii) words using the singular or plural number also include the plural or singular number, respectively, (iii) the terms “hereof,” “herein,” “hereby,” “hereto” and derivative or similar words refer to this entire Agreement, (iv) the terms “Article,” “Section,” “Schedule,” “Exhibit” and “Annex” refer to the specified Article, Section, Schedule, Exhibit or Annex of or to this Agreement unless otherwise specified, (v) the word “including” shall mean “including without limitation” and (vi) the word “or” shall be disjunctive but not exclusive.

(b) When used herein, “ordinary course of business” means an action taken, or omitted to be taken, in the ordinary and usual course of the Company’s or the Acquiror’s business, as applicable, consistent with past practice (including, for the avoidance of doubt, recent past practice in light of COVID-19). Notwithstanding anything to the contrary contained in this Agreement, nothing herein shall prevent the Company from taking or failing to take any COVID-19 Actions and (x) no such COVID-19 Actions shall be deemed to violate or breach this Agreement in any way, (y) such COVID-19 Actions shall be deemed to constitute an action taken in the ordinary course and (z) no such COVID-19 Actions shall serve as a basis for Acquiror to terminate this Agreement or assert that any of the conditions to the Closing contained herein have not been satisfied, provided that such COVID-19 Actions do not disproportionately affect the Company as compared to other similarly situated companies that results in a Material Adverse Effect on the Company.

(c) Any reference in this Agreement to “Pubco” shall also mean Acquiror to the extent the matter relates to the pre-Closing period and any reference to “Acquiror” shall also mean “Pubco” to the extent the matter relates to the post-Closing period (including, for the purposes of this [Section 1.02\(c\)](#), the Effective Time).

(d) Unless the context of this Agreement otherwise requires, references to agreements and other documents shall be deemed to include all subsequent amendments and other modifications thereto.

(e) Unless the context of this Agreement otherwise requires, references to statutes shall include all regulations promulgated thereunder and references to statutes or regulations shall be construed as including all statutory and regulatory provisions consolidating, amending or replacing the statute or regulation.

(f) The language used in this Agreement shall be deemed to be the language chosen by the parties to express their mutual intent and no rule of strict construction shall be applied against any party.

[Table of Contents](#)

(g) Whenever this Agreement refers to a number of days, such number shall refer to calendar days unless Business Days are specified. If any action is to be taken or given on or by a particular calendar day, and such calendar day is not a Business Day, then such action may be deferred until the next Business Day.

(h) All accounting terms used herein and not expressly defined herein shall have the meanings given to them under GAAP.

(i) The phrases “delivered,” “provided to,” “furnished to,” “made available” and phrases of similar import when used herein, unless the context otherwise requires, means that a copy of the information or material referred to has been (A) provided no later than one calendar day prior to the date of this Agreement to the party to which such information or material is to be provided or furnished (i) in the virtual “data room” set up by the Company in connection with this Agreement or (ii) by delivery to such party or its legal counsel via electronic mail or hard copy form, or (B) with respect to Acquiror, filed with the SEC by Acquiror on or prior to the date hereof.

1.03 Knowledge. As used herein, the phrase “to the knowledge” shall mean the actual knowledge of, in the case of the Company, Founder and, in the case of Acquiror, Eli Spiro.

**ARTICLE II
THE MERGER; CLOSING**

2.01 The Merger. Upon the terms and subject to the conditions set forth in this Agreement, at the Effective Time, Merger Sub shall be merged with and into the Company (the “Merger”), with the Company being the surviving corporation (which is sometimes hereinafter referred to for the periods at and after the Effective Time as the “Surviving Company”) following the Merger and the separate corporate existence of Merger Sub shall cease. The Merger shall be consummated in accordance with this Agreement and the TBOC and evidenced by a certificate of merger between Merger Sub and the Company (the “Certificate of Merger”), such Merger to be consummated immediately upon filing of the Certificate of Merger or at such later time as may be agreed by Acquiror and the Company in writing and specified in the Certificate of Merger (the “Effective Time”).

2.02 Effects of the Merger. The Merger shall have the effects set forth in this Agreement and the TBOC. Without limiting the generality of the foregoing and subject thereto, by virtue of the Merger and without further act or deed, at the Effective Time, all of the property, rights, privileges, powers and franchises of the Company and Merger Sub shall vest in the Surviving Company and all of the debts, liabilities and duties of the Company and Merger Sub shall become the debts, liabilities and duties of the Surviving Company.

2.03 Closing. Subject to the terms and conditions of this Agreement, the closing of the Merger (the “Closing”) shall take place electronically through the exchange of documents via e-mail or facsimile on the date which is three (3) Business Days after the date on which all conditions set forth in Article IX shall have been satisfied or waived (other than those conditions that by their terms are to be satisfied at the Closing, but subject to the satisfaction or waiver thereof) or such other time and place as Acquiror and the Company may mutually agree in writing. The date on which the Closing actually occurs is referred to in this Agreement as the “Closing Date.” Subject to the satisfaction or waiver of all of the conditions set forth in Article IX of this Agreement, and provided this Agreement has not theretofore been terminated pursuant to its terms, on the Closing Date, the Company and Merger Sub shall cause the Certificate of Merger to be executed, acknowledged and filed with the Secretary of State of the State of Texas as provided in Subchapter A, Chapter 10, Title 1 of the TBOC.

2.04 Organizational Documents of Acquiror and the Surviving Company.

(a) At the Closing and immediately prior to the Effective Time, the Certificate of Incorporation and the bylaws of Acquiror shall be amended and restated in their entirety to be the PubCo Charter and the PubCo Bylaws, respectively, until thereafter supplemented or amended in accordance with their terms and the DGCL.

(b) At the Effective Time by virtue of the Merger, the Company Certificate of Incorporation and the bylaws of the Company, as in effect immediately prior to the Effective Time, shall be amended and restated in their entireties to be the Surviving Company Charter and the Surviving Company Bylaws, respectively, until thereafter supplemented or amended in accordance with their terms and the TBOC.

2.05 Directors and Officers of Acquiror and the Surviving Company.

(a) Except as otherwise directed in writing by the Company, and conditioned upon the occurrence of the Closing, subject to any limitation with respect to any specific individual imposed under applicable Laws and the listing requirements of Nasdaq (for the avoidance of doubt, after giving effect to any exemptions available to a controlled company), Acquiror shall take all actions necessary or appropriate (including securing resignations or removals and making such appointments as are necessary) to cause, effective as of the Closing, the PubCo Board to consist of the persons designated by the Company in writing prior to Closing (including the persons contemplated to be on the PubCo Board pursuant to the Director Nomination Agreement). On the Closing Date, Acquiror shall enter into customary indemnification agreements reasonably satisfactory to the Company with such individuals elected as members of the PubCo Board as of the Closing, which indemnification agreements shall continue to be effective immediately following the Closing.

(b) Except as otherwise directed in writing by the Company, and conditioned upon the occurrence of the Closing, Acquiror shall take all actions necessary or appropriate (including securing resignations or removals and making such appointments as are necessary) to cause the Persons constituting the officers of the Company prior to the Effective Time to be the officers of Acquiror (and holding the same titles as held at the Company) until the earlier of their resignation or removal or until their respective successors are duly appointed.

(c) The Company shall take all necessary action prior to the Effective Time such that (a) each director of the Company in office immediately prior to the Effective Time shall cease to be a director immediately following the Effective Time (including by causing each such director to tender an irrevocable resignation as a director, effective as of the Effective Time) and (b) certain directors or executive officers of the Company, determined by the Company and communicated in writing to Acquiror prior to the Closing Date, shall be appointed to the Board of Directors of the Surviving Company, effective as of immediately following the Effective Time, and, as of such time, shall be the only directors of the Surviving Company (including by causing the Company Board to adopt resolutions prior to the Effective Time that expand or decrease the size of the Company Board, as necessary, and appoint such persons to the vacancies resulting from the incumbent directors' respective resignations or, if applicable, the newly created directorships upon any expansion of the size of the Company Board). Each person appointed as a director of the Surviving Company pursuant to the preceding sentence shall remain in office as a director of the Surviving Company until his or her successor is elected and qualified or until his or her earlier resignation or removal.

(d) Except as otherwise directed in writing by the Company, the Persons constituting the officers of the Company prior to the Effective Time shall continue to be the officers of the Surviving Company (and holding the same titles as held at the Company) until the earlier of their resignation or removal or until their respective successors are duly appointed.

**ARTICLE III
EFFECTS OF THE MERGER**

3.01 Effect on Securities. Subject to the provisions of this Agreement:

(a) immediately prior to the Company Preferred Stock Conversion and prior to the Effective Time, each Company Convertible Note that is issued and outstanding immediately prior to such time shall automatically convert into several shares of Company Common Stock in accordance with the terms of such Company Convertible Note (collectively, the "Company Convertible Note Conversion"). Each Company Convertible Note converted into shares of Company Common Stock shall no longer be outstanding and shall cease to exist, and each holder of a Company Convertible Note shall thereafter cease to have any rights with respect to such securities;

(b) immediately prior to the Effective Time, each share of Company Preferred Stock that is issued and outstanding immediately prior to such time shall automatically convert into a number of shares of Company Common Stock in accordance with the Company Certificate of Incorporation (collectively, the "Company Preferred Stock Conversion"). All of the shares of Company Preferred Stock converted into shares of Company Common Stock shall no longer be outstanding and shall cease to exist, and each holder of Company Preferred Stock shall thereafter cease to have any rights with respect to such securities;

(c) at the Effective Time (and, for the avoidance of doubt, following the Company Convertible Note Conversion and the Company Preferred Stock Conversion), by virtue of the Merger and without any action on the part of any Company Stockholder, subject to and in consideration of the terms and conditions set forth herein

Table of Contents

(including without limitation delivery of the release contemplated by Section 3.04(a)(ii)), each share of Company Common Stock that is issued and outstanding immediately prior to the Effective Time (other than the Dissenting Shares), shall be converted into the right to receive the applicable Per Share Merger Consideration and the Earnout Shares. All of the shares of Company Common Stock converted into the right to receive consideration as described in this Section 3.01(c) shall no longer be outstanding and shall cease to exist, and each holder of Company Common Stock shall thereafter cease to have any rights with respect to such securities, except the right to receive the applicable consideration described in this Section 3.01(c) into which such share of Company Common Stock shall have been converted into in the Merger.

(d) at the Effective Time, by virtue of the Merger and without any action on the part of any holder thereof, each share of common stock, par value \$0.01 per share, of Merger Sub issued and outstanding immediately prior to the Effective Time shall no longer be outstanding and shall thereupon be converted into and become one validly issued fully paid and non-assessable share of common stock, par value \$0.01 per share, of the Surviving Company and all such shares shall constitute the only outstanding shares of capital stock of the Surviving Company as of immediately following the Effective Time; and

(e) at the Effective Time, by virtue of the Merger and without any action on the part of any holder thereof, each share of Company Capital Stock held in the treasury of the Company immediately prior to the Effective Time shall be cancelled and no payment or distribution shall be made with respect thereto.

3.02 Equitable Adjustments. If, between the date of this Agreement and the Closing, the outstanding shares of Company Common Stock, shares of Company Preferred Stock or shares of Acquiror Common Stock shall have been changed into a different number of shares or a different class, by reason of any stock dividend, subdivision, reclassification, reorganization, recapitalization, split, combination or exchange of shares, or any similar event shall have occurred, or if there shall have been any breach of Section 5.15(a) of this Agreement by Acquiror with respect to the number of its issued and outstanding shares of Acquiror Common Stock (or any other issued and outstanding equity security interests in Acquiror) or rights to acquire Acquiror Common Stock (or any other equity security interests in Acquiror), then any number, value (including dollar value) or amount contained herein which is based upon the number of shares of Company Common Stock, shares of Company Preferred Stock or shares of Acquiror Common Stock (or any other equity security interests in Acquiror), as applicable, will be appropriately adjusted to provide to the holders of Company Common Stock, the holders of shares of Company Preferred Stock or the holders of Acquiror Common Stock, as applicable, the same economic effect as contemplated by this Agreement prior to such event; provided, however, that this Section 3.02 shall not be construed to permit Acquiror, the Company or Merger Sub to take any action with respect to their respective securities that is prohibited by the terms and conditions of this Agreement.

3.03 Delivery of Merger Consideration

(a) Concurrently with the delivery of the Consent Solicitation Statement, Acquiror shall cause to be delivered to each holder of record of Company Convertible Notes, Company Common Stock and Company Preferred Stock at the address provided to Acquiror by the Company, a stock power (each a “Stock Power”) with respect to such Company Convertible Notes, Company Common Stock and Company Preferred Stock, as applicable.

(b) Upon the receipt of a Stock Power duly, completely and validly executed, and such other documents as may reasonably be required by Acquiror, the holder of such shares of Company Common Stock and Company Preferred Stock, as applicable, shall be entitled to receive in exchange therefor, and conditioned upon the occurrence of the Closing, the consideration described in Section 3.01(c) into which such Company Convertible Notes and shares of Company Common Stock and Company Preferred Stock, as applicable, have been converted pursuant to Section 3.01(c) (after giving effect to Sections 3.01(a) and 3.01(b)). Until delivery of Stock Power as contemplated by this Section 3.03(b), each Company Convertible Note and share of Company Common Stock and Company Preferred Stock shall be deemed at any time from and after the Effective Time to represent only the right to receive upon delivery of Stock Power the consideration described in Section 3.01(c) which the holders of Company Convertible Notes and shares of Company Common Stock and Company Preferred Stock, as applicable, were entitled to receive in respect of such shares pursuant to this Section 3.03(b).

3.04 Uncertificated Securities. The Company and the Acquiror each agree and acknowledge that the securities of the Company are not certificated, and no Company Stockholder shall be required to surrender any stock certificate in order to receive the Per Share Merger Consideration contemplated in Section 3.01(c).

3.05 Treatment of Company Options.

(a) Effective as of the Effective Time, each option to purchase shares of the Company Common Stock (a “Company Option”) granted under any Company Stock Plan that is outstanding and unexercised immediately prior to the Effective Time, whether or not then vested or exercisable, shall be assumed by the PubCo and shall be converted into a stock option (a “PubCo Option”) to acquire shares of PubCo’s Common Stock in accordance with this Section 3.05(a). Each such PubCo Option as so assumed and converted shall continue to have, and shall be subject to, the same terms and conditions as applied to the Company Option immediately prior to the Effective Time (but taking into account any changes thereto provided for in the applicable Company Stock Plan, in any award agreement or in such Company Option by reason of this Agreement or the Transactions). As of the Effective Time, each such PubCo Option as so assumed and converted shall be for that number of shares of PubCo’s Common Stock determined by multiplying the number of shares of the Company Common Stock subject to such Company Option immediately prior to the Effective Time by the Exchange Ratio, which product shall be rounded down to the nearest whole number of shares, at a per share exercise price determined by dividing the per share exercise price of such Company Option immediately prior to the Effective Time by the Exchange Ratio, which quotient shall be rounded down to the nearest whole cent. The Company shall terminate the Company Stock Plan as of the Effective Time. As of the Effective Time, all Company Options shall no longer be outstanding and each holder of PubCo Options shall cease to have any rights with respect to such Company Options, except as set forth in this Section 3.05(a).

(b) Notwithstanding the foregoing, the conversions described in this Section 3.05 will be subject to such modifications, if any, as are required to cause the conversion to be made in a manner consistent with the requirements of Treasury Regulation Section 1.409A-1(b)(5)(v)(D). Following the Effective Time, each PubCo Option shall be subject to the Acquiror Incentive Plan (and considered “Substitute Awards” for purposes thereof) and to the same terms and conditions, including, without limitation, any vesting conditions, as had applied to the corresponding Company Option as of immediately prior to the Effective Time, except for such terms rendered inoperative by reason of the Transactions, subject to such adjustments as reasonably determined by the PubCo Board to be necessary or appropriate to give effect to the conversion or the Transactions.

3.06 Earnout.

(a) *Delivery of the Earnout Shares.* At the Closing and immediately prior to the Effective Time, PubCo shall issue electronically through The Depository Trust Company (“DTC”), using DTC’s Deposit/Withdrawal At Custodian System, to the Company Stockholders who have received shares of PubCo’s Common Stock pursuant to Section 3.01(d) (the “Stockholder Earnout Group”) and the Stockholder Earnout Group will deliver to the Earnout Escrow Agent (as defined below), Seven Million Five Hundred Thousand (7,500,000) shares (as such shares may be adjusted for any stock split, reverse stock split, recapitalization, reclassification, reorganization, exchange, subdivision or combination (the “Earnout Shares”), which shares shall be released, if at all, on a Pro Rata Basis, among the Stockholder Earnout Group in accordance with the terms and conditions of this Section 3.06. The parties agree that the Stockholder Earnout Group shall be treated, on a Pro Rata Basis, as the owners of the Earnout Shares for so long as they are in the Earnout Escrow Account for income Tax purposes, and shall file all Tax Returns consistent with such treatment. Effective as of the Closing, the Stockholder Earnout Group shall have the right to vote, on a Pro Rata Basis, each of the Earnout Shares until such Earnout Shares are forfeited as if the Stockholder Earnout Group was the owner of record of such Earnout Shares. Until Earnout Shares have been released or been forfeited hereunder, an amount equal to any dividends or distributions that would have been payable to the Stockholder Earnout Group if the Earnout Shares had been released prior to the record date for such dividends or distributions shall be delivered by Pubco to the Earnout Escrow Agent for the benefit of the Stockholder Earnout Group with respect to the Earnout Shares (the “Withholding Amount”). If any securities of Pubco or any other Person are included in the Withholding Amount, then any dividends or distributions in respect of or in exchange for any of such securities in the Withholding Amount, whether by way of stock splits or otherwise, shall be delivered to the Earnout Escrow Agent and included in the “Withholding Amount”, and will be released to the Stockholder Earnout Group upon the release of the corresponding securities. If and when the Earnout Shares are released in accordance with this Section 3.06, the Earnout Escrow Agent shall release to each member of the Stockholder Earnout Group, on a Pro Rata Basis, the aggregate amount of the Withholding Amount attributable to such Earnout Shares that have been released and, if applicable, shall continue to withhold any remaining Withholding Amount that is attributable to such Earnout Shares that have not yet been released until such Earnout Shares are released, in which case such remaining Withholding Amount shall be released to the Stockholder Earnout Group. If all or any portion of the Earnout Shares are forfeited to Pubco in accordance

with this [Section 3.06](#), then the portion of the Withholding Amount attributable to the portion of the Earnout Shares that have been forfeited to Pubco shall be automatically forfeited to Pubco without consideration and with no further action required of any person.

(b) *Procedures Applicable to the Earnout of the Earnout Shares.*

(i) Upon receipt of the Earnout Shares, an escrow agent (the “[Earnout Escrow Agent](#)”) will place such Earnout Shares in an escrow account (the “[Earnout Escrow Account](#)”) established pursuant to an escrow agreement in the form attached hereto as [Exhibit F](#), to be entered into at the Closing by Acquiror, the Sponsor, the Stockholder Representative and the Earnout Escrow Agent (the “[Earnout Escrow Agreement](#)”).

(ii) Promptly upon the occurrence of any triggering event described in [Section 3.06\(c\)](#) below, PubCo and Stockholder Representative shall prepare and deliver, or cause to be prepared and delivered, a joint written share release instruction to the Earnout Escrow Agent (a “[Release Notice](#)”), which Release Notice shall set forth in reasonable detail the triggering event giving rise to the requested release and the specific release instructions with respect thereto (including the number of Earnout Shares to be released and the identity of the person to whom they should be released).

(iii) The Earnout Shares that are to be released from the Earnout Escrow Account and distributed to each member of the Stockholder Earnout Group shall be distributed to each member of the Stockholder Earnout Group on a Pro Rata Basis.

(iv) For the avoidance of doubt, any Earnout Shares to be released and distributed pursuant to this [Section 3.06](#) to Company Stockholders shall be distributed and released as PubCo’s Common Stock.

(c) *Release of Earnout Shares.* The Earnout Shares shall be released and delivered as follows:

(i) one-half of the Earnout Shares will be released from the Earnout Escrow Account, and distributed to each member of the Stockholder Earnout Group on a Pro Rata Basis in accordance with [Section 3.06\(b\)\(ii\)](#) upon receipt of the applicable Release Notice by the Earnout Escrow Agent, if, on or prior to the fifth (5th) anniversary of the Closing Date: (x) the VWAP of shares of PubCo’s Common Stock equals or exceeds \$15.00 per share for twenty (20) of any thirty (30) consecutive trading days commencing after the Closing on Nasdaq, or (y) if PubCo consummates a transaction which results in the stockholders of PubCo having the right to exchange their shares for cash, securities or other property having a value equaling or exceeding \$15.00 per share (for any non-cash proceeds, as determined based on the agreed valuation set forth in the applicable definitive agreements for such transaction or, in the absence of such valuation, as determined in good faith by the PubCo Board);

(ii) one-quarter of the Earnout Shares will be released from the Earnout Escrow Account, and distributed to each member of the Stockholder Earnout Group on a Pro Rata Basis in accordance with [Section 3.06\(b\)\(ii\)](#) upon receipt of the applicable Release Notice by the Earnout Escrow Agent, if, on or prior to the fifth (5th) anniversary of the Closing Date: (x) the VWAP of shares of PubCo’s Common Stock equals or exceeds \$17.50 per share for twenty (20) of any thirty (30) consecutive trading days commencing after the Closing on Nasdaq, or (y) if PubCo consummates a transaction which results in the stockholders of PubCo having the right to exchange their shares for cash, securities or other property having a value equaling or exceeding \$17.50 per share (for any non-cash proceeds, as determined based on the agreed valuation set forth in the applicable definitive agreements for such transaction or, in the absence of such valuation, as determined in good faith by PubCo Board);

(iii) one-quarter of the Earnout Shares will be released from the Earnout Escrow Account, and distributed to each member of the Stockholder Earnout Group on a Pro Rata Basis in accordance with [Section 3.06\(b\)\(ii\)](#) upon receipt of the applicable Release Notice by the Earnout Escrow Agent, if, on or prior to the fifth (5th) anniversary of the Closing Date: (x) the VWAP of shares of PubCo’s Common Stock equals or exceeds \$20.00 per share for twenty (20) of any thirty (30) consecutive trading days commencing after the Closing on Nasdaq; provided, the last qualifying trading day constituting the triggering event hereunder must occur on or after December 31, 2022; or (y) if PubCo consummates a transaction which results in the stockholders of PubCo having the right to exchange their shares

Table of Contents

for cash, securities or other property having a value equaling or exceeding \$20.00 per share (for any non-cash proceeds, as determined based on the agreed valuation set forth in the applicable definitive agreements for such transaction or, in the absence of such valuation, as determined in good faith by PubCo Board); and

(iv) if the conditions set forth in either Section 3.06(c)(i) or (ii) have not been satisfied following the fifth (5th) anniversary of the Closing Date, any Earnout Shares remaining in the Earnout Escrow Account shall be automatically released to PubCo for cancellation and the members of the Stockholder Earnout Group shall not have any right to receive such Earnout Shares or any benefit therefrom.

(d) The number of shares of PubCo's Common Stock to be issued and released pursuant to Section 3.06(a), Section 3.06(b) and Section 3.06(c) and the VWAP price per share triggering events set forth in Section 3.06(c), shall be equitably adjusted for any stock dividend, subdivision, reclassification, recapitalization, split, combination or exchange of shares, or any similar event affecting the Acquiror Common Stock after the date of this Agreement.

(e) As used in this Section 3.06, the term "Pro Rata Basis" shall mean, with respect to any member of the Stockholder Earnout Group, in accordance with the ratio calculated by dividing (x) the sum of the number of shares of PubCo's Common Stock held by such member of the Stockholder Earnout Group by (y) the sum of the aggregate number of shares of PubCo's Common Stock held by all of the members of the Stockholder Earnout Group, in each case, as of immediately following the Closing.

(f) The issuance of Earnout Shares shall be treated as an adjustment to the merger consideration by the parties for Tax purposes, unless otherwise required by applicable Law.

3.07 Withholding. Each of Acquiror, Merger Sub, the Company, the Surviving Company and their respective Affiliates shall be entitled to deduct and withhold from any amounts otherwise deliverable or payable under this Agreement such amounts that any such Persons are required to deduct and withhold with respect to any of the deliveries and payments contemplated by this Agreement under the Code or any other applicable Law; provided that before making any deduction or withholding pursuant to this Section 3.07 other than with respect to compensatory payments made pursuant to this Agreement, Acquiror shall use commercially reasonable efforts to give the Company at least five days prior written notice of any anticipated deduction or withholding (together with any legal basis therefor) to provide the Company with sufficient opportunity to provide any forms or other documentation from the applicable equity holders or take such other steps in order to avoid such deduction or withholding and shall reasonably consult and cooperate with the Company in good faith to attempt to reduce or eliminate any amounts that would otherwise be deducted or withheld pursuant to this Section 3.07. To the extent that Acquiror, Merger Sub, the Company, the Surviving Company or any of their respective Affiliates withholds such amounts with respect to any Person and properly remits such withheld amounts to the applicable Governmental Authority, such withheld amounts shall be treated as having been paid to or on behalf of such Person for all purposes. In the case of any such payment payable to employees of the Company or its Affiliates in connection with the Merger treated as compensation, the parties shall cooperate to pay such amounts through the Company's payroll to facilitate applicable withholding.

3.08 No Fractional Shares. Notwithstanding anything to the contrary contained herein, no fractional shares of PubCo's Common Stock or certificates or scripts representing such fractional shares shall be issued upon the conversion of Company Common Stock pursuant to Section 3.01(d), and any such fractional shares or interests therein shall not entitle the owner thereof to vote or to any other rights of a holder of PubCo's Common Stock. In lieu of the issuance of any such fractional share, each Person who would otherwise be entitled to a fraction of PubCo Common Stock (after aggregating all fractional shares of PubCo Common Stock that otherwise would be received by such Person) shall have the number of PubCo Common Stock issued to such Person rounded up in the aggregate to the nearest whole number of shares of PubCo Common Stock.

3.09 Payment of Expenses.

(a) No sooner than five or later than two Business Days prior to the Closing Date, the Company shall provide to Acquiror a written report setting forth a list of the following fees and expenses incurred by or on behalf of the Company or the Company Stockholders in connection with the conduct of the Company's sale process (including the evaluation and negotiation of business combinations with other third parties) and preparation, negotiation and execution of this Agreement and the consummation of the Transactions (together with written invoices and wire

transfer instructions for the payment thereof), solely to the extent such fees and expenses are incurred and expected to remain unpaid as of the close of business on the Business Day immediately preceding the Closing Date: (i) the fees and disbursements of outside counsel to the Company or the Company Stockholders incurred in connection with the Transactions and (ii) the fees and expenses of any other agents, advisors, consultants, experts and financial advisors employed by the Company in connection with the Transactions (collectively, the “Outstanding Company Expenses”). On the Closing Date following the Closing, Acquiror shall pay or cause to be paid by wire transfer of immediately available funds all such Outstanding Company Expenses.

(b) No sooner than five or later than two Business Days prior to the Closing Date, Acquiror shall provide to the Company a written report setting forth a list of all unpaid fees and disbursements of Acquiror, Merger Sub or the Sponsor for outside counsel and fees and expenses of Acquiror, Merger Sub or the Sponsor or for any other agents, advisors, consultants, experts and financial advisors employed by or on behalf of Acquiror, Merger Sub or the Sponsor in connection with Acquiror’s initial public offering (including any deferred underwriter fees), the Transactions or other proposed business combination with other third parties (together with written invoices and wire transfer instructions for the payment thereof) (collectively, the “Outstanding Acquiror Expenses”). On the Closing Date, Acquiror shall pay or cause to be paid by wire transfer of immediately available funds all such Outstanding Acquiror Expenses.

3.10 Dissenting Shares. Notwithstanding anything in this Agreement to the contrary, shares of Company Common Stock outstanding immediately prior to the Effective Time and owned by a holder who is entitled to demand and has properly demanded appraisal of such shares in accordance with, and who complies in all respects with, Section 10.354 of the TBOC (such shares, “Dissenting Shares”) shall not be converted into the right to receive the Per Share Merger Consideration, and shall instead represent the right to receive payment of the fair value of such Dissenting Shares in accordance with and to the extent provided by Section 10.354 of the TBOC. At the Effective Time, (a) all Dissenting Shares shall be cancelled, extinguished and cease to exist and (b) the holders of Dissenting Shares shall be entitled only to such rights as may be granted to them under the TBOC. If any such holder fails to perfect or otherwise waives, withdraws or loses such holder’s right to appraisal under Section 10.354 of the TBOC or other applicable Law, then the right of such holder to be paid the fair value of such Dissenting Shares shall cease and such Dissenting Shares shall be deemed to have been converted, as of the Effective Time, into the right to receive the Per Share Merger Consideration upon the terms and conditions set forth in this Agreement. The Company shall give Acquiror prompt notice (and in any event within two Business Days) of any demands received by the Company for appraisal of shares of Company Common Stock, attempted withdrawals of such demands and any other instruments served pursuant to the TBOC and received by the Company relating to rights to be paid the fair value of Dissenting Shares, and Acquiror shall have the right to participate in and, following the Effective Time, direct all negotiations and proceedings with respect to such demands. Prior to the Effective Time, the Company shall not, except with the prior written consent of Acquiror, make any payment with respect to, or settle or compromise or offer to settle or compromise, any such demands or waive any failure to timely deliver a written demand for appraisal or otherwise comply with the provisions under Section 10.354 of the TBOC, or agree or commit to do any of the foregoing.

ARTICLE IV REPRESENTATIONS AND WARRANTIES OF THE COMPANY

Except as set forth in the Company Schedules to this Agreement (each of which qualifies (a) the correspondingly numbered representation, warranty or covenant, and (b) such other representations, warranties or covenants where its relevance as an exception to (or disclosure for purposes of) such other representation, warranty or covenant is reasonably apparent), the Company represents and warrants to Acquiror and Merger Sub as follows:

4.01 Corporate Organization of the Company.

(a) The Company has been duly incorporated, is validly existing and in good standing under the Laws of the State of Texas and has the requisite corporate entity power and authority to own, lease and operate its assets and properties and to conduct its business as it is now being conducted. The Company Certificate of Incorporation and bylaws of the Company previously made available by the Company to Acquiror are true, correct and complete and are in effect as of the date of this Agreement.

[Table of Contents](#)

(b) As listed on Schedule 4.01, the Company is licensed or duly qualified and in good standing as a foreign company in each jurisdiction in which the ownership of its property or the character of its activities is such as to require it to be so licensed or qualified or in good standing, except where the failure to be so licensed or qualified has not had and would not, individually or in the aggregate, reasonably be expected to have a Material Adverse Effect.

4.02 No Subsidiaries. The Company does not have any Subsidiaries.

4.03 Due Authorization. The Company has all requisite company power and authority to execute and deliver this Agreement and each Ancillary Agreement to this Agreement to which it is a party and (subject to the approvals described in [Section 4.05](#) and the adoption of this Agreement and approval of the Merger by holders of (i) a majority of the voting power of the outstanding shares of Company Common Stock and (ii) seventy-five percent (75%) of the then outstanding shares of Company Preferred Stock (the "Company Requisite Approval") to perform its obligations hereunder and thereunder and to consummate the transactions contemplated hereby and thereby. The execution, delivery and performance of this Agreement and such Ancillary Agreements and the consummation of the transactions contemplated hereby and thereby have been duly and validly authorized and approved by the Company Board and upon receipt of the Company Requisite Approval, no other company proceeding on the part of the Company is necessary to authorize this Agreement or such Ancillary Agreements or the Company's performance hereunder or thereunder. This Agreement has been, and each such Ancillary Agreement will be, duly and validly executed and delivered by the Company and, assuming due authorization and execution by each other party hereto and thereto, constitutes, or will constitute, as applicable, a legal, valid and binding obligation of the Company, enforceable against the Company in accordance with its terms, subject to applicable bankruptcy, insolvency, fraudulent conveyance, reorganization, moratorium and similar Laws affecting creditors' rights generally and subject, as to enforceability, to general principles of equity. The Company Requisite Approval is the only vote of the holders of any class or series of capital stock of the Company required to approve and adopt this Agreement and approve the transactions contemplated hereby.

4.04 No Conflict. Subject to the receipt of the consents, approvals, authorizations and other requirements set forth in [Section 4.05](#) or on [Schedule 4.05](#), the execution, delivery and performance of this Agreement and each Ancillary Agreement to this Agreement to which it is a party by the Company and the consummation of the transactions contemplated hereby do not and will not (a) conflict with or violate any provision of, or result in the breach of, the certificate of formation, bylaws or other organizational documents of the Company, (b) conflict with or result in any violation of any provision of any Law, Permit or Governmental Order applicable to the Company, or any of their respective properties or assets, (c) violate, conflict with, result in a breach of any provision of or the loss of any benefit under, constitute a default (or an event which, with notice or lapse of time, or both, would constitute a default) under, or result in the termination or acceleration of, or a right of termination, cancellation, modification, acceleration or amendment under, accelerate the performance required by, or result in the acceleration or trigger of any payment, posting of collateral (or right to require the posting of collateral), time of payment, vesting or increase in the amount of any compensation or benefit payable pursuant to, any of the terms, conditions or provisions of any Contract of the type required to be disclosed in [Section 4.12\(a\)](#), or any Leased Real Property document to which the Company is a party or by which any of them or any of their respective assets or properties may be bound or affected or (d) result in the creation of any Lien upon any of the properties, equity interests or assets of the Company, except (in the case of clauses (b), (c) or (d) above) for such violations, conflicts, breaches or defaults which would not, individually or in the aggregate, reasonably be expected to have a Material Adverse Effect.

4.05 Governmental Authorities; Consents. Assuming the truth and completeness of the representations and warranties of the Acquiror contained in this Agreement, no consent, approval or authorization of, or designation, declaration or filing with, any Governmental Authority or notice, approval, consent waiver or authorization from any Governmental Authority is required on the part of the Company with respect to the Company's execution, delivery or performance of this Agreement or the consummation of the transactions contemplated hereby, except for (a) applicable requirements of the HSR Act and any other applicable Antitrust Law, (b) the filing of the Certificate of Merger in accordance with the TBOC, (c) any consents, approvals, authorizations, designations, declarations, waivers or filings, the absence of which would not, individually or in the aggregate, reasonably be expected to have a material adverse effect on the ability of the Company to consummate the Transactions, and (d) as otherwise disclosed on [Schedule 4.05](#).

4.06 Capitalization.

(a) As of the date hereof, the authorized capital stock of the Company is 11,060,226 shares of capital stock consisting of: (i) 10,000,000 shares of Common Stock, par value \$0.01 per share (the "Company Common Stock") and (ii) 1,060,226 shares of preferred stock, \$0.01 per share (the "Company Preferred Stock"), of which

[Table of Contents](#)

(1) 334,800 shares are designated as Series A Preferred Stock (the “Series A Preferred Stock”) and (2) 725,426 shares are designated as Series B Preferred Stock (the “Series B Preferred Stock”). As of December __, 2021, there were: (a) 678,400 shares of Company Common Stock issued and outstanding; (b) 334,800 shares of Series A Preferred issued and outstanding; and (c) 725,426 shares Series B Preferred issued and outstanding.

(b) All of the issued and outstanding shares of Company Common Stock and Company Preferred Stock (i) have been duly authorized and validly issued and are fully paid and nonassessable, (ii) were issued in compliance in all material respects with applicable Securities Law, (iii) were not issued in breach or violation of any preemptive rights or Contract, and (iv) except as set forth on Schedule 4.06(b), are fully vested. Set forth on Schedule 4.06(b) is a true, correct and complete list of each holder of shares of Company Common Stock, Company Preferred Stock or other equity interests of the Company (other than Company Options) and the number of shares of Company Common Stock, Company Preferred Stock or other equity interests held by each such holder as of December __, 2021. Except as set forth in this Section 4.06 or on Schedule 4.06(b) or pursuant to the Company Stock Plan, as of December __, 2021, there are no other shares of Company Common Stock, Company Preferred Stock or other equity interests of the Company authorized, reserved, issued or outstanding.

(c) Except for (i) Company Options granted pursuant to the Company Stock Plan, (ii) the Company Preferred Stock and (iii) the Company Convertible Notes as set forth on Schedule 4.06(c), as of the date hereof there are (x) no subscriptions, calls, options, warrants, rights or other securities convertible into or exchangeable or exercisable for shares of Company Common Stock or the equity interests of the Company, or any other Contracts to which the Company is a party or by which the Company is bound obligating the Company to issue or sell any shares of capital stock of, other equity interests in or debt securities of, the Company and (y) no equity equivalents, stock appreciation rights, phantom stock ownership interests or similar rights in the Company. As of the date hereof, except as set forth on Schedule 4.06(c) there are no outstanding contractual obligations of the Company to repurchase, redeem or otherwise acquire any securities or equity interests of the Company. Except as set forth on Schedule 4.06(c), there are no outstanding bonds, debentures, notes or other indebtedness of the Company having the right to vote (or convertible into, or exchangeable for, securities having the right to vote) on any matter for which the Company’s stockholders may vote. Except as set forth on Schedule 4.06(c), as of the date hereof the Company is not party to any shareholders’ agreement, voting agreement or registration rights agreement relating to its equity interests. With respect to each Company Option and Company Convertible Note, Schedule 4.06(c) sets forth, as of December __, 2021, the name of the holder of such Company Option or Company Convertible Note, the number of vested and unvested shares or common stock equivalent covered by such Company Option or Company Convertible Note, the date of grant and the cash exercise price, strike price or offset amount per share/unit of such Company Option or current outstanding balance under such Company Convertible Note. The Company has made available to Acquiror true and complete copy of the form of agreement evidencing each Company Option and Company Convertible Note, and has also delivered any other warrant agreements to the extent there are variations from the form of agreement, specifically identifying the Person(s) to whom such variant forms apply. The Company has made available to Acquiror a true and complete copy of the Company Stock Plan and form of agreement evidencing each Company Option, and has also delivered any other option agreements and restricted share agreements to the extent there are variations from the form of agreement, specifically identifying the Person(s) to whom such variant forms apply. Each Company Option (A) was granted, in all material respects, in compliance with all applicable Laws and all of the terms and conditions of the Company Stock Plan pursuant to which it was issued, (B) has an exercise price per Share equal to or greater than the fair market value of a Share at the close of business on the date of such grant, (C) has a grant date identical to the date on which the Company’s Board or compensation committee actually awarded such Company Option, (D) qualifies for the tax and accounting treatment afforded to such Company Option in the Company’s tax returns and the Company’s financial statements, respectively, and (E) does not trigger any liability for the holder thereof under Section 409A of the Code.

4.07 Financial Statements. Attached as Schedule 4.07 are (a) the audited balance sheets of the Company as of December 31, 2019 and 2020, and the audited statements of operations and statements of cash flows of the Company for the years ended December 31, 2019 and 2020, together with the auditor’s reports thereon (the “Audited Financial Statements”), and (b) the unaudited balance sheet of the Company as of September 30, 2021 and the unaudited statements of operations, statements of redeemable convertible preferred stock and stockholders’ deficit and statements of cash flows of the Company for the nine (9) months ended September 30, 2021 (the “Unaudited Financial Statements” and, together with the Audited Financial Statements, the “Financial Statements”). The Financial Statements present fairly, in all material respects, the consolidated financial position, results of operations, income (loss), changes in equity and cash flows of the Company as of the dates and for the periods indicated in such Financial Statements

[Table of Contents](#)

in conformity with GAAP (except, in the case of the Unaudited Financial Statements, for the absence of footnotes and other presentation items and normal year-end adjustments) and were derived from the books and records of the Company, and the Audited Financial Statements have been audited in accordance with PCAOB auditing standards by a PCAOB qualified auditor.

4.08 Undisclosed Liabilities. There is no liability, debt or obligation against the Company that would be required to be set forth or reserved for on a balance sheet of the Company (and the notes thereto) prepared in accordance with GAAP consistently applied and in accordance with past practice, except for liabilities or obligations (a) reflected or reserved for on the Financial Statements or disclosed in the notes thereto, (b) that have arisen since the date of the most recent balance sheet included in the Unaudited Financial Statements in the ordinary course of business, (c) disclosed in the Company Schedules, (d) arising under or related to this Agreement and/or the performance by the Company of its obligations hereunder (including, for the avoidance of doubt, any Outstanding Company Expenses), or (e) that would not, individually or in the aggregate, reasonably be expected to have a Material Adverse Effect.

4.09 Litigation and Proceedings. Except as set forth in Schedule 4.09, there are no pending or, to the knowledge of the Company, threatened, Actions and, to the knowledge of the Company, there are no pending or threatened investigations against the Company, or otherwise affecting the Company or its assets, including any condemnation or similar proceedings, that would, individually or in the aggregate, have a Material Adverse Effect. Neither the Company nor any property, asset or business of the Company is subject to any Governmental Order, or, to the knowledge of the Company, any continuing investigation by, any Governmental Authority, in each case that would, individually or in the aggregate, reasonably be expected to have a Material Adverse Effect. There is no unsatisfied judgment or any open injunction binding upon the Company which would, individually or in the aggregate, have a material adverse effect on the ability of the Company to consummate the Transactions.

4.10 Compliance with Laws.

(a) Except (i) with respect to compliance with Environmental Laws (as to which certain representations and warranties are made solely pursuant to Section 4.19) and compliance with Tax Laws (which are being made solely pursuant to Sections 4.13 and 4.15), and (ii) where the failure to be, or to have been, in compliance with such Laws would not, individually or in the aggregate, reasonably be expected to have a Material Adverse Effect, the Company is, and since December 31, 2018 has been, in compliance in all material respects with all applicable Laws. The Company has not received any written notice from any Governmental Authority of a violation of any applicable Law by the Company at any time since December 31, 2018, which violation would, individually or in the aggregate, reasonably be expected to have a Material Adverse Effect.

(b) Since December 31, 2018, and except where the failure to be, or to have been, in compliance with such Laws would not, individually or in the aggregate, reasonably be expected to have a Material Adverse Effect, (i) there has been no action taken by the Company or, to the knowledge of Company, any officer, director, manager, employee, agent or representative of Company, in each case, acting on behalf of the Company, in violation of any applicable Anti-Corruption Law, (ii) the Company has not been convicted of violating any Anti-Corruption Laws or subjected to any investigation by a Governmental Authority for violation of any applicable Anti-Corruption Laws, (iii) the Company has conducted or initiated any internal investigation or made a voluntary, directed, or involuntary disclosure to any Governmental Authority regarding any alleged act or omission arising under or relating to any noncompliance with any Anti-Corruption Law and (iv) the Company has not received any written notice or citation from a Governmental Authority for any actual or potential noncompliance with any applicable Anti-Corruption Law.

(c) Since December 31, 2018, and except where the failure to be, or to have been, in compliance with such Laws would not, individually or in the aggregate, reasonably be expected to have a Material Adverse Effect, (i) there has been no action taken by the Company, or, to the knowledge of the Company, any officer, director, manager, employee, agent or representative of the Company, in each case, acting on behalf of the Company, in violation of any applicable International Trade Laws, (ii) the Company has not been convicted of violating any International Trade Laws or subjected to any investigation by a Governmental Authority for violation of any applicable International Trade Laws, (iii) the Company has not conducted or initiated any internal investigation or made a voluntary, directed, or involuntary disclosure to any Governmental Authority regarding any alleged act or omission arising under or relating to any noncompliance with any International Trade Laws and (iv) the Company has not received any written notice or citation from a Governmental Authority for any actual or potential noncompliance with any applicable International Trade Law.

4.11 Intellectual Property.

(a) Schedule 4.11(a) sets forth, as of the date hereof, a true and complete list, including owner, jurisdiction, and serial and application numbers, of all Patents, all registered copyrights, all registered trademarks, all domain name registrations and all pending registration applications for any of the foregoing, in each case, that are owned by the Company (the “Registered Intellectual Property”), all of which are valid, enforceable and subsisting. Except (i) as set forth on Schedule 4.11(a) or (ii) as would not, individually or in the aggregate, reasonably be expected to have a Material Adverse Effect, the Company is the sole and exclusive owner of all right, title and interest in and to all Registered Intellectual Property set forth on Schedule 4.11(a) and all other Owned Intellectual Property free and clear of all Liens, other than Permitted Liens.

(b) Except (i) as set forth on Schedule 4.11(b) or (ii) as would not, individually or in the aggregate, reasonably be expected to have a Material Adverse Effect, as of the date hereof, no Actions are pending or, to the Company’s knowledge, threatened in writing (including unsolicited offers to license Patents) against the Company by any third party claiming infringement, misappropriation or other violation of Intellectual Property owned by such third party or by the Company or in the conduct of the Company’s business. Except (x) as set forth on Schedule 4.11(b) or (y) except as would not, individually or in the aggregate, reasonably be expected to have a Material Adverse Effect, the Company is not a party to any pending Actions, as of the date of this Agreement, claiming infringement, misappropriation or other violation by any third party of any Owned Intellectual Property. Except as set forth on Schedule 4.11(b), within the five (5) years preceding the date of this Agreement, the Company, its products and services and the conduct of the Company’s business have not infringed, misappropriated or otherwise violated the Intellectual Property of any third party, except for such infringements, misappropriations, dilutions and other violations that would not, individually or in the aggregate, reasonably be expected to have a Material Adverse Effect. To the knowledge of the Company, no third party is infringing, misappropriating or otherwise violating any Owned Intellectual Property except for such infringements, misappropriations, dilutions and other violations that would not, individually or in the aggregate, reasonably be expected to have a Material Adverse Effect. To the knowledge of the Company, the Company either own(s), has a valid license to use or otherwise has the lawful right to use, all of the Company Intellectual Property and Company Software and IT Systems used in or necessary to conduct its business, except for such Company Intellectual Property and Company Software and IT Systems with respect to which the lack of such ownership, license or right to use would not, individually or in the aggregate, reasonably be expected to have a Material Adverse Effect, and none of the foregoing will be materially adversely impacted by (nor will require the payment or grant of additional material amounts or material consideration as a result of) the execution, delivery, or performance of this Agreement or any Ancillary Agreement the consummation of the transactions contemplated hereby or thereby.

(c) Except as would not, individually or in the aggregate, reasonably be expected to have a Material Adverse Effect, the Company has undertaken commercially reasonable efforts to protect the confidentiality of any Trade Secrets included in the Owned Intellectual Property.

(d) No director, officer or employee of the Company has any ownership interest in any of the Owned Intellectual Property, except as would not, individually or in the aggregate, reasonably be expected to have a Material Adverse Effect. The Company has implemented policies whereby employees and contractors of the Company who create or develop any Intellectual Property in the course of their employment or provision of services for the Company required to assign to the Company all of such employee’s or contractor’s rights therein, and all such employees and contractors have executed valid written agreements pursuant to which such Persons have assigned (or are obligated to assign) to the Company all of such employee’s or contractor’s rights in and to such Intellectual Property that did not vest automatically in the Company by operation of law (and, in the case of contractors, to the extent such Intellectual Property was intended to be proprietary to the Company), except in each case, as would not, individually or in the aggregate, reasonably be expected to have a Material Adverse Effect.

(e) Except as set forth on Schedule 4.11(e), no government funding and no facilities or other resources of any university, college, other educational institution or research center were used in the development of any Owned Intellectual Property.

(f) To the knowledge of the Company, the Owned Company Software and all Software that is used by the Company is not materially adversely impacted by any viruses, worms, Trojan horses and other known contaminants and does not contain any bugs, errors, or problems of a material nature that would materially disrupt its operation or have a Material Adverse Effect on the operation of other Software. Except as would not, individually or in the aggregate, reasonably be expected to have a Material Adverse Effect, the Company is in material compliance with

[Table of Contents](#)

the terms and conditions (other than attribution or notice requirements) of all material licenses for “free software,” “open source software” or under a similar licensing or distribution term (including the GNU General Public License (GPL), GNU Lesser General Public License (LGPL), Affero General Public License (AGPL), Mozilla Public License (MPL), BSD licenses, the Artistic License, the Netscape Public License, the Sun Community Source License (SCSL), Server Side Public License (SSPL) and the Apache License) (“Open Source Materials”) used by the Company in any way.

(g) Except as would not, individually or in the aggregate, reasonably be expected to have a Material Adverse Effect, the Company has not (i) incorporated Open Source Materials into, or combined Open Source Materials with, any Owned Intellectual Property or Owned Company Software, (ii) distributed Open Source Materials in conjunction with any Owned Intellectual Property or Owned Company Software or (iii) used Open Source Materials in or with any Owned Intellectual Property or Owned Company Software (including any Open Source Materials that require, as a condition of use, modification and/or distribution of such Open Source Materials that other software incorporated into, derived from or distributed with such Open Source Materials be (A) disclosed or distributed in source code form, (B) licensed for the purpose of making derivative works or (C) redistributable at no charge), in each case of the foregoing clauses (i), (ii) and (iii), in such a way that grants or otherwise requires the Company to (x) disclose, distribute, license, grant rights or otherwise provide to any third party any material Owned Intellectual Property, including the source code for any Owned Company Software, or (y) otherwise imposes any limitation, restriction or condition on the right or ability of the Company to use, distribute or enforce any Owner Intellectual Property or Owned Company Software (collectively, “Copyleft Terms”).

(h) Except as set forth on Schedule 4.11(h) (i) with respect to all material Owned Company Software, the Company is in actual possession or control of the applicable source code, object code, documentation, and know-how to the extent required for use, distribution, development, enhancement, maintenance and support of such Owned Company Software, (ii) the Company has not disclosed source code for Owned Company Software to a third party other than to employees or contractors pursuant to a written agreement that protects the Company’s rights in such source code and obligates the employee or contractor to strictly maintain the confidentiality of the source code, (iii) to the knowledge of the Company, no Person other than the Company is in possession of, or has rights to possess, any source code for Owned Company Software (other than contractors engaged to develop or maintain Owned Company Software), and (iv) except as set forth on Schedule 4.11(h) or under non-exclusive licenses granted by the Company to contractors engaged to perform services for the Company or to customers in the ordinary course of business, no Person other than the Company has any rights to use any Owned Company Software. Except as set forth on Schedule 4.11(h), no source code for Owned Company Software is subject to any technology or source code escrow arrangement or obligation. No Person will have a right to access or possess any source code of Owned Company Software (whether as a result of an escrow agreement) or otherwise, as a result of the execution, delivery and performance by Company of this Agreement.

(i) The Owned Company Software performs materially in accordance with its specifications and materials provided to customers corresponding to such Software. Material reported defects and reports of errors are monitored in accordance with customary practices existing between the Company and its customers.

(j) In connection with its collection, storage, transfer (including without limitation, any transfer across national borders) Processing and/or use of any information or Protected Data, the Company is and has been, in compliance with all Privacy and Security Requirements. The Company has commercially reasonable physical, technical, organizational and administrative security measures and policies in place to protect the confidentiality, integrity and availability of all systems, information and Protected Data maintained and collected by it or on its behalf. Except as set forth in Schedule 4.11(i), the Company has not experienced any security incident that has compromised the integrity or availability of the Company’s network, systems, data or information. The Company is and has been in compliance in all material respects with all Privacy and Security Requirements relating to data loss, theft and breach of security notification obligations. The Company has not received, nor provided, any notice of any claims, actions, investigations, inquiries or alleged violations of Privacy and Security Requirements or any other security incidents. To the Company’s knowledge, the Company has not been subject to, and there are no complaints or audits, proceedings, investigations or claims pending against the Company by any Governmental Authority (including any audits relating to the Cybersecurity Maturity Model Certification (CMMC)), or by any Person, in respect of the collection, use, storage, disclosure or other Processing of Protected Data.

(k) Except as would not, individually or in the aggregate, reasonably be expected to have a Material Adverse Effect, (i) the IT Systems are operational and adequate and sufficient for the current and reasonably anticipated future needs of the business of the Company, (ii) to the knowledge of the Company, there have been no unauthorized intrusions or breaches of the security, or material failures of the IT Systems currently used to provide material products to customers in the conduct of their business as it is currently conducted during the two-year period preceding the date hereof, (iii) the Company has in place adequate and commercially reasonable security controls and backup and disaster recovery plans and procedures in place, (iv) to the knowledge of the Company, there have been no unauthorized intrusions or breaches of the IT Systems in the two-year period preceding the date hereof that, pursuant to any legal requirement, would require the Company to notify customers or employees of such breach or intrusion.

4.12 Contracts; No Defaults.

(a) Schedule 4.12(a) contains a listing of all Contracts (other than purchase orders) described in clauses (i) through (ix) below to which, as of the date of this Agreement, the Company is a party or by which its assets are bound (together with all material amendments, waivers or other changes thereto) (collectively, the “Material Contracts”). True, correct and complete copies of the Material Contracts have been delivered to or made available to Acquiror or its agents or representatives.

(i) each employee collective bargaining Contract;

(ii) any Contract pursuant to which the Company (A) licenses or is granted rights from a third party under Intellectual Property that is material to the business of the Company excluding click-wrap, shrink-wrap, off-the-shelf software licenses and any other software licenses that are commercially available on reasonable terms to the public generally with license, maintenance, support and other fees less than \$50,000 per year or (B) licenses or grants to a third party to any rights in or to use Owned Intellectual Property or Owned Company Software (excluding non-exclusive licenses granted to customers, contractors, suppliers or service providers in the ordinary course of business);

(iii) any Contract which restricts in any material respect or contains any material limitations on the ability of the Company to compete in any line of business or in any geographic territory, in each case excluding customary confidentiality agreements (or clauses) or non-solicitation agreements (or clauses);

(iv) any Contract under which the Company has created, incurred, assumed or guaranteed Indebtedness, has the right to draw upon credit that has been extended for Indebtedness, or has granted a Lien on its assets, whether tangible or intangible, to secure any Indebtedness, in each case, in an amount in excess of \$250,000;

(v) any Contract that is a definitive purchase and sale or similar agreement entered into in connection with an acquisition or disposition by the Company since December 31, 2020 of any Person or of any business entity or division or business of any Person (including through merger or consolidation or the purchase of a controlling equity interest in or substantially all of the assets of such Person or by any other manner), but excluding any Contracts in which the applicable acquisition or disposition has been consummated and there are no material obligations ongoing;

(vi) any Contract with outstanding obligations for the sale or purchase of personal property, fixed assets or real estate, other than sales or purchases in the ordinary course of business;

(vii) any Contract not made in the ordinary course of business and not disclosed pursuant to any other clause under this Section 4.12 and expected to result in revenue or require expenditures in excess of \$1,000,000 in the calendar year ending December 31, 2021; and

(viii) any joint venture Contract, partnership agreement, limited liability company agreement or similar Contract that is material to the business of the Company.

(b) Except for any Material Contract that has terminated or will terminate upon the expiration of the stated term thereof prior to the Closing Date and except as would not reasonably be expected to, individually or in the aggregate, have a Material Adverse Effect, (i) such Material Contracts are in full force and effect and represent the legal, valid and binding obligations of the Company and, to the knowledge of the Company, represent the legal,

[Table of Contents](#)

valid and binding obligations of the other parties thereto, and, to the knowledge of the Company, are enforceable by the Company to the extent a party thereto in accordance with their terms, subject in all respects to the effects of bankruptcy, insolvency, fraudulent conveyance, reorganization, moratorium and other laws relating to or affecting creditors' rights generally and general equitable principles (whether considered in a proceeding in equity or at law), (ii) none of the Company or, to the knowledge of the Company, any other party thereto is in material breach of or material default (or would be in material breach, violation or default but for the existence of a cure period) under any Material Contract, (iii) since December 31, 2020, the Company has not received any written or, to the knowledge of the Company, oral claim or notice of material breach of or material default under any Material Contract, (iv) to the knowledge of the Company, no event has occurred which, individually or together with other events, would reasonably be expected to result in a material breach of or a material default under any Material Contract by the Company or, to the knowledge of the Company, any other party thereto (in each case, with or without notice or lapse of time or both) and (v) since December 31, 2020 through the date hereof, the Company has not received written notice from any customer or supplier that is a party to any Material Contract that such party intends to terminate or not renew any Material Contract.

4.13 Company Benefit Plans.

(a) Schedule 4.13(a) sets forth an accurate and complete list of each material Company Benefit Plan. "Company Benefit Plan" means any "employee benefit plan" as defined in Section 3(3) of the Employee Retirement Income Security Act of 1974 ("ERISA"), and each equity-based, retirement, profit sharing, bonus, incentive, severance, separation, change in control, retention, deferred compensation, vacation, paid time off, medical, dental, life or disability plan, program, policy or Contract, and each other material employee compensation or benefit plan, program, policy or Contract that is maintained, sponsored or contributed to (or required to be contributed to) by the Company or pursuant to which the Company has or may have any material liabilities.

(b) The Company has made available or made available to Acquiror accurate summaries of each material Company Benefit Plan.

(c) Except as would not, individually or in the aggregate, reasonably be expected to have a Material Adverse Effect, (i) each Company Benefit Plan and each Contract with any consultant and independent contractor has been administered in compliance with its terms and all applicable Laws, including ERISA and the Code and (ii) all contributions required to be made under the terms of any Company Benefit Plan and any Contract with any consultant and independent contractor as of the date this representation is made have been timely made or, if not yet due, have been properly reflected in the Company's financial statements.

(d) Except as would not, individually or in the aggregate, reasonably be expected to have a Material Adverse Effect, each Company Benefit Plan that is intended to be qualified within the meaning of Section 401(a) of the Code (i) has received a favorable determination or opinion letter as to its qualification or (ii) has been established under a standardized master and prototype or volume submitter plan for which a current favorable Internal Revenue Service advisory letter or opinion letter has been obtained by the plan sponsor and is valid as to the adopting employer. To the knowledge of the Company, no event has occurred that would reasonably be expected to result in the loss of the tax-qualified status of such plans.

(e) Except as would not, individually or in the aggregate, reasonably be expected to have a Material Adverse Effect, neither the Company nor any of its ERISA Affiliates sponsored, maintained, contributed to or was required to contribute to, at any point during the six (6) year period prior to the date hereof, a multiemployer pension plan (as defined in Section 3(37) of ERISA) (a "Multiemployer Plan") or other defined pension plans, in each case, that is subject to Title IV of ERISA or Section 412 of the Code. At any point during the six (6) year period prior to the date hereof, the Company has not had any liability under Title IV of ERISA on account of being considered a single employer under Section 414 of the Code with any other Person. No circumstance or condition exists that would reasonably be expected to result in an actual obligation of the Company to pay money to any Multiemployer Plan or other pension plan that is subject to Title IV of ERISA and that is maintained by an ERISA Affiliate of the Company. No Company Benefit Plan or Contract with any consultant and independent contractor provides post-employment health insurance benefits other than as required under Section 4980B of the Code. For purposes of this Agreement, "ERISA Affiliate" means any entity (whether or not incorporated) that, together with the Company, is considered under common control and treated as one employer under Section 414(b), (c), (m) or (o) of the Code.

[Table of Contents](#)

(f) Except as would not, individually or in the aggregate, reasonably be expected to have a Material Adverse Effect, with respect to the Company Benefit Plans and Contracts with consultants and independent contractors, no administrative investigation, audit or other administrative proceeding by the Department of Labor, the Internal Revenue Service or other Governmental Authorities is pending or, to the knowledge of the Company, threatened.

(g) There have been no “prohibited transactions” within the meaning of Section 4975 of the Code or Sections 406 or 407 of ERISA that are not otherwise exempt under Section 408 of ERISA and no breaches of fiduciary duty (as determined under ERISA) with respect to any Company Benefit Plan. There is no proceeding (other than routine and uncontested claims for benefits) pending or, to the knowledge of the Company, threatened, with respect to any Company Benefit Plan, Contract with any consultant and independent contractor or against the assets of any Company Benefit Plan or such Contract.

(h) Except as set forth in [Schedule 4.13\(h\)](#), the consummation of the Transactions, alone or together with any other event, will not (i) result in a payment or benefit becoming due or payable, to any current or former employee, director, independent contractor or consultant, (ii) increase the amount or value of any benefit or compensation otherwise payable or required to be provided to any current or former employee, director, independent contractor or consultant, (iii) result in the acceleration of the time of payment, vesting or funding of any such benefit or compensation, (iv) result in the forgiveness in whole or in part of any outstanding loans made by the Company to any current or former employee, director, independent contractor or consultant or (v) limit the ability of the Company to terminate any Company Benefit Plan or Contract with any consultant or independent contractor.

(i) No amount or benefit that could be, or has been, received by any current or former employee, officer or director of the Company who is a “disqualified individual” within the meaning of Section 280G of the Code could reasonably be expected to be characterized as an “excess parachute payment” (as defined in Section 280G(b)(1) of the Code) as a result of the consummation of the transactions contemplated by this Agreement. The Company has not agreed to pay, gross up or otherwise indemnify any employee, director or contractor for any tax imposed under Section 4999 of the Code, 409A of the Code or otherwise.

4.14 Labor Matters.

(a) (i) The Company is not a party to or bound by any labor agreement, collective bargaining agreement, or any other labor-related agreements or arrangements with any labor union, labor organization or works council and no such agreements or arrangements are currently being negotiated by the Company, (ii) no labor union or organization, works council or group of employees of the Company has made a pending written demand for recognition or certification and (iii) there are no representation or certification proceedings or petitions seeking a representation proceeding pending or, to the knowledge of the Company, threatened in writing to be brought or filed with the National Labor Relations Board or any other applicable labor relations authority.

(b) Except as would not, individually or in the aggregate, reasonably be expected to have a Material Adverse Effect, the Company (i) is, and since January 1, 2019 has been, in compliance with all applicable Laws regarding employment and employment practices, including, without limitation, all laws respecting terms and conditions of employment, health and safety, employee classification, non-discrimination, wages and hours, immigration, disability rights or benefits, equal opportunity, plant closures and layoffs, affirmative action, workers’ compensation, labor relations, pay equity, overtime pay, employee leave issues, the proper classification of employees and independent contractors, the proper classification of exempt and non-exempt employees, and unemployment insurance, (ii) has not been adjudged to have committed any unfair labor practice as defined by the National Labor Relations Board or received written notice of any unfair labor practice complaint against it pending before the National Labor Relations Board that remains unresolved and (iii) since January 1, 2019, has not experienced any actual or, to the knowledge of the Company, threatened arbitrations, grievances, labor disputes, strikes, lockouts, picketing, hand-billing, slowdowns or work stoppages against or affecting the Company.

(c) Except as would not, individually or in the aggregate, reasonably be expected to have a Material Adverse Effect, the Company is not delinquent in payments to any employees or former employees for any services or amounts required to be reimbursed or otherwise paid.

[Table of Contents](#)

(d) To the knowledge of the Company, no employee of the Company at the level of senior vice president or above is in any material respect in violation of any term of any employment agreement, nondisclosure agreement, non-competition agreement, restrictive covenant or other obligation: (i) to the Company or (ii) to a former employer of any such employee relating (A) to the right of any such employee to be employed by the Company or (B) to the knowledge or use of Trade Secrets or proprietary information.

(e) To the knowledge of the Company, all employees of the Company are legally permitted to be employed by the Company in the jurisdiction in which such employees are employed in their current job capacities.

(f) The Company has not incurred any material liability or obligation under the Worker Adjustment and Retraining Notification Act of 1988 or any similar state or local Law that remains unsatisfied.

4.15 Taxes. With respect to the following representations and warranties set forth in this Section 4.15 (other than Section 4.15(k)), except as would not, individually or in the aggregate, reasonably be expected to have a Material Adverse Effect:

(a) Except as set forth on Schedule 4.15(a), all Tax Returns required by Law to be filed by the Company have been duly and timely filed (after giving effect to any valid extensions of time in which to make such filings).

(b) All amounts of Taxes shown due on any Tax Returns of the Company and all other amounts of Taxes owed by the Company have been timely paid.

(c) The Company has (i) withheld or collected all amounts of Taxes required to have been withheld or collected by it in connection with amounts paid to any employee, independent contractor, director, agent, manager, supplier, lender, creditor, shareholder (including the Company Stockholders) or any other third party, and (ii) reported and timely remitted such amounts required to have been withheld or collected, reported and remitted to the appropriate Governmental Authority. All Forms W-2 or 1099 or other Tax Returns required with respect thereto have been properly completed and timely filed.

(d) The Company has (i) properly collected all sales Taxes required to be collected in the time and manner required by applicable Law and remitted all such sales Taxes to the applicable Taxing authority in the time and in the manner required by applicable Law and (ii) returned all sales Taxes erroneously collected from any Person to such Person in the time and in the manner required by applicable Law. The Company has properly requested, received and retained all necessary exemption certificates and other documentation supporting any claimed exemption of waiver of Taxes on sales or similar transactions as to which it would otherwise have been obligated to collect or withhold Taxes.

(e) Except as set forth on Schedule 4.15(e), the Company is not currently engaged in any audit, administrative or judicial proceeding with a taxing authority with respect to Taxes. The Company has not received any written notice from a taxing authority of a proposed deficiency of an amount of Taxes, other than any such deficiencies that have since been resolved. Within the last three (3) years, no written claim has been made by any Governmental Authority in a jurisdiction where the Company does not file a Tax Return that such entity is or may be subject to Taxes by that jurisdiction in respect of Taxes that would be the subject of such Tax Return, which claim has not been resolved. There are no outstanding agreements extending or waiving the statutory period of limitations applicable to any claim for, or the period for the collection or assessment or reassessment of, Taxes of the Company, and no written request for any such waiver or extension is currently pending.

(f) Neither the Company nor any predecessor thereof has constituted either a “distributing corporation” or a “controlled corporation” in a distribution of stock qualifying for tax-free treatment under Section 355 of the Code (or so much of Section 356 of the Code as relates to Section 355 of the Code) in the two years prior to the date of this Agreement.

(g) The Company has not been a party to any “listed transaction” within the meaning of Treasury Regulation Section 1.6011-4(b)(2) for a taxable period for which the applicable statute of limitations remains open.

(h) Except with respect to deferred revenue or prepaid subscription revenues collected by the Company in the ordinary course of business, the Company will not be required to include any item of income in, or exclude any item of deduction from, taxable income for any taxable period (or portion thereof) ending after the Closing Date as a result of any: (A) change in method of accounting for a taxable period (or portion thereof) ending on or prior to the Closing Date and made prior to the Closing; (B) ruling by, or written agreement with, a Governmental

[Table of Contents](#)

Authority (including any closing agreement pursuant to Section 7121 of the Code or any similar provision of Tax Law) issue or executed prior to the Closing; (C) installment sale or open transaction disposition made prior to the Closing; (D) prepaid amount received prior to the Closing; (E) intercompany transaction or excess loss accounts described in the Treasury Regulations promulgated under Section 1502 of the Code (or any corresponding or similar provision of state, local or foreign income Tax Law) that existed prior to the Closing; or (F) Section 965 of the Code.

(i) There are no Liens with respect to Taxes on any of the assets of the Company, other than Permitted Liens.

(j) The Company does not have any liability for the Taxes of any other Person (i) under Treasury Regulation Section 1.1502-6 (or any similar provision of state, local or foreign Law) or (ii) as a transferee or successor.

(k) The Company is not a party to or bound by, nor does it have any obligation to, any Governmental Authority or other Person under any Tax allocation, Tax sharing or Tax indemnification agreements (except, in each case, for any such agreements that are commercial contracts not primarily relating to Taxes).

(l) The Company has not made an election under Section 1362(a) of the Code to be treated as an "S corporation" for U.S. federal, state or local income tax purposes.

(m) The Company is not, and has not been at any time during the five (5) year period ending on the Closing Date, a "United States real property holding corporation" within the meaning of Section 897(c)(2) of the Code.

(n) To the knowledge of the Company, the Company is in compliance with applicable United States and foreign transfer pricing Laws and regulations in all material respects, including the execution and maintenance of contemporaneous documentation substantiating the transfer pricing practices and methodology of the Company.

(o) To the knowledge of the Company, there are no facts, circumstances or plans that, either alone or in combination, could reasonably be expected to prevent the Transactions from qualifying for the Intended Tax Treatment.

(p) Other than the representations and warranties set forth in [Section 4.13](#), this [Section 4.15](#) contains the exclusive representations and warranties of the Company with respect to Tax matters. Nothing in this [Section 4.15](#) shall be construed as providing a representation or warranty with respect to (i) other than the representations and warranties set forth in [Section 4.15\(g\)](#), any taxable period (or portion thereof) beginning following the Closing Date or (ii) the existence, amount, expiration date or limitations on (or availability of) any Tax attribute.

4.16 Brokers' Fees. Except as described on [Schedule 4.16](#), no broker, finder, investment banker or other Person is entitled to any brokerage fee, finders' fee or other commission in connection with the transactions contemplated by this Agreement based upon arrangements made by the Company for which the Company has any obligation.

4.17 Insurance. [Schedule 4.17](#) contains a list of all material policies or programs of self-insurance of property, fire and casualty, product liability, workers' compensation and other forms of insurance held by, or for the benefit of, the Company as of the date of this Agreement. True, correct and complete copies or comprehensive summaries of such insurance policies have been made available to Acquiror. With respect to each such insurance policy required to be listed on [Schedule 4.17](#), except as would not, individually or in the aggregate, reasonably be expected to have a Material Adverse Effect, (i) all premiums due have been paid (other than retroactive or retrospective premium adjustments and adjustments in the respect of self-funded general liability and automobile liability fronting programs, self-funded health programs and self-funded general liability and automobile liability front programs, self-funded health programs and self-funded workers' compensation programs that are not yet, but may be, required to be paid with respect to any period end prior to the Closing Date), (ii) the policy is legal, valid, binding and enforceable in accordance with its terms and, except for policies that have expired under their terms in the ordinary course, is in full force and effect, (iii) the Company is not in breach or default (including any such breach or default with respect to the payment of premiums or the giving of notice), and, to the Company's knowledge, no event has occurred which, with notice or the lapse of time or both, would constitute such a breach or default, or permit termination or modification, under the policy, and to the knowledge of the Company, no such action has been threatened and (iv) as of the date hereof, no written notice of cancellation, non-renewal, disallowance or reduction in coverage or claim or termination has been received other than in connection with ordinary renewals.

[Table of Contents](#)

4.18 Real Property: Assets.

(a) The Company does not own any real property. The Company is not a party to any agreement or option to purchase any real property or material interest therein.

(b) Schedule 4.18(b) contains a true, correct and complete list of all Leased Real Property. The Company has made available to Acquiror true, correct and complete copies of the leases, subleases, licenses and occupancy agreements (including all modifications, amendments, supplements, guaranties, extensions, renewals, waivers, side letters and other agreements relating thereto) for the Leased Real Property to which the Company is a party (the "Real Estate Lease Documents"), and such deliverables comprise all Real Estate Lease Documents relating to the Leased Real Property.

(c) Except as set forth in Schedule 4.18(c), each Real Estate Lease Document (i) is a legal, valid, binding and enforceable obligation of the Company and, to the knowledge of the Company, the other parties thereto, as applicable, subject to applicable bankruptcy, insolvency, fraudulent conveyance, reorganization, moratorium and similar Laws affecting creditors' rights generally and subject, as to enforceability, to general principles of equity, and each such Real Estate Lease Document is in full force and effect, (ii) has not been amended or modified except as reflected in the Real Estate Lease Documents made available to Acquiror and (iii) to the knowledge of the Company, covers the entire estate it purports to cover and, subject to securing the consents or approvals, if any, required under the Real Estate Lease Documents to be obtained from any landlord, or lender to landlord (as applicable), in connection with the execution and delivery of this Agreement by the Company or the consummation of the transaction contemplated hereby by the Company, upon the consummation of the transactions contemplated by this Agreement, will entitle Acquiror or its Subsidiaries to the exclusive use (subject to the terms of the respective Real Estate Lease Documents in effect with respect to the Leased Real Property), occupancy and possession of the premises specified in the Real Estate Lease Documents for the purpose specified in the Real Estate Lease Documents.

(d) No material default or breach by (i) the Company or (ii) to the knowledge of the Company, any other parties thereto, as applicable, presently exists under any Real Estate Lease Documents. The Company has not received written or, to the knowledge of the Company, oral notice of default or breach under any Real Estate Lease Document which has not been cured. To the knowledge of the Company, no event has occurred that, and no condition exists which, with notice or lapse of time or both, would constitute a material default or breach under any Real Estate Lease Document by the Company or by the other parties thereto. The Company has not subleased or otherwise granted any Person the right to use or occupy any Leased Real Property or its Subsidiaries to the exclusive use (subject to the terms of the respective Real Estate Lease Documents in effect with respect to the Leased Real Property), occupancy and possession of the premises specified in the Real Estate Lease Documents for the purpose specified in the Real Estate Lease Documents. The Company has a good and valid leasehold title to each Leased Real Property subject only to Permitted Liens.

(e) The Company has not received any written notice that remains outstanding as of the date of this Agreement that the current use and occupancy of the Leased Real Property and the improvements thereon (i) are prohibited by any Lien or law other than Permitted Liens or (ii) are in material violation of any of the recorded covenants, conditions, restrictions, reservations, easements or agreements applicable to such Leased Real Property.

4.19 Environmental Matters. Except as would not, individually or in the aggregate, reasonably be expected to have a Material Adverse Effect:

(a) the Company is and, during the last three (3) years, has been in compliance with all Environmental Laws;

(b) there has been no release of any Hazardous Materials at, in, on or under any Leased Real Property or, to the knowledge of the Company, at, in, on or under any formerly owned or leased real property, in each case during the time that the Company owned or leased such property;

(c) the Company is not subject to and has not received any Governmental Order that remains unresolved relating to any non-compliance with Environmental Laws by the Company or the investigation, sampling, monitoring, treatment, remediation, removal or cleanup of Hazardous Materials;

(d) no Action is pending or, to the knowledge of the Company, threatened in writing and no investigation is pending or, to the knowledge of the Company, threatened in writing, in each case with respect to the Company's compliance with or liability under Environmental Law;

[Table of Contents](#)

(e) the Company has made available to Acquiror all material environmental reports (including any Phase One or Phase Two environmental site assessments) and audits relating to the Leased Real Property or any formerly owned or operated real property in its possession, custody or reasonable control.

(f) Notwithstanding any other provision of this [Article IV](#), this [Section 4.19](#) contains the exclusive representations and warranties of the Company with respect to environmental matters.

4.20 [Absence of Changes](#). Except (i) as set forth on [Schedule 4.20](#) and (ii) in connection with the Transactions, from December 31, 2020 through and including the date of this Agreement, the Company (1) has, in all material respects, conducted its business and operated its properties in the ordinary course of business (including, for the avoidance of doubt, recent past practice in light of COVID-19), and (2) has not taken any action that is both material to the Company and would require the consent of Acquiror pursuant to [Section 6.01](#) if such action had been taken after the date hereof.

4.21 [Affiliate Agreements](#). Except as set forth on [Schedule 4.21](#) and except for, in the case of any employee, officer or director, any employment or indemnification Contract or Contract with respect to the issuance of equity in the Company, the Company is not a party to any transaction, agreement, arrangement or understanding with any (i) present or former executive officer or director of any of the Company, (ii) beneficial owner (within the meaning of Section 13(d) of the Exchange Act) of 5% or more of the capital stock or equity interests of any of the Company or (iii) Affiliate, “associate” or member of the “immediate family” (as such terms are respectively defined in Rules 12b-2 and 16a-1 under the Exchange Act) of any of the foregoing (each of the foregoing, a “[Company Affiliate Agreement](#)”).

4.22 [Internal Controls](#). The Company maintains a system of internal accounting controls designed to provide reasonable assurance that: (a) transactions are executed in accordance with management’s general or specific authorizations; (b) transactions are recorded as necessary to permit preparation of financial statements in conformity with GAAP and to maintain asset accountability; (c) access to assets is permitted only in accordance with management’s general or specific authorization; and (d) the recorded accountability for assets is compared with the existing assets at reasonable intervals and appropriate action is taken with respect to any differences.

4.23 [Permits](#). The Company has timely obtained and holds all material Permits (the “[Material Permits](#)”) that are required to own, lease or operate its properties and assets and to conduct its business as currently conducted, except where the failure to obtain the same would not, individually or in the aggregate, reasonably be expected to have a Material Adverse Effect. Except as would not, individually or in the aggregate, reasonably be expected to have a Material Adverse Effect, (a) each Material Permit is in full force and effect in accordance with its terms, (b) no outstanding written notice of revocation, cancellation or termination of any Material Permit has been received by the Company, (c) to the knowledge of the Company, none of such Permits upon its termination or expiration in the ordinary due course will not be renewed or reissued in the ordinary course of business upon terms and conditions substantially similar to its existing terms and conditions, (d) there are no Actions pending or, to the knowledge of the Company, threatened, that seek the revocation, cancellation, limitation, restriction or termination of any Material Permit and (e) the Company is in compliance with all Material Permits applicable to the Company.

4.24 [Registration Statement](#). None of the information relating to the Company supplied by the Company, or by any other Person acting on behalf of the Company, in writing specifically for inclusion or incorporation by reference in the Registration Statement will, as of the time the Registration Statement becomes effective under the Securities Act, contain any untrue statement of a material fact or omit to state a material fact necessary to make the statements therein, in light of the circumstances under which they were made, not misleading; provided, however, notwithstanding the foregoing provisions of this [Section 4.24](#), no representation or warranty is made by the Company with respect to information or statements made or incorporated by reference in the Registration Statement that were not supplied by or on behalf of the Company for use therein.

4.25 [Operation of the Business during COVID-19](#). None of the Company’s actions and inactions prior to the date of this Agreement in response to COVID-19: (i) has resulted in the Company experiencing any material business interruption or material losses, or (ii) if taken following the date of this Agreement would constitute a Material Adverse Effect or a material breach of the covenants set forth in [Section 6.01](#).

4.26 [No Additional Representations and Warranties](#). Except as otherwise expressly provided in this [Article IV](#) (as modified by the Company Schedules), the Company expressly disclaims any representations or warranties of any kind or nature, express or implied, including as to the condition, value or quality of the Company or the Company’s

assets, and the Company specifically disclaims any representation or warranty with respect to merchantability, usage, suitability or fitness for any particular purpose with respect to the Company's assets, or as to the workmanship thereof, or the absence of any defects therein, whether latent or patent, it being understood that such subject assets are being acquired "as is, where is" on the Closing Date, and in their present condition, and Acquiror and Merger Sub shall rely on their own examination and investigation thereof. None of the Company's Affiliates or any of their respective directors, officers, employees, stockholders, partners, members or representatives has made, or is making, any representation or warranty whatsoever to Acquiror or its Affiliates, and no such party shall be liable in respect of the accuracy or completeness of any information provided to Acquiror or its Affiliates.

**ARTICLE V
REPRESENTATIONS AND WARRANTIES
OF ACQUIROR AND MERGER SUB**

Except as set forth in the (A) Acquiror and Merger Sub Schedules to this Agreement (each of which qualifies (a) the correspondingly numbered representation, warranty or covenant if specified therein and (b) such other representations, warranties or covenants where its relevance as an exception to (or disclosure for purposes of) such other representation, warranty or covenant is reasonably apparent) or (B) Acquiror SEC Reports filed or furnished by Acquiror on or prior to the date hereof (excluding (x) any disclosures in such Acquiror SEC Reports under the headings "Risk Factors", "Cautionary Note Regarding Forward-Looking Statements" or "Qualitative and Quantitative Disclosures about Market Risk" and other disclosures that are predictive, cautionary, or forward looking in nature and (y) any exhibits or other documents appended thereto), each of Acquiror and Merger Sub represents and warrants to the Company as follows:

5.01 Corporate Organization.

(a) Acquiror is duly incorporated and is validly existing as a corporation in good standing under the Laws of Delaware and has the corporate power and authority to own, lease or operate its assets and properties and to conduct its business as it is now being conducted. The copies of the organizational documents of Acquiror previously delivered by Acquiror to the Company are true, correct and complete and are in effect as of the date of this Agreement. Acquiror is, and at all times has been, in compliance in all material respects with all restrictions, covenants, terms and provisions set forth in its respective organizational documents. Acquiror is duly licensed or qualified and in good standing as a foreign corporation in all jurisdictions in which its ownership of property or the character of its activities is such as to require it to be so licensed or qualified, except where failure to be so licensed or qualified has not and would not, individually or in the aggregate, reasonably be expected to have a material adverse effect on the ability of Acquiror or Merger Sub to enter into and perform its obligations under this Agreement and consummate the Transactions.

(b) Merger Sub is a corporation duly organized, validly existing and in good standing under the Laws of Texas, with full corporate power and authority to enter into this Agreement and perform its obligations hereunder. Other than Merger Sub, Acquiror has no other Subsidiaries or any equity or other interests in any other Person.

5.02 Due Authorization.

(a) Each of Acquiror and Merger Sub has all requisite corporate or entity power and authority to execute and deliver this Agreement and each Ancillary Agreement to this Agreement to which it is a party and (subject to the approvals described in Section 5.07) (in the case of Acquiror), upon receipt of the Acquiror Stockholder Approval and effectiveness of the PubCo Charter, to perform its respective obligations hereunder and thereunder and to consummate the transactions contemplated hereby and thereby. The execution, delivery and performance of this Agreement and such Ancillary Agreements by each of Acquiror and Merger Sub and the consummation of the transactions contemplated hereby and thereby have been duly, validly and unanimously authorized by all requisite action and (in the case of Acquiror), except for the Acquiror Stockholder Approval, no other corporate or equivalent proceeding on the part of Acquiror or Merger Sub is necessary to authorize this Agreement or such Ancillary Agreements or Acquiror's or Merger Sub's performance hereunder or thereunder. This Agreement has been, and each such Ancillary Agreement will be, duly and validly executed and delivered by each of Acquiror and Merger Sub and, assuming due authorization and execution by each other party hereto and thereto, this Agreement constitutes, and each such Ancillary Agreement will constitute, a legal, valid and binding obligation of each of Acquiror and Merger Sub, enforceable against each of Acquiror and Merger Sub in accordance with its terms, subject to applicable bankruptcy, insolvency, fraudulent conveyance, reorganization, moratorium and similar Laws affecting creditors' rights generally and subject, as to enforceability, to general principles of equity.

(b) The affirmative vote of a majority of the votes cast at the Special Meeting, by the holders of the Acquiror Common Stock present in person or represented by proxy and entitled to vote thereon, is required to approve: (i) the Transaction Proposal, (ii) the Stock Issuance Proposal, (iii) the Amendment Proposal, and (iv) the Acquiror Incentive Plan Proposal, in each case, assuming a quorum is present (the approval by Acquiror Stockholders of all of the foregoing, collectively, the “Acquiror Stockholder Approval”). The Acquiror Stockholder Approval are the only votes of any of Acquiror’s capital stock necessary in connection with the entry into this Agreement by Acquiror, and the consummation of the transactions contemplated hereby (including the Closing).

(c) The Acquiror Board has duly adopted resolutions: (i) determined that this Agreement and the transactions contemplated hereby and thereby (including the approval of the PubCo Charter) are fair to, advisable and in the best interests of Acquiror and its stockholders; (ii) determined that the fair market value of the Company is equal to at least 80% of the amount held in the Trust Account (less any deferred underwriting commissions and taxes payable on interest earned) as of the date hereof; (iii) approved the transactions contemplated by this Agreement as a Business Combination; (iv) approved this Agreement, the Subscription Agreements and the transactions contemplated hereby and thereby (including the PubCo Charter), the execution and delivery by Acquiror of this Agreement, the Subscription Agreements and Acquiror’s performance of its obligations under this Agreement, the Subscription Agreements and consummation of the transactions contemplated hereby and thereby and (v) resolved to recommend to the stockholders of Acquiror approval of each of the matters requiring Acquiror Stockholder approval. The Board of Directors of Merger Sub has duly adopted resolutions (i) approving this Agreement and the transactions contemplated hereby, the execution and delivery by Merger Sub of this Agreement and Merger Sub’s performance of its obligations under this Agreement and consummation of the transactions contemplated hereby, (ii) declared this Agreement and the merger to be advisable and in the best interests of Merger Sub and its sole stockholder and (iii) recommended that Acquiror approve and adopt this Agreement and the Merger in its capacity as the sole stockholder of Merger Sub.

5.03 No Conflict. The execution, delivery and performance of this Agreement by each of Acquiror and Merger Sub and (in the case of Acquiror), upon receipt of the Acquiror Stockholder Approval and the effectiveness of the PubCo Charter, the consummation of the transactions contemplated hereby do not and will not (a) conflict with or violate any provision of, or result in the breach of, the Acquiror Organizational Documents, any organizational documents of any Subsidiaries of Acquiror or any of the organizational documents of Merger Sub, (b) conflict with or result in any violation of any provision of any Law or Governmental Order applicable to each of Acquiror or Merger Sub or any of their respective properties or assets, (c) violate, conflict with, result in a breach of any provision of or the loss of any benefit under, constitute a default (or an event which, with notice or lapse of time or both, would constitute a default) under, or result in the termination or acceleration of, or a right of termination, cancellation, modification, acceleration or amendment under, accelerate the performance required by, or result in the acceleration or trigger of any payment, posting of collateral (or right to require the posting of collateral), time of payment, vesting or increase in the amount of any compensation or benefit payable pursuant to, any of the terms, conditions or provisions of any Contract to which each of Acquiror or Merger Sub or any their respective Subsidiaries is a party or by which any of their respective assets or properties may be bound or affected or (d) result in the creation of any Lien upon any of the properties or assets of Acquiror or Merger Sub, except (in the case of clauses (b), (c) or (d) above) for such violations, conflicts, breaches or defaults which would not, individually or in the aggregate, reasonably be expected to have a material adverse effect on the ability of Acquiror or Merger Sub to enter into, perform its obligations under this Agreement and consummate the Transactions.

5.04 Litigation and Proceedings. There are no pending or, to the knowledge of Acquiror, threatened, Actions and, to the knowledge of Acquiror, there are no pending or threatened investigations, in each case, against Acquiror, or otherwise affecting Acquiror or its assets, including any condemnation or similar proceedings, which, if determined adversely, could, individually or in the aggregate, reasonably be expected to have a material adverse effect on the ability of Acquiror or Merger Sub to enter into, perform its obligations under this Agreement and consummate the Transactions. There is no unsatisfied judgment or any open injunction binding upon Acquiror which could, individually or in the aggregate, reasonably be expected to have a material adverse effect on the ability of Acquiror or Merger Sub to enter into, perform its obligations under this Agreement and consummate the Transactions.

5.05 Compliance with Laws.

(a) Except where the failure to be, or to have been, in compliance with such Laws would not, individually or in the aggregate, reasonably be expected to have a material adverse effect on the ability of Acquiror or Merger Sub to enter into, perform its obligations under this Agreement and consummate the Transactions, Acquiror and its Subsidiaries are, and since the date of incorporation of Acquiror have been, in compliance in all material respects with all applicable Laws. Neither Acquiror nor its Subsidiaries has received any written notice from any Governmental Authority of a violation of any applicable Law by Acquiror or its Subsidiaries at any time since the date of incorporation of Acquiror, which violation would reasonably be expected to have a material adverse effect on the ability of Acquiror or Merger Sub to enter into, perform its obligations under this Agreement and consummate the Transactions.

(b) Since the date of incorporation of Acquiror, and except where the failure to be, or to have been, in compliance with such Laws would not, individually or in the aggregate, reasonably be expected to have a material adverse effect on the ability of Acquiror or Merger Sub to enter into, perform its obligations under this Agreement and consummate the Transactions, (i) there has been no action taken by Acquiror, its Subsidiaries, or, to the knowledge of Acquiror, any officer, director, manager, employee, agent or representative of Acquiror or its Subsidiaries, in each case, acting on behalf of the Acquiror or its Subsidiaries, in violation of any applicable Anti-Corruption Law, (ii) neither Acquiror nor its Subsidiaries has been convicted of violating any Anti-Corruption Laws or subjected to any investigation by a Governmental Authority for violation of any applicable Anti-Corruption Laws, (iii) neither Acquiror nor its Subsidiaries has conducted or initiated any internal investigation or made a voluntary, directed, or involuntary disclosure to any Governmental Authority regarding any alleged act or omission arising under or relating to any noncompliance with any Anti-Corruption Law and (iv) neither Acquiror nor its Subsidiaries has received any written notice or citation from a Governmental Authority for any actual or potential noncompliance with any applicable Anti-Corruption Law.

(c) Since the date of incorporation of Acquiror, and except where the failure to be, or to have been, in compliance with such Laws would not, individually or in the aggregate, reasonably be expected to have a material adverse effect on the ability of Acquiror or Merger Sub to enter into and perform its obligations under this Agreement and consummate the Transactions, (i) there has been no action taken by Acquiror, its Subsidiaries, or, to the knowledge of Acquiror, any officer, director, manager, employee, agent or representative of Acquiror or its Subsidiaries, in each case, acting on behalf of the Acquiror or its Subsidiaries, in violation of any applicable International Trade Laws, (ii) neither Acquiror nor its Subsidiaries has been convicted of violating any International Trade Laws or subjected to any investigation by a Governmental Authority for violation of any applicable International Trade Laws, (iii) neither Acquiror nor its Subsidiaries has conducted or initiated any internal investigation or made a voluntary, directed, or involuntary disclosure to any Governmental Authority regarding any alleged act or omission arising under or relating to any noncompliance with any International Trade Laws and (iv) neither Acquiror nor its Subsidiaries has received any written notice or citation from a Governmental Authority for any actual or potential noncompliance with any applicable International Trade Law.

5.06 Employee Benefit Plans. Except as may be contemplated by the Acquiror Incentive Plan Proposal, neither Acquiror, Merger Sub, nor any of their respective Subsidiaries maintains, contributes to or has any obligation or liability, or could reasonably be expected to have any obligation or liability, under, any “employee benefit plan” as defined in Section 3(3) of ERISA or any other material, written plan, policy, program, arrangement or agreement (other than standard employment agreements that can be terminated at any time without severance or termination pay and upon notice of not more than 60 days or such longer period as may be required by applicable Law) providing compensation or benefits to any current or former director, officer, employee, independent contractor or other service provider, including, without limitation, all incentive, bonus, deferred compensation, vacation, holiday, cafeteria, medical, disability, stock purchase, stock option, stock appreciation, phantom stock, restricted stock or other stock-based compensation plans, policies, programs, practices or arrangements, but not including any plan, policy, program, arrangement or agreement that covers only former directors, officers, employees, independent contractors and service providers and with respect to which Acquiror, Merger Sub or any of their respective Subsidiaries have no remaining obligations or liabilities (collectively, the “Acquiror Benefit Plans”) and neither the execution and delivery of this Agreement nor the consummation of the transactions contemplated by this Agreement (either alone or in combination with another event) will (i) result in any material compensatory payment (including severance, unemployment compensation, golden

[Table of Contents](#)

parachute, bonus or otherwise) becoming due to any shareholder, director, officer or employee of Acquiror, Merger Sub or any of their respective Subsidiaries, or (ii) result in the acceleration, vesting or creation of any rights of any shareholder, director, officer or employee of Acquiror, Merger Sub or any of their respective Subsidiaries to payments or benefits or increases in any existing payments or benefits or any loan forgiveness.

5.07 Governmental Authorities: Consents. Assuming the truth and completeness of the representations and warranties of the Company contained in this Agreement, no consent, approval or authorization of, or designation, declaration or filing with, any Governmental Authority is required on the part of Acquiror or Merger Sub with respect to Acquiror's or Merger Sub's execution or delivery of this Agreement or the consummation of the transactions contemplated hereby, except for applicable requirements of the HSR Act and any other applicable Antitrust Law, Securities Laws, Nasdaq and the filing and effectiveness of the Certificate of Merger and the PubCo Charter.

5.08 Trust Account.

(a) Set forth on Schedule 5.08 is a true and accurate record, as of the date identified on Schedule 5.08, of the balance invested in a trust account at Morgan Stanley (the "Trust Account"), maintained by Continental Stock Transfer & Trust Company, a New York corporation, acting as trustee (the "Trustee"), pursuant to the Investment Management Trust Agreement, dated July 14, 2021, by and between Acquiror and the Trustee (the "Trust Agreement"). The Trust Agreement is in full force and effect and is a legal, valid and binding obligation of Acquiror and, to the knowledge of Acquiror, the Trustee, enforceable in accordance with its terms, subject to applicable bankruptcy, insolvency, fraudulent conveyance, reorganization, moratorium and similar Laws affecting creditors' rights generally and subject, as to enforceability, to general principles of equity. The Trust Agreement has not been terminated, repudiated, rescinded, amended or supplemented or modified, in any respect, and, to the knowledge of Acquiror, no such termination, repudiation, rescission, amendment, supplement or modification is contemplated. There are no side letters and there are no agreements, Contracts, arrangements or understandings, whether written or oral, with the Trustee or any other Person that would (i) cause the description of the Trust Agreement in the Acquiror SEC Reports to be inaccurate or (ii) entitle any Person (other than any Acquiror Stockholder who is a Redeeming Stockholder) to any portion of the proceeds in the Trust Account. Prior to the Closing, none of the funds held in the Trust Account may be released except in accordance with the Trust Agreement, Acquiror Organizational Documents and Acquiror's final prospectus dated July 16, 2021. Amounts in the Trust Account are invested in United States Government securities or in money market funds meeting certain conditions under Rule 2a-7 promulgated under the Investment Company Act of 1940. Acquiror has performed all material obligations required to be performed by it to date under, and is not in material default, breach or delinquent in performance or any other respect (claimed or actual) in connection with, the Trust Agreement, and no event has occurred which, with due notice or lapse of time or both, would constitute such a default or breach thereunder. There are no Actions pending or, to the knowledge of Acquiror, threatened with respect to the Trust Account. Acquiror has not released any money from the Trust Account (other than interest income earned on the principal held in the Trust Account as permitted by the Trust Agreement). As of the Effective Time, the obligations of Acquiror to dissolve or liquidate pursuant to the Acquiror Organizational Documents shall terminate, and, as of the Effective Time, Acquiror shall have no obligation whatsoever pursuant to the Acquiror Organizational Documents to dissolve and liquidate the assets of Acquiror by reason of the consummation of the transactions contemplated hereby. Following the Effective Time, no Acquiror Stockholder shall be entitled to receive any amount from the Trust Account except to the extent such Acquiror Stockholder is a Redeeming Stockholder.

(b) As of the date hereof, assuming the accuracy of the representations and warranties of the Company herein and the compliance by the Company with its respective obligations hereunder, Acquiror has no reason to believe that any of the conditions to the use of funds in the Trust Account will not be satisfied or funds available in the Trust Account will not be available to Acquiror on the Closing Date.

(c) As of the date hereof, Acquiror does not have, or have any present intention, agreement, arrangement or understanding to enter into or incur, any obligations with respect to or under any Indebtedness.

5.09 Taxes.

(a) All material Tax Returns required by Law to be filed by Acquiror, if any, have been duly and timely filed (after giving effect to any valid extensions of time in which to make such filings).

(b) All material amounts of Taxes shown due on any Tax Returns of Acquiror and all other material amounts of Taxes owed by Acquiror have been timely paid.

(c) Acquiror has (i) withheld all material amounts of Taxes required to have been withheld by it in connection with amounts paid to any employee, independent contractor, director, agent, manager, supplier, lender, creditor, shareholder or any other third party, and (ii) remitted such amounts required to have been remitted to the appropriate Governmental Authority. All Forms W-2 or 1099 or other Tax Returns required with respect thereto have been properly completed and timely filed.

(d) Acquiror is not currently engaged in any material audit, administrative or judicial proceeding with a taxing authority with respect to Taxes. Acquiror has not received any written notice from a taxing authority of a proposed deficiency of a material amount of Taxes, other than any such deficiencies that have since been resolved. No written claim has been made by any Governmental Authority in a jurisdiction where Acquiror does not file a Tax Return that such entity is or may be subject to Taxes by that jurisdiction in respect of Taxes that would be the subject of such Tax Return, which claim has not been resolved. There are no outstanding agreements extending or waiving the statutory period of limitations applicable to any claim for, or the period for the collection or assessment or reassessment of, material Taxes of Acquiror, and no written request for any such waiver or extension is currently pending.

(e) To the knowledge of Acquiror, there are no facts, circumstances or plans that, either alone or in combination, could reasonably be expected to prevent the Transactions from qualifying for the Intended Tax Treatment.

(f) Other than the representations and warranties set forth in [Section 5.06](#), this [Section 5.09](#) contains the exclusive representations and warranties of Acquiror with respect to Tax matters. Nothing in this [Section 5.09](#) shall be construed as providing a representation or warranty with respect to (i) any taxable period (or portion thereof) beginning following the Closing Date or (ii) the existence, amount, expiration date or limitations on (or availability of) any Tax attribute.

5.10 Brokers' Fees. Except for fees described on [Schedule 5.10](#) (including the amounts owed with respect thereto), no broker, finder, investment banker or other Person is entitled to any brokerage fee, finders' fee or other commission (including any deferred underwriting commission) in connection with the transactions contemplated by this Agreement (including the Equity Financing) or as a result of the Closing, in each case, including based upon arrangements made by Acquiror or Merger Sub or any of their respective Affiliates, including the Sponsor.

5.11 Acquiror SEC Reports; Financial Statements; Sarbanes-Oxley Act.

(a) Acquiror has filed in all required reports, schedules, forms, statements and other documents required to be filed by it with the SEC since the date of incorporation of the Acquiror (collectively, as they have been amended since the time of their filing and including all exhibits thereto, the "[Acquiror SEC Reports](#)"). None of the Acquiror SEC Reports, as of their respective dates (or if amended or superseded by a filing prior to the date of this Agreement or the Closing Date, then on the date of such filing), contained any untrue statement of a material fact or omitted to state a material fact required to be stated therein or necessary in order to make the statements made therein, in light of the circumstances under which they were made, not misleading. The audited financial statements and unaudited interim financial statements (including, in each case, the notes and schedules thereto) included in the Acquiror SEC Reports complied as to form in all material respects with the published rules and regulations of the SEC with respect thereto, were prepared in accordance with GAAP applied on a consistent basis during the periods involved (except as may be indicated therein or in the notes thereto and except with respect to unaudited statements as permitted by Form 10-Q of the SEC), and fairly present (subject, in the case of the unaudited interim financial statements included therein, to normal year-end adjustments and the absence of complete footnotes) in all material respects the financial position of Acquiror as of the respective dates thereof and the results of their operations and cash flows for the respective periods then ended.

(b) Acquiror has established and maintains disclosure controls and procedures (as defined in Rule 13a-15 under the Exchange Act). Such disclosure controls and procedures are designed to ensure that material information relating to Acquiror and other material information required to be disclosed by Acquiror in the reports and other documents that it files or furnishes under the Exchange Act is recorded, processed, summarized and reported within the time periods specified in the rules and forms of the SEC, and that all such material information is accumulated and communicated to Acquiror's principal executive officer and its principal financial officer as appropriate to allow timely decisions regarding required disclosure and to make the certifications required pursuant to Sections 302 and 906 of the Sarbanes-Oxley Act. Such disclosure controls and procedures are effective in timely alerting Acquiror's principal executive officer and principal financial officer to material information required to be included in Acquiror's periodic reports required under the Exchange Act.

[Table of Contents](#)

(c) Acquiror has established and maintained a system of internal controls. Such internal controls are sufficient to provide reasonable assurance regarding the reliability of Acquiror's financial reporting and the preparation of Acquiror's financial statements for external purposes in accordance with GAAP.

(d) There are no outstanding loans or other extensions of credit made by Acquiror to any executive officer (as defined in Rule 3b-7 under the Exchange Act) or director of Acquiror. Acquiror has not taken any action prohibited by Section 402 of the Sarbanes-Oxley Act.

(e) Neither Acquiror (including any employee thereof) nor Acquiror's independent auditors has identified or been made aware of (i) any significant deficiency or material weakness in the system of internal accounting controls utilized by Acquiror, (ii) any fraud, whether or not material, that involves Acquiror's management or other employees who have a role in the preparation of financial statements or the internal accounting controls utilized by Acquiror or (iii) any claim or allegation regarding any of the foregoing.

(f) As of the date hereof, there are no outstanding SEC comments from the SEC with respect to the Acquiror SEC Reports. None of the Acquiror SEC Reports filed on or prior to the date hereof is subject to ongoing SEC review or investigation as of the date hereof.

5.12 Business Activities; Absence of Changes.

(a) Since its incorporation, Acquiror has not conducted any business activities other than activities directed toward the accomplishment of a Business Combination. Except as set forth in the Acquiror Organizational Documents, there is no agreement, commitment or Governmental Order binding upon Acquiror or to which Acquiror is a party which has had or would reasonably be expected to have the effect of prohibiting or impairing any business practice of Acquiror or any acquisition of property by Acquiror or the conduct of business by Acquiror as currently conducted or as contemplated to be conducted as of the Closing other than such effects, individually or in the aggregate, which have not had and would not reasonably be expected to have a material adverse effect on the ability of Acquiror or Merger Sub to enter into and perform its obligations under this Agreement and consummate the Transactions.

(b) Acquiror does not own or have a right to acquire, directly or indirectly, any interest or investment (whether equity or debt) in any corporation, partnership, joint venture, business, trust or other entity. Except for this Agreement and the Transactions, Acquiror has no interests, rights, obligations or liabilities with respect to, and is not party to, bound by or has its assets or property subject to, in each case whether directly or indirectly, any Contract or transaction which is, or could reasonably be interpreted as constituting, a Business Combination.

(c) Except for (i) this Agreement and the agreements expressly contemplated hereby (including any agreements permitted by [Section 7.01](#)) and (ii) with respect to fees and expenses of Acquiror's legal, financial and other advisors, Acquiror is not, and at no time has been, party to any Contract with any other Person that would require payments by Acquiror in excess of \$150,000 monthly, \$250,000 in the aggregate annually with respect to any individual Contract or more than \$500,000 in the aggregate annually when taken together with all other Contracts (other than this Agreement and the agreements expressly contemplated hereby (including any agreements permitted by [Section 7.01](#))).

(d) There is no liability, debt or obligation against Acquiror or its Subsidiaries, except for liabilities and obligations (i) reflected or reserved for on Acquiror's consolidated balance sheet for the quarterly period ended September 30, 2021 or disclosed in the notes thereto (other than any such liabilities not reflected, reserved or disclosed as are not and would not be, in the aggregate, material to Acquiror and its Subsidiaries, taken as a whole) or (ii) that have arisen since the date of Acquiror's consolidated balance sheet for the quarterly period September 30, 2021 in the ordinary course of the operation of business of Acquiror and its Subsidiaries (other than any such liabilities as are not and would not be, in the aggregate, material to Acquiror and its Subsidiaries, taken as a whole).

(e) Since its organization, Merger Sub has not conducted any business activities other than activities directed toward the accomplishment of the Merger. Except as set forth in Merger Sub's organizational documents, there is no agreement, commitment, or Governmental Order binding upon Merger Sub or to which Merger Sub is a party which has had or would reasonably be expected to have the effect of prohibiting or impairing any business practice of Merger Sub or any acquisition of property by Merger Sub or the conduct of business by Merger Sub as currently conducted or as contemplated to be conducted as of the Closing other than such effects, individually or in the aggregate, which have not had and would not reasonably be expected to have a material adverse effect on the ability of Merger Sub to enter into and perform its obligations under this Agreement.

[Table of Contents](#)

(f) Merger Sub does not own or have a right to acquire, directly or indirectly, any interest or investment (whether equity or debt) in any corporation, partnership, joint venture, business, trust or other entity.

(g) Merger Sub was formed solely for the purpose of effecting the Merger and has not engaged in any business activities or conducted any operations other than in connection with the Merger and has no, and at all times prior to the Effective Time except as contemplated by this Agreement or the Ancillary Agreements to this Agreement, will have no, assets, liabilities or obligations of any kind or nature whatsoever other than those incident to its formation.

(h) Since the date of Acquiror's formation through and including the date of this Agreement, (i) there has not been any change, development, condition, occurrence, event or effect relating to the Acquiror or its Subsidiaries that, individually or in the aggregate, resulted in, or would reasonably be expected to result in, a material adverse effect on the ability of Acquiror or Merger Sub to enter into and perform its obligations under this Agreement and consummate the Transactions and (ii) Acquiror and its Subsidiaries have not taken any action that would require the consent of the Company pursuant to [Section 7.01](#) if such action had been taken after the date of this Agreement.

5.13 [Registration Statement](#). As of the time the Registration Statement becomes effective under the Securities Act, the Registration Statement (together with any amendments or supplements thereto) will not contain any untrue statement of a material fact or omit to state a material fact necessary to make the statements therein, in the light of the circumstances under which they were made, not misleading; [provided, however](#), that Acquiror makes no representations or warranties as to the information contained in or omitted from the Registration Statement in reliance upon and in conformity with information furnished in writing to Acquiror by or on behalf of the Company specifically for inclusion in the Registration Statement.

5.14 [No Outside Reliance](#). Notwithstanding anything contained in this [Article V](#) or any other provision hereof, Acquiror and Merger Sub and its other Affiliates and any of its and their respective directors, officers, employees, stockholders, partners, members or Representatives, acknowledge and agree that Acquiror and Merger Sub have made their own investigation of the Company and that they are relying only on that investigation and the specific representations and warranties set forth in this Agreement, and not on any other representation or statement made by the Company nor any of its Affiliates or any of their respective directors, officers, employees, stockholders, partners, members, agents or Representatives, and that none of such persons is making or has made any representation or warranty whatsoever, express or implied, other than those expressly given by the Company in [Article IV](#), including without limitation any other implied warranty or representation as to condition, merchantability, suitability or fitness for a particular purpose or trade as to any of the assets of the Company. Without limiting the generality of the foregoing, it is understood that any cost estimates, financial or other projections or other predictions that may be contained or referred to in the Acquiror and Merger Sub Schedules or elsewhere, as well as any information, documents or other materials (including any such materials contained in any "data room" (whether or not accessed by Acquiror or its representatives) or reviewed by Acquiror and Merger Sub pursuant to the Confidentiality Agreement) or management presentations that have been or shall hereafter be provided to Acquiror or any of its Affiliates, agents or representatives are not and will not be deemed to be representations or warranties of the Company, and no representation or warranty is made as to the accuracy or completeness of any of the foregoing except as may be expressly set forth in [Article IV](#) of this Agreement. Except as otherwise expressly set forth in this Agreement, Acquiror understands and agrees that any assets, properties and business of the Company are furnished "as is", "where is" and subject to and except as otherwise provided in the representations and warranties of the Company expressly set forth in [Article IV](#) or any certificate delivered in accordance with [Section 9.02\(c\)](#), with all faults and without any other representation or warranty of any nature whatsoever.

5.15 [Capitalization](#).

(a) As of the date of this Agreement, the authorized capital stock of the Acquiror consists of 200,000,000 shares of Common Stock, par value \$0.0001 per share and 1,000,000 shares of preferred stock, par value \$0.0001 per share, of which 21,562,500 shares of Common Stock are issued and outstanding as of the date hereof and no preferred shares are issued and outstanding. 15,799,995 shares of Common Stock are reserved for issuance upon the exercise of the Acquiror Warrants. All of the issued and outstanding shares of Acquiror Common Stock and Acquiror Warrants (including the shares of Acquiror Common Stock underlying the Acquiror Warrants) (i) have been duly authorized and validly issued and are fully paid and nonassessable, (ii) were issued in compliance in all material respects with applicable Law, (iii) were not issued in breach or violation of any preemptive rights or Contract and (iv) are fully vested and not otherwise subject to a substantial risk of forfeiture within the meaning of Code Section 83.

(b) Except for this Agreement and the Acquiror Warrants there are (i) no subscriptions, calls, options, warrants, rights or other securities convertible into or exchangeable or exercisable for shares of Acquiror Common Stock or any other equity interests of Acquiror, or any other Contracts to which Acquiror is a party or by which Acquiror is bound obligating (or in lieu of a cash payment, allowing) Acquiror to issue or sell any shares of capital stock of, other equity interests in or debt securities of, Acquiror, and (ii) no equity equivalents, stock appreciation rights, phantom stock ownership interests or similar rights in Acquiror. Except as otherwise required by Acquiror's Organizational Documents in order to consummate the transactions contemplated hereby, there are no outstanding contractual obligations of Acquiror to repurchase, redeem or otherwise acquire any securities or equity interests of Acquiror. There are no outstanding bonds, debentures, notes or other indebtedness of Acquiror having the right to vote (or convertible into, or exchangeable for, securities having the right to vote) on any matter for which Acquiror's stockholders may vote. Acquiror is not a party to any shareholders' agreement, voting agreement or registration rights agreement relating to Acquiror Common Stock or any other equity interests of Acquiror. Acquiror does not own any capital stock or any other equity interests in any other Person or has any right, option, warrant, conversion right, stock appreciation right, redemption right, repurchase right, agreement, arrangement or commitment of any character under which a Person is or may become obligated to issue or sell, or give any right to subscribe for or acquire, or in any way dispose of, any shares of the capital stock or other equity interests, or any securities or obligations exercisable or exchangeable for or convertible into any shares of the capital stock or other equity interests, of such Person. There are no securities or instruments issued by or to which Acquiror is a party containing anti-dilution or similar provisions that will be triggered by the consummation of the Transactions, in each case, that have not been, or will not be, waived on or prior to the Closing Date.

(c) As of the date hereof, the authorized share capital of Merger Sub consists of 100 shares of common stock, par value \$0.01 per share, of which 10 shares are issued and outstanding and beneficially held (and held of record) solely by Acquiror as of the date of this Agreement.

5.16 Nasdaq Stock Market Listing. The Acquiror Units, the Acquiror Public Warrants and the issued and outstanding shares of Acquiror Common Stock are registered pursuant to Section 12(b) of the Exchange Act and are listed for trading on Nasdaq under the symbols "CLAQU" (with respect to the Acquiror Units), "CLAQ" (with respect to the Acquiror Common Stock), "CLAQR" (with respect to the Acquiror Rights), and "CLAQW" (with respect to the Acquiror Public Warrants). Acquiror is in compliance in all material respects with the rules of the Nasdaq and there is no action or proceeding pending or, to the knowledge of Acquiror, threatened against Acquiror by Nasdaq, the Financial Industry Regulatory Authority or the SEC with respect to any intention by such entity to deregister the Acquiror Units, the Acquiror Common Stock or the Acquiror Public Warrants or terminate the listing of such on Nasdaq. None of Acquiror or its Affiliates has taken any action in an attempt to terminate the registration of the Acquiror Units, the Acquiror Common Stock or the Acquiror Public Warrants under the Exchange Act.

5.17 Contracts: No Defaults.

(a) Schedule 5.17 contains a listing of all Contracts including every "material contract" (as such term is defined in Item 601(b)(10) of Regulation S-K of the SEC) (other than confidentiality and non-disclosure agreements and this Agreement) to which, as of the date of this Agreement, Acquiror or one or more of its Subsidiaries is a party or by which any of their respective assets are bound. True, correct and complete copies of the Contracts listed on Schedule 5.17 have been delivered to or made available to the Company or its agents or representatives.

(b) Each Contract of a type required to be listed on Schedule 5.17, whether or not set forth on Schedule 5.17, was entered into at arm's length and in the ordinary course of business. Except for any Contract that has terminated or will terminate upon the expiration of the stated term thereof prior to the Closing Date, with respect to any Contract of the type described in Section 5.17(a), whether or not set forth on Schedule 5.17, (i) such Contracts are in full force and effect and represent the legal, valid and binding obligations of Acquiror or its Subsidiaries party thereto and, to the knowledge of Acquiror, represent the legal, valid and binding obligations of the other parties thereto, and, to the knowledge of Acquiror, are enforceable by Acquiror or its Subsidiaries to the extent a party thereto in accordance with their terms, subject in all respects to the effects of bankruptcy, insolvency, fraudulent conveyance, reorganization, moratorium and other laws relating to or affecting creditors' rights generally and general equitable principles (whether considered in a proceeding in equity or at law), (ii) none of Acquiror, its Subsidiaries or, to the knowledge of Acquiror, any other party thereto is in material breach of or material default (or would be in material breach, violation or default but for the existence of a cure period) under any such Contract, (iii) since the dates of their respective incorporations, neither Acquiror nor its Subsidiaries have received any written or, to

[Table of Contents](#)

the knowledge of Acquiror, oral claim or notice of material breach of or material default under any such Contract, (iv) to the knowledge of Acquiror, no event has occurred which, individually or together with other events, would reasonably be expected to result in a material breach of or a material default under any such Contract by Acquiror or its Subsidiaries or, to the knowledge of Acquiror, any other party thereto (in each case, with or without notice or lapse of time or both) and (v) since the dates of their respective incorporations, through the date hereof, neither Acquiror nor its Subsidiaries have received written notice from any other party to any such Contract that such party intends to terminate or not renew any such Contract.

5.18 Title to Property. Neither Acquiror nor any of its Subsidiaries (a) owns or leases any real or personal property or (b) is a party to any agreement or option to purchase any real property, personal property or other material interest therein.

5.19 Investment Company Act. Neither Acquiror nor any of its Subsidiaries is an “investment company” within the meaning of the Investment Company Act of 1940, as amended.

5.20 Affiliate Agreements. None of Acquiror or its Subsidiaries is a party to any transaction, agreement, arrangement or understanding with any (i) present or former executive officer or director of any of Acquiror or its Subsidiaries, (ii) beneficial owner (within the meaning of Section 13(d) of the Exchange Act) of 5% or more of the capital stock or equity interests of any of the Company or (iii) Affiliate, “associate” or member of the “immediate family” (as such terms are respectively defined in Rules 12b-2 and 16a-1 under the Exchange Act) of any of the foregoing (each of the foregoing, an “Acquiror Affiliate Agreement”).

5.21 Sponsor Support Agreement. Acquiror has delivered to the Company a true, correct and complete copy of the Sponsor Support Agreement. The Sponsor Support Agreement is in full force and effect and has not been withdrawn or terminated, or otherwise amended or modified, in any respect, and no withdrawal, termination, amendment or modification is contemplated by Acquiror. The Sponsor Support Agreement is a legal, valid and binding obligation of Acquiror and, to the knowledge of Acquiror, each other party thereto and neither the execution or delivery by any party thereto of, nor the performance of any party’s obligations under, the Sponsor Support Agreement violates any provision of, or results in the breach of or default under, or requires any filing, registration or qualification under, any applicable Law. No event has occurred that, with or without notice, lapse of time or both, would constitute a default or breach on the part of Acquiror under any term or condition of the Sponsor Support Agreement.

**ARTICLE VI
COVENANTS OF THE COMPANY**

6.01 Conduct of Business. From the date of this Agreement until the earlier of the Closing Date or the termination of this Agreement in accordance with its terms (the “Interim Period”), the Company shall, except (1) as contemplated by the Transaction Finance Loans, (2) as contemplated by the Company Convertible Notes, (3) as set forth on Schedule 6.01, (4) as expressly contemplated by this Agreement, (5) as consented to by Acquiror in writing (which consent shall not be unreasonably conditioned, withheld or delayed), or (6) as may be required by Law, (i) use commercially reasonable efforts to conduct and operate its business in the ordinary course, and to preserve intact the current business organization and ongoing businesses of the Company, and maintain the existing relations and goodwill of the Company with customers, suppliers, joint venture partners, distributors and creditors of the Company, and (ii) use commercially reasonable efforts to maintain all insurance policies of the Company or substitutes therefor. Without limiting the generality of the foregoing, except as set forth on Schedule 6.01, as expressly contemplated by this Agreement or as consented to by Acquiror in writing (which consent shall not be unreasonably conditioned, withheld or delayed), or as may be required by Law, the Company shall not, during the Interim Period, except (1) as contemplated by the Transaction Finance Loans, (2) as contemplated by the Company Convertible Notes or (3) as otherwise contemplated by this Agreement:

(a) change or amend the certificate of formation or the bylaws of the Company;

(b) (i) make, declare or pay any dividend or distribution (whether in cash, stock or property) to the stockholders of the Company in their capacities as stockholders, (ii) effect any recapitalization, reclassification, split or other change in its capitalization, or (iii) except pursuant to the Company Stock Plan or related Company Options, issue, repurchase, redeem or otherwise acquire, or offer to repurchase, redeem or otherwise acquire, any shares of its capital stock or other equity interests;

[Table of Contents](#)

(c) except as set forth on Schedule 6.01(c), enter into, or amend or modify any material term of (in a manner adverse to the Company), terminate (excluding any expiration in accordance with its terms), or waive or release any material rights, claims or benefits under, any Material Contract (or any Contract, that if existing on the date hereof, would have been a Material Contract), any Real Estate Lease Document related to the Leased Real Property or any collective bargaining or similar agreement (including agreements with works councils and trade unions and side letters) to which the Company is a party or by which it is bound, other than entry into, amendments of, modifications of, terminations of, or waivers or releases under, such agreements in the ordinary course of business;

(d) sell, transfer, license, sublicense, covenant not to assert, lease, pledge or otherwise encumber or subject to any Lien, abandon, cancel, let lapse or convey or dispose of any assets, properties or business of the Company (including Owned Intellectual Property and Owned Company Software), except for (i) dispositions of obsolete or worthless assets, (ii) sales of tangible inventory in the ordinary course of business and (iii) sales, abandonment, lapses of tangible assets or tangible items or tangible materials in an amount not in excess of \$500,000 in the aggregate, other than (1) Permitted Liens or (2) pledges and encumbrances on property and assets in the ordinary course of business and that would not, individually or in the aggregate, reasonably be expected to have a Material Adverse Effect;

(e) except as set forth on Schedule 6.01(e) or otherwise required pursuant to Company Benefit Plans, in effect on the date of this Agreement, applicable Law, or policies or Contracts of the Company in effect on the date of this Agreement, (i) grant any material increase in compensation, benefits or severance to any employee, director or service provider of the Company other than any such individual with an annual base salary of less than \$175,000, (ii) adopt, enter into or materially amend any Company Benefit Plan, or any collective bargaining or similar agreement (including agreements with works councils and trade unions and side letters) to which the Company is a party or by which it is bound, (iii) grant or provide any severance, termination payments, bonus, change of control, retention, or benefits to any employee of the Company, except in connection with the promotion or hiring (to the extent permitted by clause (iv) of this paragraph) or separation of any employee in the ordinary course of business or the firing of any employee, (iv) hire any employee of the Company or any other individual who is providing or will provide services to the Company other than any employee with an annual base salary of less than \$175,000 (except to replace terminated employees) in the ordinary course of business, (v) adopt, enter into or materially amend Contracts with any consultants or independent contractors that involve consideration of more than \$250,000 in the aggregate or (vi) take any action to accelerate the vesting, payment or funding of any cash compensation, payment or benefit;

(f) (i) fail to maintain its existence or acquire by merger or consolidation with, or merge or consolidate with, or purchase a material portion of the assets or equity of, any corporation, partnership, limited liability company, association, joint venture or other business organization or division thereof; or (ii) adopt or enter into a plan of complete or partial liquidation, dissolution, merger, consolidation, restructuring, recapitalization or other reorganization of the Company (other than the transactions contemplated by this Agreement);

(g) make any capital expenditures (or commitment to make any capital expenditures) that in the aggregate exceed \$1,000,000, other than any capital expenditure (or series of related capital expenditures) consistent in all material respects with the Company's annual capital expenditure budget for periods following the date hereof, made available to Acquiror or any capitalized Contract costs associated with new or existing customers;

(h) make any loans, advances or capital contributions to, or investments in, any other Person (including to any of its officers, directors, agents or consultants), make any material change in its existing borrowing or lending arrangements for or on behalf of such Persons, or enter into any "keep well" or similar agreement to maintain the financial condition of any other Person, except advances to directors, employees or officers of the Company in the ordinary course of business or as required under any provisions of the Company Certificate of Incorporation, the bylaws of the Company or any indemnification agreement to which the Company is a party, in each case as in effect as of the date hereof;

(i) make, revoke or change any material Tax election, adopt or change any material Tax accounting method or period, file any amendment to a material Tax Return, enter into any agreement with a Governmental Authority with respect to a material amount of Taxes, settle or compromise any examination, audit or other Action with a Governmental Authority of or relating to any material Taxes or settle or compromise any claim or assessment by a Governmental Authority in respect of material Taxes, consent to any extension or waiver of the statutory period of limitations applicable to any claim or assessment in respect of Taxes, or enter into any Tax sharing or similar agreement (excluding any commercial contract not primarily related to Taxes);

[Table of Contents](#)

(j) take any action, or knowingly fail to take any action, which action or failure to act would reasonably be expected to prevent or impede the Transactions from qualifying for the Intended Tax Treatment;

(k) acquire any fee interest in real property;

(l) enter into, renew or amend in any material respect any Company Affiliate Agreement;

(m) waive, release, compromise, settle or satisfy any pending or threatened material claim (which shall include, but not be limited to, any pending or threatened Action) or compromise or settle any liability, other than in the ordinary course of business or that otherwise do not exceed \$500,000 in the aggregate;

(n) incur, create, assume, refinance, guarantee or otherwise become liable for (whether directly, contingently or otherwise) any Indebtedness in excess of \$1,000,000, other than in connection with borrowings, extensions of credit and other financial accommodations under the Company's existing credit facilities, notes and other existing Indebtedness and, in each case, any refinancings thereof, provided, that, in no event shall any such borrowing, extension of credit or other financial accommodation be subject to any prepayment fee or penalty or similar arrangement or amend, restate or modify in a manner materially adverse to the Company any terms of or any agreement with respect to any such outstanding Indebtedness (when taken as a whole); provided, further, that any action permitted under this [Section 6.01\(n\)](#) shall be deemed not to violate [Section 6.01\(b\)](#) or [Section 6.01\(c\)](#);

(o) enter into any material new line of business outside of the business currently conducted by the Company as of the date of this Agreement (it being understood that this [Section 6.01\(o\)](#) shall not restrict the Company from extending its business into new geographies);

(p) make any material change in financial accounting methods, principles or practices, except insofar as may have been required by a change in GAAP (including pursuant to standards, guidelines and interpretations of the Financial Accounting Standards Board or any similar organization) or applicable Law;

(q) enter into, renew or amend in any material respect, any Company Affiliate Agreement (or any Contract, that if existing on the date hereof, would have constituted a Company Affiliate Agreement);

(r) (i) disclose any source code for any Owned Company Software or any other material Trade Secrets to any Person (other than pursuant to a written agreement sufficient to protect the confidentiality thereof) or (ii) subject any Owned Intellectual Property or Owned Company Software to Copyleft Terms; and

(s) enter into any agreement to do any action prohibited under this [Section 6.01](#).

6.02 Inspection. Subject to confidentiality obligations and similar restrictions that may be applicable to information furnished to the Company by third parties that may be in the Company's possession from time to time, and except for any information which (x) relates to interactions with prospective buyers of the Company or the negotiation of this Agreement and the transactions contemplated hereby or (y) in the judgment of legal counsel of the Company would result in the loss of attorney-client privilege or other privilege from disclosure or would conflict with any applicable Law or confidentiality obligations to which the is bound, the Company shall afford to Acquiror and its Representatives reasonable access during the Interim Period, during normal business hours and with reasonable advance notice, in such manner as to not interfere with the normal operation of the Company, to all of its properties, books, projections, plans, systems, Contracts, commitments, Tax Returns, records, commitments and analyses and, as reasonably requested by Acquiror or its Representatives, appropriate officers and employees of the Company, and shall furnish such Representatives with all financial and operating data and other information concerning the affairs of the Company that are in the possession of the Company as such Representatives may reasonably request, in each case, as necessary to facilitate consummation of the transactions contemplated by this Agreement; provided, however, that (i) such access may be modified to the extent the Company reasonably determines, in light of COVID-19 or COVID-19 Measures, that such access would jeopardize the health and safety of any employee of the Company and (ii) nothing in this Agreement shall be deemed to provide Acquiror and its Representatives with the right to have access to any of the offices or information of any of the equityholders of the Company, that is not otherwise related to the Company or the transactions contemplated by this Agreement or any Ancillary Agreement. Acquiror hereby agrees that, during the Interim Period, (x) it shall not contact any employee (excluding executive officers), customer, supplier, distributor or other material business relation of the Company or (y) conduct or perform any invasive or subsurface investigations of the properties or facilities of the Company or its Affiliates, in each case, without the prior written consent of the

[Table of Contents](#)

Company. The parties shall use commercially reasonable efforts to make alternative arrangements for such disclosure where the restrictions in the preceding sentence apply. All information obtained by Acquiror and its Representatives under this Agreement shall be subject to the Confidentiality Agreement prior to the Effective Time.

6.03 No Acquiror Common Stock Transactions. From and after the date of this Agreement until the Effective Time, except as otherwise contemplated by this Agreement, the Company shall not engage in any transactions involving the securities of Acquiror without the prior consent of Acquiror if the Company possesses material nonpublic information of the Acquiror.

6.04 No Claim Against the Trust Account. The Company acknowledges that Acquiror is a special purpose acquisition company with the power and privileges to effect a merger, asset acquisition, reorganization or similar business combination involving the Company and one or more businesses or assets, and the Company has read Acquiror's final prospectus, dated July 16, 2021, and other Acquiror SEC Reports, the Acquiror Organizational Documents, and the Trust Agreement and understands that Acquiror has established the Trust Account described therein for the benefit of Acquiror's public stockholders and that disbursements from the Trust Account are available only in the limited circumstances set forth therein. The Company further acknowledges and agrees that Acquiror's sole assets consist of the cash proceeds of Acquiror's initial public offering and private placements of its securities, and that substantially all of these proceeds have been deposited in the Trust Account for the benefit of its public shareholders. The Company further acknowledges that, if the transactions contemplated by this Agreement are not consummated by July 19, 2022, or such later date as approved by the shareholders of Acquiror to complete a Business Combination, Acquiror will be obligated to return to its stockholders the amounts being held in the Trust Account. Accordingly, the Company (on behalf of itself and its Affiliates) hereby waives any past, present or future claim of any kind against, and any right to access, the Trust Account, any trustee of the Trust Account and Acquiror to collect from the Trust Account any monies that may be owed to them by Acquiror or any of its Affiliates for any reason whatsoever, and will not seek recourse against the Trust Account at any time for any reason whatsoever. This Section 6.04 shall survive the termination of this Agreement for any reason.

6.05 Proxy Solicitation; Other Actions.

(a) The Company has provided to Acquiror, for inclusion in the Registration Statement, to be filed by Acquiror hereunder, the audited financial statements, including balance sheets, statements of operations, statements of redeemable preferred stock and stockholders' deficit and statements of cash flows as of and for the years ended December 31, 2019 and 2020, and the unaudited financial statements including balance sheets, statements of operations, statements of redeemable preferred stock and stockholders' deficit and statements of cash flows as of and for the nine-month period ended September 30, 2021, in each case, prepared in accordance with GAAP and Regulation S-X under the Securities Act (except (x) as otherwise noted therein to the extent permitted by Regulation S-X under the Securities Act, and, in the case of such audited financial statements, audited in accordance with PCAOB auditing standards by a PCAOB qualified auditor and (y) in the case of the unaudited financial statements, subject to normal and recurring year-end adjustments and the absence of notes thereto). The Company shall be available to, and the Company shall use reasonable best efforts to make its officers and employees available to, in each case, during normal business hours and upon reasonable advanced notice, Acquiror and its counsel in connection with responding in a timely manner to comments on the Registration Statement from the SEC.

(b) From and after the date on which the Registration Statement becomes effective under the Securities Act, the Company will give Acquiror prompt written notice of any action taken or not taken by the Company or of any development regarding the Company, in any such case which, to the knowledge of the Company, would cause the Registration Statement to contain an untrue statement of a material fact or omit to state a material fact necessary in order to make the statements, in light of the circumstances under which they were made, not misleading; provided that, if any such action shall be taken or fail to be taken or such development shall otherwise occur, Acquiror and the Company shall cooperate fully to cause an amendment or supplement to be made promptly to the Registration Statement, such that the Registration Statement no longer contains an untrue statement of a material fact or omit to state a material fact necessary in order to make the statements, in light of the circumstances under which they were made, not misleading; provided further, however, that no information received by Acquiror pursuant to this Section 6.05 shall operate as a waiver or otherwise affect any representation, warranty or agreement given or made by the party who disclosed such information, and no such information shall be deemed to change, supplement or amend the Company Schedules.

**ARTICLE VII
COVENANTS OF ACQUIROR**

7.01 Conduct of Acquiror During the Interim Period.

(a) During the Interim Period, except as set forth on Schedule 7.01 or as expressly contemplated by this Agreement or as consented to by the Company in writing (which consent shall not be unreasonably conditioned, withheld or delayed), Acquiror shall not and each shall not permit any of its Subsidiaries to:

(i) change, modify or amend the Trust Agreement, the Acquiror Organizational Documents or the organizational documents of Merger Sub;

(ii) (A) make, declare, set aside or pay any dividends on, or make any other distribution (whether in cash, stock or property) in respect of any of its outstanding capital stock or other equity interests; (B) split, combine, reclassify, subdivide or otherwise change any of its capital stock or other equity interests; or (C) other than the redemption of any shares of Acquiror Common Stock required by the Offer, repurchase, redeem or otherwise acquire, or offer to repurchase, redeem or otherwise acquire, any capital stock of, or other equity interests in, Acquiror;

(iii) make, revoke or change any material Tax election, adopt or change any material Tax accounting method or period, file any amendment to a material Tax Return, enter into any agreement with a Governmental Authority with respect to a material amount of Taxes, settle or compromise any examination, audit or other Action with a Governmental Authority of or relating to any material Taxes or settle or compromise any claim or assessment by a Governmental Authority in respect of material Taxes, consent to any extension or waiver of the statutory period of limitations applicable to any claim or assessment in respect of Taxes, or enter into any Tax sharing or similar agreement (excluding any commercial contract not primarily related to Taxes);

(iv) take any action, or knowingly fail to take any action, which action or failure to act could reasonably be expected to prevent or impede the Transactions from qualifying for the Intended Tax Treatment;

(v) except for Working Capital Loans, enter into, renew or amend in any material respect, any Acquiror Affiliate Agreement (or any Contract, that if existing on the date hereof, would have constituted an Acquiror Affiliate Agreement);

(vi) except for Working Capital Loans, enter into, or amend or modify any material term of (in a manner adverse to Acquiror or any of its Subsidiaries, including the Company), terminate excluding any expiration in accordance with its terms, or waive or release any material rights, claims or benefits under, any Contract of a type required to be listed on Schedule 5.17 (or any Contract, that if existing on the date hereof, would have been required to be listed on Schedule 5.17) or any collective bargaining or similar agreement (including agreements with works councils and trade unions and side letters) to which Acquiror or its Subsidiaries is a party or by which it is bound;

(vii) waive, release, compromise, settle or satisfy any pending or threatened claim (which shall include, but not be limited to, any pending or threatened Action) or compromise or settle any liability;

(viii) except for Working Capital Loans, incur, create, assume, refinance, guarantee or otherwise become liable for (whether directly, contingently or otherwise) any Indebtedness;

(ix) (A) other than pursuant to the Subscription Agreements, offer, issue, deliver, grant or sell, or authorize or propose to offer, issue, deliver, grant or sell, any capital stock of, or other equity interests in, Acquiror or any of its Subsidiaries or any securities convertible into, or any rights, warrants or options to acquire, any such capital stock or equity interests, other than in connection with the exercise of any Acquiror Warrants outstanding on the date hereof, (B) amend, modify or waive any of the terms or rights set forth in, any warrant agreement with respect to Acquiror Warrants,

including any amendment, modification or reduction of the warrant price set forth therein, (C) enter into any new Subscription Agreements or other agreements that contemplate Equity Financing, or (D) consummate the Equity Financing on terms materially different than those contained in such Subscription Agreements;

(x) except as contemplated by the Acquiror Incentive Plan Proposal, (i) adopt or amend any Acquiror Benefit Plan, or enter into any employment contract or collective bargaining agreement or (ii) hire any employee of Acquiror or its Subsidiaries or any other individual who is providing or will provide services to Acquiror or its Subsidiaries;

(xi) (i) fail to maintain its existence or acquire by merger or consolidation with, or merge or consolidate with, or purchase the assets or equity of, any corporation, partnership (limited or general), limited liability company, association, joint venture or other business organization or division thereof; or (ii) adopt or enter into a plan of complete or partial liquidation, dissolution, merger, consolidation, restructuring, recapitalization or other reorganization of Acquiror or its Subsidiaries (other than the transactions contemplated by this Agreement);

(xii) make any capital expenditures;

(xiii) make any loans, advances or capital contributions to, or investments in, any other Person (including to any of its officers, directors, agents or consultants), make any change in its existing borrowing or lending arrangements for or on behalf of such Persons, or enter into any "keep well" or similar agreement to maintain the financial condition of any other Person;

(xiv) enter into any new line of business outside of the business currently conducted by Acquiror and its Subsidiaries as of the date of this Agreement;

(xv) make any change in financial accounting methods, principles or practices, except insofar as may have been required by a change in GAAP, including pursuant to standards, guidelines and interpretations of the Financial Accounting Standards Board or any similar organization, or applicable Law;

(xvi) voluntarily fail to maintain, cancel or materially change coverage under any insurance policy in form and amount equivalent in all material respects to the insurance coverage currently maintained with respect to Acquiror and its Subsidiaries and their assets and properties; or

(xvii) enter into any agreement to do any action prohibited under this [Section 7.01](#).

(b) During the Interim Period, Acquiror shall, and shall cause its Subsidiaries to comply with, and continue performing under, as applicable, the Acquiror Organizational Documents, the Trust Agreement and all other agreements or Contracts to which Acquiror or its Subsidiaries may be a party.

7.02 Trust Account. Prior to or at the Closing (subject to the satisfaction or waiver of the conditions set forth in [Article IX](#)), Acquiror shall make appropriate arrangements to cause the funds in the Trust Account to be disbursed in accordance with the Trust Agreement, and the funds received in the Equity Financing to be disbursed, for the following uses: (a) the redemption of any shares of Acquiror Common Stock in connection with the Offer; (b) the payment of the Outstanding Company Expenses and Outstanding Acquiror Expenses pursuant to [Section 3.09](#); and (c) the balance after payment and disbursement of the amounts required under the foregoing clauses (a) and (b) to be disbursed to PubCo.

7.03 Inspection. Subject to confidentiality obligations and similar restrictions that may be applicable to information furnished to Acquiror or its Subsidiaries by third parties that may be in Acquiror's or its Subsidiaries' possession from time to time, and except for any information which in the opinion of legal counsel of Acquiror would result in the loss of attorney-client privilege or other privilege from disclosure or would conflict with any applicable Law or confidentiality obligations to which Acquiror or any of its Subsidiaries is bound, Acquiror shall afford to the Company, its Affiliates and their respective Representatives reasonable access during the Interim Period, during normal business hours and with reasonable advance notice, to all of their respective properties, books, projections, plans, systems, Contracts, commitments, Tax Returns, records, commitments, analyses and appropriate officers and employees of Acquiror, and shall furnish such Representatives with all financial and operating data and other information concerning the affairs

[Table of Contents](#)

of Acquiror that are in the possession of Acquiror as such Representatives may reasonably request. The parties shall use commercially reasonable efforts to make alternative arrangements for such disclosure where the restrictions in the preceding sentence apply. All information obtained by the Company, its Affiliates and their respective Representatives under this Agreement shall be subject to the Confidentiality Agreement prior to the Effective Time.

7.04 Acquiror Nasdaq Listing.

(a) From the date hereof through the Closing, Acquiror shall use reasonable best efforts to ensure Acquiror remains listed as a public company on, and for shares of Acquiror Common Stock to be listed on, Nasdaq.

(b) Acquiror shall use reasonable best efforts to cause the PubCo's Common Stock to be issued in connection with the Transactions (including the Earnout Shares) to be approved for listing on Nasdaq as promptly as practicable following the issuance thereof, subject to official notice of issuance, prior to the Closing Date.

7.05 Acquiror Public Filings. From the date hereof through the Closing, Acquiror will use reasonable best efforts to keep current and file all reports required to be filed or furnished with the SEC and otherwise comply in all material respects with its reporting obligations under applicable Securities Laws.

7.06 Section 16 Matters. Prior to the Closing, the Acquiror Board, or an appropriate committee of "non-employee directors" (as defined in Rule 16b-3 under the Exchange Act) thereof, shall adopt a resolution consistent with the interpretive guidance of the SEC so that the acquisition of Acquiror Common Stock pursuant to this Agreement (including the Earnout Shares) and the other agreements contemplated hereby, by any person owning securities of the Company who is expected to become a director or officer (as defined under Rule 16a-1(f) under the Exchange Act) of Acquiror following the Closing shall be an exempt transaction for purposes of Section 16(b) of the Exchange Act pursuant to Rule 16b-3 thereunder.

7.07 Exclusivity. During the Interim Period, Acquiror shall not take, nor shall it permit any of its Affiliates or Representatives to take, whether directly or indirectly, any action to solicit, initiate, continue or engage in discussions or negotiations with, or enter into any agreement with, or encourage, respond, provide information to or commence due diligence with respect to, any Person (other than the Company, its shareholders and/or any of their Affiliates or Representatives), concerning, relating to or which is intended or is reasonably likely to give rise to or result in, any offer, inquiry, proposal or indication of interest, written or oral relating to any Business Combination (a "Business Combination Proposal") other than with the Company, its shareholders and their respective Affiliates and Representatives. Acquiror shall, and shall use its reasonable best efforts to cause its Affiliates and Representatives to, immediately cease any and all existing discussions or negotiations with any Person conducted prior to the date hereof with respect to, or which is reasonably likely to give rise to or result in, a Business Combination Proposal.

7.08 Stockholder Action. Acquiror shall notify the Company promptly in connection with a written threat to file, or filing by, an Action related to this Agreement or the Transaction by any of its stockholders or holders of any Acquiror Warrants against Acquiror or its Subsidiaries or against any of their respective directors or officers (any such action, a "Stockholder Action"). Acquiror shall keep the Company reasonably apprised of the defense, settlement, prosecution or other developments with respect to any such Stockholder Action. Acquiror shall give the Company the opportunity to participate in, subject to a customary joint defense agreement, but not control the defense of any such litigation, to give due consideration to the Company's advice with respect to such litigation and to not settle any such litigation without the prior written consent of the Company, such consent not to be unreasonably withheld, delayed or conditioned; provided that, for the avoidance of doubt, Acquiror shall bear all of its costs of investigation and all of its defense and attorneys' and other professionals' fees related to such Stockholder Action.

7.09 Written Consent of Merger Sub. Acquiror shall promptly after the execution of this Agreement, and in any event no later than the end of the day following the date of this Agreement, deliver its written consent, as the sole stockholder of Merger Sub, approving and adopting this Agreement and the Merger pursuant to Section 6.201 of the TBOC and in accordance with applicable law and the certificate of incorporation and bylaws of Merger Sub, and Acquiror shall promptly deliver to the Company evidence of such action taken by written consent.

7.10 Incentive Equity Plan. Prior to the Closing Date, Acquiror shall approve, and subject to approval of the stockholders of Acquiror, adopt, the Acquiror Incentive Plan.

7.11 Obligations as an Emerging Growth Company and a Controlled Company. Acquiror shall, at all times during the period from the date hereof until the Closing: (a) take all actions necessary to continue to qualify as an “emerging growth company” within the meaning of the Jumpstart Our Business Startups Act of 2012 (“JOBS Act”) and to qualify, at the Effective Time, as a “controlled” company under the rules of the Nasdaq; and (b) not take any action that would cause Acquiror to not qualify as an “emerging growth company” within the meaning of the JOBS Act or, at the Effective Time, as a “controlled” company under the rules of Nasdaq.

ARTICLE VIII JOINT COVENANTS

8.01 Subscription Agreements. Subject to the terms hereof, Company and Acquiror shall and shall cause their respective Affiliates to comply with its obligations, and enforce its rights, under the Subscription Agreements. Acquiror and Company shall give the other prompt notice of any breach by any party to the Subscription Agreements of which Acquiror or Company has become aware or any termination (or alleged or purported termination) of the Subscription Agreements. Acquiror shall keep the Company informed on a reasonably current basis in reasonable detail of the status of its efforts to obtain the proceeds of the Equity Financing and shall not permit any amendment or modification to, or any waiver of any material provision or remedy under, the Subscription Agreements entered into at or prior to the date hereof if such amendment, modification, waiver or remedy (i) would materially delay the occurrence of the Closing, (ii) reduces the aggregate amount of the Equity Financing, (iii) adds or imposes new conditions or amends the existing conditions to the consummation of the Equity Financing or (iv) is adverse to the interests of the Company, in each case, in any material respect. Notwithstanding the foregoing, to the extent the Minimum Cash Condition is satisfied, failure to obtain the proceeds from the Equity Financing shall not relieve Acquiror or Company their respective obligations to consummate the transactions contemplated by this Agreement, whether or not such Equity Financing is available.

8.02 Support of Transaction. Without limiting any covenant contained in Article VI or Article VII, including the obligations of the Company and Acquiror with respect to the notifications, filings, reaffirmations and applications described in Section 8.08, which obligations shall control to the extent of any conflict with the succeeding provisions of this Section 8.01, Acquiror and the Company shall each, and shall each cause their respective Subsidiaries to: (a) use commercially reasonable efforts to assemble, prepare and file any information (and, as needed, to supplement such information) as may be reasonably necessary to obtain as promptly as practicable all governmental and regulatory consents required to be obtained in connection with the Transactions, (b) use commercially reasonable efforts to obtain all material consents and approvals of third parties that any of Acquiror, the Company, or their respective Affiliates are required to obtain in order to consummate the Transactions, including any required approvals of parties to material Contracts with the Company, and (c) take such other action as may reasonably be necessary or as another party may reasonably request to satisfy the conditions of Article IX or otherwise to comply with this Agreement and to consummate the Transactions as soon as practicable. Notwithstanding the foregoing, in no event shall Acquiror, Merger Sub or the Company be obligated to bear any expense or pay any fee or grant any concession in connection with obtaining any consents, authorizations or approvals pursuant to the terms of any Contract to which the Company is a party or otherwise in connection with the consummation of the Transactions.

8.03 Preparation of Registration Statement; Special Meeting; Solicitation of Company Requisite Approval.

(a) Promptly following the date hereof, Acquiror shall cause to be filed with the SEC a registration statement on Form S-4 (as amended or supplemented from time to time, and including the Proxy Statement contained therein, the “Registration Statement”) in connection with the registration under the Securities Act of the PubCo’s Common Stock to be issued under this Agreement (including the Earnout Shares), which Registration Statement will also contain the Proxy Statement. Each of Acquiror and the Company shall use its reasonable best efforts to cause the Registration Statement and the Proxy Statement to comply with the rules and regulations promulgated by the SEC, to have the Registration Statement declared effective under the Securities Act as promptly as practicable after such filing and to keep the Registration Statement effective as long as is necessary to consummate the Merger. Acquiror acknowledges that the Company has furnished all information concerning the Company as may reasonably be requested by Acquiror in connection with such actions and the preparation of the Registration Statement and the Proxy Statement. Promptly after the Registration Statement is declared effective under the Securities Act, Acquiror will cause the Proxy Statement to be mailed to stockholders of Acquiror.

(b) Each of Acquiror and the Company shall cooperate and mutually agree upon (such agreement not to be unreasonably withheld or delayed), any response to comments of the SEC or its staff with respect to the Registration Statement and any amendment to the Registration Statement filed in response thereto. If Acquiror or

[Table of Contents](#)

the Company becomes aware that any information contained in the Registration Statement shall have become false or misleading in any material respect or that the Registration Statement is required to be amended in order to comply with applicable Law, then (i) such party shall promptly inform the other parties and (ii) Acquiror, on the one hand, and the Company, on the other hand, shall cooperate and mutually agree upon (such agreement not to be unreasonably withheld or delayed) an amendment or supplement to the Registration Statement. Acquiror and the Company shall use reasonable best efforts to cause the Registration Statement, as so amended or supplemented, to be filed with the SEC and the Proxy Statement to be disseminated to the holders of shares of Acquiror Common Stock, as applicable, in each case pursuant to applicable Law and subject to the terms and conditions of this Agreement and the Acquiror Organizational Documents. Acquiror shall provide the other parties with copies of any written comments, and shall inform such other parties of any oral comments, that Acquiror receives from the SEC or its staff with respect to the Registration Statement promptly after the receipt of such comments and shall give the other parties a reasonable opportunity to review and comment on any proposed written or oral responses to such comments prior to responding to the SEC or its staff.

(c) Acquiror agrees to include provisions in the Proxy Statement and to take reasonable action related thereto with respect to (i) approval of the Merger (the "Transaction Proposal"), (ii) approval of the PubCo Charter (the "Amendment Proposal"), (iii) approval of the issuance of PubCo's Common Stock in connection with the Transactions (including pursuant to the consummation of the Subscription Agreements) in accordance with this Agreement, in each case to the extent required by Nasdaq listing rules (the "Stock Issuance Proposal"), (iv) the adoption of the Acquiror Incentive Plan (the "Acquiror Incentive Plan Proposal") and (v) approval of any other proposals reasonably necessary or appropriate to consummate the transaction contemplated hereby (the "Additional Proposal") and together with the Agreement Proposal, Merger Proposal, Amendment Proposal, Acquiror Incentive Plan Proposal and the Stock Issuance Proposal, the "Proposals"). The Acquiror Incentive Plan Proposal shall provide that an aggregate number of shares of PubCo's Common Stock equal to 10% of the fully diluted outstanding shares of PubCo's Common Stock immediately after the Closing shall be reserved for issuance pursuant to the Acquiror Incentive Plan, subject to annual increases as provided therein. Without the prior written consent of the Company, the Proposals shall be the only matters (other than procedural matters) which Acquiror shall propose to be acted on by Acquiror's stockholders at the Special Meeting.

(d) Acquiror and the Company shall use reasonable best efforts to, as promptly as practicable, and in compliance with applicable Law (i) establish the record date for, duly call, give notice of, convene and hold the Special Meeting in accordance with the DGCL, (ii) cause the Proxy Statement to be disseminated to Acquiror's stockholders and (iii) solicit proxies from the holders of Acquiror Common Stock to vote in favor of each of the Proposals. Acquiror shall, through the Acquiror Board, recommend to its stockholders that they approve each of the Proposals (the "Acquiror Board Recommendation") and shall include the Acquiror Board Recommendation in the Proxy Statement. The Acquiror Board shall not (and no committee or subgroup thereof shall) change, withdraw, withhold, qualify or modify, or publicly propose to change, withdraw, withhold, qualify or modify, the Acquiror Board Recommendation. Notwithstanding the foregoing provisions of this Section 8.03(d), if on a date for which the Special Meeting is scheduled, Acquiror has not received proxies representing a sufficient number of shares of Acquiror Common Stock to obtain the Acquiror Stockholder Approval, whether or not a quorum is present, Acquiror shall have the right to make one or more successive postponements or adjournments of the Special Meeting.

(e) The Company shall solicit the Company Requisite Approval via written consent as soon as promptly as practicable after the Registration Statement becomes effective. In connection therewith, Acquiror and the Company shall use reasonable best efforts to, as promptly as practicable, (i) cause the Consent Solicitation Statement to be disseminated to the Company Stockholders in compliance with applicable Law and (iii) solicit written consents from the Company Stockholders to give the Company Requisite Approval. The Company shall, through the Company Board, recommend to the Company Stockholders that they adopt this Agreement (the "Company Board Recommendation") and shall include the Company Board Recommendation in the Consent Solicitation Statement. The Company Board shall not (and no committee or subgroup thereof shall) change, withdraw, withhold, qualify or modify, or publicly propose to change, withdraw, withhold, qualify or modify, the Company Board Recommendation. The Company will provide Acquiror with copies of all stockholder consents it receives within one (1) Business Day of receipt of the Company Requisite Approval. If the Company Requisite Approval is obtained, then promptly following the receipt of the required written consents, the Company will prepare and deliver to its stockholders who have not consented the notice required by Section 10.355 of the TBOC. Unless this Agreement has been terminated in accordance with its terms, the Company's obligation to solicit written consents from the Company Stockholders to give the Company Requisite Approval in accordance with this Section 8.03(e) shall not be limited or otherwise affected by the making, commencement, disclosure, announcement or submission of any Acquisition Proposal.

[Table of Contents](#)

8.04 Tax Matters.

(a) Transfer Taxes. Notwithstanding anything to the contrary contained herein, the PubCo shall pay all transfer, documentary, sales, use, stamp, registration, value added or other similar Taxes incurred in connection with the Transactions. Pubco shall, at its own expense, file all necessary Tax Returns with respect to all such Taxes, and, if required by applicable Law, the Company will join in the execution of any such Tax Returns.

(b) Tax Treatment. Acquiror, Merger Sub and the Company intend that the Transactions shall qualify for the Intended Tax Treatment. None of the parties or their respective Affiliates shall knowingly take or cause to be taken, or knowingly fail to take or knowingly cause to be failed to be taken, any action that would reasonably be expected to prevent qualification for such Intended Tax Treatment. Each party shall, unless otherwise required by a final determination within the meaning of Section 1313(a) of the Code (or any similar state, local or non-U.S. final determination) or a change in applicable Law, or based on a change in the facts and circumstances underlying the Transactions from the terms described in this Agreement, cause all Tax Returns to be filed on a basis of treating the Merger as a “reorganization” within the meaning of Section 368(a) of the Code. Each of the parties agrees to use reasonable best efforts to promptly notify all other parties of any challenge to the Intended Tax Treatment by any Governmental Authority.

(c) The Company, Acquiror and Merger Sub hereby adopt this Agreement as a “plan of reorganization” within the meaning of Treasury Regulation Sections 1.368-2(g) and 1.368-3(a).

(d) On or prior to the Closing Date, the Company shall deliver to Acquiror a certification from the Company pursuant to Treasury Regulations Section 1.1445-2(c) dated no more than thirty (30) days prior to the Closing Date and signed by a responsible corporate officer of the Company; provided that, notwithstanding anything to the contrary, Acquiror’s sole remedy in the event the Company fails to deliver such certificate shall be to make a proper withholding of Tax to the extent required by applicable Law.

8.05 Confidentiality; Publicity.

(a) Acquiror acknowledges that the information being provided to it in connection with this Agreement and the consummation of the transactions contemplated hereby is subject to the terms of the Confidentiality Agreement, the terms of which are incorporated herein by reference.

(b) None of Acquiror, the Company or any of their respective Affiliates shall make any public announcement or issue any public communication regarding this Agreement or the transactions contemplated hereby, or any matter related to the foregoing, without first obtaining the prior consent of the Company or Acquiror, as applicable (which consent shall not be unreasonably withheld, conditioned or delayed), except if such announcement or other communication is required by applicable Law or legal process (including pursuant to the Securities Law or the rules of any national securities exchange), in which case Acquiror or the Company, as applicable, shall use their commercially reasonable efforts to coordinate such announcement or communication with the other party, prior to announcement or issuance and allow the other party a reasonable opportunity to comment thereon (which shall be considered by Acquiror or the Company, as applicable, in good faith); provided, however, that, notwithstanding anything contained in this Agreement to the contrary, each party and its Affiliates may make announcements and may provide information regarding this Agreement and the transactions contemplated hereby to its and their Affiliates, and its and their respective investors, directors, officers, employees, managers and advisors without the consent of any other party hereto; and provided further that, subject to Section 6.02 and this Section 8.05, the foregoing shall not prohibit any party hereto from communicating with third parties to the extent necessary for the purpose of seeking any third party consent.

8.06 Post-Closing Cooperation; Further Assurances. Following the Closing, each party shall, on the request of any other party, execute such further documents, and perform such further acts, as may be reasonably necessary or appropriate to give full effect to the allocation of rights, benefits, obligations and liabilities contemplated by this Agreement and the transactions contemplated hereby.

8.07 Additional Insurance and Indemnity Matters.

(a) Prior to the Closing, Acquiror and the Company shall reasonably cooperate in order to obtain directors’ and officers’ liability insurance for PubCo and the Company that shall be effective as of Closing and will cover (i) those Persons who were directors and officers of the Company prior to the Closing and (ii) those Persons who

[Table of Contents](#)

will be the directors and officers of PubCo and its Subsidiaries (including the directors and officers of the Company) at and after the Closing on terms not less favorable than the better of (a) the terms of the current directors' and officers' liability insurance in place for the Company's directors and officers and (b) the terms of a typical directors' and officers' liability insurance policy for a company whose equity is listed on Nasdaq which policy has a scope and amount of coverage that is reasonably appropriate for a company of similar characteristics (including the line of business and revenues) as PubCo and its Subsidiaries (including the Surviving Company).

(b) Prior to the Effective Time, Acquiror shall obtain, as of the Closing Date a "tail" insurance policy, to the extent available on commercially reasonable terms and at an aggregate cost of no higher than 300% of the premium of Acquiror's directors' and officers' liabilities insurance policy as of the date of this Agreement, extending coverage for an aggregate period of six (6) years (or such other coverage period as mutually agreed by Acquiror and the Company) providing directors' and officers' liability insurance with respect to claims arising from facts or events that occurred on or before the Closing covering (as direct beneficiaries) those persons who are as of the date of this Agreement currently covered by the Acquiror's directors' and officers' liability insurance policy, of the type and with the amount of coverage no less favorable than those of the directors' and officers' liability insurance maintained as of the date of this Agreement by, or for the benefit of, the Acquiror; provided, however, that to the extent a policy as permitted by this [Section 8.07\(b\)](#) is purchased by Purchaser, the aggregate cost of such policy shall be deemed an Outstanding Acquiror Expense.

(c) Prior to the Effective Time, PubCo and the Surviving Company shall indemnify and hold harmless each present and former director or officer of the Company, or any other person that may be a director or officer of the Company prior to the Effective Time, against any costs or expenses (including reasonable attorneys' fees), judgments, fines, losses, claims, damages or liabilities incurred in connection with any actual or threatened Action or other action, suit, proceeding or investigation, whether civil, criminal, administrative or investigative, arising out of or pertaining to matters existing or occurring at or prior to the Effective Time or relating to the enforcement by any such Person of his or her rights under this [Section 8.07](#), whether asserted or claimed prior to, at or after the Effective Time, to the fullest extent that the Company, would have been permitted under applicable Law and its certificate of incorporation, bylaws or other organizational documents in effect on the date of this Agreement to indemnify such Person, and shall advance expenses (including reasonable attorneys' fees and expenses) of any such Person as incurred to the fullest extent permitted under applicable Law (including, without limitation, in connection with any action, suit or proceeding brought by any such Person to enforce his or her rights under this [Section 8.07](#)). Without limiting the foregoing, PubCo shall, and shall cause the Surviving Company and its Subsidiaries to, (i) maintain for a period of not less than six years from the Effective Time provisions in its certificate of incorporation (if applicable), bylaws and other organizational documents concerning the indemnification and exoneration (including provisions relating to expense advancement) of officers and directors that are no less favorable to those Persons than the provisions of such certificates of incorporation (if applicable), bylaws and other organizational documents as of the date of this Agreement and (ii) not amend, repeal or otherwise modify such provisions in any respect that would adversely affect the rights of those Persons thereunder, in each case, except as required by Law. PubCo shall assume, and be liable for, and shall cause the Surviving Company and their respective Subsidiaries to honor, each of the covenants in this [Section 8.07](#).

(d) Notwithstanding anything contained in this Agreement to the contrary, this [Section 8.07](#) shall survive the consummation of the Merger indefinitely and shall be binding, jointly and severally, on PubCo and the Surviving Company and all successors and assigns of PubCo and the Surviving Company. In the event that PubCo, the Surviving Company or any of their respective successors or assigns consolidates with or merges into any other Person and shall not be the continuing or surviving corporation or entity of such consolidation or merger or transfers or conveys all or substantially all of its properties and assets to any Person or effects any division transaction, then, and in each such case, PubCo and the Surviving Company shall ensure that proper provision shall be made so that the successors and assigns of PubCo or the Surviving Company, as the case may be, shall succeed to the obligations set forth in this [Section 8.07](#). The obligations of PubCo and the Surviving Company under this [Section 8.07](#) shall not be terminated or modified in such a manner as to materially and adversely affect any present and former director or officer of the Company, or other person that may be a director or officer of the Company prior to the Effective Time, to whom this [Section 8.07](#) applies without the consent of the affected Person. The rights of each person entitled to indemnification or advancement hereunder shall be in addition to, and not in limitation of, any other rights such Person may have under the Company Certificate of Incorporation, the bylaws of the Company, any other indemnification arrangement, any applicable law, rule or regulation or otherwise. The provisions of this [Section 8.07](#) are expressly intended to benefit, and are enforceable by, each Person entitled to indemnification or advancement hereunder and their respective successors, heirs and representatives, each of whom is an intended third-party beneficiary of this [Section 8.07](#).

8.08 HSR Act and Regulatory Approvals.

(a) In connection with the transactions contemplated by this Agreement, each of Acquiror and the Company shall comply promptly but in no event later than ten (10) Business Days after the date hereof with the notification and reporting requirements of the HSR Act, if applicable. Each of Acquiror and the Company shall furnish to the other as promptly as reasonably practicable all information required for any application or other filing to be made by such other party pursuant to any Antitrust Law, if applicable. Each of Acquiror and the Company shall substantially comply with any Information or Document Requests.

(b) Each of Acquiror and the Company shall request early termination of any waiting period under the HSR Act, if applicable, and exercise its reasonable best efforts to (i) obtain termination or expiration of the waiting period under the HSR Act, if applicable, and consents or approvals pursuant to any other applicable Antitrust Laws, (ii) prevent the entry in any Action brought by a Regulatory Consent Authority or any other Person of any Governmental Order which would prohibit, make unlawful or delay the consummation of the transactions contemplated by this Agreement and (iii) if any such Governmental Order is issued in any such Action, cause such Governmental Order to be lifted.

(c) Each of Acquiror and the Company shall cooperate in good faith with the Regulatory Consent Authorities and exercise its reasonable best efforts to undertake promptly any and all action required to complete lawfully the transactions contemplated by this Agreement as soon as practicable (but in any event prior to the Termination Date) and any and all action necessary or advisable to avoid, prevent, eliminate or remove any impediment under Antitrust Law or the actual or threatened commencement of any proceeding in any forum by or on behalf of any Regulatory Consent Authority or the issuance of any Governmental Order that would delay, enjoin, prevent, restrain or otherwise prohibit the consummation of the Merger. Without limiting the generality of the foregoing, each of Acquiror and the Company shall, and shall cause its respective Subsidiaries (as applicable) to, (i) propose, negotiate, commit to and effect, by consent decree, hold separate orders or otherwise, the sale, divestiture, disposition, or license of any investments, assets, properties, products, rights, services or businesses of such party or any interest therein, and (ii) otherwise take or commit to take any actions that would limit such party's freedom of action with respect to, or its or their ability to retain any assets, properties, products, rights, services or businesses of such party, or any interest or interests therein; provided, that any such action contemplated by this Section 8.08(c) is conditioned upon the consummation of the Merger. Notwithstanding anything in this Agreement to the contrary, nothing in this Section 8.08 or any other provision of this Agreement shall require or obligate the Company's Affiliates and investors, the Acquiror's Affiliates and investors, including the Sponsor, their respective Affiliates and any investment funds or investment vehicles affiliated with, or managed or advised by, Acquiror's Affiliates and investors, including the Sponsor, or any portfolio company (as such term is commonly understood in the private equity industry) or investment of Acquiror's Affiliates and investors including, the Sponsor, or of any such investment fund or investment vehicle to take any action in connection with avoiding, preventing, eliminating or removing any impediment under Antitrust Law with respect to the Transactions, including selling, divesting, or otherwise disposing of, licensing, holding separate, or taking or committing to take any action that limits in any respect such Person's or entity's freedom of action with respect to, or its ability to retain, any business, products, rights, services, licenses, assets or properties of such Person or entity or any of such entity's Subsidiaries or Affiliates, or any interest therein.

(d) Each of the Acquiror and the Company shall promptly notify the other of any substantive communication with, and furnish to such other party copies of any notices or written communications received by, Acquiror or the Company, as applicable, or any of its respective Affiliates and any third party or Governmental Authority with respect to the transactions contemplated by this Agreement, and each of the Acquiror and the Company shall permit counsel to such other party an opportunity to review in advance, and each of Acquiror and the Company shall consider in good faith the views of such other party's counsel in connection with, any proposed communications by Acquiror or the Company, as applicable, and/or its respective Affiliates to any Governmental Authority concerning the transactions contemplated by this Agreement; provided that neither Acquiror nor the Company shall extend any waiting period or comparable period under the HSR Act, if applicable, or enter into any agreement with any Governmental Authority without the written consent of such other party. Each of the Acquiror and the Company agrees to provide, to the extent permitted by the applicable Governmental Authority, such other party and its counsel the opportunity, on reasonable advance notice, to participate in any substantive meetings or discussions, either in person or by telephone, between such party and/or any of its Affiliates, agents or advisors, on the one hand, and any

[Table of Contents](#)

Governmental Authority, on the other hand, concerning or in connection with the transactions contemplated hereby. Any materials exchanged in connection with this [Section 8.07](#) may be redacted or withheld as necessary to address reasonable privilege or confidentiality concerns, and to remove references concerning the valuation of the Company or the Acquiror, as applicable, or other competitively sensitive material; provided, that each of Acquiror and the Company may, as it deems advisable and necessary, designate any materials provided to such other party under this [Section 8.07](#) as “outside counsel only.” Notwithstanding anything in this Agreement to the contrary, nothing in this [Section 8.07](#) or any other provision of this Agreement shall require or obligate the Company or any of its investors or Affiliates to, and Acquiror shall not, without the prior written consent of the Company, agree or otherwise be required to, take any action with respect to the Company, or such investors or Affiliates, including selling, divesting, or otherwise disposing of, licensing, holding separate, or taking or committing to take any action that limits in any respect its freedom of action with respect to, or its ability to retain, any business, products, rights, services, licenses, assets or properties of the Company or such investors or Affiliates, or any interest therein.

(e) Acquiror and Company shall each be responsible for one-half of all filing fees, if any, payable to the Regulatory Consent Authorities in connection with the transactions contemplated by this Agreement.

(f) Each of Acquiror and the Company shall not, and shall cause its respective Subsidiaries (as applicable) not to, acquire or agree to acquire, by merging with or into or consolidating with, or by purchasing a portion of the assets of or equity in, or by any other manner, any business or any corporation, partnership, association or other business organization or division thereof, or otherwise acquire or agree to acquire any assets, or take any other action, if the entering into of a definitive agreement relating to, or the consummation of such acquisition, merger or consolidation, or the taking of any other action, would reasonably be expected to: (i) impose any delay in the obtaining of, or increase the risk of not obtaining, any authorizations, consents, orders or declarations of any Regulatory Consent Authorities or the expiration or termination of any applicable waiting period; (ii) increase the risk of any Governmental Authority entering an order prohibiting the consummation of the transaction contemplated hereby; (iii) increase the risk of not being able to remove any such order on appeal or otherwise; or (iv) delay or prevent the consummation of the transactions contemplated hereby. Notwithstanding anything in this Agreement to the contrary, the restrictions and obligations set forth in this [Section 8.08\(f\)](#) shall not apply to or be binding upon Acquiror’s Affiliates, the Sponsor, their respective Affiliates or any investment funds or investment vehicles affiliated with, or managed or advised by, Acquiror’s Affiliates, the Sponsor, or any portfolio company (as such term is commonly understood in the private equity industry) or investment of Acquiror’s Affiliates, the Sponsor, or any such investment fund or investment vehicle.

8.09 Employee Matters. The Company and the Acquiror shall cooperate in good faith to identify certain employees of the Company who shall enter into new employment agreements in a form to be reasonably agreed upon between the Company and the Acquiror to be effective on the Closing Date.

8.10 Non-Solicitation; Acquisition Proposals.

(a) Except as expressly permitted by this [Section 8.10](#), from the date of this Agreement until the Effective Time or, if earlier, the valid termination of this Agreement in accordance with [Section 11.01](#), each Party shall not, and shall use its reasonable best efforts to cause its Representatives not to, directly or indirectly, (i) initiate, solicit or knowingly encourage or knowingly facilitate any inquiries or requests for information with respect to, or the making of, any inquiry regarding, or any proposal or offer that constitutes, or could reasonably be expected to result in or lead to, any Acquisition Proposal, (ii) engage in, continue or otherwise participate in any negotiations or discussions concerning, or provide access to its properties, books and records or any confidential information or data to, any Person (other than a Party to this Agreement) relating to any proposal, offer, inquiry or request for information that constitutes, or could reasonably be expected to result in or lead to, any Acquisition Proposal, (iii) approve, endorse or recommend, or propose publicly to approve, endorse or recommend, any Acquisition Proposal, (iv) execute or enter into, any letter of intent, memorandum of understanding, agreement in principle, confidentiality agreement, merger agreement, acquisition agreement, exchange agreement, joint venture agreement, partnership agreement, option agreement or other similar agreement for or relating to any Acquisition Proposal or (v) resolve or agree to do any of the foregoing. Each Party also agrees that immediately following the execution of this Agreement it shall and shall use commercially reasonable efforts to cause its Representatives to, cease any solicitations, discussions or negotiations with any Person (other than the Parties and their respective Representatives) conducted heretofore in connection with an Acquisition Proposal or any inquiry or request for information that could reasonably be expected to lead to, or result in, an Acquisition Proposal.

(b) The Company also agrees that within three (3) Business Days of the execution of this Agreement, the Company shall request each Person (other than the parties and their respective Representatives) that has prior to the date hereof executed a confidentiality agreement in connection with its consideration of acquiring the Company (and with whom the Company has had contact in the three (3) months prior to the date of this Agreement regarding the acquisition of the Company) to return or destroy all confidential information furnished to such Person by or on behalf of it or any of its subsidiaries prior to the date hereof and terminate access to any physical or electronic data room maintained by or on behalf of the Company. The Company shall promptly (and in any event within one Business Day) notify, in writing, Acquiror of the receipt of any inquiry, proposal, offer or request for information received after the date hereof that constitutes, or could reasonably be expected to result in or lead to, any Acquisition Proposal. The Company shall promptly (and in any event within two Business Days) keep Acquiror reasonably informed of any material developments with respect to any such inquiry, proposal, offer, request for information or Acquisition Proposal (including any material changes thereto). Without limiting the foregoing, it is understood that any violation of the restrictions contained in this [Section 6.06](#) by any Party's Representatives acting on such Party's behalf shall be deemed to be a breach of this [Section 6.06](#) by such Party.

(c) For purposes of this [Section 6.06](#), "[Acquisition Proposal](#)" means any proposal or offer from any Person or "group" (as defined in the Exchange Act) (other than Acquiror, Merger Sub or their respective Affiliates) relating to and Alternative Transaction. An "[Alternative Transaction](#)" means (A) with respect to the Company, in a single transaction or series of related transactions, (i) any direct or indirect acquisition or purchase of a business that constitutes 20% or more of the net revenues, net income or assets of the Company, (ii) any direct or indirect acquisition of 20% or more of the consolidated assets of the Company (based on the fair market value thereof, as determined in good faith by the Company Board), including through the acquisition of one or more subsidiaries of the Company owning such assets, (iii) acquisition of beneficial ownership, or the right to acquire beneficial ownership, of 20% or more of the total voting power of the equity securities of the Company, any tender offer or exchange offer that if consummated would result in any Person beneficially owning 20% or more of the total voting power of the equity securities of the Company, or any merger, reorganization, consolidation, share exchange, business combination, recapitalization, liquidation, dissolution or similar transaction involving the Company (or any subsidiary of the Company whose business constitutes 20% or more of the net revenues, net income or assets of the Company and its subsidiaries, taken as a whole) or (iv) any issuance or sale or other disposition (including by way of merger, reorganization, division, consolidation, share exchange, business combination, recapitalization or other similar transaction) of 20% or more of the total voting power of the equity securities of the Company; and (B) with respect to the Acquiror and Merger Sub, a transaction (other than the transactions contemplated by this Agreement) concerning an initial business combination for Acquiror.

ARTICLE IX CONDITIONS TO OBLIGATIONS

9.01 [Conditions to Obligations of All Parties](#). The obligations of the parties hereto to consummate, or cause to be consummated, the Merger are subject to the satisfaction of the following conditions, any one or more of which may be waived (if legally permitted) in a joint writing duly executed by all of such parties:

(a) [HSR Act](#). The applicable waiting period(s) under the HSR Act in respect of the Transactions shall have expired or been terminated.

(b) [No Prohibition](#). There shall not have been enacted or promulgated any Governmental Order, statute, rule or regulation enjoining or prohibiting the consummation of the Transactions.

(c) [Offer Completion](#). The Offer shall have been completed in accordance with the terms hereof, the Acquiror Organizational Documents and the Proxy Statement.

(d) [Net Tangible Assets](#). The Acquiror shall not have redeemed shares of Acquiror Common Stock in the Offer in an amount that would cause Acquiror to have less than \$5,000,001 of net tangible assets (as determined in accordance with Rule 3a51-1(g)(1) of the Exchange Act).

(e) [Acquiror Stockholder Approval](#). The Acquiror Stockholder Approval shall have been obtained.

(f) [Company Requisite Approval](#). The Company Requisite Approval shall have been obtained.

(g) [Listing](#). PubCo's Common Stock to be issued in connection with the Transactions (including the Earnout Shares) shall have been approved for listing on Nasdaq subject only to official notice of issuance thereof.

9.02 Additional Conditions to Obligations of Acquiror. The obligations of Acquiror to consummate, or cause to be consummated, the Merger are subject to the satisfaction of the following additional conditions, any one or more of which may be waived in writing by Acquiror:

(a) Representations and Warranties.

(i) Each of the representations and warranties of the Company contained in the first sentence of Section 4.01(a) (*Due Incorporation*), Section 4.03 (*Due Authorization*), Section 4.06 (*Capitalization*) and Section 4.16 (*Broker's Fees*) and shall be true and correct (without giving any effect to any limitation as to "materiality" or "Material Adverse Effect" or any similar limitation set forth therein) in all material respects as of the date hereof and as of the Closing Date as though then made (except to the extent such representations and warranties expressly relate to an earlier date, and in such case, shall be true and correct on and as of such earlier date).

(ii) Each of the representations and warranties of the Company contained in this Agreement (other than the representations and warranties of the Company described in Section 9.02(a)(i) and (ii)) shall be true and correct (without giving any effect to any limitation as to "materiality" or "Material Adverse Effect" or any similar limitation set forth therein) as of the date hereof and as of the Closing Date as though then made (except to the extent such representations and warranties expressly relate to an earlier date, and in such case, shall be true and correct on and as of such earlier date), except, in either case, where the failure of such representations and warranties to be so true and correct, individually or in the aggregate, has not had, and would not reasonably be expected to result in, a Material Adverse Effect.

(b) Agreements and Covenants. Each of the covenants of the Company to be performed or complied with as of or prior to the Closing shall have been performed or complied with in all material respects.

(c) Officer's Certificate. The Company shall have delivered to Acquiror a certificate signed by an officer of the Company, dated the Closing Date, certifying that, to the knowledge and belief of such officer, the conditions specified in Section 9.02(a) and Section 9.02(b) have been fulfilled.

(d) Earnout Escrow Agreement. The Stockholder Representative shall deliver to the Company a duly executed counterpart of the Earnout Escrow Agreement.

(e) Director Nomination Agreement. The Company shall deliver to Acquiror a counterpart of the Director Nomination Agreement, the form of which is attached hereto as Exhibit G (the "Director Nomination Agreement") duly executed by Company, which shall be effective immediately following the Effective Time.

(f) Lock-Up Agreements. The persons listed on Schedule 9.02(f) shall have entered into a Lock-up Agreement.

9.03 Additional Conditions to the Obligations of the Company. The obligation of the Company to consummate the Merger is subject to the satisfaction of the following additional conditions, any one or more of which may be waived in writing by the Company:

(a) Representations and Warranties.

(i) Each of the representations and warranties of Acquiror and Merger Sub contained in this Agreement (other than the representations and warranties of Acquiror and Merger Sub contained in Section 5.15 (*Capitalization*)) (without giving effect to any limitation as to "materiality", "material adverse effect" or any similar limitation set forth therein) shall be true and correct in all material respects as of the date hereof and as of the Closing Date, as if made anew at and as of that time, except with respect to representations and warranties which speak as to an earlier date, which representations and warranties shall be true and correct in all material respects at and as of such date.

(ii) The representations and warranties of Acquiror and Merger Sub contained in Section 5.15 (*Capitalization*) shall be true and correct in all respects, as of the date hereof and as of the Closing Date (immediately prior to the effectiveness of the PubCo Charter), as if made anew at and as of that time.

[Table of Contents](#)

(b) Agreements and Covenants. Each of the covenants of Acquiror to be performed or complied with as of or prior to the Closing shall have been performed or complied with in all material respects.

(c) Officer's Certificate. Acquiror and Merger Sub shall have delivered to the Company a certificate signed by an officer of Acquiror, dated the Closing Date, certifying that, to the knowledge and belief of such officer, the conditions specified in Section 9.03(a) and Section 9.03(b) have been fulfilled.

(d) PubCo Charter. The Certificate of Incorporation shall be amended and restated in the form of the PubCo Charter.

(e) Earnout Escrow Agreement. Acquiror shall deliver to the Company a duly executed counterpart of the Earnout Escrow Agreement, including the deposit of the Earnout Shares.

(f) Director Nomination Agreement. Acquiror shall deliver to the Company a counterpart of the Director Nomination Agreement, duly executed by the Sponsor to be effective immediately following the Effective Time.

(g) Minimum Cash Condition. The aggregate cash available to Acquiror at the Closing from the Trust Account and the Equity Financing (after giving effect to the redemption of any shares of Acquiror Common Stock in connection with the Offer and the payment of the Outstanding Acquiror Expenses and the Outstanding Company Expenses) shall equal or exceed \$50,000,000 (the "Minimum Cash Condition").

**ARTICLE X
TERMINATION/EFFECTIVENESS**

10.01 Termination. This Agreement may be terminated and the transactions contemplated hereby abandoned:

(a) by written consent of the Company and Acquiror;

(b) prior to the Closing, by written notice to the Company from Acquiror if (i) there is any breach of any representation, warranty, covenant or agreement on the part of the Company set forth in this Agreement (or any breach on the part of the applicable Company Stockholder that is a party to a Company Support Agreement of Section 1 of such Company Support Agreement), such that the conditions specified in Section 9.02(a) or Section 9.02(b) would not be satisfied at the Closing (a "Terminating Company Breach"), except that, if such Terminating Company Breach is curable by the Company through the exercise of its commercially reasonable efforts, then, for a period of up to 30 days (or any shorter period of the time that remains between the date Acquiror provides written notice of such violation or breach and the Termination Date) after receipt by the Company of notice from Acquiror of such breach (the "Company Cure Period"), such termination shall not be effective, and such termination shall become effective only if the Terminating Company Breach is not cured within the Company Cure Period, (ii) the Closing has not occurred on or before June 30, 2022 (such applicable date, the "Termination Date"), or (iii) the consummation of the Merger is permanently enjoined or prohibited by the terms of a final, non-appealable Governmental Order or a statute, rule or regulation; provided that the right to terminate this Agreement under Section 10.01(b)(ii) shall not be available if the failure of Acquiror or Merger Sub to fulfill any obligation under this Agreement has been the primary cause of, or primarily resulted in, the failure of the Closing to occur on or before such date;

(c) prior to the Closing, by written notice to Acquiror from the Company if (i) there is any breach of any representation, warranty, covenant or agreement on the part of Acquiror or Merger Sub set forth in this Agreement (or any breach on the part of the applicable holder of shares of Acquiror Common Stock that is a party to the Sponsor Support Agreement of Section 1 of such Sponsor Support Agreement), such that the conditions specified in Section 9.03(a) or Section 9.03(b) would not be satisfied at the Closing (a "Terminating Acquiror Breach"), except that, if any such Terminating Acquiror Breach is curable by Acquiror or Merger Sub, as applicable, through the exercise of its commercially reasonable efforts, then, for a period of up to 30 days (or any shorter period of the time that remains between the date the Company provides written notice of such violation or breach and the Termination Date) after receipt by Acquiror of notice from the Company of such breach (the "Acquiror Cure Period"), such termination shall not be effective, and such termination shall become effective only if the Terminating Acquiror Breach is not cured within the Acquiror Cure Period, (ii) the Closing has not occurred on or before the Termination Date, (iii) the consummation of the Merger is permanently enjoined or prohibited by the terms of a final, non-appealable Governmental Order or a

[Table of Contents](#)

statute, rule or regulation; provided, that the right to terminate this Agreement under Section 10.01(c)(ii) shall not be available if the Company's material failure to fulfill any obligation under this Agreement has been the primary cause of, or primarily resulted in, the failure of the Closing to occur on or before such date; or

(d) by written notice from either the Company or Acquiror to the other if the Acquiror Stockholder Approval is not obtained at the Special Meeting (subject to any adjournment or recess of the meeting).

10.02 Effect of Termination. Except as otherwise set forth in this Section 10.02, in the event of the termination of this Agreement pursuant to Section 10.01, this Agreement shall forthwith become void and have no effect, without any liability on the part of any party hereto or its respective Affiliates, officers, directors, employees or stockholders, other than liability of any party hereto for any Willful Breach of this Agreement by such party occurring prior to such termination subject to Section 6.05. The provisions of Sections 6.05, 8.05, 10.02 and Article XI (collectively, the "Surviving Provisions") and the Confidentiality Agreement, and any other Section or Article of this Agreement referenced in the Surviving Provisions, which are required to survive in order to give appropriate effect to the Surviving Provisions, shall in each case survive any termination of this Agreement. Notwithstanding the foregoing, a failure by Acquiror and Merger Sub to close in accordance with this Agreement when they are obligated to do so shall be deemed to be a Willful Breach of this Agreement.

**ARTICLE XI
MISCELLANEOUS**

11.01 Waiver. Any party to this Agreement may, to the fullest extent permitted by applicable law at any time prior to the Closing and before or after stockholder adoption of this Agreement, by action taken by its board of directors, or officers thereunto duly authorized, waive any of the terms or conditions of this Agreement, or by action taken by its board of directors and without further action on the part of its stockholders to the extent permitted by applicable law, agree to an amendment or modification to this Agreement in the manner contemplated by Section 11.10 and by an agreement in writing executed in the same manner (but not necessarily by the same Persons) as this Agreement.

11.02 Notices. All notices and other communications among the parties shall be in writing and shall be deemed to have been duly given (i) when delivered in person, (ii) when delivered after posting in the United States mail having been sent registered or certified mail return receipt requested, postage prepaid, (iii) when delivered by FedEx (or other nationally recognized overnight delivery service) or (iv) when e-mailed during normal business hours (and otherwise as of the immediately following Business Day), addressed as follows:

(a) If to Acquiror or Merger Sub, to:

CleanTech Acquisition Corp.
207 W. 25th Street, 9th Floor
New York, NY 10001
Attention: Eli Spiro
E-mail: espiro@axxcesscapital.com

with a copy to (which shall not constitute notice):

Loeb & Loeb LLP
345 Park Avenue
New York, NY 10154
Attn: Giovanni Caruso
Email: gcaruso@loeb.com

(b) If to the Company to:

Nauticus Robotics, Inc.
17146 Feathercraft Lane, Suite 450
Webster, TX 77598
Attention: Nicolaus Radford, CEO & CTO
Email: nradford@nauticusrobotics.com

with a copy to (which shall not constitute notice):

Winston & Strawn LLP
800 Capitol Street, Suite 2400
Houston, TX 77002
Attn: Michael Blankenship
Facsimile No.: (713) 651-2678
Email: mblankenship@winston.com

or to such other address or addresses as the parties may from time to time designate in writing.

11.03 Assignment. No party hereto shall assign this Agreement or any part hereof without the prior written consent of the other parties. Subject to the foregoing, this Agreement shall be binding upon and inure to the benefit of the parties hereto and their respective permitted successors and assigns. Any attempted assignment in violation of the terms of this Section 11.03 shall be null and void, *ab initio*.

11.04 Rights of Third Parties. Nothing expressed or implied in this Agreement is intended or shall be construed to confer upon or give any Person, other than the parties hereto, any right or remedies under or by reason of this Agreement; provided, however, that, notwithstanding the foregoing (a) in the event the Closing occurs, the present and former officers and directors of the Company and Acquiror (and their successors, heirs and representatives) are intended third-party beneficiaries of, and may enforce, Section 8.07 and (b) the past, present and future directors, officers, employees, incorporators, members, partners, stockholders, Affiliates, agents, attorneys, advisors and representatives of the parties, and any Affiliate of any of the foregoing (and their successors, heirs and representatives), are intended third-party beneficiaries of, and may enforce, Sections 11.14 and 11.16.

11.05 Expenses. Except as otherwise provided herein (including Section 3.09, Section 8.08(c)) and Section 8.04(a)), each party hereto shall bear its own expenses incurred in connection with this Agreement and the transactions herein contemplated whether or not such transactions shall be consummated, including all fees of its legal counsel, financial advisers and accountants.

11.06 Governing Law. This Agreement, the Transactions and all claims or causes of action based upon, arising out of, or related to this Agreement or the transactions contemplated hereby, shall be governed by, and construed in accordance with, the Laws of the State of Delaware, without giving effect to principles or rules of conflict of laws to the extent such principles or rules would require or permit the application of Laws of another jurisdiction.

11.07 Captions; Counterparts. The captions in this Agreement are for convenience only and shall not be considered a part of or affect the construction or interpretation of any provision of this Agreement. This Agreement may be executed in two or more counterparts, each of which shall be deemed an original, but all of which together shall constitute one and the same instrument.

11.08 Schedules and Exhibits. The Schedules and Exhibits referenced herein are a part of this Agreement as if fully set forth herein. All references herein to Schedules and Exhibits shall be deemed references to such parts of this Agreement, unless the context shall otherwise require. Any disclosure made by a party in the Schedules with reference to any section or schedule of this Agreement shall be deemed to be a disclosure with respect to all other sections or schedules to which such disclosure may apply solely to the extent the relevance of such disclosure is reasonably apparent on the face of the disclosure in such Schedule. Certain information set forth in the Schedules is included solely for informational purposes.

11.09 Entire Agreement. This Agreement (together with the Schedules and Exhibits to this Agreement) and that certain Confidentiality Agreement, dated August 11, 2021, between Acquiror and the Company (the "Confidentiality Agreement"), constitute the entire agreement among the parties relating to the transactions contemplated hereby and supersede any other agreements, whether written or oral, that may have been made or entered into by or among any of the parties hereto or any of their respective Subsidiaries relating to the transactions contemplated hereby. No representations, warranties, covenants, understandings, agreements, oral or otherwise, relating to the transactions contemplated by this Agreement exist between the parties except as expressly set forth or referenced in this Agreement and the Confidentiality Agreement.

11.10 Amendments. This Agreement may be amended or modified in whole or in part, only by a duly authorized agreement in writing executed in the same manner as this Agreement and which makes reference to this Agreement. The approval of this Agreement by the stockholders of any of the parties shall not restrict the ability of the board of directors of any of the parties to terminate this Agreement in accordance with Section 10.01 or to cause such party to enter into an amendment to this Agreement pursuant to this Section 11.10.

11.11 Severability. If any provision of this Agreement is held invalid or unenforceable by any court of competent jurisdiction, the other provisions of this Agreement shall remain in full force and effect. The parties further agree that if any provision contained herein is, to any extent, held invalid or unenforceable in any respect under the Laws governing this Agreement, they shall take any actions necessary to render the remaining provisions of this Agreement valid and enforceable to the fullest extent permitted by Law and, to the extent necessary, shall amend or otherwise modify this Agreement to replace any provision contained herein that is held invalid or unenforceable with a valid and enforceable provision giving effect to the intent of the parties.

11.12 Jurisdiction: WAIVER OF TRIAL BY JURY. Any Action based upon, arising out of or related to this Agreement, or the transactions contemplated hereby, shall be brought in the Court of Chancery of the State of Delaware or, if such court declines to exercise jurisdiction, any federal or state court located in the State of Delaware, and each of the parties irrevocably submits to the exclusive jurisdiction of each such court in any such Action, waives any objection it may now or hereafter have to personal jurisdiction, venue or to convenience of forum, agrees that all claims in respect of the Action shall be heard and determined only in any such court, and agrees not to bring any Action arising out of or relating to this Agreement or the transactions contemplated hereby in any other court. Nothing herein contained shall be deemed to affect the right of any party to serve process in any manner permitted by Law, or to commence legal proceedings or otherwise proceed against any other party in any other jurisdiction, in each case, to enforce judgments obtained in any Action brought pursuant to this Section 11.12. EACH OF THE PARTIES HERETO HEREBY IRREVOCABLY WAIVES ANY AND ALL RIGHT TO TRIAL BY JURY IN ANY ACTION BASED UPON, ARISING OUT OF OR RELATED TO THIS AGREEMENT OR THE TRANSACTIONS CONTEMPLATED HEREBY.

11.13 Enforcement. The parties agree that irreparable damage for which monetary damages, even if available, would not be an adequate remedy, would occur in the event that the parties do not perform their obligations under the provisions of this Agreement (including failing to take such actions as are required of them hereunder to consummate this Agreement) in accordance with its specified terms or otherwise breach such provisions. The parties acknowledge and agree that (a) the parties shall be entitled to an injunction, specific performance, or other equitable relief, to prevent breaches of this Agreement and to enforce specifically the terms and provisions hereof, without proof of damages, prior to the valid termination of this Agreement in accordance with Section 10.01, this being in addition to any other remedy to which they are entitled under this Agreement, and (b) the right of specific enforcement is an integral part of the transactions contemplated by this Agreement and without that right, none of the parties would have entered into this Agreement. Each party agrees that it will not oppose the granting of specific performance and other equitable relief on the basis that the other parties have an adequate remedy at Law or that an award of specific performance is not an appropriate remedy for any reason at Law or equity. The parties acknowledge and agree that any party seeking an injunction to prevent breaches of this Agreement and to enforce specifically the terms and provisions of this Agreement in accordance with this Section 11.13(a) shall not be required to provide any bond or other security in connection with any such injunction.

11.14 Non-Recourse. This Agreement may only be enforced against, and any claim or cause of action based upon, arising out of, or related to this Agreement or the transactions contemplated hereby may only be brought against, the Named Parties, and then only with respect to the specific obligations set forth herein or in an Ancillary Agreement with respect to such Named Party. Except to the extent a Named Party to this Agreement or an Ancillary Agreement and then only to the extent of the specific obligations undertaken by such Named Party in this Agreement or in the applicable Ancillary Agreement, (a) no past, present or future director, officer, employee, incorporator, member, partner, stockholder, Affiliate, agent, attorney, advisor or representative or Affiliate of any named party to this Agreement or any Ancillary Agreement, and (b) no past, present or future director, officer, employee, incorporator, member, partner, stockholder, Affiliate, agent, attorney, advisor or representative or Affiliate of any of the foregoing shall have any liability (whether in contract, tort, equity or otherwise) for any one or more of the representations, warranties, covenants, agreements or other obligations or liabilities of any one or more of the Company, Acquiror or Merger Sub under this Agreement or any Ancillary Agreement of or for any claim based on, arising out of, or related to this Agreement or the transactions contemplated hereby.

[Table of Contents](#)

11.15 Nonsurvival of Representations, Warranties and Covenants. Except in the case of Fraud, none of the representations, warranties, covenants, obligations or other agreements in this Agreement or in any certificate, statement or instrument delivered pursuant to this Agreement, including any rights arising out of any breach of such representations, warranties, covenants, obligations, agreements and other provisions, shall survive the Closing and shall terminate and expire upon the occurrence of the Effective Time (and there shall be no liability after the Closing in respect thereof), except for (a) those covenants and agreements contained herein or in any Ancillary Agreement that by their terms expressly apply in whole or in part after the Closing and then only with respect to any breaches occurring after the Closing, and (b) this [Article XI](#).

11.16 Stockholder Representative.

(a) Upon approval by the Company Stockholders, each Company Stockholder shall be deemed to have irrevocably appointed the Founder as its representative and attorney-in-fact (in such capacity, the "Stockholder Representative") to serve as the Stockholder Representative for and on behalf of the Company Stockholders with respect to matters relating to the Earnout Shares, including (i) sending or receiving notices or communications, (ii) entering into amendments or providing waivers of this Agreement or other Ancillary Agreements, (iii) making decisions with respect to the distribution and allocation of the Earnout Shares, (iv) retaining counsel, experts and other agents (any representatives so retained, the "Retained Agents"), and (v) entering into any settlement or submitting any dispute relating to the Earnout Shares. Notwithstanding the foregoing, the Stockholder Representative shall have no obligation to act. The Stockholder Representative shall have no liability to any Company Stockholder (or any other Person) with respect to actions taken or omitted to be taken in its capacity as the Stockholder Representative. In the absence of bad faith by the Stockholder Representative, the Stockholder Representative shall be entitled to conclusively rely on the opinions and advice of any Retained Agents; and the fact that any act was taken or omitted to be taken pursuant to the advice of counsel will be conclusive evidence of good faith. The Stockholder Representative may resign at any time after giving 30 days' notice to the Company and the Company Stockholders; provided, however, in the event of the resignation or removal of the Stockholder Representative, a successor stockholder representative shall be appointed by the Founder.

(b) The Stockholder Representative shall be reimbursed by PubCo for any and all reasonable and documented expenses, disbursements, costs and advances (including fees and disbursements of Retained Agents) incurred by the Stockholder Representative in his capacity as such.

(c) To the fullest extent permitted by Law, PubCo shall indemnify the Stockholder Representative and hold the Stockholder Representative harmless against any actions, suits, proceedings, claims, costs, amounts paid in settlement, liabilities, losses, damages, and other expenses arising out of or in connection with the acceptance or administration of the Stockholder Representative's duties hereunder.

(d) A decision, act, consent or instruction of the Stockholder Representative shall constitute a decision of all Company Stockholders and shall be final, binding and conclusive upon all Company Stockholders. Acquiror is hereby entitled to rely on all statements, representations and decisions of the Stockholder Representative and shall have no liability to the Company Stockholders and the Stockholder Representative in connection with any actions taken or not taken in reliance on such statements, representations and decisions of the Stockholder Representative.

11.17 Acknowledgments. Each of the parties acknowledges and agrees (on its own behalf and on behalf of its respective Affiliates and its and their respective Representatives) that: (i) it has conducted its own independent investigation of the financial condition, results of operations, assets, liabilities, properties and projected operations of the other parties (and their respective Subsidiaries) and has been afforded satisfactory access to the books and records, facilities and personnel of the other parties (and their respective Subsidiaries) for purposes of conducting such investigation; (ii) the Company Representations constitute the sole and exclusive representations and warranties of the Company in connection with the transactions contemplated hereby; (iii) the Acquiror and Merger Sub Representations constitute the sole and exclusive representations and warranties of Acquiror and Merger Sub; (iv) except for the Company Representations by the Company, the Acquiror and Merger Sub Representations by Acquiror and Merger

[Table of Contents](#)

Sub, none of the parties hereto or any other Person makes, or has made, any other express or implied representation or warranty with respect to any party hereto (or any party's Affiliates) or the transactions contemplated by this Agreement and all other representations and warranties of any kind or nature expressed or implied (including (x) regarding the completeness or accuracy of, or any omission to state or to disclose, any information, including in the estimates, projections or forecasts or any other information, document or material provided to or made available to any party hereto or their respective Affiliates or Representatives in certain "data rooms," management presentations or in any other form in expectation of the Transactions, including meetings, calls or correspondence with management of any party hereto (or any party's Subsidiaries), and (y) any relating to the future or historical business, condition (financial or otherwise), results of operations, prospects, assets or liabilities of any party hereto (or its Subsidiaries), or the quality, quantity or condition of any party's or its Subsidiaries' assets) are specifically disclaimed by all parties hereto and their respective Subsidiaries and all other Persons (including the Representatives and Affiliates of any party hereto or its Subsidiaries); and (v) each party hereto and its respective Affiliates and its and their respective Representatives are not relying on and have not relied on, any representations or warranties in connection with the Transactions or otherwise except the Company Representations by the Company, the Acquiror and Merger Sub Representations by Acquiror and Merger Sub and the other representations expressly made by a Person in the Sponsor Support Agreement, the Company Support Agreements, the Earnout Escrow Agreement and the Registration Rights Agreement (each of which is being made solely by the Person expressly making such representation in the applicable Ancillary Agreement and not by any other Person).

[signature page follows]

[Table of Contents](#)

IN WITNESS WHEREOF, Acquiror, Merger Sub, the Company and the Stockholder Representative have caused this Agreement to be executed and delivered as of the date first written above.

CLEANTECH ACQUISITION CORP
By: <u> /s/ Eli Spiro </u>
Name: Eli Spiro
Title: Chief Executive Officer

CLEANTECH MERGER SUB, INC.
By: <u> /s/ Eli Spiro </u>
Name: Eli Spiro
Title: Managing Member

NAUTICUS ROBOTICS, INC.
By: <u> /s/ Nicholas A. Radford </u>
Name: Nicholas A. Radford
Title: President and Chief Executive Officer

STOCKHOLDER REPRESENTATIVE
<u> /s/ Nicholas Radford </u>
Name: Nicholas Radford

EXHIBIT D
FORM OF AMENDED AND RESTATED BYLAWS
OF
[NAUTICUS ROBOTICS INC.]

A Texas corporation

Adopted as of __ , 2022

ARTICLE I
OFFICES

Section 1. Registered Office. The registered office of the corporation in the State of Texas shall be located at [____]. The name of its registered agent at such address is [____]. The registered office and/or registered agent of the corporation may be changed from time to time by action of the board of directors.

Section 2. Other Offices. The corporation may also have offices at such other places, both within and without the State of Texas, as the board of directors may from time to time determine or the business of the corporation may require.

ARTICLE II
MEETINGS OF STOCKHOLDERS

Section 1. Meetings Generally. At least one meeting of the stockholders shall be held each year for the purpose of electing directors and conducting any proper business as may come before the meeting. The date, time and place of such meeting shall be determined by the highest ranking officer then in office (the “Ranking Officer”); provided, however, that if the Ranking Officer does not act, the board of directors shall determine the date, time and place, if any, and/or the means of remote communication, of such meeting. Notwithstanding the foregoing, no annual meeting of stockholders need be held if not required by the corporation’s certificate of formation or by the Texas Business Organizations Code (the “TBOC”).

Section 2. Special Meetings. Special meetings of the stockholders may be called for any purpose and may be held at such time and place, within or without the State of Texas, as shall be stated in a written notice of meeting or in a duly executed waiver of notice thereof. Except as otherwise provided in the corporation’s certificate of formation, such meetings may be called at any time by the board of directors or the Ranking Officer and shall be called by the Ranking Officer upon the written request of holders of shares entitled to cast not less than a majority of the votes at the meeting. Such written request shall state the purpose or purposes of the meeting and shall be delivered to the Ranking Officer. Upon such written request, the Ranking Officer shall fix a date, time and place, if any, and/or remote communication, for such meeting within two days of the date requested for such meeting; provided, however, that if the Ranking Officer does not act, the board of directors shall fix a date, time and place, if any, and/or remote communication for such meeting.

Section 3. Place of Meetings. The board of directors may designate any place, either within or without the State of Texas, and/or by means of remote communication, as the place of meeting for any regular meeting or for any special meeting called by the board of directors. If no designation is made, or if a special meeting be otherwise called, the place of meeting shall be the principal executive office of the corporation.

Section 4. Notice. Whenever stockholders are required or permitted to take action at a meeting, written or printed notice stating the place, if any, date, time, means of remote communications, if any, by which stockholders and proxy holders may be deemed to be present in person and vote at such meeting, and, in the case of special meetings, the purpose or purposes, of such meeting, shall be given to each stockholder entitled to vote at such meeting not less than ten (10) nor more than sixty (60) days before the date of the meeting. All such notices shall be delivered, either personally, by mail, by facsimile or by electronic mail, by or at the direction of the board of directors, the president or the secretary, and such notice shall be deemed to be delivered (i) upon confirmation of receipt if sent by facsimile, electronic mail or personal delivery or (ii) three (3) days after being deposited in the United States mail, postage prepaid, addressed to the stockholder at his, her or its address as the same appears on the records of the corporation. Attendance of a person at a meeting shall constitute a waiver of notice of such meeting, except when the person attends for the express purpose of objecting at the beginning of the meeting to the transaction of any business because the meeting is not lawfully called or convened.

Table of Contents

Section 5. Stockholders List. The officer having charge of the stock ledger of the corporation shall make, at least ten (10) days before every meeting of the stockholders, a complete list of the stockholders entitled to vote at such meeting arranged in alphabetical order, showing the address of each stockholder and the number of shares registered in the name of each stockholder. Such list shall be open to the examination of any stockholder, for any purpose germane to the meeting, for a period of at least ten (10) days prior to the meeting: (i) on a reasonably accessible electronic network, provided that the information required to gain access to such list is provided with the notice of the meeting, and/or (ii) during ordinary business hours, at the principal place of business of the corporation. If the corporation determines to make the list available on an electronic network, the corporation may take reasonable steps to ensure that such information is available only to stockholders of the corporation. If the meeting is to be held at a place, then the list shall be produced and kept at the time and place of the meeting during the whole time thereof, and may be inspected by any stockholder who is present. If the meeting is to be held solely by means of remote communication, then the list shall also be open to the examination of any stockholder during the whole time of the meeting on a reasonably accessible electronic network, and the information required to access such list shall be provided with the notice of the meeting.

Section 6. Quorum. The holders of at least a majority of the issued and outstanding shares of capital stock entitled to vote thereon, present in person or represented by proxy, shall constitute a quorum at all meetings of the stockholders, except as otherwise provided by statute or by the corporation's certificate of formation. If a quorum is not present, the holders of a majority of the shares present in person or represented by proxy at the meeting, and entitled to vote at the meeting, may adjourn the meeting to another time and/or place. When a quorum is once present to commence a meeting of stockholders, it is not broken by the subsequent withdrawal of any stockholders or their proxies.

Section 7. Adjourned Meetings. When a meeting is adjourned to another time and place, notice need not be given of the adjourned meeting if the time, place, if any, thereof, and the means of remote communications, if any, by which stockholders and proxy holders may be deemed to be present in person and vote at such adjourned meeting are announced at the meeting at which the adjournment is taken. At the adjourned meeting the corporation may transact any business which might have been transacted at the original meeting. If the adjournment is for more than thirty (30) days, or if after the adjournment a new record date is fixed for the adjourned meeting, a notice of the adjourned meeting shall be given to each stockholder of record entitled to vote at the meeting.

Section 8. Vote Required. When a quorum is present, the affirmative vote of the majority of shares present in person or represented by proxy at the meeting and entitled to vote on the subject matter shall be the act of the stockholders, unless the question is one upon which by express provisions of an applicable law or of the corporation's certificate of formation a different vote is required, in which case such express provision shall govern and control the decision of such question.

Section 9. Voting Rights. Except as otherwise provided by the TBOC or by the corporation's certificate of formation or any amendments thereto and subject to Section 3 of Article VI hereof, every stockholder shall at every meeting of the stockholders be entitled to one (1) vote in person or by proxy for each share of common stock held (or deemed held) by such stockholder (it being understood that certain other classes or series of capital stock may, pursuant to the corporation's certificate of formation, be entitled to vote on as as-if converted to common stock basis).

Section 10. Proxies. Each stockholder entitled to vote at a meeting of the stockholders or to express consent or dissent to corporate action in writing without a meeting may authorize another person or persons to act for such stockholder by proxy, but no such proxy shall be voted or acted upon after three (3) years from its date, unless the proxy provides for a longer period. A duly executed proxy shall be irrevocable if it states that it is irrevocable and if, and only as long as, it is coupled with an interest sufficient in law to support an irrevocable power. A proxy may be made irrevocable regardless of whether the interest with which it is coupled is an interest in the stock itself or an interest in the corporation generally. Any proxy is suspended when the person executing the proxy is present at a meeting of the stockholders and elects to vote, except that, when such proxy is coupled with an interest and the fact of the interest appears on the face of the proxy, the agent named in the proxy shall have all voting and other rights referred to in the proxy, notwithstanding the presence of the person executing the proxy. At each meeting of the stockholders, and before any voting commences, all proxies filed at or before the meeting shall be submitted to and examined by the secretary or a person designated by the secretary and no shares may be represented or voted under a proxy that has been found to be invalid or irregular.

Section 11. Action by Written Consent. Unless otherwise provided in the corporation's certificate of formation, any action required to be taken at any regular or special meeting of stockholders of the corporation, or any action which may be taken at any regular or special meeting of such stockholders, may be taken without a meeting, without prior notice and without a vote, if a consent or consents in writing, setting forth the action so taken and bearing the dates of signature of the stockholders who signed the consent or consents, shall be signed by the holders of outstanding stock having not less than the minimum number of votes that would be necessary to authorize or take such action at a meeting at which all shares entitled to vote thereon were present and voted and shall be delivered to the corporation by delivery to its registered office in the state of Texas, or the corporation's principal place of business, or an officer or agent of the corporation having custody of the book or books in which proceedings of meetings of the stockholders are recorded. Delivery made to the corporation's registered office shall be by hand or by certified or registered mail, return receipt requested, by reputable overnight courier service, or by facsimile or electronic mail, with confirmation of receipt. All consents properly delivered in accordance with this section shall be deemed to be recorded when so delivered. No written consent shall be effective to take the corporate action referred to therein unless, within sixty (60) days of the earliest dated consent delivered to the corporation as required by this section, written consents signed by the holders of a sufficient number of shares to take such corporate action are so recorded. Any action taken pursuant to such written consent or consents of the stockholders shall have the same force and effect as if taken by the stockholders at a meeting thereof.

Any copy, facsimile or other reliable reproduction of a consent in writing may be substituted or used in lieu of the original writing for any and all purposes for which the original writing could be used; provided that such copy, facsimile or other reproduction shall be a complete reproduction of the entire original writing.

ARTICLE III DIRECTORS

Section 1. General Power. The business and affairs of the corporation shall be managed by or under the direction of the board of directors.

Section 2. Number, Election and Term of Office. The number of directors which shall constitute the first board shall be two (2). The number of directors shall be subject to change by the vote of holders of a majority of the stock then entitled to vote at an election of directors. The directors shall be elected by a plurality of the votes of the stock present in person or represented by proxy at a meeting of the stockholders and entitled to vote in the election of directors. The directors shall be elected in this manner at any meeting of the stockholders, except as provided in Section 4 of this Article III. Each director elected shall hold office until a successor is duly elected and qualified or until his or her earlier death, resignation or removal as hereinafter provided.

Section 3. Removal and Resignation. Any director or the entire board of directors may be removed at any time, with or without cause, by the holders of a majority of the shares then entitled to vote at an election of directors. Whenever the holders of any class or series are entitled to elect one or more directors by the provisions of the corporation's certificate of formation, the provisions of this section shall apply, in respect to the removal without cause of a director or directors so elected, to the vote of the holders of the outstanding shares of that class or series and not to the vote of the outstanding shares as a whole. Any director may resign at any time upon notice given in writing or by electronic transmission to the corporation.

Section 4. Vacancies. Except as otherwise provided in the corporation's certificate of formation, board vacancies and newly created directorships resulting from any increase in the authorized number of directors shall be filled in the same manner in which directors are elected pursuant to Section 2 of this Article III. Notwithstanding the foregoing, any such vacancy shall automatically reduce the number of directors *pro tanto*, until such time as the holders of the class of common stock which was entitled to elect the director whose office is vacant shall have exercised their right to elect a director to fill such vacancy, whereupon the number of directors shall be automatically increased *pro tanto*. Each director so chosen shall hold office until a successor is duly elected and qualified or until his or her earlier death, resignation or removal as herein provided.

Section 5. Meetings and Notice. Regular meetings of the board of directors may be held without notice at such time and at such place as shall from time to time be determined by resolution of the board or directors and promptly communicated to all directors then in the office. Special meetings of the board of directors may be called by or at the request of any director or the Ranking Officer on at least forty- eight (48) hours' notice to each director, either personally, by telephone, by mail, or by facsimile or electronic mail.

Table of Contents

Section 6. Quorum, Required Vote and Adjournment. Each director shall be entitled to one vote except as otherwise provided in the corporation's certificate of formation. Directors then in office (and specifically excluding any vacancies) and holding a majority of the votes of all directors (or such greater number required by applicable law) shall constitute a quorum for the transaction of business. The vote of directors holding a majority of votes present at a meeting at which a quorum is present shall be the act of the board of directors. If a quorum shall not be present at any meeting of the board of directors, the directors present thereat may adjourn the meeting from time to time, without notice other than announcement at the meeting, until a quorum shall be present.

Section 7. Committees. The board of directors may, by resolution passed by a majority of the whole board, designate one or more committees, each committee to consist of one or more of the directors of the corporation, which to the extent provided in such resolution or these Amended and Restated Bylaws shall have and may exercise the powers of the board of directors in the management and affairs of the corporation except as otherwise limited by law. The board of directors may designate one or more directors as alternate members of any committee, who may replace any absent or disqualified member at any meeting of the committee. Such committee or committees shall have such name or names as may be determined from time to time by resolution adopted by the board of directors. Each committee shall keep regular minutes of its meetings and report the same to the board of directors when required.

Section 8. Committee Rules. Each committee of the board of directors may fix its own rules of procedure and shall hold its meetings as provided by such rules, except as may otherwise be provided by a resolution of the board of directors designating such committee. Unless otherwise provided in such a resolution, the presence of at least a majority of the members of the committee shall be necessary to constitute a quorum. If a member and that member's alternate, if alternates are designated by the board of directors as provided in Section 7 of this Article III, of such committee is or are absent or disqualified, the member or members thereof present at any meeting and not disqualified from voting, whether or not such member or members constitute a quorum, may unanimously appoint another member of the board of directors to act at the meeting in place of any such absent or disqualified member.

Section 9. Communications Equipment. Members of the board of directors or any committee thereof may participate in and act at any meeting of such board or committee through the use of a conference telephone or other communications equipment by means of which all persons participating in the meeting can hear each other, and participation in the meeting pursuant to this Section shall constitute presence in person at the meeting.

Section 10. Waiver of Notice and Presumption of Consent. Any member of the board of directors or any committee thereof who is present at a meeting shall be conclusively presumed to have waived notice of such meeting except, when such member attends for the express purpose of objecting at the beginning of the meeting to the transaction of any business because the meeting is not lawfully called or convened. Such member shall be conclusively presumed to have consented to any action taken unless his or her dissent shall be entered in the minutes of the meeting or unless his or her written dissent to such action shall be filed with the person acting as the secretary of the meeting before the adjournment thereof or shall be forwarded by registered mail to the secretary of the corporation immediately after the adjournment of the meeting. Such right to dissent shall not apply to any member who voted in favor of such action.

Section 11. Action by Written Consent. Unless otherwise restricted by the corporation's certificate of formation, any action required or permitted to be taken at any meeting of the board of directors, or of any committee thereof, may be taken without a meeting if all members of the board or committee, as the case may be, consent thereto in writing or by electronic transmission, and the writing or writings or electronic transmission or transmissions are filed with the minutes of proceedings of the board or committee. Such filing shall be in paper form if the minutes are maintained in paper form and shall be in electronic form if the minutes are maintained in electronic form.

ARTICLE IV OFFICERS

Section 1. Number. The officers of the corporation shall be elected by the board of directors and may consist of a chairman of the board, a president, a chief executive officer, a chief financial officer, one or more vice presidents, a secretary, a treasurer, and such other officers and assistant officers as may be deemed necessary or desirable by the board of directors. Any number of offices may be held by the same person. In its discretion, the board of directors may choose not to fill any office for any period as it may deem advisable, except that the offices of president and secretary shall be filled as expeditiously as reasonably possible.

Table of Contents

Section 2. Election and Term of Office. The officers of the corporation shall be elected at any meeting of the board of directors. Vacancies may be filled or new offices created and filled at any meeting of the board of directors. Each officer shall hold office until a successor is duly elected and qualified or until his or her earlier death, resignation or removal as hereinafter provided.

Section 3. Removal. Any officer or agent elected by the board of directors may be removed by the board of directors whenever in its judgment the best interests of the corporation would be served thereby, but such removal shall be without prejudice to the contract rights, if any, of the person so removed.

Section 4. Vacancies. Any vacancy occurring in any office because of death, resignation, removal, disqualification or otherwise, may be filled by the board of directors for the unexpired portion of the term by the board of directors then in office.

Section 5. Compensation. Compensation of all officers shall be fixed by the board of directors, and no officer shall be prevented from receiving such compensation by virtue of his or her also being a director of the corporation.

Section 6. Chairman of the Board. The chairman of the board, if one is appointed, shall have the powers and perform the duties incident to that position. Subject to the powers of the board of directors, he or she shall be in the general and active charge of the entire business and affairs of the corporation. He or she shall preside at meetings of the board of directors and the stockholders and shall have such other powers and perform such other duties as may be prescribed by the board of directors or provided in these Amended and Restated Bylaws. Whenever the president is unable to serve, by reason of sickness, absence or otherwise, the chairman of the board shall perform all the duties and responsibilities and exercise all the powers of the president.

Section 7. The President. The president shall be the chief executive officer of the corporation; shall preside at all meetings of the stockholders and board of directors at which he or she is present; subject to the powers of the board of directors, shall have general charge of the business, affairs and property of the corporation, and control over its officers, agents and employees; and shall see that all orders and resolutions of the board of directors are carried into effect. The president shall execute bonds, mortgages and other contracts which the board of directors has authorized to be executed, except where required or permitted by law to be otherwise signed and executed and except where the signing and execution thereof shall be expressly delegated by the board of directors to some other officer or agent of the corporation. The president shall have such other powers and perform such other duties as may be prescribed by the board of directors or as may be provided in these Amended and Restated Bylaws. If there is no chief executive officer, the president shall also have the duties of the chief executive officer as prescribed above.

Section 8. Chief Financial Officer. The chief financial officer of the corporation, if one is appointed, shall, under the direction of the chief executive officer (or, in the absence of a chief executive officer, the president), be responsible for all financial and accounting matters and for the direction of the offices of treasurer and controller. The chief financial officer shall have such other powers and perform such other duties as may be prescribed by the chairman of the board, the chief executive officer (or, in the absence of a chief executive officer, the president) or the board of directors or as may be provided in these Amended and Restated Bylaws.

Section 9. Vice Presidents. The vice president, if one is appointed, or if there shall be more than one, the vice presidents in the order determined by the board of directors or by the president, shall, in the absence or disability of the president, act with all of the powers and be subject to all the restrictions of the president. The vice presidents shall also perform such other duties and have such other powers as the board of directors, the chief executive officer (or, in the absence of a chief executive officer, the president) or these Amended and Restated Bylaws may, from time to time, prescribe.

Section 10. The Secretary and Assistant Secretaries. The secretary shall attend all meetings of the board of directors, all meetings of the committees thereof and all meetings of the stockholders and record all the proceedings of the meetings in a book or books to be kept for that purpose. Under the chief executive officer's (or, in the absence of a chief executive officer, the president's) supervision, the secretary shall give, or cause to be given, all notices required to be given by these Amended and Restated Bylaws or by law; shall have such powers and perform such duties as the board of directors, the chief executive officer (or, in the absence of a chief executive officer, the president) or these Amended and Restated Bylaws may, from time to time, prescribe; and shall have custody of the corporate seal of the corporation. The secretary, or an assistant secretary, shall have authority to affix the corporate seal to any instrument requiring it and when so affixed, it may be attested by his or her signature or by the signature of such assistant secretary.

[Table of Contents](#)

The board of directors may give general authority to any other officer to affix the seal of the corporation and to attest the affixing by his or her signature. The assistant secretary, or if there be more than one, the assistant secretaries in the order determined by the board of directors, shall, in the absence or disability of the secretary, perform the duties and exercise the powers of the secretary and shall perform such other duties and have such other powers as the board of directors, the chief executive officer (or, in the absence of a chief executive officer, the president) or the secretary may, from time to time, prescribe.

Section 11. The Treasurer and Assistant Treasurer. The treasurer shall, subject to the authority of the chief financial officer, if one is appointed, have the custody of the corporate funds and securities; shall keep full and accurate accounts of receipts and disbursements in books belonging to the corporation; shall deposit all monies and other valuable effects in the name and to the credit of the corporation as may be ordered by the board of directors; shall cause the funds of the corporation to be disbursed when such disbursements have been duly authorized, taking proper vouchers for such disbursements; shall render to the chief executive officer (or, in the absence of a chief executive officer, the president) and the board of directors, at its regular meeting or when the board of directors so requires, an account of the corporation; and shall have such powers and perform such duties as the board of directors, the chief executive officer (or, in the absence of a chief executive officer, the president) or these Amended and Restated Bylaws may, from time to time, prescribe. If required by the board of directors, the treasurer shall give the corporation a bond (which shall be rendered every six (6) years) in such sums and with such surety or sureties as shall be satisfactory to the board of directors for the faithful performance of the duties of the office of treasurer and for the restoration to the corporation, in case of death, resignation, retirement, or removal from office, of all books, papers, vouchers, money, and other property of whatever kind in the possession or under the control of the treasurer belonging to the corporation. The assistant treasurer, or if there shall be more than one, the assistant treasurers in the order determined by the board of directors, shall in the absence or disability of the chief financial officer or treasurer, perform the duties and exercise the powers of the treasurer. The assistant treasurers shall perform such other duties and have such other powers as the board of directors, the chief executive officer (or, in the absence of a chief executive officer, the president) or the treasurer may, from time to time, prescribe.

Section 12. Other Officers, Assistant Officers and Agents. Officers, assistant officers and agents, if any, other than those whose duties are provided for in these Amended and Restated Bylaws, shall have such authority and perform such duties as may from time to time be prescribed by resolution of the board of directors.

Section 13. Absence or Disability of Officers. In the case of the absence or disability of any officer of the corporation and of any person hereby authorized to act in such officer's place during such officer's absence or disability, the board of directors may by resolution delegate the powers and duties of such officer to any other officer or to any director, or to any other person whom it may select.

ARTICLE V
INDEMNIFICATION OF OFFICERS, DIRECTORS AND OTHERS

Section 1. Power to Indemnify in Actions, Suits or Proceedings other than Those by or in the Right of the Corporation. Subject to Section 3 of this Article V, the corporation shall indemnify any person who was or is a party or is threatened to be made a party to any threatened, pending or completed action, suit or proceeding, whether civil, criminal, administrative or investigative (other than an action by or in the right of the corporation) by reason of the fact that such person is or was a director or officer of the corporation, or, while a director or officer of the corporation, is or was serving at the request of the corporation as a director, officer, employee or agent of another corporation, partnership, joint venture, trust, employee benefit plan or other enterprise, against expenses (including attorneys' fees), judgments, fines and amounts paid in settlement actually and reasonably incurred by such person in connection with such action, suit or proceeding if such person acted in good faith and in a manner such person reasonably believed to be in or not opposed to the best interests of the corporation, and, with respect to any criminal action or proceeding, had no reasonable cause to believe such person's conduct was unlawful. The termination of any action, suit or proceeding by judgment, order, settlement, conviction, or upon a plea of nolo contendere or its equivalent, shall not, of itself, create a presumption that the person did not act in good faith and in a manner which such person reasonably believed to be in or not opposed to the best interests of the corporation, and, with respect to any criminal action or proceeding, had reasonable cause to believe that such person's conduct was unlawful.

Section 2. Power to Indemnify in Actions, Suits or Proceedings by or in the Right of the Corporation Subject to Section 3 of this Article V, the corporation shall indemnify any person who was or is a party or is threatened to be made a party to any threatened, pending or completed action or suit by or in the right of the corporation to procure a

judgment in its favor by reason of the fact that such person is or was a director or officer of the corporation, or, while a director or officer of the corporation, is or was serving at the request of the corporation as a director, officer, employee or agent of another corporation, partnership, joint venture, trust, employee benefit plan or other enterprise against expenses (including attorneys' fees) actually and reasonably incurred by such person in connection with the defense or settlement of such action or suit if such person acted in good faith and in a manner such person reasonably believed to be in or not opposed to the best interests of the corporation; except that no indemnification shall be made in respect of any claim, issue or matter as to which such person shall have been adjudged to be liable to the corporation unless and only to the extent that the court in which such action or suit was brought shall determine upon application that, despite the adjudication of liability but in view of all the circumstances of the case, such person is fairly and reasonably entitled to indemnity by the corporation for such expenses which the court shall deem proper.

Section 3. Authorization of Indemnification. Any indemnification under this Article V (unless ordered by a court) shall be made by the corporation only as authorized in the specific case upon a determination that indemnification of the director or officer is proper in the circumstances because such person has met the applicable standard of conduct set forth in Section 1 or Section 2 of this Article V, as the case may be. Such determination shall be made, with respect to a person who is a director or officer at the time of such determination, (i) by a majority vote of the directors who are not parties to such action, suit or proceeding, even though less than a quorum, or (ii) by a committee of such directors designated by a majority vote of such directors, even though less than a quorum, or (iii) if there are no such directors, or if such directors so direct, by independent legal counsel in a written opinion or (iv) by the stockholders. Such determination shall be made, with respect to former directors and officers, by any person or persons having the authority to act on the matter on behalf of the corporation. To the extent, however, that a present or former director or officer of the corporation has been successful on the merits or otherwise in defense of any action, suit or proceeding set forth in Section 1 or Section 2 of this Article V or in defense of any claim, issue or matter therein, such person shall be indemnified against expenses (including attorneys' fees) actually and reasonably incurred by such person in connection therewith, without the necessity of authorization in the specific case.

Section 4. Good Faith Defined. For purposes of any determination under Section 3 of this Article V, a person shall, to the fullest extent permitted by law, be deemed to have acted in good faith and in a manner such person reasonably believed to be in or not opposed to the best interests of the corporation, or, with respect to any criminal action or proceeding, to have had no reasonable cause to believe such person's conduct was unlawful, if such person's action is based on good faith reliance on the records or books of account of the corporation or another enterprise, or on information supplied to such person by the officers of the corporation or another enterprise in the course of their duties, or on the advice of legal counsel for the corporation or another enterprise or on information or records given or reports made to the corporation or another enterprise by an independent certified public accountant or by an appraiser or other expert selected with reasonable care by the corporation or another enterprise. The term "another enterprise" as used in this Section 4 shall mean any other corporation or any partnership, joint venture, trust, employee benefit plan or other enterprise of which such person is or was serving at the request of the corporation as a director, officer, employee or agent. The provisions of this Section 4 shall not be deemed to be exclusive or to limit in any way the circumstances in which a person may be deemed to have met the applicable standard of conduct set forth in Section 1 or Section 2 of this Article V, as the case may be.

Section 5. Right of Claimant to Bring Suit. Notwithstanding any contrary determination in the specific case under Section 3 of this Article V, and notwithstanding the absence of any determination thereunder, if (i) following the final disposition of the applicable proceeding, a claim for indemnification under Section 1 or Section 2 of this Article V is not paid in full by the corporation within ninety (90) days after the later of a written claim for indemnification has been received by the corporation, or (ii) a claim for advancement of expenses under Section 6 of this Article V is not paid in full by the corporation within thirty (30) days after the corporation has received a statement or statements requesting such amounts to be advanced, the claimant may at any time thereafter (but not before) bring suit against the corporation in the federal courts of the United States or the courts of the State of Texas, in each case located in the County of Harris, to recover the unpaid amount of the claim, together with interest thereon, or to obtain advancement of expenses, as applicable. It shall be a defense to any such action brought to enforce a right to indemnification (but not in an action brought to enforce a right to an advancement of expenses) that the claimant has not met the standards of conduct which make it permissible under the TBOC (or other applicable law) for the corporation to indemnify the claimant for the amount claimed, but the burden of proving such defense shall be on the corporation. Neither a contrary determination in the specific case under Section 3 of this Article V nor the absence of any determination thereunder shall be a defense to such application or create a presumption that the claimant has not met any applicable

[Table of Contents](#)

standard of conduct. If successful, in whole or in part, the claimant shall also be entitled to be paid the expense of prosecuting such claim, including reasonable attorneys' fees incurred in connection therewith, to the fullest extent permitted by applicable law.

Section 6. Expenses Payable in Advance. Expenses, including without limitation attorneys' fees, incurred by a current or former director or officer in defending any civil, criminal, administrative or investigative action, suit or proceeding to which such person is a party or is threatened to be made a party or otherwise involved as a witness or otherwise, by reason of the fact that such person is or was a director or officer of the corporation, or, while a director or officer of the corporation, is or was serving at the request of the corporation as a director, officer, employee or agent of another corporation, partnership, joint venture, trust, employee benefit plan or other enterprise, shall be paid by the corporation in advance of the final disposition of such action, suit or proceeding upon receipt of an undertaking by or on behalf of such current or former director or officer to repay such amount if it shall ultimately be determined that such person is not entitled to be indemnified by the corporation as authorized in this Article V or otherwise.

Section 7. Nonexclusivity of Indemnification and Advancement of Expenses. The rights to indemnification and advancement of expenses provided by or granted pursuant to this Article V shall not be deemed exclusive of any other rights to which those seeking indemnification or advancement of expenses may be entitled under the certificate of formation, any agreement, vote of stockholders or disinterested directors or otherwise, both as to action in such person's official capacity and as to action in another capacity while holding such office, it being the policy of the corporation that, subject to Section 11 of this Article V, indemnification of the persons specified in Section 1 or Section 2 of this Article V shall be made to the fullest extent permitted by law. The provisions of this Article V shall not be deemed to preclude the indemnification of any person who is not specified in Section 1 or Section 2 of this Article V but whom the corporation has the power or obligation to indemnify under the provisions of the TBOC, or otherwise.

Section 8. Insurance. The corporation may purchase and maintain insurance on behalf of any person who is or was a director, officer, employee or agent of the corporation, or is or was serving at the request of the corporation as a director, officer, employee or agent of another corporation, partnership, joint venture, trust, employee benefit plan or other enterprise against any liability asserted against such person and incurred by such person in any such capacity, or arising out of such person's status as such, whether or not the corporation would have the power or the obligation to indemnify such person against such liability under the provisions of this Article V.

Section 9. Certain Definitions. For purposes of this Article V, references to "the corporation" shall include, in addition to the resulting corporation, any constituent corporation (including any constituent of a constituent) absorbed in a consolidation or merger which, if its separate existence had continued, would have had power and authority to indemnify its directors, officers, employees or agents so that any person who is or was a director or officer of such constituent corporation, or, while a director or officer of such constituent corporation, is or was serving at the request of such constituent corporation as a director, officer, employee or agent of another corporation, partnership, joint venture, trust, employee benefit plan or other enterprise, shall stand in the same position under the provisions of this Article V with respect to the resulting or surviving corporation as such person would have with respect to such constituent corporation if its separate existence had continued. For purposes of this Article V, references to "fines" shall include any excise taxes assessed on a person with respect to any employee benefit plan; and references to "serving at the request of the corporation" shall include any service as a director, officer, employee or agent of the corporation which imposes duties on, or involves services by, such director, officer, employee or agent with respect to an employee benefit plan, its participants or beneficiaries; and a person who acted in good faith and in a manner such person reasonably believed to be in the interest of the participants and beneficiaries of an employee benefit plan shall be deemed to have acted in a manner "not opposed to the best interests of the corporation" as referred to in this Article V.

Section 10. Survival of Indemnification and Advancement of Expenses. The indemnification and advancement of expenses provided by, or granted pursuant to, this Article V shall continue as to a person who has ceased to be a director or officer and shall inure to the benefit of the heirs, executors and administrators of such a person.

Section 11. Limitation on Indemnification. Notwithstanding anything contained in this Article V to the contrary, except for proceedings to enforce rights to indemnification or advancement of expenses (which shall be governed by Section 5 of this Article V), the corporation shall not be obligated to indemnify any current or former director or officer in connection with an action, suit proceeding (or part thereof) initiated by such person unless such action, suit or proceeding (or part thereof) was authorized by the Board.

Section 12. Contract Rights. The obligations of the corporation under this Article V to indemnify, and advance expenses to, a person who is or was a director or officer of the corporation shall be considered a contract between the corporation and such person, and no modification or repeal of any provision of this Article V shall affect, to the detriment of such person, such obligations of the corporation in connection with a claim based on any act or failure to act occurring before such modification or repeal.

ARTICLE VI
CERTIFICATES OF STOCK

Section 1. Form. Every holder of stock in the corporation shall be entitled to have a certificate, signed by the chief executive officer (or, in the absence of a chief executive officer, the president), the chief financial officer or a vice president and the secretary or an assistant secretary of the corporation, certifying the number of shares of a specific class or series owned by such holder in the corporation. If such a certificate is countersigned (1) by a transfer agent or an assistant transfer agent other than the corporation or its employee or (2) by a registrar, other than the corporation or its employee, the signature of any such chief executive officer (or, in the absence of a chief executive officer, the president), chief financial officer, vice president, secretary, or assistant secretary may be facsimiles. In case any officer or officers who have signed, or whose facsimile signature or signatures have been used on, any such certificate or certificates shall cease to be such officer or officers of the corporation whether because of death, resignation or otherwise before such certificate or certificates have been delivered by the corporation, such certificate or certificates may nevertheless be issued and delivered as though the person or persons who signed such certificate or certificates or whose facsimile signature or signatures have been used thereon had not ceased to be such officer or officers of the corporation. All certificates for shares shall be consecutively numbered or otherwise identified. The name of the person to whom the shares represented thereby are issued, with the number of shares and date of issue, shall be entered on the books of the corporation. Shares of stock of the corporation shall be transferred on the books of the corporation only by the holder of record thereof or by such holder's attorney duly authorized in writing, upon surrender to the corporation of the certificate or certificates for such shares endorsed by the appropriate person or persons, with such evidence of the authenticity of such endorsement, transfer, authorization, and other matters as the corporation may reasonably require, and accompanied by all necessary stock transfer stamps. In that event, it shall be the duty of the corporation to issue a new certificate to the person entitled thereto, cancel the old certificate or certificates, and record the transaction on its books. The board of directors may appoint a bank or trust company organized under the laws of the United States or any state thereof to act as its transfer agent or registrar, or both in connection with the transfer of any class or series of securities of the corporation.

Section 2. Lost Certificates. The board of directors may direct a new certificate or certificates to be issued in place of any certificate or certificates previously issued by the corporation alleged to have been lost, stolen, or destroyed, upon the making of an affidavit of that fact by the person claiming the certificate of stock to be lost, stolen, or destroyed. When authorizing such issue of a new certificate or certificates, the board of directors may, in its discretion and as a condition precedent to the issuance thereof, require the owner of such lost, stolen, or destroyed certificate or certificates, or his or her legal representative, to give the corporation a bond sufficient to indemnify the corporation against any claim that may be made against the corporation on account of the loss, theft or destruction of any such certificate or the issuance of such new certificate.

Section 3. Fixing a Record Date for Stockholder Meetings. In order that the corporation may determine the stockholders entitled to notice of or to vote at any meeting of stockholders or any adjournment thereof, the board of directors may fix a record date, which record date shall not precede the date upon which the resolution fixing the record date is adopted by the board of directors, and which record date shall not be more than sixty (60) nor less than ten (10) days before the date of such meeting. If no record date is fixed by the board of directors, the record date for determining stockholders entitled to notice of or to vote at a meeting of stockholders shall be the close of business on the next day preceding the day on which notice is given, or if notice is waived, at the close of business on the day next preceding the day on which the meeting is held. A determination of stockholders of record entitled to notice of or to vote at a meeting of stockholders shall apply to any adjournment of the meeting; provided that the board of directors may fix a new record date for the adjourned meeting.

Section 4. Fixing a Record Date for Action by Written Consent. In order that the corporation may determine the stockholders entitled to consent to corporate action in writing without a meeting, the board of directors may fix a record date, which record date shall not precede the date upon which the resolution fixing the record date is adopted by the board of directors, and which date shall not be more than ten (10) days after the date upon which the resolution

[Table of Contents](#)

fixing the record date is adopted by the board of directors. If no record date has been fixed by the board of directors, the record date for determining stockholders entitled to consent to corporate action in writing without a meeting, when no prior action by the board of directors is required by statute, shall be the first date on which a signed written consent setting forth the action taken or proposed to be taken is delivered to the corporation by delivery to its registered office in the State of Texas, its principal place of business, or an officer or agent of the corporation having custody of the book in which proceedings of meetings of stockholders are recorded. Delivery made to the corporation's registered office shall be by hand or by certified or registered mail, return receipt requested or by facsimile or electronic mail, with confirmation of receipt. If no record date has been fixed by the board of directors and prior action by the board of directors is required by statute, the record date for determining stockholders entitled to consent to corporate action in writing without a meeting shall be at the close of business on the day on which the board of directors adopts the resolution taking such prior action.

Section 5. Fixing a Record Date for Other Purposes. In order that the corporation may determine the stockholders entitled to receive payment of any dividend or other distribution or allotment or any rights or the stockholders entitled to exercise any rights in respect of any change, conversion or exchange of stock, or for the purposes of any other lawful action, the board of directors may fix a record date, which record date shall not precede the date upon which the resolution fixing the record date is adopted, and which record date shall be not more than sixty (60) days prior to such action. If no record date is fixed, the record date for determining stockholders for any such purpose shall be at the close of business on the day on which the board of directors adopts the resolution relating thereto.

Section 6. Registered Stockholders. Prior to the surrender to the corporation of the certificate or certificates for a share or shares of stock with a request to record the transfer of such share or shares, the corporation may treat the registered owner as the person entitled to receive dividends, to vote, to receive notifications, and otherwise to exercise all the rights and powers of an owner. The corporation shall not be bound to recognize any equitable or other claim to or interest in such share or shares on the part of any other person, whether or not it shall have express or other notice thereof.

Section 7. Subscriptions for Stock. Unless otherwise provided for in the applicable subscription agreement, subscriptions for shares shall be paid in full at such time, or in such installments and at such times, as shall be determined by the board of directors. Any call made by the board of directors for payment on subscriptions shall be uniform as to all shares of the same class or as to all shares of the same series. In case of default in the payment of any installment or call when such payment is due, the corporation may proceed to collect the amount due in the same manner as any debt due the corporation.

ARTICLE VII
GENERAL PROVISIONS

Section 1. Dividends. Dividends upon the capital stock of the corporation, subject to the provisions of the corporation's certificate of formation, if any, may be declared by the board of directors at any regular or special meeting, pursuant to law. Dividends may be paid in cash, in property, or in shares of capital stock, subject to the provisions of the corporation's certificate of formation. Before payment of any dividend, there may be set aside out of any funds of the corporation available for dividends such sum or sums as the directors from time to time, in their absolute discretion, think proper as a reserve or reserves to meet contingencies, or for equalizing dividends, or for repairing or maintaining any property of the corporation, or any other purpose, and the directors may modify or abolish any such reserve in the manner in which it was created.

Section 2. Checks, Drafts or Orders. All checks, drafts, or other orders for the payment of money by or to the corporation and all notes and other evidences of indebtedness issued in the name of the corporation shall be signed by such officer(s) or agent(s) of the corporation, and in such manner, as shall be determined by resolution of the board of directors or a duly authorized committee thereof.

Section 3. Contracts. The board of directors may authorize any officer or officers, or any agent or agents, of the corporation to enter into any contract or to execute and deliver any instrument in the name of and on behalf of the corporation, and such authority may be general or confined to specific instances.

Section 4. Loans. The corporation may lend money to, or guarantee any obligation of, or otherwise assist any officer or other employee of the corporation or of its subsidiary, including any officer or employee who is a director of the corporation or its subsidiary, whenever, in the judgment of the directors, such loan, guaranty or assistance may

[Table of Contents](#)

reasonably be expected to benefit the corporation. The loan, guaranty or other assistance may be with or without interest, and may be unsecured, or secured in such manner as the board of directors shall approve, including, without limitation, a pledge of shares of stock of the corporation. Nothing in this section contained shall be deemed to deny, limit or restrict the powers of guaranty or warranty of the corporation at common law or under any statute.

Section 5. Fiscal Year. The fiscal year of the corporation shall be fixed by resolution of the board of directors.

Section 6. Corporate Seal. The board of directors may provide a corporate seal which shall be in the form of a circle and shall have inscribed thereon the name of the corporation and the words "Corporate Seal, Texas." The seal may be used by causing it or a facsimile thereof to be impressed or affixed or reproduced or otherwise.

Section 7. Voting Securities Owned By Corporation. Voting securities in any other corporation held by the corporation shall be voted by the president, any vice president, the chief financial officer or the secretary, unless the board of directors specifically confers authority to vote with respect thereto, which authority may be general or confined to specific instances, upon some other person or officer. Any person authorized to vote securities shall have the power to appoint proxies, with general power of substitution.

Section 8. Inspection of Books and Records. Any stockholder of record, in person or by attorney or other agent, shall, upon written demand under oath stating the purpose thereof, have the right during the usual hours for business to inspect for any proper purpose the corporation's stock ledger, a list of its stockholders, and its other books and records, and to make copies or extracts therefrom. A proper purpose shall mean any purpose reasonably related to such person's interest as a stockholder. In every instance where an attorney or other agent shall be the person who seeks the right to inspection, the demand under oath shall be accompanied by a power of attorney or such other writing which authorizes the attorney or other agent to so act on behalf of the stockholder. The demand under oath shall be directed to the corporation at its registered office in the State of Texas or at its principal place of business.

Section 9. Exclusive Jurisdiction. The federal courts of the United States or the courts of the State of Texas, in each case located in the County of Harris, shall be the sole and exclusive forum from (i) any derivative action or proceeding brought on behalf of the corporation, (ii) any action asserting a claim of breach of a fiduciary duty owed by any director or officer of the corporation to the corporation arising pursuant to any provision of the TBOC or the corporation's certificate of formation or Amended and Restated Bylaws or (iv) any action asserting a claim against the corporation governed by the internal affairs doctrine.

Section 10. Section Headings. Section headings in these Amended and Restated Bylaws are for convenience of reference only and shall not be given any substantive effect in limiting or otherwise construing any provision herein.

Section 11. Inconsistent Provisions. If any provision of these Amended and Restated Bylaws is or becomes inconsistent with any provision of the corporation's certificate of formation, the TBOC or any other applicable law, the provision of these Amended and Restated Bylaws shall not be given any effect to the extent of such inconsistency but shall otherwise be given full force and effect.

ARTICLE VIII
AMENDMENTS

Except for Article III and Article V hereof, these Amended and Restated Bylaws may be amended, altered, or repealed and new Amended and Restated Bylaws adopted at any meeting of the board of directors by a majority vote. Article III and Article V hereof may be amended, altered, or repealed at any meeting of the board of directors only by a unanimous vote (or unanimous written consent in lieu thereof). The fact that the power to adopt, amend, alter, or repeal the Amended and Restated Bylaws has been conferred upon the board of directors shall not divest the stockholders of the same powers.

* * * * *

EXHIBIT E
FORM OF THE
[•]¹ AMENDED AND RESTATED CERTIFICATE OF
FORMATION
OF
[NAUTICUS ROBOTICS INC.]

[Nauticus Robotics Inc.] (the "Corporation"), pursuant to the provisions of Section 3.059 of the Texas Business Organizations Code (the "TBOC"), hereby adopts this [•] Amended and Restated Certificate of Formation which accurately copies and makes new amendments to the [Amended and Restated] Certificate of Formation of the Company (the "Certificate of Formation") and all amendments thereto that are in effect to date and as further amended by such [•] Amended and Restated Certificate of Formation.

ARTICLE ONE
DELETED ARTICLES

Article [XII] through Article [XIII], inclusive, to the Company's Certificate of Formation are hereby deleted in their entirety.

ARTICLE TWO
AMENDED AND RESTATED ARTICLES

Article [I] through Article [XI], inclusive, to the Company's Certificate of Formation are hereby amended and restated in their entirety. The full text of each amended and restated Article [I] through Article [XI], inclusive, is contained in the [•] Amended and Restated Certificate of Formation attached hereto as Exhibit A.

ARTICLE THREE
STATEMENT OF APPROVAL

Each new amendment has been made in accordance with the provisions of the TBOC. The amendments to the Certificate of Formation and the [•] Amended and Restated Certificate of Formation have been approved in the manner required by the TBOC and the governing documents of the Corporation.

ARTICLE FOUR
REQUIRED STATEMENTS

The [•] Amended and Restated Certificate of Formation, which is attached hereto as Exhibit A, accurately states the text of the Certificate of Formation being restated and each amendment to the Certificate of Formation being restated that is in effect, and as further amended by the [•] Amended and Restated Certificate of Formation. The attached [•] Amended and Restated Certificate of Formation does not contain any other changes in the Certificate of Formation being restated except for the information permitted to be omitted by the provisions of the TBOC applicable to the Company.

ARTICLE FIVE
EFFECTIVENESS OF FILING

This document becomes effective when filed by the Secretary of State of the State of Texas.

[Signature page follows]

1 NTD: The numbering will depend on how the name change is processed (e.g. through an amendment and restatement or an amendment to the latest A&R charter).

[Table of Contents](#)

IN WITNESS WHEREOF, this [•] Amended and Restated Certificate of Formation has been executed by a duly authorized officer of [Nauticus Robotics Inc.], on this ____ day of _____, 2022.

[NAUTICUS ROBOTICS INC.]
By: _____
Name: _____
Title: _____

[Signature Page to the [•] Amended and Restated Certificate of Formation — [Nauticus Robotics Inc.]

**[•] AMENDED AND RESTATED CERTIFICATE OF FORMATION OF
[NAUTICUS ROBOTICS INC.]**

The Corporation (defined below), under the Texas Business Organization Code, as amended (the “TBOC”), hereby adopts the following [•] Amended and Restated Certificate of Formation:

**ARTICLE I
NAME**

The name of the corporation is [Nauticus Robotics Inc.] (the “Corporation”).

**ARTICLE II
REGISTERED OFFICE AND AGENT**

The address of the Corporation’s registered office in the State of Texas is [____], and the name of the registered agent at such address is [_____]²

**ARTICLE III
PURPOSE**

The purpose of the Corporation is to engage in any lawful act or activity for which a corporation may be organized under the TBOC.

**ARTICLE IV
DURATION**

The Corporation shall have perpetual existence.

**ARTICLE V
CAPITAL STOCK**

A. The aggregate number of shares of capital stock which the Corporation shall have authority to issue is 100 shares of common stock with a par value of \$0.001 per share.

B. Except as otherwise required by the TBOC, all shares of common stock shall be identical in all respects and shall entitle the holders thereof to the same rights and privileges, subject to the same qualifications, limitations and restrictions.

**ARTICLE VI
INDEMNIFICATION**

C. To the fullest extent permitted by the TBOC as the same exists or as may hereafter be amended, a director of the Corporation shall not be personally liable to the Corporation or its stockholders for monetary damages for breach of fiduciary duty as a director; provided, however, that nothing contained in this Article VI shall eliminate or limit the liability of a director (i) for a breach of the director’s duty of loyalty, if any, to the Corporation or its shareholders, (ii) an act or omission not committed in good faith that constitutes a breach of duty of the director to the Corporation, (iii) an act or omission not committed in good faith that constitutes a breach of a duty owed by the director to the Corporation or its shareholders, (iv) willful or intentional misconduct in the performance of the director’s duty to the Corporation, or (v) a transaction from which the director received an improper benefit, regardless of whether the benefit resulted from an action taken within the scope of the director’s duties. No repeal or modification of this Article VI shall apply to or have any adverse effect on any right or protection of, or any limitation of the liability of, a director of the Corporation existing at the time of such repeal or modification with respect to acts or omissions occurring prior to such repeal or modification.

D. The Corporation may indemnify, and advance expenses to, to the fullest extent permitted by law, any person who was or is a party to or is threatened to be made a party to any threatened, pending or completed action, suit or proceeding, whether civil, criminal, administrative or investigative by reason of the fact that the person is or was a director, officer, employee or agent of the Corporation, or is or was serving at the request of the Corporation as a director, officer, employee or agent of another corporation, partnership, joint venture, trust or other enterprise.

2 NTD: To discuss using CSC or other service provider.

**ARTICLE VII
CORPORATE OPPORTUNITIES**

To the fullest extent permitted by law, the doctrine of corporate opportunity and any analogous doctrine (any such potential opportunity, a “Corporate Opportunity”) shall not apply to any stockholder, director, officer or any other person or entity (including, with respect to any of the foregoing that are entities, any affiliates and their respective directors, officers, partners, members and associated entities) in each case who is not a full-time employee of the Corporation or any of its subsidiaries (each, an “Exempted Person”). The Corporation renounces any interest or expectancy of the Corporation in, or in being offered an opportunity to participate in, business opportunities (including Corporate Opportunities) that are from time to time presented to any Exempted Person. Each Exempted Person who acquires knowledge of a potential circumstance, transaction, agreement, arrangement or other matter that may be a Corporate Opportunity shall not (a) have any duty to communicate or offer such opportunity to the Corporation and (b) shall not be liable to the Corporation, its subsidiaries or to the stockholders of the Corporation because such Exempted Person pursues or acquires for, or directs such opportunity to, itself or another Person or does not communicate such opportunity or information to the Corporation. To the fullest extent permitted by law, no potential transaction or business opportunity may be deemed to be a potential corporate opportunity of the Corporation or its subsidiaries unless (a) the Corporation and its subsidiaries would be permitted to undertake such transaction or opportunity in accordance with this [•] Amended and Restated Certificate of Incorporation, (b) the Corporation and its subsidiaries at such time have sufficient financial resources to undertake such transaction or opportunity and (c) such transaction or opportunity would be in the same line of business in which the Corporation and its subsidiaries are then engaged or a line of business that is reasonably related to, or a reasonable extension of, such line of business. No amendment or repeal of this Article VII shall apply to or have any effect on the liability or alleged liability of any Exempted Person for or with respect to any activities or opportunities of which such Exempted Person becomes aware prior to such amendment or repeal. This Article VII shall not limit any protections or defenses available to, or indemnification or advancement rights of, any director or officer of the Corporation under this Eighth Amended and Restated Certificate of Incorporation, the bylaws of the Corporation (the “Bylaws”) or applicable law.

**ARTICLE VIII
AMENDMENT**

The Corporation reserves the right to amend, alter, change or repeal any provision contained in this [•] Amended and Restated Certificate of Formation, in the manner now or hereafter prescribed by statute, and all rights conferred on stockholders herein are granted subject to this reservation.

**ARTICLE XI
BOARD OF DIRECTORS**

The number of directors which shall constitute the whole board of directors (the “Board of Directors”) of the Corporation shall be fixed from time to time by, or in the manner provided in, the Bylaws of the Corporation or in an amendment thereof duly adopted by the Board of Directors of the Corporation or by the stockholders of the Corporation.

**ARTICLE X
MEETINGS AND RECORDS**

Meetings of stockholders of the Corporation may be held within or without the State of Texas, as the Bylaws of the Corporation may provide. The books of the corporation may be kept (subject to any provision contained in the TBOC) outside the State of Texas at such place or places as may be designated from time to time by the Board of Directors of the Corporation or in the Bylaws of the Corporation.

**ARTICLE XI
BYLAWS**

Except as otherwise provided in this [•] Amended and Restated Certificate of Incorporation, in furtherance and not in limitation of the powers conferred by statute, the Board of Directors of the Corporation is expressly authorized to make, repeal, alter, amend and rescind any or all of the Bylaws of the Corporation.

EXHIBIT F

SHARE ESCROW AGREEMENT

THIS ESCROW AGREEMENT (“Agreement”) is made and entered into as of [], by and between [], a Corporation; and, joint representatives (“company stockholder representatives”) and Continental Stock Transfer & Trust Company, a New York corporation (“Escrow Agent”).

NOW THEREFORE, in consideration of the foregoing and of the mutual covenants hereinafter set forth, the parties hereto agree as follows:

1. Appointment

(a) [] hereby appoints the Escrow Agent as its escrow agent for the purposes set forth herein, and the Escrow Agent hereby accepts such appointment under the terms and conditions set forth herein.

(b) All capitalized terms with respect to the Escrow Agent shall be defined herein. The Escrow Agent shall act only in accordance with the terms and conditions contained in this Agreement and shall have no duties or obligations with respect to the Underlying Agreement.

2. Escrow Shares

(a) [] agrees to deposit with the Escrow Agent Common shares of [] (“Escrow Shares”) on the date hereof. The Escrow Agent shall hold the Escrow Shares as a book-entry position registered in the name of “Continental Stock Transfer & Trust as Escrow Agent for the benefit of [].

(b) During the term of this Agreement, [] shall not have, or have, the right to exercise any voting rights with respect to any of the Escrow Shares. With respect to any matter for which the Escrow Shares are permitted to vote, the Escrow Agent shall vote, or cause to be voted the Escrow Shares in the same proportion that the number of common shares of owned by all other shareholders of are voted. In the absence of notice as to the proportion that the number of common shares of owned by all other shareholders of are voted, the Escrow Agent shall not vote any of the shares comprising the Escrow Shares.

(c) Any dividends paid with respect to the Escrow Shares shall be deemed part of the Escrow and be delivered to the Escrow Agent to be held in a bank account and be deposited in a non-interest bearing account to be maintained by the Escrow Agent in the name of the Escrow Agent.

(d) In the event of any stock split, reverse stock split, stock dividend, recapitalization, reorganization, merger, consolidation, combination, exchange of shares, liquidation, spin-off or other similar change in capitalization or event, or any distribution to holders of the common stock of, other than a regular cash dividend, the Escrow Shares shall be appropriately adjusted on a pro rata basis and consistent with the terms of the Agreements.

3. Disposition and Termination

(a) The Escrow Agent shall administer the Escrow Shares in accordance with written instructions provided by [] to the Escrow Agent to release the Escrow Shares, or any portion thereof, as set forth in such instruction. The Escrow Agent shall make distributions of the Escrow Shares only in accordance with a written instruction.

(b) Upon the delivery of all the Escrow Shares by the Escrow Agent in accordance with the terms of this Agreement and instructions, this Agreement shall terminate, subject to the provisions of Section 6.

4. Escrow Agent

(a) The Escrow Agent shall have only those duties as are specifically and expressly provided herein, which shall be deemed purely ministerial in nature, and no other duties shall be implied. The Escrow Agent shall neither be responsible for, nor chargeable with, knowledge of, nor have any requirements to comply with, the terms and conditions of any other agreement, instrument or document between and any other person or entity, in connection herewith, if any, including without limitation the Underlying Agreement or nor shall the Escrow Agent be required to determine if any person or entity has complied with any such agreements, nor shall any additional obligation of the Escrow Agent be inferred from the terms of such agreements, even though reference thereto may be made in this Agreement.

[Table of Contents](#)

(b) In the event of any conflict between the terms and provisions of this Agreement, those of the Underlying Agreement, any schedule or exhibit attached to this Agreement, or any other agreement between and or any other person or entity, the terms and conditions of this Agreement shall control.

(c) The Escrow Agent may rely upon and shall not be liable for acting or refraining from acting upon any written notice, document, instruction or request furnished to it hereunder and believed by it to be genuine and to have been signed or presented by the without inquiry and without requiring substantiating evidence of any kind. The Escrow Agent shall not be liable to any beneficiary or other person for refraining from acting upon any instruction setting forth, claiming, containing, objecting to, or related to the transfer or distribution of the Escrow Shares, or any portion thereof, unless such instruction shall have been delivered to the Escrow Agent in accordance with Section 9 below and the Escrow Agent has been able to satisfy any applicable security procedures as may be required hereunder and as set forth in Section 10. The Escrow Agent shall be under no duty to inquire into or investigate the validity, accuracy or content of any such document, notice, instruction or request. The Escrow Agent shall have no duty to solicit any payments which may be due nor shall the Escrow Agent have any duty or obligation to confirm or verify the accuracy or correctness of any amounts deposited with it hereunder.

(d) The Escrow Agent shall not be liable for any action taken, suffered or omitted to be taken by it in good faith except to the extent that a final adjudication of a court of competent jurisdiction determines that the Escrow Agent's gross negligence or willful misconduct was the primary cause of any loss to either or the beneficiary. The Escrow Agent may execute any of its powers and perform any of its duties hereunder directly or through affiliates or agents.

(e) The Escrow Agent may consult with counsel, accountants and other skilled persons to be selected and retained by it. The Escrow Agent shall not be liable for any action taken, suffered or omitted to be taken by it in accordance with, or in reliance upon, the advice or opinion of any such counsel, accountants or other skilled persons except to the extent that a final adjudication of a court of competent jurisdiction determines that the Escrow Agent's gross negligence or willful misconduct was the primary cause of any loss to either or the beneficiary. In the event that the Escrow Agent shall be uncertain or believe there is some ambiguity as to its duties or rights hereunder or shall receive instructions, claims or demands from hereto which, in its opinion, conflict with any of the provisions of this Agreement, it shall be entitled to refrain from taking any action and its sole obligation shall be to keep safely all the property held in escrow until it shall be given a direction in writing which eliminates such ambiguity or uncertainty to the satisfaction of the Escrow Agent or by a final and non-appealable order or judgement of a court of competent jurisdiction agrees to pursue any redress or recourse in connection with any dispute without making the Escrow Agent a party to the same.

5. Succession

(a) The Escrow Agent may resign and be discharged from its duties or obligations hereunder by giving thirty (30) days' advance notice in writing of such resignation to specifying a date when such resignation a date when such resignation shall take effect, provided that such resignation shall not take effect until a successor Escrow Agent has been appointed in accordance with this Section 5. If [] has failed to appoint a successor Escrow Agent prior to the expiration of thirty (30) days following receipt of the notice of resignation, the Escrow Agent may petition any court of competent jurisdiction for the appointment of a successor Escrow Agent or for other appropriate relief, and any such resulting appointment shall be binding upon all of the parties hereto. The Escrow Agent's sole responsibility after such thirty (30) day notice period expires shall be to hold the Escrow Shares (without any obligation to reinvest the same) and to deliver the same to a designated substitute Escrow Agent, if any, or in accordance with the directions of a final order or judgement of a court of competent jurisdiction, at which time of delivery the Escrow Agent's obligations hereunder shall ease and terminate, subject to the provisions of Section 7 below. In accordance with Section 7 below, the Escrow Agent shall have the right to withhold, as security, an amount of shares equal to any dollar amount due and owing to the Escrow Agent, plus any costs and expenses the Escrow Agent shall reasonably believe may be incurred by the Escrow Agent in connection with the termination of this Agreement.

(b) Any entity into which the Escrow Agent may be merged or converted or with which it may be consolidated, or any entity to which all or substantially all the escrow business may be transferred, shall be the Escrow Agent under this Agreement without further act.

6. Compensation and Reimbursement

The Escrow Agent shall be entitled to compensation for its services under this Agreement as Escrow Agent and for reimbursement for its reasonable out-of-pocket costs and expenses, in the amounts and payable as set forth on Schedule 2. The Escrow Agent shall also be entitled to payments of any amounts to which the Escrow Agent is entitled under the indemnification provisions contained herein as set forth in Section 7. The obligations of [] set forth in this Section 6 shall survive the resignation, replacement or removal of the Escrow Agent or the termination of this Agreement.

7. Indemnity

(a) The Escrow Agent shall be indemnified and held harmless by from and against any expenses, including counsel fees and disbursements, or loss suffered by the Escrow Agent in connection with any action, suit or other proceeding involving any claim which in any way, directly or indirectly, arises out of or relates to this Agreement, the services of the Escrow Agent hereunder, other than expenses or losses arising from the gross negligence or willful misconduct of the Escrow Agent. Promptly after the receipt by the Escrow Agent of notice of any demand or claim or the commencement of any action, suit or proceeding, the Escrow Agent shall notify the other parties hereto in writing. In the event of the receipt of such notice, the Escrow Agent, in its sole discretion, may commence an action in the Nature of Interpleader in any state of federal court located in New York County, State of New York.

(b) The Escrow Agent shall not be liable for any action taken or omitted by it in good faith and in the exercise of its own best judgement, and may rely conclusively and shall be protected in acting upon any order, notice, demand, certificate, opinion or advice of counsel (including counsel chosen by the Escrow Agent), statement, instrument, report or other paper or document (not only as to its due execution and the validity and effectiveness of its provisions, but also as to the truth and acceptability of any information therein contained) which is believed by the Escrow Agent to be genuine and to be signed or presented by the proper person or persons. The Escrow Agent shall not be bound by any notice or demand, or any waiver, modification, termination or rescission of this Agreement unless evidenced by a writing delivered to the Escrow Agent are affected, unless it shall have given its prior written consent thereto.

(c) The Escrow Agent shall not be liable for any action taken by it in good faith and believed by it to be authorized or within the rights or powers conferred upon it by this Agreement, and may consult with counsel of its own choice and shall have full and complete authorization and indemnification, for any action take or suffered by it hereunder in good faith and in accordance with the opinion of such counsel.

(d) This Section 7 shall survive termination of this Agreement or the resignation, replacement or removal of the Escrow Agent for any reason.

8. Patriot Act Disclosure/Taxpayer Identification Numbers/Tax Reporting

(a) Patriot Act Disclosure. Section 326 of the Uniting and Strengthening America by Providing Appropriate Tools Required to Intercept and Obstruct Terrorism Act of 2001 (“USA PATRIOT Act”) requires the Escrow Agent to implement reasonable procedures to verify the identity of any person that opens a new account with it. Accordingly, [] acknowledges that Section 326 of the USA PATRIOT Act and the Escrow Agents’ identity verification procedures require the Escrow Agent to obtain information which may be used to confirm identity including without limitation name, address and organizational documents (“identifying information”). agrees to provide the Escrow Agent with and consent to the Escrow Agent obtaining from third parties any such identifying information required as a condition of opening an account with or using any service provided by the Escrow Agent.

(b) Such underlying transaction does not constitute an installment sale requiring any tax reporting or withholding of imputed interest or original issue discount to the IRS or other taxing authority.

9. Notices

All communications hereunder shall be in writing and except for communications from [] setting forth, claiming, containing, objecting to, or in any way related to the full or partial transfer or distribution of the Escrow Shares, including but not limited to transfer instructions (all of which shall be specifically governed by Section 10 below), all notices and communications hereunder shall be deemed to have been duly given and made if in writing and if (i) served by personal delivery upon the party for whom it is intended, (ii) delivered by registered or certified mail, return receipt requested, or by Federal Express or similar overnight courier, or (iii) sent by facsimile or email, electronically or otherwise, to the party at the address set forth below, or such other address as may be designated in writing hereafter, in the same manner, by such party:

If to the Escrow Agent:

Continental Stock Transfer and Trust
One State Street — 30th Floor
New York, New York 10004
Facsimile No: (212) 616-7615
Attention:

Notwithstanding the above, in the case of communications delivered to the Escrow Agent, such communications shall be deemed to have been given on the date received by an officer of the Escrow Agent or any employee of the Escrow Agent who reports directly to any such officer at the above-referenced office. In the event that the Escrow Agent, in its sole discretion, shall determine that an emergency exists, the Escrow Agent may use such other means of communication as the Escrow Agent deems appropriate. For purposes of this Agreement, "Business Day" shall mean any day other than a Saturday, Sunday or any other day on which the Escrow Agent located at the notice address set forth above is authorized or required by law or executive order to remain closed.

10. Security Procedures

Notwithstanding anything to the contrary as set forth in Section 9, any instructions setting forth, claiming, containing, objecting to, or in any way related to the transfer distribution, including but not limited to any transfer instructions that may otherwise be set forth in a written instruction permitted pursuant to Section 3 of this Agreement, may be given to the Escrow Agent only by confirmed facsimile or other electronic transmission (including e-mail) and no instruction for or related to the transfer or distribution of the Escrow Shares, or any portion thereof, shall be deemed delivered and effective unless the Escrow Agent actually shall have received such instruction by facsimile or other electronic transmission (including e-mail) at the number or e-mail address provided to by the Escrow Agent in accordance with Section 9 and as further evidenced by a confirmed transmittal to that number.

(a) In the event transfer instructions are so received by the Escrow Agent by facsimile or other electronic transmission (including e-mail), the Escrow Agent is authorized to seek confirmation of such instructions by telephone call-back to the person or persons designated on Schedule 1 hereto, and the Escrow Agent may rely upon the confirmation of anyone purporting to be the person or persons so designated. The persons and telephone numbers for call-backs may be changed only in writing actually received and acknowledged by the Escrow Agent. If the Escrow Agent is unable to contact any of the authorized representatives identified in Schedule 1, the Escrow Agent is hereby authorized both to receive written instructions from and seek confirmation of such instructions by officers of (collectively, the "Senior Officers"), as the case may be, which shall include the titles of Chief Executive Officer, General Counsel, Chief Financial Officer, President of Executive Vice President, as the Escrow Agent may select. Such Senior Officer shall deliver to the Escrow Agent a fully executed incumbency certificate, and the Escrow Agent may rely upon the confirmation of anyone purporting to be any such officer.

(b) [] acknowledges that the Escrow Agent is authorized to deliver the Escrow Shares to the custodian account of recipient designated by [] in writing.

11. Compliance with Court Officers

In the event that any escrow property shall be attached, garnished or levied upon by any court order, or the delivery thereof shall be stayed or enjoined by an order of a court, or any order, judgement or decree shall be made or entered by any court order affecting the property deposited under this Agreement, the Escrow Agent is hereby expressly authorized, in its sole discretion, to obey and comply with all writs, orders or decrees so entered or whether with or without jurisdiction, and in the event that the Escrow Agent reasonably obeys or complies with any such writ, order or decree it shall not be liable to any of the parties hereto or to any other person, entity, firm or corporation, by reason of such compliance notwithstanding such writ, order or decree by subsequently reversed, modified, annulled, set aside or vacated.

12. Miscellaneous

Except for changes to transfer instructions as provided in Section 10, the provisions of this Agreement may be waived, altered, amended or supplemented, in whole or in part, only by a writing signed by the Escrow Agent and. Neither this Agreement nor any right or interest hereunder may be assigned in whole or in part by the Escrow Agent or except as provided in Section 5, without the prior consent of the Escrow Agent and. This Agreement shall be governed by and construed under the laws of the State of New York. Each of [] and the Escrow Agent irrevocably waives any objection on the grounds of venue, forum non-convenience or any similar grounds and irrevocably consents to service of process by mail or in any other manner permitted by applicable law and consents to the jurisdiction of any court of the State of New York or United States federal court, in each case, sitting in New York County, New York. To the extent that in any jurisdiction any party may now or hereafter be entitled to claim for itself or its assets, immunity from suit, execution attachment (before or after judgement), or other legal process, such party shall not claim, and it hereby irrevocably waives, such immunity. The parties further hereby waive any right to a trial by jury with respect to any lawsuit or judicial proceedings arising or relating to this Agreement. No party to this Agreement is liable to any other party for losses due to, or if it is unable to perform its obligations under the terms of this Agreement because of, acts of God, fire, war, terrorism, floods, strikes, electrical outages, equipment or transmission failure, or other causes reasonably beyond its control.

This Agreement may be executed in one or more counterparts, each of which shall be deemed an original, but all of which together shall constitute one and the same instrument. All signatures of the parties to this Agreement may be transmitted by facsimile or other electronic transmission (including e-mail), and such facsimile or other electronic transmission (including e-mail) will, for all purposes, be deemed to be the original signature of such party whose signature it reproduces, and will be binding upon such party. If any provision of this Agreement is determined to be prohibited or unenforceable by reason of any applicable law of a jurisdiction, then such provision shall, as to such jurisdiction, be ineffective to the extent of such prohibition or unenforceability without invalidating the remaining provisions thereof, and any such prohibition or unenforceability in such jurisdiction shall not invalidate or render unenforceable such provisions in any other jurisdiction. A person who is not a party to this Agreement shall have no right to enforce any term of this Agreement. The parties represent, warrant and covenant that each document, notice, instruction or request provided by such party to the other party shall comply with applicable laws and regulations. Where, however, the conflicting provisions of any such applicable law may be waived, they are hereby irrevocably waived by the parties hereto to the fullest extent permitted by law, to the end that this Agreement shall be enforced as written. Except as expressly provided in Section 7 above, nothing in this Agreement, whether express or implied, shall be construed to give to any person or entity other than the Escrow Agent and any legal or equitable right, remedy, interest or claim under or in respect of this Agreement or the Escrow Shares escrowed hereunder.

[REMAINDER OF THIS PAGE INTENTIONALLY LEFT BLANK]

[Table of Contents](#)

IN WITNESS WHEREOF, the parties hereto have executed this Agreement as of the date set forth above.

By: _____
Name:
Title:
Telephone:

ESCROW AGENT: CONTINENTAL STOCK TRANSFER AND TRUST
By: _____
Name:
Title:

[Signature Page to Escrow Agreement]

Schedule 1

Telephone Number(s) and authorized signature(s) for Person(s) Designated to give Escrow Asset Transfer Instructions

<u>Name:</u>
<u>Telephone:</u>
<u>Number:</u>
<u>Signature:</u>

EXHIBIT G

FORM OF DIRECTOR NOMINATION AGREEMENT

THIS DIRECTOR NOMINATION AGREEMENT (this “*Agreement*”) is made and entered into as of [•], 2021 (the “*Effective Time*”), by and among Nauticus Robotics Inc., a Delaware corporation (f/k/a CleanTech Acquisition Corp.) (the “*Company*”), CleanTech Sponsor I LLC, a Delaware limited liability company (“*CleanTech Sponsor*”) and CleanTech Investments, LLC (“*CleanTech Investments*” and together with CleanTech Sponsor, the “*Sponsors*”). Capitalized terms used but not otherwise defined in this Agreement have the respective meanings given to them in the Merger Agreement (as defined below).

WHEREAS, the Company and certain of its affiliates have consummated the business combination and the other transactions (collectively, the “*Transactions*”) contemplated by the Agreement and Plan of Merger, dated as of [•], 2021, by and among the CleanTech Acquisition Corp., a Delaware corporation, CleanTech Merger Sub, Inc., a Texas corporation, Nauticus Robotics (Texas), Inc., a Texas corporation (f/k/a Nauticus Robotics, Inc. and prior to December [], 2021, Houston Mechatronics, Inc.), and Nicolaus Radford solely in his capacity as the Stockholder Representative thereunder (the “*Merger Agreement*”);

WHEREAS, in their capacities as the co-sponsors of the special purpose acquisition company that was the predecessor to the Company, the Sponsors desire that, after giving effect to the Transactions, it will continue to have representation on the Board so as to continue to create value for its direct and indirect equityholders (collectively with the Sponsors, the “*Sponsor Parties*”) and for the other direct and indirect equityholders of the Company; and

WHEREAS, in furtherance of the foregoing, the Sponsors desire to have certain director nomination rights with respect to the Company, and the Company desires to provide the Sponsors, on behalf of the Sponsor Parties, with such rights, in each case, on the terms and conditions set forth herein.

NOW, THEREFORE, in consideration of the mutual covenants contained herein and other good and valuable consideration, the receipt and sufficient of which are hereby acknowledged, each of the parties to this Agreement agrees as follows:

ARTICLE I

NOMINATION RIGHT

Section 1.1 Board Nomination Right.

(a) From the Effective Time until the termination of this Agreement in accordance with Section 2.1, at every meeting of the board of directors of the Company (the “*Board*”), or a committee thereof, or action by written consent, at or by which directors of the Company are appointed by the Board or are nominated to stand for election and elected by stockholders of the Company, the Sponsors shall have the right to appoint or nominate for election to the Board, as applicable, one (1) individual, to serve as an independent director (in accordance with NASDAQ rules) of the Company (the individual appointed or nominated by the Sponsors for election to the Board pursuant to this Section 1.1(a), a “*Nominee*”); provided, that such representative shall be reasonably acceptable to the Founder. At the Effective Time, unless otherwise designated by the Sponsors, the Nominee shall be [•], who the Founder has confirmed as being reasonably acceptable to the Founder.

(b) The Company shall take all necessary actions within its control, including but not limited to calling a meeting of the Board or executing an action by unanimous written consent of the Board, such that, as of the Effective Time, the Nominee shall either be elected by the Company’s stockholders at the meeting held to approve the Transactions or appointed to the Board as of the Effective Time as a director of the Company.

(c) From and after the Effective Time, the Company shall take all actions necessary (including, without limitation, calling special meetings of the Board and the stockholders of the Company and recommending, supporting and soliciting proxies) to ensure that: (i) the Nominee is included in the Board’s slate of nominees to the stockholders of the Company for the election of directors of the Company and recommended by the Board at any meeting of stockholders called for the purpose of electing directors of the Company; and (ii) the Nominee, if up for election, is included in the proxy statement prepared by management of the Company in connection with the

[Table of Contents](#)

Company's solicitation of proxies or consents in favor of the foregoing for every meeting of the stockholders of the Company called with respect to the election of members of the Board, and at every adjournment or postponement thereof, and on every action or approval by written resolution of the stockholders of the Company or the Board with respect to the election of directors of the Company.

(d) If the Nominee ceases to serve for any reason, the Sponsors shall be entitled to designate or nominate such person's successor in accordance with this Agreement and the Board shall promptly fill the vacancy with such successor Nominee; provided, that such successor shall be reasonably acceptable to the Founder.

(e) [intentionally omitted]

(f) The Company shall indemnify the Nominee on the same basis as all other members of the Board and pursuant to an indemnity agreement with terms that are no less favorable to the Nominee than the indemnity agreements entered into between the Company and its other non-employee directors.

(g) The Nominee shall be entitled to compensation (including equity awards) that is consistent with the compensation received by other non-employee directors of the Company. In addition, the Company shall pay the reasonable, documented, out-of-pocket expenses incurred by the Nominee in connection with his or her services provided to or on behalf of the Company and its Subsidiaries, including attending Board and committee meetings or events attended on behalf of the Company or at the Company's request.

(h) Notwithstanding the provisions of this Section 1.1, the Sponsors shall not be entitled to designate a Person as a nominee to the Board upon a written determination by the Board or relevant committee thereof that the Person would not be qualified under any applicable law, rule or regulation to serve as a director of the Company. In such an event, the Sponsors shall be entitled to select a Person as a replacement Nominee and the Company shall take all necessary actions within its control to cause that Person to be nominated as a Nominee, including, without limitation, taking such necessary actions to cause that Person to be nominated as a Nominee at the same meeting (or, if permitted, pursuant to the same action by written consent of the stockholders) as the initial Person was to be nominated; provided, that any such replacement Nominee shall be reasonably acceptable to the Founder.

ARTICLE II

MISCELLANEOUS

Section 2.1 Termination. This Agreement shall terminate automatically and become void and of no further force or effect, without any notice or other action by any Person, as of the fifteen (15)-month anniversary of the Effective Time.

Section 2.2 Notices. All notices, requests and other communications to the Company hereunder shall be in writing (including electronic transmission) and shall be given in accordance with the provisions of the Merger Agreement. All notices, requests and other communications to the Sponsors hereunder shall be in writing (including electronic transmission) to the following address and shall be given in accordance with the provisions of the Merger Agreement:

If to Sponsors, to:

CleanTech Sponsor I LLC
207 W. 25th Street, 9th Floor
New York, NY 10001
Attention: Eli Spiro
E-mail: espiro@axxcesscapital.com

CleanTech Investments, LLC
207 W. 25th Street, 9th Floor
New York, NY 10001
Attention: Jonas Grossman
Email: jgrossman@chardan.com

with a copy to (which shall not constitute notice):

Loeb & Loeb LLP
345 Park Avenue
New York, NY 10154
Attn: Giovanni Caruso
Email: gcaruso@loeb.com

Section 2.3 Severability. If any term or other provision of this Agreement is invalid, illegal or incapable of being enforced by any rule of law or public policy, all other terms, conditions and provisions of this Agreement shall nevertheless remain in full force and effect so long as the economic or legal substance of the transactions contemplated by this Agreement is not affected in any manner materially adverse to any party hereto. Upon such determination that any term or other provision is invalid, illegal or incapable of being enforced, the parties hereto shall negotiate in good faith to modify this Agreement so as to effect the original intent of the parties hereto as closely as possible in a mutually acceptable manner in order that the Transactions contemplated by this Agreement be consummated as originally contemplated to the fullest extent possible.

Section 2.4 Binding Effect; Assignment. This Agreement and all of the provisions hereof shall be binding upon and shall inure to the benefit of the parties hereto and their respective successors and permitted assigns. Neither this Agreement nor any of the rights, interests or obligations hereunder shall be assigned, directly or indirectly, including by operation of law, by any party hereto without the prior written consent of the other party hereto, except notwithstanding any of the foregoing, the Sponsors may, in connection with a transfer of shares of the Company's common stock to one of their Affiliates, assign its rights and obligations hereunder to such Affiliate transferee, in which case the prior consent of the Company shall not be required.

Section 2.5 No Third Party Beneficiaries. This Agreement is exclusively for the benefit of the parties hereto, and their respective successors and permitted assigns, and this Agreement shall not be deemed to confer upon or give to any other third party any remedy, claim, liability, reimbursement, cause of action or other right by virtue of any applicable law in any jurisdiction to enforce any of the terms to this Agreement.

Section 2.6 Entire Agreement. This Agreement constitutes the entire agreement among the parties with respect to the subject matter of this Agreement and supersedes all other prior agreements and understandings, both written and oral, between the parties with respect to the subject matter of this Agreement. Each party hereto acknowledges and agrees that, in entering into this Agreement, such party has not relied on any promises or assurances, written or oral, that are not reflected in this Agreement.

Section 2.7 Governing Law. This Agreement, and all claims or causes of action based upon, arising out of, or related to this Agreement or the transactions contemplated hereby, shall be governed by, and construed in accordance with, the Laws of the State of Delaware, without giving effect to principles or rules of conflict of Laws to the extent such principles or rules would require or permit the application of Laws of another jurisdiction.

Section 2.8 Jurisdiction; WAIVER OF TRIAL BY JURY. Any Action based upon, arising out of or related to this Agreement or the transactions contemplated hereby may be brought in federal and state courts located in the State of Delaware, and each of the parties irrevocably submits to the exclusive jurisdiction of each such court in any such Action, waives any objection it may now or hereafter have to personal jurisdiction, venue or to convenience of forum, agrees that all claims in respect of the Action shall be heard and determined only in any such court, and agrees not to bring any Action arising out of or relating to this Agreement or the transactions contemplated hereby in any other court. Nothing herein contained shall be deemed to affect the right of any party hereto to serve process in any manner permitted by Law or to commence legal proceedings or otherwise proceed against the other party hereto in any other jurisdiction, in each case, to enforce judgments obtained in any Action brought pursuant to this Section 2.8. EACH OF THE PARTIES HERETO HEREBY IRREVOCABLY WAIVES ANY AND ALL RIGHT TO TRIAL BY JURY IN ANY ACTION BASED UPON, ARISING OUT OF OR RELATED TO THIS AGREEMENT OR THE SUBJECT MATTER HEREOF.

Section 2.9 Specific Performance. The parties hereto acknowledge that the rights of each party hereto to consummate the transactions contemplated hereby are unique and recognize and affirm that in the event of a breach of this Agreement by any party hereto, money damages may be inadequate and such non-breaching party may have no adequate remedy at law. Accordingly, the parties hereto agree that such non-breaching party shall have the right to

[Table of Contents](#)

enforce its rights and the other party's obligations hereunder by an action or actions for specific performance and/or injunctive relief (without posting of bond or other security), including any order, injunction or decree sought by such non-breaching party to cause the other party to perform its/their respective agreements and covenants contained in this Agreement and to cure breaches of this Agreement, without the necessity of proving actual harm and/or damages or posting a bond or other security therefore. Each party hereto further agrees that the only permitted objection that it may raise in response to any action for any such equitable relief is that it contests the existence of a breach or threatened breach of this Agreement.

Section 2.10 Counterparts. This Agreement may be executed in counterparts, each of which shall be deemed to be an original, but all of which taken together shall constitute one and the same agreement. Delivery of an executed counterpart of a signature page to this Agreement by facsimile or e-mail shall be as effective as delivery of a manually executed counterpart of the Agreement.

Section 2.11 Amendment. This Agreement may be amended, modified or supplemented at any time only by the written consent of all of the parties hereto, and any amendment, modification or supplement so effected shall be binding on all of the parties.

Section 2.12 Rights Cumulative. Except as otherwise expressly limited by this Agreement, all rights and remedies of each of the parties hereto under this Agreement will be cumulative, and the exercise of one or more rights or remedies will not preclude the exercise of any other right or remedy available under this Agreement or law.

Section 2.13 Further Assurances. Each of the parties hereto shall execute and deliver such further instruments and do such further acts and things as may be required to carry out the intent and purpose of this Agreement.

Section 2.14 Enforcement. Each of the parties hereto covenants and agrees that the disinterested members of the Board have the right to enforce, waive or take any other action with respect to this Agreement on behalf of the Company.

Section 2.15 Headings. The headings herein are for convenience only, do not constitute a part of this Agreement and shall not be deemed to limit or affect any of the provisions hereof.

[Signature Page Follows.]

[Table of Contents](#)

IN WITNESS WHEREOF, the parties hereto have caused this Agreement to be duly executed as a deed as of the date first written above.

NAUTICUS ROBOTICS INC.
By: _____
Name: _____
Title: _____

CLEANTECH SPONSOR I LLC
By: _____
Name: _____
Title: _____

CLEANTECH INVESTMENTS, LLC
By: _____
Name: _____
Title: _____

[Signature Page to Director Nomination Agreement]

EXHIBIT H-1

FORM OF COMPANY STOCKHOLDER LOCK-UP AGREEMENT

THIS LOCK-UP AGREEMENT (this "Agreement") is dated as of December ___, 2021, by and between the undersigned (the "Holder") and Nauticus Robotics, Inc., a Delaware company, f/k/a CleanTech Acquisition Corp. Capitalized terms used and not otherwise defined herein shall have the meanings given such terms in the Merger Agreement (as defined below).

BACKGROUND

A. Nauticus Robotics, Inc., a Delaware company, f/k/a CleanTech Acquisition Corp. (the "Acquiror"), CleanTech Merger Sub Inc., a Texas company and wholly-owned subsidiary of Acquiror (the "Merger Sub"), and Houston Mechatronics, Inc., a Texas corporation (the "Company"), entered into an Agreement and Plan of Merger dated as of December ___, 2021 (the "Merger Agreement").

B. Pursuant to the Merger Agreement, the Acquiror will become the 100% stockholder of the Company (the "Transaction").

C. The Holder is the record and/or beneficial owner of equity securities of the Company, which will be exchanged for common stock of the Acquiror pursuant to the Merger Agreement.

D. As a condition of, and as a material inducement for the Company to enter into and consummate the transactions contemplated by the Merger Agreement, the Holder has agreed to execute and deliver this Agreement.

NOW, THEREFORE, for and in consideration of the mutual covenants and agreements set forth herein, and other good and valuable consideration, the receipt and sufficiency of which is hereby acknowledged, the parties, intending to be legally bound, agree as follows:

AGREEMENT

1. Lock-Up.

(a) During the Lock-up Period (as defined below), the Holder irrevocably agrees that it, he or she will not offer, sell, contract to sell, pledge or otherwise dispose of, directly or indirectly, any of the Lock-up Shares (as defined below), enter into a transaction that would have the same effect, or enter into any swap, hedge or other arrangement that transfers, in whole or in part, any of the economic consequences of ownership of such Lock-up Shares, whether any of these transactions are to be settled by delivery of any such Lock-up Shares, in cash or otherwise, publicly disclose the intention to make any offer, sale, pledge or disposition, or to enter into any transaction, swap, hedge or other arrangement, or engage in any Short Sales (as defined below) with respect to any security of Acquiror.

(b) In furtherance of the foregoing, Acquiror will (i) place an irrevocable stop order on all Lock-up Shares, including those which may be covered by a registration statement, and (ii) notify Acquiror's transfer agent in writing of the stop order and the restrictions on such Lock-up Shares under this Agreement and direct Acquiror's transfer agent not to process any attempts by the Holder to resell or transfer any Lock-up Shares, except in compliance with this Agreement.

(c) For purposes hereof, "Short Sales" include, without limitation, all "short sales" as defined in Rule 200 promulgated under Regulation SHO under the Securities Exchange Act of 1934, as amended (the "Exchange Act"), and all types of direct and indirect stock pledges, forward sale contracts, options, puts, calls, swaps and similar arrangements (including on a total return basis), and sales and other transactions through non-US broker dealers or foreign regulated brokers.

(d) For purpose of this Agreement, the "Lock-up Period" means the earlier of (x) the date this is 180 days following the Closing Date, (y) the date on which the VWAP of shares of PubCo's Common Stock equals or exceeds \$13.00 per share for twenty (20) of any thirty (30) consecutive trading days commencing after the Closing on Nasdaq and (z) the date specified in a written waiver of the provisions of this Agreement duly executed by the Sponsors and the Acquiror.

The restrictions set forth herein shall not apply to: (1) transfers or distributions to the Holder's current or former general or limited partners, managers or members, stockholders, other equity holders or direct or indirect affiliates (within the meaning of Rule 405 under the Securities Act of 1933, as amended) or to the estates of any of the foregoing; (2) transfers by bona fide gift to a member of the Holder's immediate family or to a trust, the beneficiary of which is the Holder or a member of the Holder's immediate family for estate planning purposes; (3) by virtue of the laws of descent and distribution upon death of the Holder; (4) pursuant to a qualified domestic relations order, in each case where such transferee agrees to be bound by the terms of this Agreement; (5) transfers or distributions of, or other transactions involving, securities other than the Lock-up Shares (including, without limitation, securities acquired in the PIPE or in open market transactions); or (6) in the case of Angela Berka (or Reginald Berka with respect to any community, marital or similar interest he may have in the following shares), the transfer of up to 1,000,000 shares of Lock-up Shares in a privately negotiated sale to another Company stockholder, who shall enter into a Lock-Up Agreement (or amend an existing Lock-Up Agreement) containing the same terms and conditions as this Agreement with respect to such shares, or the entry into any agreement with respect to such a sale entered into before, at or after the Effective Time.

In addition, the restrictions set forth herein shall not apply to any bona fide third-party tender offer, merger, consolidation, business combination, stock purchase or other similar transaction or series of related transactions after the Closing Date, if such transaction or transactions would result in a Change of Control; provided that in the event that such tender offer, merger, consolidation, business combination, stock purchase or transaction or series of related transactions is not completed, the Lock-up Shares shall remain subject to the restrictions set forth herein. A "Change of Control" means (whether by tender offer, merger, consolidation, asset sale or other similar transaction, whether in one or a series of related transactions): (a) the sale of all or substantially all of the consolidated assets of Acquiror and Acquiror subsidiaries to a third-party acquiror; (b) a sale resulting in no less than a majority of the voting power of the Acquiror being held by person that did not own a majority of the voting power prior to such sale; or (c) a merger, consolidation, recapitalization or reorganization of Acquiror with or into a third-party acquiror that results in the inability of the pre-transaction equity holders to designate or elect a majority of the Board of Directors (or its equivalent) of the resulting entity or its parent company. In the event that all or a portion of the securities subject to any other lock-up agreement entered into, or otherwise applicable, in connection with the Transaction are released early from the restrictions of such other such other lock-up agreement (whether by release, waiver, amendment, modification, termination or otherwise), the Lock-up Shares subject to this Agreement shall be released on a pro rata basis.

2. Representations and Warranties. Each of the parties hereto, by their respective execution and delivery of this Agreement, hereby represents and warrants to the others and to all third party beneficiaries of this Agreement that (a) such party has the full right, capacity and authority to enter into, deliver and perform its respective obligations under this Agreement, (b) this Agreement has been duly executed and delivered by such party and is the binding and enforceable obligation of such party, enforceable against such party in accordance with the terms of this Agreement, and (c) the execution, delivery and performance of such party's obligations under this Agreement will not conflict with or breach the terms of any other agreement, contract, commitment or understanding to which such party is a party or to which the assets or securities of such party are bound. The Acquiror represents and warrants that each 5% stockholder of the Company, and each holder of founder shares of the Acquiror, has entered into a lock-up agreement on substantially the same terms as the terms provided for in this Agreement.

3. Beneficial Ownership. The Holder hereby represents and warrants that it does not beneficially own, directly or through its nominees (as determined in accordance with Section 13(d) of the Exchange Act, and the rules and regulations promulgated thereunder), any shares of capital stock of Acquiror, or any economic interest in or derivative of such stock, other than those securities specified on the signature page hereto. For purposes of this Agreement, the shares of the Acquiror received by the Holder as merger consideration in the Transaction and beneficially owned by the Holder as specified on the signature hereto are collectively referred to as the "Lock-up Shares."

4. No Additional Fees/Payment. Other than the consideration specifically referenced herein, the parties hereto agree that no fee, payment or additional consideration in any form has been or will be paid to the Holder in connection with this Agreement.

[Table of Contents](#)

5. Notices . Any notices required or permitted to be sent hereunder shall be sent in writing, addressed as specified below, and shall be deemed given: (a) if by hand or recognized courier service, by 4:00 PM on a business day, addressee's day and time, on the date of delivery, and otherwise on the first business day after such delivery; (b) if by fax or email, on the date that transmission is confirmed electronically, if by 4:00PM on a business day, addressee's day and time, and otherwise on the first business day after the date of such confirmation; or (c) five days after mailing by certified or registered mail, return receipt requested. Notices shall be addressed to the respective parties as follows (excluding telephone numbers, which are for convenience only), or to such other address as a party shall specify to the others in accordance with these notice provisions:

- (a) If to Acquiror, to:

Nauticus Robotics, Inc.
17146 Feathercraft Lane, Suite 450
Webster, TX 77598
Attention: Nicolaus Radford, CEO & CTO
Email: nradford@houstonmechatronics.com

with a copy to (which shall not constitute notice):

Winston & Strawn LLP
800 Capitol Street, Suite 2400
Houston, TX 77002
Attn: Michael Blankenship
Facsimile No.: (713) 651-2678
Email: mblankenship@winston.com

- (b) If to the Holder, to the address set forth on the Holder's signature page hereto, with a copy, which shall not constitute notice, to:

[•]
Attention: [•]
Phone: [•]
E-mail: [•]

or to such other address as any party may have furnished to the others in writing in accordance herewith.

6. Enumeration and Headings. The enumeration and headings contained in this Agreement are for convenience of reference only and shall not control or affect the meaning or construction of any of the provisions of this Agreement.

7. Counterparts. This Agreement may be executed in facsimile and in any number of counterparts, each of which when so executed and delivered shall be deemed an original, but all of which shall together constitute one and the same agreement.

8. Successors and Assigns. This Agreement and the terms, covenants, provisions and conditions hereof shall be binding upon, and shall inure to the benefit of, the respective heirs, successors and assigns of the parties hereto. The Holder hereby acknowledges and agrees that this Agreement is entered into for the benefit of and is enforceable by Acquiror and its successors and assigns.

9. Severability. If any provision of this Agreement is held to be invalid or unenforceable for any reason, such provision will be conformed to prevailing law rather than voided, if possible, in order to achieve the intent of the parties and, in any event, the remaining provisions of this Agreement shall remain in full force and effect and shall be binding upon the parties hereto.

10. Amendment. This Agreement may be amended or modified by written agreement executed by each of the parties hereto.

[Table of Contents](#)

11. Further Assurances. Each party shall do and perform, or cause to be done and performed, all such further acts and things, and shall execute and deliver all such other agreements, certificates, instruments and documents, as any other party may reasonably request in order to carry out the intent and accomplish the purposes of this Agreement and the consummation of the transactions contemplated hereby.

12. No Strict Construction. The language used in this Agreement will be deemed to be the language chosen by the parties to express their mutual intent, and no rules of strict construction will be applied against any party.

13. Governing Law. The terms and provisions of this Agreement shall be construed in accordance with the laws of the State of Delaware.

14. Controlling Agreement. To the extent the terms of this Agreement (as amended, supplemented, restated or otherwise modified from time to time) directly conflicts with a provision in the Merger Agreement, the terms of this Agreement shall control.

[Signature Page Follows]

[Table of Contents](#)

IN WITNESS WHEREOF, the parties hereto have caused this Lock-up Agreement to be duly executed by their respective authorized signatories as of the date first indicated above.

Nauticus Robotics, Inc., f/k/a CleanTech Acquisition Corp.
By: _____
Name: _____
Title: _____

[Table of Contents](#)

IN WITNESS WHEREOF, the parties hereto have caused this Lock-up Agreement to be duly executed by their respective authorized signatories as of the date first indicated above.

HOLDER
By: _____
Name: _____
Address: _____
[•]
NUMBER OF LOCK-UP SHARES:
[•]

EXHIBIT H-2

FORM OF SPONSOR LOCK-UP AGREEMENT

THIS LOCK-UP AGREEMENT (this “Agreement”) is dated as of [•], 2021, by and between the undersigned (the “Holder”) and Nauticus Robotics, Inc., a Delaware company, f/k/a CleanTech Acquisition Corp. (the “Acquiror”). Capitalized terms used and not otherwise defined herein shall have the meanings given such terms in the Merger Agreement (as defined below).

BACKGROUND

A. Acquiror, CleanTech Merger Sub, Inc., a Texas company and wholly-owned subsidiary of Acquiror (the “Merger Sub”), and Nauticus Robotics (Texas), Inc., a Texas corporation (f/k/a Nauticus Robotics, Inc. and prior to December [], 2021, Houston Mechatronics, Inc.) (the “Company”), entered into an Agreement and Plan of Merger dated as of [•], 2021 (the “Merger Agreement”).

B. Pursuant to the Merger Agreement, the Acquiror will become the 100% stockholder of the Company (the “Transaction”).

C. In order to induce Acquiror and the Company to proceed with the Transaction and for other good and valuable consideration, the receipt and sufficiency of which are hereby acknowledged, the Holder, intending to be legally bound, agrees as follows.

AGREEMENT

1. Lock-Up.

(a) During the Lock-up Period (as defined below), the Holder irrevocably agrees that it, he or she will not offer, sell, contract to sell, pledge or otherwise dispose of, directly or indirectly, any of the Lock-up Shares (as defined below), enter into a transaction that would have the same effect, or enter into any swap, hedge or other arrangement that transfers, in whole or in part, any of the economic consequences of ownership of such Lock-up Shares, whether any of these transactions are to be settled by delivery of any such Lock-up Shares, in cash or otherwise, publicly disclose the intention to make any offer, sale, pledge or disposition, or to enter into any transaction, swap, hedge or other arrangement, or engage in any Short Sales (as defined below) with respect to any security of Acquiror.

(b) In furtherance of the foregoing, Acquiror will (i) place an irrevocable stop order on all Lock-up Shares, including those which may be covered by a registration statement, and (ii) notify Acquiror’s transfer agent in writing of the stop order and the restrictions on such Lock-up Shares under this Agreement and direct Acquiror’s transfer agent not to process any attempts by the Holder to resell or transfer any Lock-up Shares, except in compliance with this Agreement.

(c) For purposes hereof, “Short Sales” include, without limitation, all “short sales” as defined in Rule 200 promulgated under Regulation SHO under the Securities Exchange Act of 1934, as amended (the “Exchange Act”), and all types of direct and indirect stock pledges, forward sale contracts, options, puts, calls, swaps and similar arrangements (including on a total return basis), and sales and other transactions through non-US broker dealers or foreign regulated brokers.

(d) For purpose of this Agreement, the “Lock-up Period” means the period commencing on the Closing Date and ending on the earlier of (i) the one year anniversary of the Closing Date (ii) the date on which the VWAP of shares of PubCo’s Common Stock equals or exceeds \$13.00 per share for twenty (20) of any thirty (30) consecutive trading days commencing after the Closing on Nasdaq and (iii) the date specified in a written waiver of the provisions of this Agreement duly executed by the Acquiror.

The restrictions set forth herein shall not apply to: (1) transfers or distributions to the Holder’s current or former general or limited partners, managers or members, stockholders, other equity holders or direct or indirect affiliates (within the meaning of Rule 405 under the Securities Act of 1933, as amended) or to the estates of any of the foregoing; (2) transfers by bona fide gift to a member of the Holder’s immediate family or to a trust, the beneficiary of which is the Holder or a member of the Holder’s immediate family for estate planning purposes; (3) by virtue of the laws of descent and distribution upon death of the Holder; or (4) pursuant to a qualified domestic relations order, in each case where such transferee agrees to be bound by the terms of this Agreement.

[Table of Contents](#)

In addition, after the Closing Date, if there is a Change of Control, then upon the consummation of such Change of Control, all Lock-up Shares shall be released from the restrictions contained herein. A “Change of Control” means: (a) the sale of all or substantially all of the consolidated assets of Acquiror and Acquiror subsidiaries to a third-party acquiror; (b) a sale resulting in no less than a majority of the voting power of the Acquiror being held by person that did not own a majority of the voting power prior to such sale; or (c) a merger, consolidation, recapitalization or reorganization of Acquiror with or into a third-party acquiror that results in the inability of the pre-transaction equity holders to designate or elect a majority of the Board of Directors (or its equivalent) of the resulting entity or its parent company.

Each of the applicable Holders, Chardan Capital Markets, LLC (“Chardan”), Acquiror and Continental Stock Transfer & Trust Company (the “Escrow Agent”), hereby agree that the lock-up provisions in this Section 1 shall supersede the escrow and release provisions contained in that certain stock escrow agreement, dated July 14, 2021, by and among the applicable Holders, Acquiror, Chardan and the Escrow Agent (the “Stock Escrow Agreement”), and the Stock Escrow Agreement shall be void and of no further effect.

1. Representations and Warranties. Each of the parties hereto, by their respective execution and delivery of this Agreement, hereby represents and warrants to the others and to all third party beneficiaries of this Agreement that (a) such party has the full right, capacity and authority to enter into, deliver and perform its respective obligations under this Agreement, (b) this Agreement has been duly executed and delivered by such party and is the binding and enforceable obligation of such party, enforceable against such party in accordance with the terms of this Agreement, and (c) the execution, delivery and performance of such party’s obligations under this Agreement will not conflict with or breach the terms of any other agreement, contract, commitment or understanding to which such party is a party or to which the assets or securities of such party are bound.

2. Beneficial Ownership. The Holder hereby represents and warrants that it does not beneficially own, directly or through its nominees (as determined in accordance with Section 13(d) of the Exchange Act, and the rules and regulations promulgated thereunder), any shares of capital stock of Acquiror, or any economic interest in or derivative of such stock, other than those securities specified on the signature page hereto. For purposes of this Agreement, the shares of the Acquiror beneficially owned by the Holder as specified on the signature hereto are collectively referred to as the “Lock-up Shares.”

3. No Additional Fees/Payment. Other than the consideration specifically referenced herein, the parties hereto agree that no fee, payment or additional consideration in any form has been or will be paid to the Holder in connection with this Agreement.

4. Notices. Any notices required or permitted to be sent hereunder shall be sent in writing, addressed as specified below, and shall be deemed given: (a) if by hand or recognized courier service, by 4:00 PM on a business day, addressee’s day and time, on the date of delivery, and otherwise on the first business day after such delivery; (b) if by fax or email, on the date that transmission is confirmed electronically, if by 4:00PM on a business day, addressee’s day and time, and otherwise on the first business day after the date of such confirmation; or (c) five days after mailing by certified or registered mail, return receipt requested. Notices shall be addressed to the respective parties as follows (excluding telephone numbers, which are for convenience only), or to such other address as a party shall specify to the others in accordance with these notice provisions:

(a) If to Acquiror, to:

Nauticus Robotics, Inc.
17146 Feathercraft Lane, Suite 450
Webster, TX 77598
Attention: Nicolaus Radford, CEO & CTO
Email: nradford@houstonmechatronics.com

with a copy to (which shall not constitute notice):

Winston & Strawn LLP
800 Capitol Street, Suite 2400
Houston, TX 77002
Attn: Michael Blankenship
Facsimile No.: (713) 651-2678
Email: mblankenship@winston.com

[Table of Contents](#)

- (b) If to the Holder, to the address set forth on the Holder's signature page hereto, with a copy, which shall not constitute notice, to:

[•]

Attention: [•]

Phone: [•]

E-mail: [•]

or to such other address as any party may have furnished to the others in writing in accordance herewith.

5. Enumeration and Headings. The enumeration and headings contained in this Agreement are for convenience of reference only and shall not control or affect the meaning or construction of any of the provisions of this Agreement.

6. Counterparts. This Agreement may be executed in facsimile and in any number of counterparts, each of which when so executed and delivered shall be deemed an original, but all of which shall together constitute one and the same agreement.

7. Successors and Assigns. This Agreement and the terms, covenants, provisions and conditions hereof shall be binding upon, and shall inure to the benefit of, the respective heirs, successors and assigns of the parties hereto. The Holder hereby acknowledges and agrees that this Agreement is entered into for the benefit of and is enforceable by Acquiror and its successors and assigns.

8. Severability. If any provision of this Agreement is held to be invalid or unenforceable for any reason, such provision will be conformed to prevailing law rather than voided, if possible, in order to achieve the intent of the parties and, in any event, the remaining provisions of this Agreement shall remain in full force and effect and shall be binding upon the parties hereto.

9. Amendment. This Agreement may be amended or modified by written agreement executed by each of the parties hereto.

10. Further Assurances. Each party shall do and perform, or cause to be done and performed, all such further acts and things, and shall execute and deliver all such other agreements, certificates, instruments and documents, as any other party may reasonably request in order to carry out the intent and accomplish the purposes of this Agreement and the consummation of the transactions contemplated hereby.

11. No Strict Construction. The language used in this Agreement will be deemed to be the language chosen by the parties to express their mutual intent, and no rules of strict construction will be applied against any party.

12. Governing Law. The terms and provisions of this Agreement shall be construed in accordance with the laws of the State of Delaware.

13. Controlling Agreement. To the extent the terms of this Agreement (as amended, supplemented, restated or otherwise modified from time to time) directly conflicts with a provision in the Merger Agreement, the terms of this Agreement shall control.

[Signature Page Follows]

[Table of Contents](#)

IN WITNESS WHEREOF, the parties hereto have caused this Lock-up Agreement to be duly executed by their respective authorized signatories as of the date first indicated above.

<p>Nauticus Robotics, Inc., f/k/a CleanTech Acquisition Corp.</p>
<p>By: _____ Name: Title:</p>
<p>Chardan Capital Markets, LLC (solely with respect to the last paragraph of Section 1)</p>
<p>By: _____ Name: Title:</p>
<p>Continental Stock Transfer & Trust Company (solely with respect to the last paragraph of Section 1)</p>
<p>By: _____ Name: Title:</p>

[Table of Contents](#)

IN WITNESS WHEREOF, the parties hereto have caused this Lock-up Agreement to be duly executed by their respective authorized signatories as of the date first indicated above.

HOLDER
By: _____
Name: _____
Address: [•]
NUMBER OF LOCK-UP SHARES: [•]

EXHIBIT I

Final Form

AMENDED AND RESTATED
REGISTRATION RIGHTS AGREEMENT

THIS AMENDED AND RESTATED REGISTRATION RIGHTS AGREEMENT (this “**Agreement**”) is entered into as of [•], 2021, by and among CleanTech Acquisition Corp., a Delaware corporation (the “**Company**”) and the undersigned parties listed under Investor on the signature page hereto (each, an “**Investor**” and collectively, the “**Investors**”).

WHEREAS, the Company entered into that certain Agreement and Plan of Merger (this “**Agreement**”), dated as of [•], 2021, by and among the Company, CleanTech Merger Sub, Inc., a Texas corporation (“**Merger Sub**”), Nauticus Robotics, Inc., a Texas corporation (f/k/a Houston Mechatronics, Inc.) (“**Nauticus**”), and Nicolaus Radford (the “**Founder**”), solely in his capacity as the Stockholder Representative;

WHEREAS, certain of the Investors (the “**Sponsor Group**”) are party to that certain Registration Rights Agreement, dated July 14, 2021 (the “**Prior Agreement**”), pursuant to which the Company provided the Sponsor Group with certain rights relating to the registration of the securities held by them; and

WHEREAS, as a condition of, and as a material inducement for Nauticus to enter into and consummate the transactions contemplated by the Merger Agreement, the Company and the Sponsor Group have agreed to amend and restate the Prior Agreement to provide certain rights relating to the registration of shares of Common Stock (as defined below) held by stockholders of Nauticus, as of and contingent upon the closing of the Business Combination.

NOW, THEREFORE, in consideration of the mutual covenants and agreements set forth herein, and for other good and valuable consideration, the receipt and sufficiency of which are hereby acknowledged, the parties hereto agree that the Prior Agreement is hereby amended and restated in its entirety, as of and contingent upon the closing of the Business Combination as follows:

1. **DEFINITIONS.** The following capitalized terms used herein have the following meanings:

“**Agreement**” means this Agreement, as amended, restated, supplemented, or otherwise modified from time to time.

“**Closing Date**” means the closing date of the Business Combination and has the meaning set forth in Section 2.03 of the Merger Agreement.

“**Commission**” means the Securities and Exchange Commission, or any other federal agency then administering the Securities Act or the Exchange Act.

“**Common Stock**” means the common stock, par value \$0.0001 per share, of the Company.

“**Company**” is defined in the preamble to this Agreement.

“**Demand Registration**” is defined in Section 2.1.2.

“**Demanding Holder**” is defined in Section 2.1.1.

“**Exchange Act**” means the Securities Exchange Act of 1934, as amended, and the rules and regulations of the Commission promulgated thereunder, all as the same shall be in effect at the time.

“**Indemnified Party**” is defined in Section 4.3.

“**Indemnifying Party**” is defined in Section 4.3.

“**Investor**” is defined in the preamble to this Agreement.

“**Investor Indemnified Party**” is defined in Section 4.1.

“**Maximum Number of Shares**” is defined in Section 2.1.4.

[Table of Contents](#)

“**Notices**” is defined in Section 7.4.

“**Piggy-Back Registration**” is defined in Section 2.2.1.

“**Private Warrants**” means the aggregate of up to 7,175,000 Warrants CleanTech Sponsor I LLC and CleanTech Investments, LLC, each an Investor, are privately purchasing simultaneously with the consummation of the Company’s initial public offering.

“**Register**,” “**Registered**” and “**Registration**” mean a registration effected by preparing and filing a registration statement or similar document in compliance with the requirements of the Securities Act, and the applicable rules and regulations promulgated thereunder, and such registration statement becoming effective.

“**Registrable Securities**” means (A) all shares of Common Stock (i) issued or issuable to Investors in connection with the Business Combination (including shares of Common Stock that may be issued after the closing of the Business Combination pursuant to the Merger Agreement) and (ii) held by the Sponsor Group immediately after the closing of the Business Combination (including shares of Common Stock acquired by the Sponsor Group in connection with the Business Combination and underlying the Private Warrants), and (B) all outstanding Private Warrants. Registrable Securities include any warrants, shares of capital stock or other securities of the Company issued as a dividend or other distribution with respect to or in exchange for or in replacement of such shares of Common Stock (including shares of Common Stock underlying the Private Warrants). As to any particular Registrable Securities, such securities shall cease to be Registrable Securities when: (a) a Registration Statement with respect to the sale of such securities shall have become effective under the Securities Act and such securities shall have been sold, transferred, disposed of or exchanged in accordance with such Registration Statement; (b) such securities shall have been otherwise transferred, new certificates for them not bearing a legend restricting further transfer shall have been delivered by the Company and subsequent public distribution of them shall not require registration under the Securities Act; (c) such securities shall have ceased to be outstanding, or (d) the Registrable Securities are freely saleable under Rule 144 under the Securities Act without volume limitations.

“**Registration Statement**” means a registration statement filed by the Company with the Commission in compliance with the Securities Act and the rules and regulations promulgated thereunder for a public offering and sale of Common Stock (other than a registration statement on Form S-4 or Form S-8, or their successors, or any registration statement covering only securities proposed to be issued in exchange for securities or assets of another entity).

“**Securities Act**” means the Securities Act of 1933, as amended, and the rules and regulations of the Commission promulgated thereunder, all as the same shall be in effect at the time.

“**Underwriter**” means a securities dealer who purchases any Registrable Securities as principal in an underwritten offering and not as part of such dealer’s market-making activities.

“**Underwritten Offering**” means a Registration in which securities of the Company are sold to an Underwriter in a firm commitment underwriting for distribution to the public.

“**Warrant(s)**” means the warrants of the Company.

2. REGISTRATION RIGHTS.

2.1 Registration Statement

2.1.1 **Registration Statement.** The Company shall, as soon as practicable after the Closing, but in any event within thirty (30) days following the date hereof, file a Registration Statement under the Securities Act to permit the public resale of all the Registrable Securities held by the Investors from time to time as permitted by Rule 415 under the Securities Act (or any successor or similar provision adopted by the Commission then in effect) on the terms and conditions specified in this [Section 2.1.1](#) and shall use its reasonable best efforts to cause such Registration Statement to be declared effective as soon as practicable after the filing thereof, but in any event no later than the earlier of (i) forty-five (45) days (or ninety (90) days if the Commission notifies the Company that it will “review” the Registration Statement) after the date hereof and (ii) the tenth (10th) Business Day after the date the Company is notified (orally or in writing, whichever is earlier) by the Commission that such Registration Statement will not be “reviewed” or will not be subject to further review (such earlier date, the “**Effectiveness Deadline**”). The Registration Statement filed with the Commission pursuant to this [Section 2.1.1](#) shall be on Form S-1 or such other form of registration statement as is then available to effect a registration for resale of such Registrable Securities, covering such Registrable Securities,

and shall contain a Prospectus in such form as to permit any Stockholder to sell such Registrable Securities pursuant to Rule 144 under the Securities Act (or any successor or similar provision adopted by the Commission then in effect) at any time beginning on the effective date for such Registration Statement. A Registration Statement filed pursuant to this [Section 2.1.1](#) shall provide for the resale pursuant to any method or combination of methods legally available to, and requested by, the Stockholders. The Company shall use its reasonable best efforts to cause a Registration Statement filed pursuant to this [Section 2.1.1](#) to remain effective, and to be supplemented and amended to the extent necessary to ensure that such Registration Statement is available or, if not available, that another registration statement is available, for the resale of all the Registrable Securities held by the Stockholders until all such Registrable Securities have ceased to be Registrable Securities. As soon as practicable following the effective date of a Registration Statement filed pursuant to this [Section 2.1.1](#), but in any event within three (3) Business Days of such date, the Company shall notify the Investors of the effectiveness of such Registration Statement. When effective, a Registration Statement filed pursuant to this [Section 2.1.1](#) (including any documents incorporated therein by reference) will comply as to form in all material respects with all applicable requirements of the Securities Act and the Exchange Act and will not contain an untrue statement of a material fact or omit to state a material fact required to be stated therein or necessary to make the statements therein not misleading (in the case of any Prospectus contained in such Registration Statement, in the light of the circumstances under which such statement is made).

2.1.2 Underwritten Offering. In the event that following the expiration of the applicable lockup period, any Investor or group of Investors elects to dispose of Registrable Securities under a Registration Statement pursuant to an Underwritten Offering of all or part of such Registrable Securities that are registered by such Registration Statement (the “**Demand Registration**”) and reasonably expects aggregate gross proceeds in excess of \$5,000,000 (the “**Minimum Amount**”) from such Underwritten Offering, then the Company shall, upon the written demand of such Investor or group of Investors (any such Stockholder a “**Demanding Holder**” and, collectively, the “**Demanding Holders**”), enter into an underwriting agreement in a form as is customary in Underwritten Offerings of equity securities with the managing Underwriter or Underwriters selected by the Company after consultation with the Demanding Holders and shall take all such other reasonable actions as are requested by the managing Underwriter or Underwriters in order to expedite or facilitate the disposition of such Registrable Securities; provided, however, that the Company shall have no obligation to facilitate or participate in more than (i) one (1) Underwritten Offering at the request of Demanding Holders that are a member of the Sponsor Group, and (ii) one (1) Underwritten Offering at the request of Demanding Holders that are not members of the Sponsor Group.

The Company shall give prompt written notice to each other Investor regarding any such proposed Underwritten Offering, and such notice shall offer such Stockholder the opportunity to include in the Underwritten Offering such number of Registrable Securities as each such Investor may request. Each such Investor shall make such request in writing to the Company within five (5) Business Days after the receipt of any such notice from the Company, which request shall specify the number of Registrable Securities intended to be disposed of by such Investor. In connection with any Underwritten Offering contemplated by this [Section 2.1.3](#), the underwriting agreement into which each Demanding Holder and the Company shall enter shall contain such representations, covenants, indemnities (subject to [Section 5.05](#)) and other rights and obligations as are customary in underwritten offerings of equity securities. No Demanding Holder shall be required to make any representations or warranties to or agreements with the Company or the Underwriters other than representations, warranties or agreements regarding such Demanding Holder’s authority to enter into such underwriting agreement and to sell, and its ownership of, the securities being registered on its behalf, its intended method of distribution and any other representation required by law.

2.1.3 Reduction of Offering. If the managing Underwriter or Underwriters for a Demand Registration that is to be an underwritten offering advises the Company and the Demanding Holders in writing that the dollar amount or number of shares of Registrable Securities which the Demanding Holders desire to sell, taken together with all other shares of Common Stock or other securities which the Company desires to sell and the shares of Common Stock, if any, as to which registration has been requested pursuant to written contractual piggy-back registration rights held by other shareholders of the Company who desire to sell, exceeds the maximum dollar amount or maximum number of shares that can be sold in such offering without adversely affecting the proposed offering price, the timing, the distribution method, or the probability of success of such offering (such maximum dollar amount or maximum number of shares, as applicable, the “**Maximum Number of Shares**”), then the Company shall include in such registration: (i) first, the Registrable Securities as to which Demand Registration has been requested by the Demanding Holders (pro rata in accordance with the number of shares that each such Person has requested be included in such registration, regardless of the number of shares held by each such Person (such proportion is referred to herein

as “**Pro Rata**”) that can be sold without exceeding the Maximum Number of Shares; (ii) second, to the extent that the Maximum Number of Shares has not been reached under the foregoing clause (i), the shares of Common Stock or other securities that the Company desires to sell that can be sold without exceeding the Maximum Number of Shares; and (iii) third, to the extent that the Maximum Number of Shares has not been reached under the foregoing clauses (i) and (ii), the shares of Common Stock or other securities for the account of other persons that the Company is obligated to register pursuant to written contractual arrangements with such persons and that can be sold without exceeding the Maximum Number of Shares.

2.1.4 Withdrawal. If a majority-in-interest of the Demanding Holders disapprove of the terms of any underwriting or are not entitled to include all of their Registrable Securities in any offering, such majority-in-interest of the Demanding Holders may elect to withdraw from such offering by giving written notice to the Company and the Underwriter or Underwriters of their request to withdraw prior to the effectiveness of the Registration Statement filed with the Commission with respect to such Demand Registration.

2.2 Piggy-Back Registration.

2.2.1 Piggy-Back Rights. If at any time on or after the Closing Date of the Business Combination, the Company proposes to file a Registration Statement under the Securities Act with respect to an offering of equity securities, or securities or other obligations exercisable or exchangeable for, or convertible into, equity securities, by the Company for its own account or for shareholders of the Company for their account (or by the Company and by shareholders of the Company including, without limitation, pursuant to Section 2.1), other than a Registration Statement (i) filed in connection with any employee stock option or other benefit plan, (ii) for an exchange offer or offering of securities solely to the Company’s existing shareholders, (iii) for an offering of debt that is convertible into equity securities of the Company or (iv) for a dividend reinvestment plan, then the Company shall (x) give written notice of such proposed filing to the holders of Registrable Securities as soon as practicable but in no event less than ten (10) days before the anticipated filing date, which notice shall describe the amount and type of securities to be included in such offering, the intended method(s) of distribution, and the name of the proposed managing Underwriter or Underwriters, if any, of the offering, and (y) offer to the holders of Registrable Securities in such notice the opportunity to register the sale of such number of shares of Registrable Securities as such holders may request in writing within five (5) days following receipt of such notice (a “**Piggy-Back Registration**”). The Company shall cause such Registrable Securities to be included in such registration and shall use its best efforts to cause the managing Underwriter or Underwriters of a proposed underwritten offering to permit the Registrable Securities requested to be included in a Piggy-Back Registration on the same terms and conditions as any similar securities of the Company and to permit the sale or other disposition of such Registrable Securities in accordance with the intended method(s) of distribution thereof. All holders of Registrable Securities proposing to distribute their securities through a Piggy-Back Registration that involves an Underwriter or Underwriters shall enter into an underwriting agreement (including a market stand-off agreement if required by such underwriter or underwriters) in customary form with the Underwriter or Underwriters selected for such Piggy-Back Registration. Notwithstanding the provisions set forth in the immediately preceding sentences, the right to a Piggy-Back Registration set forth under this Section 2.2.1 with respect to the Registrable Securities shall terminate on the seventh anniversary of the date hereof.

2.2.2 Reduction of Offering. If the managing Underwriter or Underwriters for a Piggy-Back Registration that is to be an underwritten offering advises the Company and the holders of Registrable Securities in writing that the dollar amount or number of shares of Common Stock which the Company desires to sell, taken together with the shares of Common Stock, if any, as to which Registration has been demanded pursuant to written contractual arrangements with persons other than the holders of Registrable Securities hereunder, the Registrable Securities as to which Registration has been requested under this Section 2.2, and the shares of Common Stock, if any, as to which Registration has been requested pursuant to the written contractual piggy-back registration rights of other shareholders of the Company, exceeds the Maximum Number of Shares, then the Company shall include in any such Registration:

- (a) If the Registration is undertaken for the Company’s account: (A) first, the shares of Common Stock or other securities that the Company desires to sell that can be sold without exceeding the Maximum Number of Shares; (B) second, to the extent that the Maximum Number of Shares has not been reached under the foregoing clause (A), the shares of Common Stock or other securities, if any, comprised of Registrable Securities, the shares of Common Stock or other securities for the account of other persons that the Company is obligated to register, as to

which Registration has been requested pursuant to the applicable written contractual piggy-back registration rights of such security holders, Pro Rata, that can be sold without exceeding the Maximum Number of Shares; and (C) third, to the extent that the Maximum Number of shares has not been reached under the foregoing clauses (A) and (B), the shares of Common Stock or other securities for the account of other persons that the Company is obligated to register pursuant to written contractual piggy-back registration rights with such persons and that can be sold without exceeding the Maximum Number of Shares;

(b) If the registration is Demand Registration undertaken at the demand of persons other than either the holders of Registrable Securities, (A) first, the shares of Common Stock or other securities for the account of the demanding persons that can be sold without exceeding the Maximum Number of Shares; (B) second, to the extent that the Maximum Number of Shares has not been reached under the foregoing clause (A), the shares of Common Stock or other securities that the Company desires to sell that can be sold without exceeding the Maximum Number of Shares; (C) third, to the extent that the Maximum Number of Shares has not been reached under the foregoing clauses (A) and (B), collectively the shares of Common Stock or other securities comprised of Registrable Securities, Pro Rata, as to which Registration has been requested pursuant to the terms hereof, that can be sold without exceeding the Maximum Number of Shares; and (D) fourth, to the extent that the Maximum Number of Shares has not been reached under the foregoing clauses (A), (B) and (C), the shares of Common Stock or other securities for the account of other persons that the Company is obligated to register pursuant to written contractual arrangements with such persons, that can be sold without exceeding the Maximum Number of Shares.

2.2.3 Withdrawal. Any holder of Registrable Securities may elect to withdraw such holder's request for inclusion of Registrable Securities in any Piggy-Back Registration by giving written notice to the Company of such request to withdraw prior to the effectiveness of the Registration Statement. The Company (whether on its own determination or as the result of a withdrawal by persons making a demand pursuant to written contractual obligations) may withdraw a Registration Statement at any time prior to the effectiveness of such Registration Statement. Notwithstanding any such withdrawal, the Company shall pay all expenses incurred by the holders of Registrable Securities in connection with such Piggy-Back Registration as provided in Section 3.3.

2.2.3 Unlimited Piggy-Back Registration Right. For purposes of clarify, any Registration effected pursuant to Section 2.2 hereof shall not be counted as a Registration pursuant to a Demand Registration effected under Section 2.1 hereof.

3. REGISTRATION PROCEDURES.

3.1 Filings; Information. Whenever the Company is required to effect the Registration of any Registrable Securities pursuant to Section 2, the Company shall use its best efforts to effect the registration and sale of such Registrable Securities in accordance with the intended method(s) of distribution thereof as expeditiously as practicable, and in connection with any such request:

3.1.1 Filing Registration Statement. The Company shall use its best efforts to, as expeditiously as possible after receipt of a request for a Demand Registration pursuant to Section 2.1, prepare and file with the Commission a Registration Statement on any form for which the Company then qualifies or which counsel for the Company shall deem appropriate and which form shall be available for the sale of all Registrable Securities to be registered thereunder in accordance with the intended method(s) of distribution thereof, and shall use its best efforts to cause such Registration Statement to become effective and use its best efforts to keep it effective for the period required by Section 3.1.3; provided, however, that the Company shall have the right to defer any Demand Registration for up to sixty (60) days, and any Piggy-Back Registration for such period as may be applicable to deferment of any Demand Registration to which such Piggy-Back Registration relates, in each case if the Company shall furnish to the holders a certificate signed by the Chief Executive Officer or Chairman of the Company stating that, in the good faith judgment of the Board of Directors of the Company, it would be materially detrimental to the Company and its shareholders for such Registration Statement to be effected at such time; provided further, however, that the Company shall not have the right to exercise the right set forth in the immediately preceding proviso more than once in any 365-day period in respect of a Demand Registration hereunder.

3.1.2 Copies. The Company shall, prior to filing a Registration Statement or prospectus, or any amendment or supplement thereto, furnish without charge to the holders of Registrable Securities included in such registration, and such holders' legal counsel, copies of such Registration Statement as proposed to be filed, each amendment and supplement to such Registration Statement (in each case including all exhibits thereto and documents incorporated by reference therein), the prospectus included in such Registration Statement (including each preliminary prospectus), and such other documents as the holders of Registrable Securities included in such registration or legal counsel for any such holders may request in order to facilitate the disposition of the Registrable Securities owned by such holders.

3.1.3 Amendments and Supplements. The Company shall prepare and file with the Commission such amendments, including post-effective amendments, and supplements to such Registration Statement and the prospectus used in connection therewith as may be necessary to keep such Registration Statement effective and in compliance with the provisions of the Securities Act until all Registrable Securities and other securities covered by such Registration Statement have been disposed of in accordance with the intended method(s) of distribution set forth in such Registration Statement or such securities have been withdrawn.

3.1.4 Notification. After the filing of a Registration Statement, the Company shall promptly, and in no event more than two (2) business days after such filing, notify the holders of Registrable Securities included in such Registration Statement of such filing, and shall further notify such holders promptly and confirm such advice in writing in all events within two (2) business days of the occurrence of any of the following: (i) when such Registration Statement becomes effective; (ii) when any post-effective amendment to such Registration Statement becomes effective; (iii) the issuance or threatened issuance by the Commission of any stop order (and the Company shall take all actions required to prevent the entry of such stop order or to remove it if entered); and (iv) any request by the Commission for any amendment or supplement to such Registration Statement or any prospectus relating thereto or for additional information or of the occurrence of an event requiring the preparation of a supplement or amendment to such prospectus so that, as thereafter delivered to the purchasers of the securities covered by such Registration Statement, such prospectus will not contain an untrue statement of a material fact or omit to state any material fact required to be stated therein or necessary to make the statements therein not misleading, and promptly make available to the holders of Registrable Securities included in such Registration Statement any such supplement or amendment; except that before filing with the Commission a Registration Statement or prospectus or any amendment or supplement thereto, including documents incorporated by reference, the Company shall furnish to the holders of Registrable Securities included in such Registration Statement and to the legal counsel for any such holders, copies of all such documents proposed to be filed sufficiently in advance of filing to provide such holders and legal counsel with a reasonable opportunity to review such documents and comment thereon, and the Company shall not file any Registration Statement or prospectus or amendment or supplement thereto, including documents incorporated by reference, to which such holders or their legal counsel shall object.

3.1.5 State Securities Laws Compliance. The Company shall use its best efforts to (i) register or qualify the Registrable Securities covered by the Registration Statement under such securities or "blue sky" laws of such jurisdictions in the United States as the holders of Registrable Securities included in such Registration Statement (in light of their intended plan of distribution) may request and (ii) take such action necessary to cause such Registrable Securities covered by the Registration Statement to be registered with or approved by such other governmental authorities as may be necessary by virtue of the business and operations of the Company and do any and all other acts and things that may be necessary or advisable to enable the holders of Registrable Securities included in such Registration Statement to consummate the disposition of such Registrable Securities in such jurisdictions; provided, however, that the Company shall not be required to qualify generally to do business in any jurisdiction where it would not otherwise be required to qualify but for this paragraph or subject itself to taxation in any such jurisdiction.

3.1.6 Agreements for Disposition. The Company shall enter into customary agreements (including, if applicable, an underwriting agreement in customary form) and take such other actions as are reasonably required in order to expedite or facilitate the disposition of such Registrable Securities. The representations, warranties and covenants of the Company in any underwriting agreement which are made to or for the benefit of any Underwriters, to the extent applicable, shall also be made to and for the benefit of the holders of Registrable Securities included in such registration statement. No holder of Registrable Securities included in such registration statement shall be required to make any representations or warranties in the underwriting agreement except, if applicable, with respect

[Table of Contents](#)

to such holder's organization, good standing, authority, title to Registrable Securities, lack of conflict of such sale with such holder's material agreements and organizational documents, and with respect to written information relating to such holder that such holder has furnished in writing expressly for inclusion in such Registration Statement.

3.1.7 Cooperation. The principal executive officer of the Company, the principal financial officer of the Company, the principal accounting officer of the Company and all other officers and members of the management of the Company shall cooperate fully in any offering of Registrable Securities hereunder, which cooperation shall include, without limitation, the preparation of the Registration Statement with respect to such offering and all other offering materials and related documents, and participation in meetings with Underwriters, attorneys, accountants and potential investors.

3.1.8 Records. The Company shall make available for inspection by the holders of Registrable Securities included in such Registration Statement, any Underwriter participating in any disposition pursuant to such registration statement and any attorney, accountant or other professional retained by any holder of Registrable Securities included in such Registration Statement or any Underwriter, all financial and other records, pertinent corporate documents and properties of the Company, as shall be necessary to enable them to exercise their due diligence responsibility, and cause the Company's officers, directors and employees to supply all information requested by any of them in connection with such Registration Statement.

3.1.9 Opinions and Comfort Letters. Upon request, the Company shall furnish to each holder of Registrable Securities included in any Registration Statement a signed counterpart, addressed to such holder, of (i) any opinion of counsel to the Company delivered to any Underwriter and (ii) any comfort letter from the Company's independent public accountants delivered to any Underwriter. In the event no legal opinion is delivered to any Underwriter, the Company shall furnish to each holder of Registrable Securities included in such Registration Statement, at any time that such holder elects to use a prospectus, an opinion of counsel to the Company to the effect that the Registration Statement containing such prospectus has been declared effective and that no stop order is in effect.

3.1.10 Earnings Statement. The Company shall comply with all applicable rules and regulations of the Commission and the Securities Act, and make available to its shareholders, as soon as practicable, an earnings statement covering a period of twelve (12) months, which earnings statement shall satisfy the provisions of Section 11(a) of the Securities Act and Rule 158 thereunder.

3.1.11 Listing. The Company shall use its best efforts to cause all Registrable Securities included in any registration to be listed on such exchanges or otherwise designated for trading in the same manner as similar securities issued by the Company are then listed or designated or, if no such similar securities are then listed or designated, in a manner satisfactory to the holders of a majority of the Registrable Securities included in such registration.

3.1.12 Road Show. If the registration involves the registration of Registrable Securities involving gross proceeds in excess of \$5,000,000, the Company shall use its reasonable efforts to make available senior executives of the Company to participate in customary "road show" presentations that may be reasonably requested by the Underwriter in any underwritten offering.

3.2 Obligation to Suspend Distribution. Upon receipt of any notice from the Company of the happening of any event of the kind described in Section 3.1.4(iv), or, upon any suspension by the Company, pursuant to a written insider trading compliance program adopted by the Company's Board of Directors, of the ability of all "insiders" covered by such program to transact in the Company's securities because of the existence of material non-public information, each holder of Registrable Securities included in any Registration shall immediately discontinue disposition of such Registrable Securities pursuant to the Registration Statement covering such Registrable Securities until such holder receives the supplemented or amended prospectus contemplated by Section 3.1.4(iv) or the restriction on the ability of "insiders" to transact in the Company's securities is removed, as applicable, and, if so directed by the Company, each such holder will deliver to the Company all copies, other than permanent file copies then in such holder's possession, of the most recent prospectus covering such Registrable Securities at the time of receipt of such notice.

3.3 Registration Expenses. The Company shall bear all costs and expenses incurred in connection with any Demand Registration pursuant to Section 2.1, any Piggy-Back Registration pursuant to Section 2.2, , and all expenses incurred in performing or complying with its other obligations under this Agreement, whether or not the Registration Statement becomes effective, including, without limitation: (i) all registration and filing fees; (ii) fees and expenses of compliance with securities or “blue sky” laws (including fees and disbursements of counsel in connection with blue sky qualifications of the Registrable Securities); (iii) printing expenses; (iv) the Company’s internal expenses (including, without limitation, all salaries and expenses of its officers and employees); (v) the fees and expenses incurred in connection with the listing of the Registrable Securities as required by Section 3.1.11; (vi) Financial Industry Regulatory Authority fees; (vii) fees and disbursements of counsel for the Company and fees and expenses for independent certified public accountants retained by the Company (including the expenses or costs associated with the delivery of any opinions or comfort letters requested pursuant to Section 3.1.9); (viii) the reasonable fees and expenses of any special experts retained by the Company in connection with such registration and (ix) the reasonable fees and expenses of one legal counsel selected by the holders of a majority-in-interest of the Registrable Securities included in such registration. The Company shall have no obligation to pay any underwriting discounts or selling commissions attributable to the Registrable Securities being sold by the holders thereof, which underwriting discounts or selling commissions shall be borne by such holders. Additionally, in an underwritten offering, all selling shareholders and the Company shall bear the expenses of the Underwriter pro rata in proportion to the respective amount of shares each is selling in such offering. Notwithstanding any of the foregoing provisions, the Company shall not be required to pay for any expenses of any Registration proceeding begun pursuant to Section 2.1 if the Registration request is subsequently withdrawn at the request of the holders of a majority of the Registrable Securities to be registered (in which case the participating holders requesting for the withdrawal shall bear such expenses), unless, in the case of a registration requested under Section 2.1, all of the holders of the Registrable Securities agree to forfeit their right to one demand registration pursuant to Section 2.1.

3.4 Information. The holders of Registrable Securities shall provide such information as may reasonably be requested by the Company, or the managing Underwriter, if any, in connection with the preparation of any Registration Statement, including amendments and supplements thereto, in order to effect the registration of any Registrable Securities under the Securities Act pursuant to Section 2 and in connection with the Company’s obligation to comply with federal and applicable state securities laws.

4. INDEMNIFICATION AND CONTRIBUTION.

4.1 Indemnification by the Company. The Company agrees to indemnify and hold harmless each Investor and each other holder of Registrable Securities, and each of their respective officers, employees, affiliates, directors, partners, members, attorneys and agents, and each person, if any, who controls an Investor and each other holder of Registrable Securities (within the meaning of Section 15 of the Securities Act or Section 20 of the Exchange Act) (each, an “**Investor Indemnified Party**”), from and against any expenses, losses, judgments, claims, damages or liabilities, whether joint or several, arising out of or based upon any untrue statement (or allegedly untrue statement) of a material fact contained in any Registration Statement under which the sale of such Registrable Securities was registered under the Securities Act, any preliminary prospectus, final prospectus or summary prospectus contained in the Registration Statement, or any amendment or supplement to such Registration Statement, or arising out of or based upon any omission (or alleged omission) to state a material fact required to be stated therein or necessary to make the statements therein not misleading, or any violation by the Company of the Securities Act or any rule or regulation promulgated thereunder applicable to the Company and relating to action or inaction required of the Company in connection with any such registration; and the Company shall promptly reimburse the Investor Indemnified Party for any legal and any other expenses reasonably incurred by such Investor Indemnified Party in connection with investigating and defending any such expense, loss, judgment, claim, damage, liability or action; provided, however, that the Company will not be liable in any such case to the extent that any such expense, loss, claim, damage or liability arises out of or is based upon any untrue statement or allegedly untrue statement or omission or alleged omission made in such Registration Statement, preliminary prospectus, final prospectus, or summary prospectus, or any such amendment or supplement, in reliance upon and in conformity with information furnished to the Company, in writing, by such selling holder expressly for use therein. The Company also shall indemnify any Underwriter of the Registrable Securities, their officers, affiliates, directors, partners, members and agents and each person who controls such Underwriter on substantially the same basis as that of the indemnification provided above in this Section 4.1.

4.2 Indemnification by Holders of Registrable Securities. Each selling holder of Registrable Securities will, in the event that any registration is being effected under the Securities Act pursuant to this Agreement of any Registrable Securities held by such selling holder, indemnify and hold harmless the Company, each of its directors and officers and each Underwriter (if any), and each other selling holder and each other person, if any, who controls another selling holder or such Underwriter within the meaning of the Securities Act, against any losses, claims, judgments, damages or liabilities, whether joint or several, insofar as such losses, claims, judgments, damages or liabilities (or actions in respect thereof) arise out of or are based upon any untrue statement or allegedly untrue statement of a material fact contained in any Registration Statement under which the sale of such Registrable Securities was registered under the Securities Act, any preliminary prospectus, final prospectus or summary prospectus contained in the Registration Statement, or any amendment or supplement to the Registration Statement, or arise out of or are based upon any omission or the alleged omission to state a material fact required to be stated therein or necessary to make the statement therein not misleading, if the statement or omission was made in reliance upon and in conformity with information furnished in writing to the Company by such selling holder expressly for use therein, and shall reimburse the Company, its directors and officers, and each other selling holder or controlling person for any legal or other expenses reasonably incurred by any of them in connection with investigation or defending any such loss, claim, damage, liability or action. Each selling holder's indemnification obligations hereunder shall be several and not joint and shall be limited to the amount of any net proceeds actually received by such selling holder.

4.3 Conduct of Indemnification Proceedings. Promptly after receipt by any person of any notice of any loss, claim, damage or liability or any action in respect of which indemnity may be sought pursuant to Section 4.1 or 4.2, such person (the "Indemnified Party") shall, if a claim in respect thereof is to be made against any other person for indemnification hereunder, notify such other person (the "**Indemnifying Party**") in writing of the loss, claim, judgment, damage, liability or action; provided, however, that the failure by the Indemnified Party to notify the Indemnifying Party shall not relieve the Indemnifying Party from any liability which the Indemnifying Party may have to such Indemnified Party hereunder, except and solely to the extent the Indemnifying Party is actually prejudiced by such failure. If the Indemnified Party is seeking indemnification with respect to any claim or action brought against the Indemnified Party, then the Indemnifying Party shall be entitled to participate in such claim or action, and, to the extent that it wishes, jointly with all other Indemnifying Parties, to assume control of the defense thereof with counsel satisfactory to the Indemnified Party. After notice from the Indemnifying Party to the Indemnified Party of its election to assume control of the defense of such claim or action, the Indemnifying Party shall not be liable to the Indemnified Party for any legal or other expenses subsequently incurred by the Indemnified Party in connection with the defense thereof other than reasonable costs of investigation; provided, however, that in any action in which both the Indemnified Party and the Indemnifying Party are named as defendants, the Indemnified Party shall have the right to employ separate counsel (but no more than one such separate counsel) to represent the Indemnified Party and its controlling persons who may be subject to liability arising out of any claim in respect of which indemnity may be sought by the Indemnified Party against the Indemnifying Party, with the fees and expenses of such counsel to be paid by such Indemnifying Party if, based upon the written opinion of counsel of such Indemnified Party, representation of both parties by the same counsel would be inappropriate due to actual or potential differing interests between them. No Indemnifying Party shall, without the prior written consent of the Indemnified Party, consent to entry of judgment or effect any settlement of any claim or pending or threatened proceeding in respect of which the Indemnified Party is or could have been a party and indemnity could have been sought hereunder by such Indemnified Party, unless such judgment or settlement includes an unconditional release of such Indemnified Party from all liability arising out of such claim or proceeding.

4.4 Contribution.

4.4.1 If the indemnification provided for in the foregoing Sections 4.1, 4.2 and 4.3 is unavailable to any Indemnified Party in respect of any loss, claim, damage, liability or action referred to herein, then each such Indemnifying Party, in lieu of indemnifying such Indemnified Party, shall contribute to the amount paid or payable by such Indemnified Party as a result of such loss, claim, damage, liability or action in such proportion as is appropriate to reflect the relative fault of the Indemnified Parties and the Indemnifying Parties in connection with the actions or omissions which resulted in such loss, claim, damage, liability or action, as well as any other relevant equitable considerations. The relative fault of any Indemnified Party and any Indemnifying Party shall be determined by reference to, among other things, whether the untrue or alleged untrue statement of a material fact or

[Table of Contents](#)

the omission or alleged omission to state a material fact relates to information supplied by such Indemnified Party or such Indemnifying Party and the parties' relative intent, knowledge, access to information and opportunity to correct or prevent such statement or omission.

4.4.2 The parties hereto agree that it would not be just and equitable if contribution pursuant to this Section 4.4 were determined by pro rata allocation or by any other method of allocation which does not take account of the equitable considerations referred to in the immediately preceding Section 4.4.1.

4.4.3 The amount paid or payable by an Indemnified Party as a result of any loss, claim, damage, liability or action referred to in the immediately preceding paragraph shall be deemed to include, subject to the limitations set forth above, any legal or other expenses incurred by such Indemnified Party in connection with investigating or defending any such action or claim. Notwithstanding the provisions of this Section 4.4, no holder of Registrable Securities shall be required to contribute any amount in excess of the dollar amount of the net proceeds (after payment of any underwriting fees, discounts, commissions or taxes) actually received by such holder from the sale of Registrable Securities which gave rise to such contribution obligation. No person guilty of fraudulent misrepresentation (within the meaning of Section 11(f) of the Securities Act) shall be entitled to contribution from any person who was not guilty of such fraudulent misrepresentation.

5. RULE 144.

5.1 Rule 144. The Company covenants that it shall file any reports required to be filed by it under the Securities Act and the Exchange Act and shall take such further action as the holders of Registrable Securities may reasonably request, all to the extent required from time to time to enable such holders to sell Registrable Securities without registration under the Securities Act within the limitation of the exemptions provided by Rule 144 under the Securities Act, as such Rules may be amended from time to time, or any similar rule or regulation hereafter adopted by the Commission.

6. MISCELLANEOUS.

6.1 Termination. The Company's obligation under Section 2 with respect to any Registrable Securities proposed to be sold by a holder in a Registration pursuant to Section 2 shall terminate (i) on the date on which none of the Investors hold any Registrable Securities, (ii) the dissolution, liquidation, or winding up of the Company, or (iii) upon the unanimous agreement of the Investors.

6.2 Limitation on Registration Rights. Notwithstanding anything herein to the contrary, Chardan Capital Markets, LLC and its related persons may not, with respect to the Private Warrants purchased by CleanTech Investments, LLC, (i) have more than one (1) Demand Registration at the Company's expense, (ii) exercise a Demand Registration after July 14, 2026, and (iii) exercise a Piggy-Back Registration after July 14, 2028, as long as Chardan Capital Markets, LLC or any of its related persons are beneficial owners of the Private Warrants held by CleanTech Investments, LLC.

6.3 Assignment; No Third Party Beneficiaries. This Agreement and the rights, duties and obligations of the Company hereunder may not be assigned or delegated by the Company in whole or in part. This Agreement and the rights, duties and obligations of the holders of Registrable Securities hereunder may be freely assigned or delegated by such holder of Registrable Securities in conjunction with and to the extent of any transfer of Registrable Securities by any such holder. This Agreement and the provisions hereof shall be binding upon and shall inure to the benefit of each of the parties, to the permitted assigns of the Investors or holder of Registrable Securities or of any assignee of the Investors or holder of Registrable Securities. This Agreement is not intended to confer any rights or benefits on any persons that are not party hereto other than as expressly set forth in Article 4 and this Section 7.3.

6.4 Notices. All notices, demands, requests, consents, approvals or other communications (collectively, "Notices") required or permitted to be given hereunder or which are given with respect to this Agreement shall be in writing and shall be personally served, delivered by reputable air courier service with charges prepaid, or transmitted by hand delivery, telegram, telex or facsimile, addressed as set forth below, or to such other address as such party shall have specified most recently by written notice. Notice shall be deemed given on the date of service or transmission if personally served or transmitted by telegram, telex or facsimile; provided, that if such service or

[Table of Contents](#)

transmission is not on a business day or is after normal business hours, then such notice shall be deemed given on the next business day. Notice otherwise sent as provided herein shall be deemed given on the next business day following timely delivery of such notice to a reputable air courier service with an order for next-day delivery.

To the Company:

CleanTech Acquisition Corp.
207 West 25th Street, 9th Floor
New York, NY 10001
Attn: Eli Spiro
Email: espiro@axxcesscapital.com

with a copy to:

Loeb & Loeb LLP
345 Park Avenue
New York, NY 10154
Attn: Giovanni Caruso, Esq.
Email: gcaruso@loeb.com

To an Investor, to the address set forth below such Investor's name on the signature pages hereto.

6.5 Severability. This Agreement shall be deemed severable, and the invalidity or unenforceability of any term or provision hereof shall not affect the validity or enforceability of this Agreement or of any other term or provision hereof. Furthermore, in lieu of any such invalid or unenforceable term or provision, the parties hereto intend that there shall be added as a part of this Agreement a provision as similar in terms to such invalid or unenforceable provision as may be possible that is valid and enforceable.

6.6 Counterparts. This Agreement may be executed in multiple counterparts, each of which shall be deemed an original, and all of which taken together shall constitute one and the same instrument.

6.7 Entire Agreement. This Agreement (including all agreements entered into pursuant hereto and all certificates and instruments delivered pursuant hereto and thereto) constitute the entire agreement of the parties with respect to the subject matter hereof and supersede all prior and contemporaneous agreements, representations, understandings, negotiations and discussions between the parties, whether oral or written.

6.8 Modifications and Amendments. No amendment, modification or termination of this Agreement shall be binding upon any party unless executed in writing by such party.

6.9 Titles and Headings. Titles and headings of sections of this Agreement are for convenience only and shall not affect the construction of any provision of this Agreement. No amendment, modification or termination of this Agreement shall be binding upon the holders of the Registrable Securities unless executed in writing by the holders of the majority Registrable Securities.

6.10 Waivers and Extensions. Any party to this Agreement may waive any right, breach or default which such party has the right to waive, provided that such waiver will not be effective against the waiving party unless it is in writing, is signed by such party, and specifically refers to this Agreement. Waivers may be made in advance or after the right waived has arisen or the breach or default waived has occurred. Any waiver may be conditional. No waiver of any breach of any agreement or provision herein contained shall be deemed a waiver of any preceding or succeeding breach thereof nor of any other agreement or provision herein contained. No waiver or extension of time for performance of any obligations or acts shall be deemed a waiver or extension of the time for performance of any other obligations or acts.

[Table of Contents](#)

6.11 Remedies Cumulative. In the event that the Company fails to observe or perform any covenant or agreement to be observed or performed under this Agreement, the Investor or any other holder of Registrable Securities may proceed to protect and enforce its rights by suit in equity or action at law, whether for specific performance of any term contained in this Agreement or for an injunction against the breach of any such term or in aid of the exercise of any power granted in this Agreement or to enforce any other legal or equitable right, or to take any one or more of such actions, without being required to post a bond. None of the rights, powers or remedies conferred under this Agreement shall be mutually exclusive, and each such right, power or remedy shall be cumulative and in addition to any other right, power or remedy, whether conferred by this Agreement or now or hereafter available at law, in equity, by statute or otherwise.

6.12 Governing Law. This Agreement shall be governed by, interpreted under, and construed in accordance with the internal laws of the State of New York applicable to agreements made and to be performed within the State of New York, without giving effect to any choice-of-law provisions thereof that would compel the application of the substantive laws of any other jurisdiction.

6.13 Waiver of Trial by Jury. Each party hereby irrevocably and unconditionally waives the right to a trial by jury in any action, suit, counterclaim or other proceeding (whether based on contract, tort or otherwise) arising out of, connected with or relating to this Agreement, the transactions contemplated hereby, or the actions of the Investor in the negotiation, administration, performance or enforcement hereof.

[REMAINDER OF PAGE INTENTIONALLY LEFT BLANK]

[Table of Contents](#)

IN WITNESS WHEREOF, the parties have caused this Amended and Restated Registration Rights Agreement to be executed and delivered by their duly authorized representatives as of the date first written above.

COMPANY:
CLEANTECH ACQUISITION CORP.
By: _____
Name: Eli Spiro
Title: Chief Executive officer
SPONSOR GROUP:

Bill Richardson

Jon Najarian

Brendan Riley

Douglas Cole

Britt Ide

Allen Weiss

Dan Reicher

CLEANTECH SPONSOR I LLC
By: _____
Name: Eli Spiro
Title: Managing Member
CLEANTECH INVESTMENTS, LLC
By: _____
Name: Jonas Grossman
Title: Managing Member

INVESTOR:

Print Name of Investor

Signature

By: _____
Title: _____

AMENDMENT NO. 1 TO AGREEMENT AND PLAN OF MERGER

This Amendment No. 1 to Agreement and Plan of Merger (this “**Amendment**”), dated as of January 30, 2022, is made and entered into by and among CleanTech Acquisition Corp. (“**CleanTech**”), CleanTech Merger Sub, Inc. (“**Merger Sub**”), Nauticus Robotics, Inc. (“**Nauticus**”), and Nicolaus Radford, solely in his capacity as the stockholder representative (the “**Stockholder Representative**”) pursuant to the designation in Section 11.16 of the Agreement (defined below).

WHEREAS, CleanTech, Merger Sub, Nauticus, and the Stockholder Representative are parties to that certain Agreement and Plan of Merger, dated as of December 16, 2021 (the “**Agreement**”);

WHEREAS, pursuant to Section 11.10 of the Agreement, the Agreement may be amended by a written instrument duly executed in the same manner as the Agreement and which makes reference to the Agreement; and

WHEREAS, CleanTech, Merger Sub, Nauticus, and the Stockholder Representative desire to amend the Agreement as set forth in this Amendment.

NOW, THEREFORE, in consideration of the premises, and for other good and valuable consideration, the receipt and sufficiency of which are hereby acknowledged, the parties hereto hereby agree as follows:

Section 1. Amendments to Section 1.01.

- (a) The definition of “Equity Value in Section 1.01 of the Agreement is hereby amended and restated in its entirety as follows:

““**Equity Value**” means the sum of (i) Three Hundred Million (\$300,000,000) plus (ii) the amount by which (x) the outstanding liabilities and obligations of Acquiror with respect to the Transactions (including with respect to Indebtedness of Acquiror and Outstanding Acquiror Expenses) at the Closing (but prior to repayment thereof at the Closing) exceeds (y) \$35,000,000. For the avoidance of doubt, the amount described in sub-clause (ii) of this definition of Equity Value shall not be less than zero (0) and the Equity Value shall not be less than Three Hundred Million (\$300,000,000).”

- (b) The definition of “Per Share Merger Consideration Value” in Section 1.01 of the Agreement is hereby amended and restated in its entirety as follows:

““**Per Share Merger Consideration Value**” means \$142.069.”

Section 2. Amendment to Section 9.03(g). Section 9.03(g) of the Agreement is hereby amended and restated in its entirety as follows:

“(g) **Minimum Cash Condition.** The aggregate cash available to Acquiror at the Closing from the Trust Account, the ATW Convertible Note and the Equity Financing (after giving effect to the redemption of any shares of Acquiror Common Stock in connection with the Offer and the payment of the Outstanding Acquiror Expenses and the Outstanding Company Expenses) shall equal or exceed \$50,000,000 (the “Minimum Cash Condition”).

Section 3. Ratification of Agreement and Plan of Merger; References. Except as expressly amended by this Amendment, all of the terms, conditions, and other provisions of the Agreement are hereby ratified and confirmed and shall continue to be in full force and effect in accordance with their respective terms. No reference to this Amendment need be made in any instrument or document making reference to the Agreement, and any reference to the Agreement in any such instrument or document shall be deemed to refer to the Agreement as amended by this Amendment.

Section 4. Governing Law. This Amendment shall be governed by and construed in accordance with the laws of the State of Delaware, without giving effect to principles or rules of conflict of laws to the extent such principles or rules of law would require or permit the application of laws of another jurisdiction.

Section 5. Headings. The headings to the Sections, Schedules, Exhibits, and any sections or paragraphs of the Schedules or Exhibits are for convenience only and shall not affect the interpretation or construction of this Amendment.

Section 6. Counterparts. This Amendment may be executed in any number of counterparts, each of which shall be an original, but all of which together shall be deemed to constitute one instrument.

[Signature pages follow]

[Table of Contents](#)

IN WITNESS WHEREOF, CleanTech, Merger Sub, Nauticus, and the Stockholder Representative have caused this Amendment to be executed and delivered as of the date first written above.

	CLEANTECH ACQUISITION CORP. By: <u>/s/ Eli Spiro</u> Name: Eli Spiro Title Chief Executive Officer
	CLEANTECH MERGER SUB, INC. By: <u>/s/ Eli Spiro</u> Name: Eli Spiro Title Managing Member
	NAUTICUS ROBOTICS, INC. By: <u>/s/ Nicolaus A. Radford</u> Name: Nicolaus A. Radford Title President and Chief Executive Officer
	STOCKHOLDER REPRESENTATIVE By: <u>/s/ Nicolaus Radford</u> Name: Nicolaus Radford

[Signature Page to Amendment no. 1 to Agreement and Plan of Merger]

AMENDMENT NO. 2 TO AGREEMENT AND PLAN OF MERGER

This Amendment No. 2 to Agreement and Plan of Merger (this “**Amendment**”), dated as of June 6, 2022, is made and entered into by and among CleanTech Acquisition Corp. (“**CleanTech**”), CleanTech Merger Sub, Inc. (“**Merger Sub**”), Nauticus Robotics, Inc. (“**Nauticus**”), and Nicolaus Radford, solely in his capacity as the stockholder representative (the “**Stockholder Representative**”) pursuant to the designation in Section 11.16 of the Agreement (defined below).

WHEREAS, CleanTech, Merger Sub, Nauticus, and the Stockholder Representative are parties to that certain Agreement and Plan of Merger, dated as of December 16, 2021, as amended (the “**Agreement**”);

WHEREAS, pursuant to Section 11.10 of the Agreement, the Agreement may be amended by a written instrument duly executed in the same manner as the Agreement and which makes reference to the Agreement; and

WHEREAS, CleanTech, Merger Sub, Nauticus, and the Stockholder Representative desire to amend the Agreement as set forth in this Amendment.

NOW, THEREFORE, in consideration of the premises, and for other good and valuable consideration, the receipt and sufficiency of which are hereby acknowledged, the parties hereto hereby agree as follows:

Section 1. Amendment to Section 8.03. Section 8.03(c) of the Agreement is hereby amended and replaced in its entirety as follows:

“(c) Acquiror agrees to include provisions in the Proxy Statement and to take reasonable action related thereto with respect to (i) approval of the Merger (the “Transaction Proposal”), (ii) approval of the PubCo Charter (the “Amendment Proposal”), (iii) approval of the issuance of PubCo’s Common Stock in connection with the Transactions (including pursuant to the consummation of the Subscription Agreements) in accordance with this Agreement, in each case to the extent required by Nasdaq listing rules (the “Stock Issuance Proposal”), (iv) the adoption of the Acquiror Incentive Plan (the “Acquiror Incentive Plan Proposal”) and (v) approval of any other proposals reasonably necessary or appropriate to consummate the transaction contemplated hereby (the “Additional Proposal” and together with the Agreement Proposal, Merger Proposal, Amendment Proposal, Acquiror Incentive Plan Proposal and the Stock Issuance Proposal, the “Proposals”). The Acquiror Incentive Plan Proposal shall provide that an aggregate number of shares of PubCo’s Common Stock equal to 10% of the fully diluted outstanding shares of PubCo’s Common Stock immediately after the Closing shall be reserved for issuance pursuant to the Acquiror Incentive Plan, subject to annual 3% increases as provided therein. Without the prior written consent of the Company, the Proposals shall be the only matters (other than procedural matters) which Acquiror shall propose to be acted on by Acquiror’s stockholders at the Special Meeting.”

Section 2. Ratification of Agreement and Plan of Merger; References. Except as expressly amended by this Amendment, all of the terms, conditions, and other provisions of the Agreement are hereby ratified and confirmed and shall continue to be in full force and effect in accordance with their respective terms. No reference to this Amendment need be made in any instrument or document making reference to the Agreement, and any reference to the Agreement in any such instrument or document shall be deemed to refer to the Agreement as amended by this Amendment.

Section 3. Governing Law. This Amendment shall be governed by and construed in accordance with the laws of the State of Delaware, without giving effect to principles or rules of conflict of laws to the extent such principles or rules of law would require or permit the application of laws of another jurisdiction.

Section 4. Headings. The headings to the Sections, Schedules, Exhibits, and any sections or paragraphs of the Schedules or Exhibits are for convenience only and shall not affect the interpretation or construction of this Amendment.

Section 5. Counterparts. This Amendment may be executed in any number of counterparts, each of which shall be an original, but all of which together shall be deemed to constitute one instrument.

[Signature pages follow]

[Table of Contents](#)

IN WITNESS WHEREOF, CleanTech, Merger Sub, Nauticus, and the Stockholder Representative have caused this Amendment to be executed and delivered as of the date first written above.

	CLEANTECH ACQUISITION CORP. By: <u>/s/ Eli Spiro</u> Name: Eli Spiro Title Chief Executive Officer
	CLEANTECH MERGER SUB, INC. By: <u>/s/ Eli Spiro</u> Name: Eli Spiro Title Managing Member
	NAUTICUS ROBOTICS, INC. By: <u>/s/ Nicolaus A. Radford</u> Name: Nicolaus A. Radford Title President and Chief Executive Officer
	STOCKHOLDER REPRESENTATIVE By: <u>/s/ Nicolaus Radford</u> Name: Nicolaus Radford

**FORM OF SECOND AMENDED AND RESTATED CERTIFICATE OF INCORPORATION
OF
CLEANTECH ACQUISITION CORP.**

CleanTech Acquisition Corp. (the "Corporation"), a corporation organized and existing under the General Corporation Law of the State of Delaware (the "DGCL"), does hereby certify as follows:

1. The name of the Corporation is CleanTech Acquisition Corp. The Corporation was incorporated under the name CleanTech Acquisition Corp. by the filing of its original Certificate of Incorporation with the Secretary of State of the State of Delaware on June 18, 2020 (the "Original Certificate").

2. An Amended and Restated Certificate of Incorporation, which amended and restated the Original Certificate in its entirety, was filed with the Secretary of State of the State of Delaware on July 14, 2021 (as amended from time to time, the "Existing Certificate").

3. This Second Amended and Restated Certificate of Incorporation (the "Second Amended and Restated Certificate"), which amends and restates the Existing Certificate in its entirety, has been approved by the Board of Directors of the Corporation (the "Board of Directors") in accordance with Sections 242 and 245 of the DGCL and has been adopted by the stockholders of the Corporation at a meeting of the stockholders of the Corporation in accordance with the provisions of Section 211 of the DGCL.

4. The text of the Existing Certificate is hereby amended and restated by this Second Amended and Restated Certificate to read in its entirety as set forth in EXHIBIT A attached hereto.

5. This Second Amended and Restated Certificate shall become effective on the date of filing with the Secretary of State of the State of Delaware.

IN WITNESS WHEREOF, CleanTech Acquisition Corp. has caused this Second Amended and Restated Certificate to be signed by a duly authorized officer of the Corporation, on [•], 2022.

CLEANTECH ACQUISITION CORP.
By: _____
Name: Eli Spiro
Title: Chief Executive Officer

EXHIBIT A

ARTICLE I NAME

The name of the corporation is [Nauticus Robotics Inc.] (the “Corporation”).

ARTICLE II

REGISTERED OFFICE AND AGENT

The address of the Corporation’s registered office in the State of Delaware is [c/o Corporation Service Company, 251 Little Falls Drive, in the City of Wilmington, County of New Castle, State of Delaware, 19808, and the name of its registered agent at such address is Corporation Service Company].

ARTICLE III

PURPOSE

The purpose of the Corporation is to engage in any lawful act or activity for which corporations may be organized under the General Corporation Law of the State of Delaware (the “DGCL”) as it now exists or may hereafter be amended and supplemented.

ARTICLE IV

CAPITAL STOCK

The Corporation is authorized to issue two classes of stock to be designated, respectively, “Common Stock” and “Preferred Stock.” The total number of shares of capital stock which the Corporation shall have authority to issue is [*]. The total number of shares of Common Stock that the Corporation is authorized to issue is [*], having a par value of \$0.0001 per share, and the total number of shares of Preferred Stock that the Corporation is authorized to issue is [*], having a par value of \$0.0001 per share.

The designations and the powers, privileges and rights, and the qualifications, limitations or restrictions thereof in respect of each class of capital stock of the Corporation are as follows:

A. COMMON STOCK.

1. General. The voting, dividend, liquidation, and other rights and powers of the Common Stock are subject to and qualified by the rights, powers and preferences of any series of Preferred Stock as may be designated by the Board of Directors of the Corporation (the “Board of Directors”) and outstanding from time to time.

2. Voting. Except as otherwise provided herein or expressly required by law, each holder of Common Stock, as such, shall be entitled to vote on each matter submitted to a vote of stockholders and shall be entitled to one (1) vote for each share of Common Stock held of record by such holder as of the record date for determining stockholders entitled to vote on such matter. Except as otherwise required by law, holders of Common Stock, as such, shall not be entitled to vote on any amendment to this Second Amended and Restated Certificate (including any Certificate of Designation (as defined below)) that relates solely to the rights, powers, preferences (or the qualifications, limitations or restrictions thereof) or other terms of one or more outstanding series of Preferred Stock if the holders of such affected series are entitled, either separately or together with the holders of one or more other such series, to vote thereon pursuant to this Second Amended and Restated Certificate (including any Certificate of Designation) or pursuant to the DGCL.

Subject to the rights of any holders of any outstanding series of Preferred Stock, the number of authorized shares of Common Stock may be increased or decreased (but not below the number of shares thereof then outstanding) by the affirmative vote of the holders of a majority of the stock of the Corporation entitled to vote, irrespective of the provisions of Section 242(b)(2) of the DGCL.

3. Dividends. Subject to applicable law and the rights and preferences of any holders of any outstanding series of Preferred Stock, the holders of Common Stock, as such, shall be entitled to the payment of dividends on the Common Stock when, as and if declared by the Board of Directors in accordance with applicable law.

4. Liquidation. Subject to the rights and preferences of any holders of any shares of any outstanding series of Preferred Stock, in the event of any liquidation, dissolution or winding up of the Corporation, whether voluntary or involuntary, the funds and assets of the Corporation that may be legally distributed to the Corporation's stockholders shall be distributed among the holders of the then outstanding Common Stock *pro rata* in accordance with the number of shares of Common Stock held by each such holder.

B. PREFERRED STOCK

Shares of Preferred Stock may be issued from time to time in one or more series, each of such series to have such terms as stated or expressed herein and in the resolution or resolutions providing for the creation and issuance of such series adopted by the Board of Directors as hereinafter provided.

Authority is hereby expressly granted to the Board of Directors from time to time to issue the Preferred Stock in one or more series, and in connection with the creation of any such series, by adopting a resolution or resolutions providing for the issuance of the shares thereof and by filing a certificate of designation relating thereto in accordance with the DGCL (a "Certificate of Designation"), to determine and fix the number of shares of such series and such voting powers, full or limited, or no voting powers, and such designations, preferences and relative participating, optional or other special rights, and qualifications, limitations or restrictions thereof, including without limitation thereof, dividend rights, conversion rights, redemption privileges and liquidation preferences, and to increase or decrease (but not below the number of shares of such series then outstanding) the number of shares of any series as shall be stated and expressed in such resolutions, all to the fullest extent now or hereafter permitted by the DGCL. Without limiting the generality of the foregoing, the resolution or resolutions providing for the creation and issuance of any series of Preferred Stock may provide that such series shall be superior or rank equally or be junior to any other series of Preferred Stock to the extent permitted by law and this Second Amended and Restated Certificate (including any Certificate of Designation). Except as otherwise required by law, holders of any series of Preferred Stock shall be entitled only to such voting rights, if any, as shall expressly be granted thereto by this Second Amended and Restated Certificate (including any Certificate of Designation).

The number of authorized shares of Preferred Stock may be increased or decreased (but not below the number of shares thereof then outstanding) by the affirmative vote of the holders of a majority of the stock of the Corporation entitled to vote, irrespective of the provisions of Section 242(b)(2) of the DGCL.

ARTICLE V

BOARD OF DIRECTORS

For the management of the business and for the conduct of the affairs of the Corporation it is further provided that:

A. Subject to the special rights of the holders of one or more outstanding series of Preferred Stock to elect directors, the initial directors of the Corporation shall be classified with respect to the time for which they severally hold office into three classes, designated as Class I, Class II and Class III. The initial Class I directors shall serve for a term expiring at the first annual meeting of the stockholders following the date of this Second Amended and Restated Certificate; the initial Class II directors shall serve for a term expiring at the second annual meeting of the stockholders following the date of this Second Amended and Restated Certificate; and the initial Class III directors shall serve for a term expiring at the third annual meeting following the date of this Second Amended and Restated Certificate. At each annual meeting of the stockholders of the Corporation beginning with the first annual meeting of the stockholders following the date of this Second Amended and Restated Certificate, subject to the special rights of the holders of one or more outstanding series of Preferred Stock to elect directors, the successors of the class of directors whose term expires at that meeting shall be elected to hold office for a term expiring at the annual meeting of the stockholders held in the third year following the year of their election. Each director shall hold office until his or her successor is duly elected and qualified or until his or her earlier death, resignation, disqualification or removal. No decrease in the number of directors shall shorten the term of any incumbent director. The Board of Directors is authorized to assign members of the Board of Directors already in office to Class I, Class II and Class III.

B. Except as otherwise expressly provided by the DGCL or this Second Amended and Restated Certificate, the business and affairs of the Corporation shall be managed by or under the direction of the Board of Directors. The number of directors which shall constitute the whole Board of Directors shall be fixed exclusively by one or more resolutions adopted from time to time by the Board of Directors.

C. Subject to the special rights of the holders of one or more outstanding series of Preferred Stock to elect directors, the Board of Directors or any individual director may be removed from office at any time, but only for cause and only by the affirmative vote of the holders of at least two-thirds (66 and 2/3%) of the voting power of all of the then outstanding shares of voting stock of the Corporation entitled to vote at an election of directors.

D. Subject to the special rights of the holders of one or more outstanding series of Preferred Stock to elect directors, except as otherwise provided by law, any vacancies on the Board of Directors resulting from death, resignation, disqualification, retirement, removal or other causes and any newly created directorships resulting from any increase in the number of directors shall be filled exclusively by the affirmative vote of a majority of the directors then in office, even though less than a quorum, or by a sole remaining director (other than any directors elected by the separate vote of one or more outstanding series of Preferred Stock), and shall not be filled by the stockholders. Any director appointed in accordance with the preceding sentence shall hold office until the expiration of the term to which such director shall have been appointed or until his or her earlier death, resignation, retirement, disqualification, or removal.

E. Whenever the holders of any one or more series of Preferred Stock issued by the Corporation shall have the right, voting separately as a series or separately as a class with one or more such other series, to elect directors at an annual or special meeting of stockholders, the election, term of office, removal and other features of such directorships shall be governed by the terms of this Second Amended and Restated Certificate (including any Certificate of Designation). Notwithstanding anything to the contrary in this [Article V](#), the number of directors that may be elected by the holders of any such series of Preferred Stock shall be in addition to the number fixed pursuant to paragraph B of this [Article V](#), and the total number of directors constituting the whole Board of Directors shall be automatically adjusted accordingly. Except as otherwise provided in the Certificate of Designation(s) in respect of one or more series of Preferred Stock, whenever the holders of any series of Preferred Stock having such right to elect additional directors are divested of such right pursuant to the provisions of such Certificate of Designation(s), the terms of office of all such additional directors elected by the holders of such series of Preferred Stock, or elected to fill any vacancies resulting from the death, resignation, disqualification or removal of such additional directors, shall forthwith terminate (in which case each such director thereupon shall cease to be qualified as, and shall cease to be, a director) and the total authorized number of directors of the Corporation shall automatically be reduced accordingly.

F. In furtherance and not in limitation of the powers conferred by statute, the Board of Directors is expressly authorized to adopt, amend or repeal the Amended and Restated Bylaws of the Corporation (as amended and/or restated from time to time, the “Bylaws”). In addition to any vote of the holders of any class or series of stock of the Corporation required by applicable law or by this Second Amended and Restated Certificate (including any Certificate of Designation in respect of one or more series of Preferred Stock) or the Bylaws of the Corporation, the adoption, amendment or repeal of the Bylaws of the Corporation by the stockholders of the Corporation shall require the affirmative vote of the holders of at least two-thirds (66 and 2/3%) of the voting power of all of the then outstanding shares of voting stock of the Corporation entitled to vote generally in an election of directors.

G. The directors of the Corporation need not be elected by written ballot unless the Bylaws so provide.

ARTICLE VI

STOCKHOLDERS

A. Any action required or permitted to be taken by the stockholders of the Corporation must be effected at an annual or special meeting of the stockholders of the Corporation, and shall not be taken by written consent in lieu of a meeting. Notwithstanding the foregoing, any action required or permitted to be taken by the holders of any series of Preferred Stock, voting separately as a series or separately as a class with one or more other such series, may be taken without a meeting, without prior notice and without a vote, to the extent expressly so provided by the applicable Certificate of Designation relating to such series of Preferred Stock, if a consent or consents in writing, setting forth the action so taken, shall be signed by the holders of outstanding shares of the relevant series of Preferred Stock having not less than the minimum number of votes that would be necessary to authorize or take such action at a meeting at which all shares entitled to vote thereon were present and voted and shall be delivered to the Corporation in accordance with the applicable provisions of the DGCL.

B. Subject to the special rights of the holders of one or more series of Preferred Stock, special meetings of the stockholders of the Corporation may be called, for any purpose or purposes, at any time only by or at the direction of the Board of Directors, the Chairperson of the Board of Directors, the Chief Executive Officer or the President, and shall not be called by any other person or persons.

C. Advance notice of stockholder nominations for the election of directors and of other business proposed to be brought by stockholders before any meeting of the stockholders of the Corporation shall be given in the manner provided in the Bylaws of the Corporation.

ARTICLE VII

LIABILITY

No director of the Corporation shall have any personal liability to the Corporation or its stockholders for monetary damages for any breach of fiduciary duty as a director, except to the extent such exemption from liability or limitation thereof is not permitted under the DGCL as the same exists or hereafter may be amended. Any amendment, repeal or modification of this [Article VII](#), or the adoption of any provision of the Second Amended and Restated Certificate inconsistent with this [Article VII](#), shall not adversely affect any right or protection of a director of the Corporation with respect to any act or omission occurring prior to such amendment, repeal, modification or adoption. If the DGCL is amended after approval by the stockholders of this [Article VII](#) to authorize corporate action further eliminating or limiting the personal liability of directors, then the liability of a director of the Corporation shall be eliminated or limited to the fullest extent permitted by the DGCL as so amended.

ARTICLE VIII

INDEMNIFICATION

The Corporation shall have the power to provide rights to indemnification and advancement of expenses to its current and former officers, directors, employees and agents and to any person who is or was serving at the request of the Corporation as a director, officer, employee or agent of another corporation, partnership, joint venture, trust or other enterprise.

ARTICLE IX

AMENDMENTS

A. Notwithstanding anything contained in this Second Amended and Restated Certificate to the contrary, in addition to any vote required by applicable law, the following provisions in this Second Amended and Restated Certificate may be amended, altered, repealed or rescinded, in whole or in part, or any provision inconsistent therewith or herewith may be adopted, only by the affirmative vote of the holders of at least two-thirds (66 and 2/3%) of the total voting power of all the then outstanding shares of stock of the Corporation entitled to vote thereon, voting together as a single class: Part B of [Article IV](#), [Article V](#), [Article VI](#), [Article VII](#), [Article VIII](#), and this [Article IX](#).

B. If any provision or provisions of this Second Amended and Restated Certificate shall be held to be invalid, illegal or unenforceable as applied to any circumstance for any reason whatsoever: (i) the validity, legality and enforceability of such provisions in any other circumstance and of the remaining provisions of this Second Amended and Restated Certificate (including, without limitation, each portion of any paragraph of this Second Amended and Restated Certificate containing any such provision held to be invalid, illegal or unenforceable that is not itself held to be invalid, illegal or unenforceable) shall not, to the fullest extent permitted by applicable law, in any way be affected or impaired thereby and (ii) to the fullest extent permitted by applicable law, the provisions of this Second Amended and Restated Certificate (including, without limitation, each such portion of any paragraph of this Second Amended and Restated Certificate containing any such provision held to be invalid, illegal or unenforceable) shall be construed so as to permit the Corporation to protect its directors, officers, employees and agents from personal liability in respect of their good faith service to or for the benefit of the Corporation to the fullest extent permitted by law.

**FORM OF AMENDED AND RESTATED BYLAWS
OF
[NAUTICUS ROBOTICS INC.]**

TABLE OF CONTENTS

	Annex C Page No.
ARTICLE I STOCKHOLDERS	C-1
1.1 Place of Meetings	C-1
1.2 Annual Meeting	C-1
1.3 Special Meetings	C-1
1.4 Notice of Meetings	C-1
1.5 Voting List	C-1
1.6 Quorum	C-2
1.7 Adjournments	C-2
1.8 Voting and Proxies	C-2
1.9 Action at Meeting	C-2
1.10 Nomination of Directors	C-2
1.11 Notice of Business to be Brought Before a Meeting	C-5
1.12 Conduct of Meetings	C-7
ARTICLE II DIRECTORS	C-8
2.1 General Powers	C-8
2.2 Number, Election and Term	C-8
2.3 Chairperson of the Board; Vice Chairperson of the Board	C-8
2.4 Terms of Office	C-8
2.5 Quorum	C-8
2.6 Action at Meeting	C-8
2.7 Removal	C-8
2.8 Newly Created Directorships; Vacancies	C-8
2.9 Resignation	C-8
2.10 Regular Meetings	C-9
2.11 Special Meetings	C-9
2.12 Notice of Special Meetings	C-9
2.13 Meetings by Conference Communications Equipment	C-9
2.14 Action by Consent	C-9
2.15 Committees	C-9
2.16 Compensation of Directors	C-9
ARTICLE III OFFICERS	C-9
3.1 Titles	C-9
3.2 Election	C-9
3.3 Qualification	C-10
3.4 Tenure	C-10
3.5 Resignation and Removal	C-10
3.6 Vacancies	C-10
3.7 President; Chief Executive Officer	C-10
3.8 Vice Presidents	C-10
3.9 Secretary and Assistant Secretaries	C-10
3.10 Treasurer and Assistant Treasurers	C-10
3.11 Salaries	C-11
3.12 Delegation of Authority	C-11

	Annex C Page No.
ARTICLE IV CAPITAL STOCK	C-11
4.1 Stock Certificates; Uncertificated Shares	C-11
4.2 Transfers	C-11
4.3 Lost, Stolen or Destroyed Certificates	C-12
4.4 Record Date	C-12
4.5 Regulations	C-12
ARTICLE V GENERAL PROVISIONS	C-12
5.1 Fiscal Year	C-12
5.2 Corporate Seal	C-12
5.3 Waiver of Notice	C-12
5.4 Voting of Securities	C-12
5.5 Evidence of Authority	C-13
5.6 Certificate of Incorporation	C-13
5.7 Severability	C-13
5.8 Pronouns	C-13
5.9 Electronic Transmission	C-13
ARTICLE VI AMENDMENTS	C-13
ARTICLE VII INDEMNIFICATION AND ADVANCEMENT	C-13
7.1 Power to Indemnify in Actions, Suits or Proceedings other than Those by or in the Right of the Corporation	C-13
7.2 Power to Indemnify in Actions, Suits or Proceedings by or in the Right of the Corporation	C-13
7.3 Authorization of Indemnification	C-14
7.4 Good Faith Defined	C-14
7.5 Right of Claimant to Bring Suit	C-14
7.6 Expenses Payable in Advance	C-14
7.7 Nonexclusivity of Indemnification and Advancement of Expenses	C-15
7.8 Insurance	C-15
7.9 Certain Definitions	C-15
7.10 Survival of Indemnification and Advancement of Expenses	C-15
7.11 Limitation on Indemnification	C-15
7.12 Contract Rights	C-15

**ARTICLE I
STOCKHOLDERS**

1.1 Place of Meetings. All meetings of stockholders shall be held at such place, if any, as may be designated from time to time by the Board of Directors (the “Board”) of [Nauticus Robotics Inc.], (the “Corporation”), the Chairperson of the Board or the Chief Executive Officer or, if not so designated, at the principal office of the Corporation.

1.2 Annual Meeting. The annual meeting of stockholders for the election of directors to succeed those whose terms expire and for the transaction of such other business as may properly be brought before the meeting shall be held on a date and at a time designated by the Board, the Chairperson of the Board or the Chief Executive Officer. The Corporation may postpone, recess, reschedule or cancel any previously scheduled annual meeting of stockholders.

1.3 Special Meetings. Special meetings of stockholders for any purpose or purposes may be called at any time by only the Board, the Chairperson of the Board or the Chief Executive Officer, and may not be called by any other person or persons; *provided* that, prior to the Final Conversion Date (as defined in the Certificate of Incorporation), special meetings of stockholders for any purpose or purposes may also be called by or at the request of stockholders of the Corporation collectively holding shares of capital stock of the Corporation with voting power sufficient to provide the Requisite Stockholder Consent (as defined in the Certificate of Incorporation). Business transacted at any special meeting of stockholders shall be limited to matters relating to the purpose or purposes stated in the notice of meeting. The Corporation may postpone, reschedule or cancel any previously scheduled meeting of stockholders; *provided, however*, that with respect to any special meeting of stockholders of the Corporation previously scheduled at the request of the Requisite Stockholder Consent, the Corporation shall not postpone, reschedule or cancel any such special meeting without the prior written consent of the stockholders who comprised the Requisite Stockholder Consent.

1.4 Notice of Meetings. Except as otherwise provided by law, the Certificate of Incorporation or these Bylaws, notice of each meeting of stockholders, whether annual or special, shall be given not less than ten (10) nor more than sixty (60) days before the date of the meeting to each stockholder entitled to vote at such meeting as of the record date for determining the stockholders entitled to notice of the meeting. Without limiting the manner by which notice otherwise may be given to stockholders, any notice to stockholders given by the Corporation shall be effective if given by electronic transmission in accordance with the General Corporation Law of the State of Delaware (the “DGCL”). The notices of all meetings shall state the place, if any, date and time of the meeting, the means of remote communications, if any, by which stockholders and proxyholders may be deemed to be present in person and vote at such meeting, and the record date for determining the stockholders entitled to vote at the meeting (if such date is different from the record date for stockholders entitled to notice of the meeting). The notice of a special meeting shall state, in addition, the purpose or purposes for which the meeting is called. If notice is given by mail, such notice shall be deemed given when deposited in the United States mail, postage prepaid, directed to the stockholder at such stockholder’s address as it appears on the records of the Corporation. If notice is given by electronic transmission, such notice shall be deemed given at the time specified in Section 232 of the DGCL.

1.5 Voting List. The Corporation shall prepare, at least ten (10) days before every meeting of stockholders, a complete list of the stockholders entitled to vote at the meeting (provided, however, if the record date for determining the stockholders entitled to vote is less than ten (10) days before the date of the meeting, the list shall reflect the stockholders entitled to vote as of the tenth day before the meeting date), arranged in alphabetical order, and showing the address of each stockholder and the number of shares registered in the name of each stockholder; *provided*, that such list shall not be required to contain the electronic mail address or other electronic contact information of any stockholder. Such list shall be open to the examination of any stockholder, for any purpose germane to the meeting, for a period of at least ten (10) days prior to the meeting: (a) on a reasonably accessible electronic network, provided that the information required to gain access to such list is provided with the notice of the meeting, or (b) during ordinary business hours, at the principal place of business of the Corporation. If the meeting is to be held at a place, then the list shall also be produced and kept at the time and place of the meeting during the whole time thereof, and may be examined by any stockholder who is present. If the meeting is to be held solely by means of remote communication, then such list shall also be open to the examination of any stockholder during the whole time of the meeting on a reasonably accessible electronic network, and the information required to access such list shall be provided with the notice of the meeting. Except as otherwise provided by law, the stock ledger contemplated by this Section 1.5 shall be the only evidence as to who are the stockholders entitled to examine the list of stockholders required by this Section 1.5 or entitled to vote in person or by proxy at any meeting of stockholders.

Table of Contents

1.6 Quorum. Except as otherwise provided by law, the Certificate of Incorporation or these Bylaws, at each meeting of stockholders the holders of a majority in voting power of the shares of the capital stock of the Corporation issued and outstanding and entitled to vote at the meeting, present in person or represented by proxy, shall constitute a quorum for the transaction of business; provided, however, that where a separate vote by a class or classes or series of capital stock is required by law or the Certificate of Incorporation, the holders of a majority in voting power of the shares of such class or classes or series of the capital stock of the Corporation issued and outstanding and entitled to vote on such matter, present in person or represented by proxy, shall constitute a quorum entitled to take action with respect to the vote on such matter. A quorum, once established at a meeting, shall not be broken by the withdrawal of enough votes to leave less than a quorum.

1.7 Adjournments. Any meeting of stockholders may be adjourned from time to time to any other time and to the same or some other place at which a meeting of stockholders may be held under these Bylaws by the Board, the chairperson of the meeting or, if directed to be voted on by the chairperson of the meeting, by a majority of the votes cast by stockholders present or represented at the meeting and entitled to vote thereon, although less than a quorum. It shall not be necessary to notify any stockholder of any adjournment of thirty (30) days or less if the time and place of the adjourned meeting, and the means of remote communication, if any, by which stockholders and proxyholders may be deemed to be present in person and vote at such adjourned meeting, are announced at the meeting at which adjournment is taken, unless after the adjournment a new record date is fixed for determination of stockholders entitled to vote at the adjourned meeting (in which case the Board shall fix the same or an earlier date as the record date for determining stockholders entitled to notice of such adjourned meeting and shall give notice of the adjourned meeting to each stockholder of record as of such date). At the adjourned meeting, the Corporation may transact any business which might have been transacted at the original meeting.

1.8 Voting and Proxies. Each stockholder of record entitled to vote at a meeting of stockholders may vote in person or may authorize another person or persons to vote for such stockholder by proxy. Except as otherwise limited therein, proxies shall entitle the persons authorized thereby to vote at any adjournment of such meeting. Proxies shall be filed with the Secretary of the Corporation. No such proxy shall be voted upon after three years from its date, unless the proxy expressly provides for a longer period. A proxy may be irrevocable if it states that it is irrevocable and if, and only as long as, it is coupled with an interest sufficient in law to support an irrevocable power, regardless of whether the interest with which it is coupled is an interest in the stock itself or an interest in the Corporation generally. A stockholder may revoke any proxy which is not irrevocable by attending the meeting and voting in person or by filing an instrument in writing revoking the proxy or another duly executed proxy bearing a later date with the Secretary of the Corporation.

1.9 Action at Meeting. When a quorum is present at any meeting, any matter other than the election of directors to be voted upon by the stockholders at such meeting shall be decided by a majority of the votes cast by the holders of all of the shares of stock present in person or represented by proxy at the meeting and voting affirmatively or negatively on such matter (or if one or more class, classes or series of stock are entitled to vote as a separate class or series, then a majority of the votes cast by the holders of the shares of stock of such class, classes or series entitled to vote as a separate class or series present or represented by proxy at the meeting and voting affirmatively or negatively on such matter), except when a different or minimum vote is required by law, regulation applicable to the Corporation or its securities, the rules or regulations of any stock exchange applicable to the Corporation, the Certificate of Incorporation or these Bylaws, in which case such different or minimum vote shall be the required vote on such matter. When a quorum is present at any meeting, in any election by stockholders of directors other than in a contested election, directors shall be elected by the affirmative vote of a majority of the votes cast in favor or against the election of a nominee at a meeting of stockholders. In a contested election, (i) the directors shall be elected by a plurality of the votes cast at a meeting of stockholders by the holders of stock entitled to vote in such election, and (ii) stockholders shall not be permitted to vote against a nominee. An election shall be considered contested if, as of the tenth (10th) day preceding the date on which the Corporation first mails its notice of meeting for such meeting to the stockholders of the Corporation, there are more nominees for election than directorships on the Board to be filled by election at the meeting.

1.10 Nomination of Directors.

(A) Except for any directors entitled to be elected by the holders of preferred stock, at any meeting of stockholders, only persons who are nominated in accordance with the procedures in this Section 1.10 shall be eligible for election as directors. Nominations of persons for election to the Board at an annual meeting of stockholders or a special meeting

[Table of Contents](#)

of stockholders at which directors are to be elected pursuant to the Corporation's notice of meeting may be made (i) by or at the direction of the Board or any duly authorized committee thereof or (ii) by any stockholder of the Corporation who (x) timely complies with the notice procedures in Section 1.10(B), (y) is a stockholder of record on the date of the giving of such notice and on the record date for the determination of stockholders entitled to vote at such meeting and (z) is entitled to vote at such meeting and on such election.

(B) To be timely, a stockholder's notice must be received in writing by the Secretary at the principal executive offices of the Corporation as follows: (i) in the case of an election of directors at an annual meeting of stockholders, not less than ninety (90) days nor more than one hundred twenty (120) days prior to the first anniversary of the preceding year's annual meeting (which date of the preceding year's annual meeting shall, for purposes of Sections 1.10 and 1.11 hereof with respect to the Corporation's first annual meeting of stockholders following the [listing of its shares on a national securities exchange], be deemed to have occurred on _____, 2022¹); provided, however, that in the event that the date of the annual meeting is advanced by more than thirty (30) days, or delayed by more than seventy (70), from the first anniversary of the preceding year's annual meeting, a stockholder's notice must be so received not earlier than the 120th day prior to such annual meeting and not later than the close of business on the later of (A) the 90th day prior to such annual meeting and (B) the tenth day following the day on which public disclosure of the date of such annual meeting is first made; or (ii) in the case of an election of directors at a special meeting of stockholders, provided that directors are to be elected at such special meeting as set forth in the Corporation's notice of meeting and provided further that the nomination made by the stockholder is for one of the director positions that the notice of meeting states will be filled at such special meeting, not earlier than the 120th day prior to such special meeting and not later than the close of business on the later of (x) the 90th day prior to such special meeting and (y) the tenth day following the day on which public disclosure of the date of such special meeting for the election of directors is first made. The number of nominees a stockholder may nominate for election at a meeting (or in the case of a stockholder giving the notice on behalf of a beneficial owner, the number of nominees a stockholder may nominate for election at the meeting on behalf of such beneficial owner) shall not exceed the number of directors to be elected at such meeting. In no event shall the adjournment or postponement of a meeting (or the public disclosure thereof) commence a new time period (or extend any time period) for the giving of a stockholder's notice.

The stockholder's notice to the Secretary shall set forth: (A) as to each proposed nominee (1) such person's name, age, business address and, if known, residence address, (2) such person's principal occupation or employment, (3) the class(es) and series and number of shares of stock of the Corporation that are, directly or indirectly, owned, beneficially or of record, by such person, (4) a description of all direct and indirect compensation and other material monetary agreements, arrangements and understandings during the past three years, and any other material relationships, between or among (x) the stockholder, the beneficial owner, if any, on whose behalf the nomination is being made and the respective affiliates and associates of, or others acting in concert with, such stockholder and such beneficial owner, on the one hand, and (y) each proposed nominee, and his or her respective affiliates and associates, or others acting in concert with such nominee(s), on the other hand, including all information that would be required to be disclosed pursuant to Item 404 of Regulation S-K if the stockholder making the nomination and any beneficial owner on whose behalf the nomination is made or any affiliate or associate thereof or person acting in concert therewith were the "registrant" for purposes of such Item and the proposed nominee were a director or executive officer of such registrant, and (5) any other information concerning such person that must be disclosed as to nominees in proxy solicitations pursuant to Regulation 14A under the Securities Exchange Act of 1934, as amended (the "Exchange Act"); and (B) as to the stockholder giving the notice and the beneficial owner, if any, on whose behalf the nomination is being made (1) the name and address of such stockholder, as they appear on the corporation's books, and of such beneficial owner, (2) the class(es) and series and number of shares of stock of the corporation that are, directly or indirectly, owned, beneficially or of record, by such stockholder and such beneficial owner, (3) a description of any agreement, arrangement or understanding between or among such stockholder and/or such beneficial owner and each proposed nominee and any other person or persons (including their names) pursuant to which the nomination(s) are being made or who may participate in the solicitation of proxies in favor of electing such nominee(s), (4) a description of any agreement, arrangement or understanding (including any derivative or short positions, swaps, profit interests, options, warrants, convertible securities, stock appreciation or similar rights, hedging transactions, and borrowed or loaned shares) that has been entered into by, or on behalf of, such stockholder or such beneficial owner, the effect or intent of which is to mitigate loss to, manage risk or benefit of share price changes for, or increase or decrease the voting power of, such stockholder or such beneficial owner with respect to shares of stock of the Corporation, (5) any other

¹ Note to Draft: This provision will only be needed if SPAC does not have an annual meeting in 2022.

[Table of Contents](#)

information relating to such stockholder and such beneficial owner that would be required to be disclosed in a proxy statement or other filings required to be made in connection with solicitations of proxies for the election of directors in a contested election pursuant to Section 14 of the Exchange Act and the rules and regulations promulgated thereunder, (6) a representation that such stockholder is a holder of record of stock of the Corporation entitled to vote at such meeting and on such election and intends to appear in person or by proxy at the meeting to nominate the person(s) named in its notice and (7) a representation whether such stockholder and/or such beneficial owner intends or is part of a group which intends (x) to deliver a proxy statement and/or form of proxy to holders of at least the percentage of the Corporation's outstanding capital stock reasonably believed by such stockholder or such beneficial owner to be sufficient to elect the nominee (and such representation shall be included in any such proxy statement and form of proxy) and/or (y) otherwise to solicit proxies or votes from stockholders in support of such nomination (and such representation shall be included in any such solicitation materials). Not later than ten (10) days after the record date for determining the stockholders entitled to vote at the meeting, the information required by Items (A)(1)-(5) and (B)(1)-(5) of the prior sentence shall be supplemented by the stockholder giving the notice to provide updated information as of such record date. In addition, to be effective, the stockholder's notice must be accompanied by the written consent of the proposed nominee to serve as a director if elected and to being named in the Corporation's proxy statement and associated proxy card as a nominee of the stockholder. The Corporation may require any proposed nominee to furnish such other information as the Corporation may reasonably require to, among other things, determine the eligibility of such proposed nominee to serve as a director of the Corporation or whether such nominee would be independent under applicable Securities and Exchange Commission and stock exchange rules and the Corporation's publicly disclosed corporate governance guidelines, as applicable. A stockholder shall not have complied with this Section 1.10(B) if the stockholder (or beneficial owner, if any, on whose behalf the nomination is made) solicits or does not solicit, as the case may be, proxies or votes in support of such stockholder's nominee in contravention of the representations with respect thereto required by this Section 1.10.

(C) The chairperson of any meeting shall have the power and duty to determine whether a nomination was made in accordance with the provisions of this Section 1.10 (including whether the stockholder or beneficial owner, if any, on whose behalf the nomination is made solicited (or is part of a group which solicited) or did not so solicit, as the case may be, proxies in support of such stockholder's nominee in compliance with the representations with respect thereto required by this Section 1.10), and if the chairperson should determine that a nomination was not made in accordance with the provisions of this Section 1.10, the chairperson shall so declare to the meeting and such nomination shall not be brought before the meeting. Without limiting the foregoing, in advance of any meeting of stockholders, the Board shall also have the power to determine whether any nomination was made in accordance with the provisions of this Section 1.10 (including whether the stockholder or beneficial owner, if any, on whose behalf the nomination is made solicited (or is part of a group which solicited) or did not so solicit, as the case may be, proxies in support of such stockholder's nominee in compliance with the representations with respect thereto required by this Section 1.10).

(D) Except as otherwise required by law, nothing in this Section 1.10 shall obligate the Corporation or the Board to include in any proxy statement or other stockholder communication distributed on behalf of the Corporation or the Board information with respect to any nominee for director submitted by a stockholder.

(E) Notwithstanding the foregoing provisions of this Section 1.10, unless otherwise required by law, if the stockholder (or a qualified representative of the stockholder) does not appear at the meeting to present a nomination, such nomination shall not be brought before the meeting, notwithstanding that proxies in respect of such nominee may have been received by the Corporation. For purposes of this Article I, to be considered a "qualified representative" of the stockholder, a person must be authorized by a written instrument executed by such stockholder or an electronic transmission delivered by such stockholder to act for such stockholder as proxy at the meeting of stockholders and such person must produce such written instrument or electronic transmission, or a reliable reproduction of the written instrument or electronic transmission, at the meeting of stockholders.

(F) For purposes of this Article I, "public disclosure" shall include disclosure in a press release reported by the Dow Jones News Service, Associated Press or comparable national news service or in a document publicly filed by the corporation with the Securities and Exchange Commission pursuant to Section 13, 14 or 15(d) of the Exchange Act.

(G) Notwithstanding anything in this Section 1.10 to the contrary, in the event that the number of directors to be elected to the Board at any annual meeting is increased effective after the time period for which nominations would otherwise be due under Section 1.10(B) and there is no public disclosure by the Corporation naming the nominees for the additional directorships at least one hundred (100) days prior to the first anniversary of the preceding year's annual

[Table of Contents](#)

meeting, a stockholder's notice required by Section 1.10(B) with respect to nominations for such annual meeting shall also be considered timely, but only with respect to nominees for the additional directorships, if it shall be delivered to the Secretary at the principal executive offices of the Corporation not later than the close of business on the tenth day following the day on which such public disclosure is first made by the Corporation.

1.11 Notice of Business to be Brought Before a Meeting

(A) At an annual meeting of the stockholders, only such business shall be conducted as shall have been properly brought before the meeting. To be properly brought before an annual meeting, business (other than the nominations of persons for election to the Board) must constitute a proper matter for stockholder action and must be (i) specified in a notice of meeting given by or at the direction of the Board or any duly authorized committee thereof, (ii) if not specified in a notice of meeting, otherwise brought before the meeting by the Board or any duly authorized committee thereof or the Chairperson of the Board or (iii) otherwise properly brought before the meeting by a stockholder who (A) (1) was a stockholder of record of the Corporation both at the time of giving the notice provided for in this Section 1.11 and at the time of the meeting, (2) is entitled to vote at the meeting, and (3) has complied with this Section 1.11 in all applicable respects or (B) properly made such proposal in compliance with Rule 14a-8 under the Exchange Act. The foregoing clause (iii) shall be the exclusive means for a stockholder to propose business to be brought before an annual meeting of the stockholders. Notwithstanding anything herein to the contrary, unless otherwise required by law, if a stockholder seeking to bring business before an annual meeting pursuant to clause (iii) of this Section 1.11(A) (or a qualified representative of the stockholder) does not appear at the meeting to present the proposed business, such proposed business shall not be transacted, notwithstanding that proxies in respect of such proposed business may have been received by the Corporation.

(B) Without qualification, for business to be properly brought before an annual meeting by a stockholder, the stockholder must (i) provide Timely Notice (as defined below) thereof in writing and in proper form to the Secretary of the Corporation and (ii) provide any updates or supplements to such notice at the times and in the forms required by this Section 1.11. To be timely, a stockholder's notice must be delivered to, or mailed and received at, the principal executive offices of the Corporation not less than ninety (90) days nor more than one hundred twenty (120) days prior to the one-year anniversary of the preceding year's annual meeting; provided, however, that if the date of the annual meeting is more than thirty (30) days before or more than seventy (70) days after such anniversary date, notice by the stockholder to be timely must be so delivered, or mailed and received, not later than the 90th day prior to such annual meeting or, if later, the tenth day following the day on which public disclosure of the date of such annual meeting was first made (such notice within such time periods, "Timely Notice"). In no event shall any adjournment or postponement of an annual meeting or the announcement thereof commence a new time period (or extend any time period) for the giving of Timely Notice as described above.

(C) To be in proper form for purposes of this Section 1.11, a stockholder's notice to the Secretary shall set forth:

(i) As to each Proposing Person (as defined below), (A) the name and address of such Proposing Person (including, if applicable, the name and address that appear on the Corporation's books and records); and (B) the class(es) and series and number of shares of the Corporation that are, directly or indirectly, owned of record and beneficially owned (within the meaning of Rule 13d-3 under the Exchange Act) by such Proposing Person, except that such Proposing Person shall in all events be deemed to beneficially own any shares of any class or series of the Corporation as to which such Proposing Person has a right to acquire beneficial ownership at any time in the future (the disclosures to be made pursuant to the foregoing clauses (A) and (B) are referred to as "Stockholder Information");

(ii) As to each Proposing Person, (A) the full notional amount of any securities that, directly or indirectly, underlie any "derivative security" (as such term is defined in Rule 16a-1(c) under the Exchange Act) that constitutes a "call equivalent position" (as such term is defined in Rule 16a-1(b) under the Exchange Act) ("Synthetic Equity Position") and that is, directly or indirectly, held or maintained by such Proposing Person with respect to any shares of any class(es) or series of shares of the Corporation; provided that, for the purposes of the definition of "Synthetic Equity Position," the term "derivative security" shall also include any security or instrument that would not otherwise constitute a "derivative security" as a result of any feature that would make any conversion, exercise or similar right or privilege of such security or instrument becoming determinable only at some future date or upon the happening of a future occurrence, in which case the determination of the amount of securities into which such security or instrument would be convertible or exercisable shall be made assuming that such security or instrument is immediately convertible or exercisable at the time of such determination; and, provided, further, that any Proposing Person satisfying the requirements

of Rule 13d-1(b)(1) under the Exchange Act (other than a Proposing Person that so satisfies Rule 13d-1(b)(1) under the Exchange Act solely by reason of Rule 13d-1(b)(1)(ii)(E)) shall not be deemed to hold or maintain the notional amount of any securities that underlie a Synthetic Equity Position held by such Proposing Person as a hedge with respect to a bona fide derivatives trade or position of such Proposing Person arising in the ordinary course of such Proposing Person's business as a derivatives dealer, (B) any rights to dividends on the shares of any class or series of shares of the Corporation owned beneficially by such Proposing Person that are separated or separable from the underlying shares of the Corporation, (C) any material pending or threatened legal proceeding in which such Proposing Person is a party or material participant involving the Corporation or any of its officers or directors, or any affiliate of the Corporation, (D) any other material relationship between such Proposing Person, on the one hand, and the Corporation and any affiliate of the Corporation, on the other hand, (E) any direct or indirect material interest in any material contract or agreement of such Proposing Person with the Corporation or any affiliate of the Corporation (including, in any such case, any employment agreement, collective bargaining agreement or consulting agreement), (F) a representation that such stockholder is a holder of record of stock of the Corporation entitled to vote at such meeting and intends to appear in person or by proxy at the meeting to propose such business, (G) a representation that such Proposing Person intends or is part of a group which intends to deliver a proxy statement or form of proxy to holders of at least the percentage of the Corporation's outstanding capital stock required to approve or adopt the proposal or otherwise solicit proxies from stockholders in support of such proposal and (H) any other information relating to such Proposing Person that would be required to be disclosed in a proxy statement or other filing required to be made in connection with solicitations of proxies or consents by such Proposing Person in support of the business proposed to be brought before the meeting pursuant to Section 14(a) of the Exchange Act (the disclosures to be made pursuant to the foregoing clauses (A) through (G) are referred to as "Disclosable Interests"); provided, however, that Disclosable Interests shall not include any such disclosures with respect to the ordinary course business activities of any broker, dealer, commercial bank, trust company or other nominee who is a Proposing Person solely as a result of being the stockholder directed to prepare and submit the notice required by these Bylaws on behalf of a beneficial owner; and

(iii) As to each item of business that the stockholder proposes to bring before the annual meeting, (A) a brief description of the business desired to be brought before the annual meeting, the reasons for conducting such business at the annual meeting and any material interest in such business of each Proposing Person, (B) the text of the proposal or business (including the text of any resolutions proposed for consideration and in the event that such business includes a proposal to amend these Bylaws, the language of the proposed amendment), and (C) a reasonably detailed description of all agreements, arrangements and understandings (x) between or among any of the Proposing Persons or (y) between or among any Proposing Person and any other record or beneficial holder(s) of shares of capital stock of the Corporation or persons(s) who have a right to acquire beneficial ownership at any time in the future of the shares of any class or series of the Corporation (including their names) in connection with the proposal of such business by such stockholder; and (D) any other information relating to such item of business that would be required to be disclosed in a proxy statement or other filing required to be made in connection with solicitations of proxies in support of the business proposed to be brought before the meeting pursuant to Section 14(a) of the Exchange Act; provided, however, that the disclosures required by this paragraph (iii) shall not include any disclosures with respect to any broker, dealer, commercial bank, trust company or other nominee who is a Proposing Person solely as a result of being the stockholder directed to prepare and submit the notice required by these Bylaws on behalf of a beneficial owner.

For purposes of this Section 1.11, the term "Proposing Person" shall mean (i) the stockholder providing the notice of business proposed to be brought before an annual meeting, (ii) the beneficial owner or beneficial owners, if different, on whose behalf the notice of the business proposed to be brought before the annual meeting is made, and (iii) any participant (as defined in paragraphs (a)(ii)-(vi) of Instruction 3 to Item 4 of Schedule 14A) with such stockholder in such solicitation.

(D) A Proposing Person shall update and supplement its notice to the Corporation of its intent to propose business at an annual meeting, if necessary, so that the information provided or required to be provided in such notice pursuant to this Section 1.11 shall be true and correct as of the record date for stockholders entitled to vote at the meeting and as of the date that is ten (10) business days prior to the meeting or any adjournment or postponement thereof, and such update and supplement shall be delivered to, or mailed and received by, the Secretary at the principal executive offices of the Corporation not later than five (5) business days after the record date for stockholders entitled

[Table of Contents](#)

to vote at the meeting (in the case of the update and supplement required to be made as of such record date), and not later than eight (8) business days prior to the date for the meeting or, if practicable, any adjournment or postponement thereof (and, if not practicable, on the first practicable date prior to the date to which the meeting has been adjourned or postponed) (in the case of the update and supplement required to be made as of ten (10) business days prior to the meeting or any adjournment or postponement thereof). For the avoidance of doubt, the obligation to update and supplement as set forth in this paragraph or any other Section of these Bylaws shall not limit the Corporation's rights with respect to any deficiencies in any notice provided by a stockholder, extend any applicable deadlines hereunder or enable or be deemed to permit a stockholder who has previously submitted notice hereunder to amend or update any proposal or to submit any new proposal, including by changing or adding matters, business or resolutions proposed to be brought before a meeting of the stockholders.

(E) Notwithstanding anything in these Bylaws to the contrary, no business shall be conducted at an annual meeting that is not properly brought before the meeting in accordance with this Section 1.11. The chairperson of the meeting shall have the power and duty to determine whether any proposed business was brought in accordance with the provisions of this Section 1.11, and if the chairperson should determine that the business was not properly brought before the meeting in accordance with this Section 1.11, the chairperson shall so declare to the meeting and any such business not properly brought before the meeting shall not be transacted. Without limiting the foregoing, in advance of any meeting of stockholders, the Board shall also have the power to determine whether any proposed business was made in accordance with the provisions of this Section 1.11.

(F) This Section 1.11 is expressly intended to apply to any business proposed to be brought before an annual meeting of stockholders other than any proposal made in accordance with Rule 14a-8 under the Exchange Act and included in the Corporation's proxy statement. In addition to the requirements of this Section 1.11 with respect to any business proposed to be brought before an annual meeting of stockholders, each Proposing Person shall comply with all applicable requirements of the Exchange Act with respect to any such business. Nothing in this Section 1.11 shall be deemed to affect the rights of stockholders to request inclusion of proposals in the Corporation's proxy statement pursuant to Rule 14a-8 under the Exchange Act.

1.12 Conduct of Meetings.

(A) Meetings of stockholders shall be presided over by the Chairperson of the Board, if any, or in the Chairperson's absence by the Vice Chairperson of the Board, if any, or in the Vice Chairperson's absence by the Chief Executive Officer, or in the Chief Executive Officer's absence, by the President, or in the President's absence by a Vice President, or in the absence of all of the foregoing persons by a chairperson designated by the Board. The Secretary shall act as secretary of the meeting, but in the Secretary's absence the chairperson of the meeting may appoint any person to act as secretary of the meeting.

(B) The Board may adopt by resolution such rules, regulations and procedures for the conduct of any meeting of stockholders of the Corporation as it shall deem appropriate including, without limitation, such guidelines and procedures as it may deem appropriate regarding the participation by means of remote communication of stockholders and proxyholders not physically present at a meeting. Except to the extent inconsistent with such rules, regulations and procedures as adopted by the Board, the chairperson of any meeting of stockholders shall have the right and authority to convene and (for any or no reason) to recess and/or adjourn the meeting, to prescribe such rules, regulations and procedures and to do all such acts as, in the judgment of such chairperson, are appropriate for the proper conduct of the meeting. Such rules, regulations or procedures, whether adopted by the Board or prescribed by the chairperson of the meeting, may include, without limitation, the following: (i) the establishment of an agenda or order of business for the meeting; (ii) rules and procedures for maintaining order at the meeting and the safety of those present; (iii) limitations on attendance at or participation in the meeting to stockholders of record of the Corporation, their duly authorized and constituted proxies or such other persons as shall be determined; (iv) restrictions on entry to the meeting after the time fixed for the commencement thereof; and (v) limitations on the time allotted to questions or comments by participants. Unless and to the extent determined by the Board or the chairperson of the meeting, meetings of stockholders shall not be required to be held in accordance with the rules of parliamentary procedure.

(C) The chairperson of the meeting shall announce at the meeting when the polls for each matter to be voted upon at the meeting will be opened and closed. After the polls close, no ballots, proxies or votes or any revocations or changes thereto may be accepted.

(D) In advance of any meeting of stockholders, the Board, the Chairperson of the Board or the Chief Executive Officer shall appoint one or more inspectors of election to act at the meeting and make a written report thereof. One or more other persons may be designated as alternate inspectors to replace any inspector who fails to act. If no inspector or alternate is present, ready and willing to act at a meeting of stockholders, the chairperson of the meeting shall appoint one or more inspectors to act at the meeting. Unless otherwise required by law, inspectors may be officers, employees or agents of the Corporation. Each inspector, before entering upon the discharge of such inspector's duties, shall take and sign an oath faithfully to execute the duties of inspector with strict impartiality and according to the best of such inspector's ability. The inspector shall have the duties prescribed by law and, when the vote is completed, shall certify their determination of the result of the vote taken and of such other facts as may be required by law. Every vote taken by ballots shall be counted by a duly appointed inspector or duly appointed inspectors.

ARTICLE II DIRECTORS

2.1 General Powers. The business and affairs of the Corporation shall be managed by or under the direction of the Board, who may exercise all of the powers of the Corporation except as otherwise provided by law or the Certificate of Incorporation.

2.2 Number, Election and Term. The total number of directors constituting the Board shall be as fixed in, or in the manner provided by, the Certificate of Incorporation. Election of directors need not be by written ballot. The term of office of each director shall be as specified in the Certificate of Incorporation.

2.3 Chairperson of the Board; Vice Chairperson of the Board. The Board may appoint from its members a Chairperson of the Board and a Vice Chairperson of the Board, neither of whom need be an employee or officer of the Corporation. If the Board appoints a Chairperson of the Board, such Chairperson shall perform such duties and possess such powers as are assigned by the Board and, if the Chairperson of the Board is also designated as the Corporation's Chief Executive Officer, shall have the powers and duties of the Chief Executive Officer prescribed in Section 3.7 of these Bylaws. If the Board appoints a Vice Chairperson of the Board, such Vice Chairperson shall perform such duties and possess such powers as are assigned by the Board. Unless otherwise provided by the Board, the Chairperson of the Board or, in the Chairperson's absence, the Vice Chairperson of the Board, if any, shall preside at all meetings of the Board.

2.4 Terms of Office. Directors shall be elected for such terms and in the manner provided by the Certificate of Incorporation and applicable law. The term of each director shall continue until the election and qualification of his or her successor and be subject to his or her earlier death, resignation, disqualification or removal. For the avoidance of doubt, no decrease in the number of directors constituting the Board shall shorten the term of any incumbent director.

2.5 Quorum. The greater of (a) a majority of the directors at any time in office and (b) one-third of the number of directors established by the Board pursuant to Section 2.2 of these Bylaws shall constitute a quorum of the Board. If at any meeting of the Board there shall be less than a quorum, a majority of the directors present may adjourn the meeting from time to time without further notice other than announcement at the meeting, until a quorum shall be present.

2.6 Action at Meeting. Every act or decision done or made by a majority of the directors present at a meeting duly held at which a quorum is present shall be regarded as the act of the Board, unless a greater number is required by law, the Certificate of Incorporation or these Bylaws.

2.7 Removal. Directors of the Corporation may only be removed in the manner specified by the Certificate of Incorporation.

2.8 Newly Created Directorships; Vacancies. Any newly created directorship or vacancy on the Board, however occurring, shall be filled in accordance with the Certificate of Incorporation and applicable law.

2.9 Resignation. Any director may resign by delivering a resignation in writing or by electronic transmission to the Corporation. Such resignation shall be effective upon delivery unless it is specified to be effective at some later time or upon the happening of some later event.

[Table of Contents](#)

2.10 Regular Meetings. Regular meetings of the Board may be held without notice at such time and place as shall be determined from time to time by the Board; provided that any director who is absent when such a determination is made shall be given notice of the determination. A regular meeting of the Board may be held without notice immediately after and at the same place as the annual meeting of stockholders.

2.11 Special Meetings. Special meetings of the Board may be called by the Chairperson of the Board, the Chief Executive Officer, the affirmative vote of a majority of the directors then in office, or by one director in the event that there is only a single director in office.

2.12 Notice of Special Meetings. Notice of the date, place and time of any special meeting of the Board shall be given to each director (a) in person or by telephone at least twenty-four (24) hours in advance of the meeting, (b) by sending written notice by reputable overnight courier, telecopy, facsimile, electronic mail or other means of electronic transmission, or delivering written notice by hand, to such director's last known business, home or means of electronic transmission address at least twenty-four (24) hours in advance of the meeting, or (c) by sending written notice by first-class mail to such director's last known business or home address at least seventy-two (72) hours in advance of the meeting. Such notice may be given by the Secretary or by the Chairperson of the Board, the Chief Executive Officer or one of the directors calling the meeting. A notice or waiver of notice of a meeting of the Board need not specify the purposes of the meeting.

2.13 Meetings by Conference Communications Equipment. Directors may participate in meetings of the Board or any committee thereof by means of conference telephone or other communications equipment by means of which all persons participating in the meeting can hear each other, and participation by such means shall constitute presence in person at such meeting.

2.14 Action by Consent. Any action required or permitted to be taken at any meeting of the Board or of any committee thereof may be taken without a meeting, if all members of the Board or committee, as the case may be, consent to the action in writing or by electronic transmission.

2.15 Committees. The Board may designate one or more committees, each committee to consist of one or more of the directors of the Corporation with such lawfully delegable powers and duties as the Board thereby confers, to serve at the pleasure of the Board. The Board may designate one or more directors as alternate members of any committee, who may replace any absent or disqualified member at any meeting of the committee. In the absence or disqualification of a member of a committee, the member or members of the committee present at any meeting and not disqualified from voting, whether or not such member or members constitute a quorum, may unanimously appoint another member of the Board to act at the meeting in the place of any such absent or disqualified member. Any such committee, to the extent provided in the resolution of the Board and subject to the provisions of law, shall have and may exercise all the powers and authority of the Board in the management of the business and affairs of the Corporation and may authorize the seal of the Corporation to be affixed to all papers which may require it. Each such committee shall keep minutes and make such reports as the Board may from time to time request. Except as otherwise provided in the Certificate of Incorporation, these Bylaws, or the resolution of the Board designating the committee, a committee may create one or more subcommittees, each subcommittee to consist of one or more members of the committee, and delegate to a subcommittee any or all of the powers and authority of the committee.

2.16 Compensation of Directors. Directors may be paid such compensation for their services and such reimbursement for expenses of attendance at meetings as the Board may from time to time determine. No such payment shall preclude any director from serving the Corporation or any of its parent or subsidiary entities in any other capacity and receiving compensation for such service.

ARTICLE III OFFICERS

3.1 Titles. The officers of the Corporation may consist of a Chief Executive Officer, a President, a Chief Financial Officer, a Treasurer and a Secretary and such other officers with such other titles as the Board shall from time to time determine. The Board may appoint such other officers, including one or more Vice Presidents and one or more Assistant Treasurers or Assistant Secretaries, as it may deem appropriate from time to time.

3.2 Election. The Chief Executive Officer, President, Treasurer and Secretary shall be elected annually by the Board at its first meeting following the annual meeting of stockholders. Other officers may be appointed by the Board at such meeting or at any other meeting.

[Table of Contents](#)

3.3 Qualification. No officer need be a stockholder. Any two or more offices may be held by the same person.

3.4 Tenure. Except as otherwise provided by law, by the Certificate of Incorporation or by these Bylaws, each officer shall hold office until such officer's successor is duly elected and qualified, unless a different term is specified in the resolution electing or appointing such officer, or until such officer's earlier death, resignation, disqualification or removal.

3.5 Resignation and Removal. Any officer may resign by delivering a resignation in writing or by electronic transmission to the Corporation. Such resignation shall be effective upon receipt unless it is specified to be effective at some later time or upon the happening of some later event. Any officer may be removed at any time, with or without cause, by the affirmative vote of a majority of the directors then in office. Except as the Board may otherwise determine, no officer who resigns or is removed shall have any right to any compensation as an officer for any period following such officer's resignation or removal, or any right to damages on account of such removal, whether such officer's compensation be by the month or by the year or otherwise, unless such compensation is expressly provided for in a duly authorized written agreement with the Corporation.

3.6 Vacancies. The Board may fill any vacancy occurring in any office. Each such successor shall hold office for the unexpired term of such officer's predecessor and until a successor is duly elected and qualified, or until such officer's earlier death, resignation, disqualification or removal.

3.7 President; Chief Executive Officer. Unless the Board has designated another person as the Corporation's Chief Executive Officer, the President shall be the Chief Executive Officer of the Corporation. The Chief Executive Officer shall have general charge and supervision of the business of the Corporation subject to the direction of the Board, and shall perform all duties and have all powers that are commonly incident to the office of chief executive or that are delegated to such officer by the Board. The President shall perform such other duties and shall have such other powers as the Board or the Chief Executive Officer (if the President is not the Chief Executive Officer) may from time to time prescribe. In the event of the absence, inability or refusal to act of the Chief Executive Officer or the President (if the President is not the Chief Executive Officer), the Vice President (or if there shall be more than one, the Vice Presidents in the order determined by the Board) shall perform the duties of the Chief Executive Officer and when so performing such duties shall have all the powers of and be subject to all the restrictions upon the Chief Executive Officer.

3.8 Vice Presidents. Each Vice President shall perform such duties and possess such powers as the Board or the Chief Executive Officer may from time to time prescribe. The Board may assign to any Vice President the title of Executive Vice President, Senior Vice President or any other title selected by the Board.

3.9 Secretary and Assistant Secretaries. The Secretary shall perform such duties and shall have such powers as the Board or the Chief Executive Officer may from time to time prescribe. In addition, the Secretary shall perform such duties and have such powers as are incident to the office of the secretary, including without limitation the duty and power to give notices of all meetings of stockholders and special meetings of the Board, to attend all meetings of stockholders and the Board and keep a record of the proceedings, to maintain a stock ledger and prepare lists of stockholders and their addresses as required, to be custodian of corporate records and the corporate seal and to affix and attest to the same on documents.

Any Assistant Secretary shall perform such duties and possess such powers as the Board, the Chief Executive Officer or the Secretary may from time to time prescribe. In the event of the absence, inability or refusal to act of the Secretary, the Assistant Secretary (or if there shall be more than one, the Assistant Secretaries in the order determined by the Board) shall perform the duties and exercise the powers of the Secretary.

In the absence of the Secretary or any Assistant Secretary at any meeting of stockholders or directors, the chairperson of the meeting shall designate a temporary secretary to keep a record of the meeting.

3.10 Treasurer and Assistant Treasurers. The Treasurer shall perform such duties and shall have such powers as may from time to time be assigned by the Board or the Chief Executive Officer. In addition, the Treasurer shall perform such duties and have such powers as are incident to the office of treasurer, including without limitation the duty and power to keep and be responsible for all funds and securities of the Corporation, to deposit funds of the Corporation in depositories selected in accordance with these Bylaws, to disburse such funds as ordered by the Board, to make proper accounts of such funds, and to render as required by the Board statements of all such transactions and of the financial condition of the Corporation.

The Assistant Treasurers shall perform such duties and possess such powers as the Board, the Chief Executive Officer or the Treasurer may from time to time prescribe. In the event of the absence, inability or refusal to act of the Treasurer, the Assistant Treasurer (or if there shall be more than one, the Assistant Treasurers in the order determined by the Board) shall perform the duties and exercise the powers of the Treasurer.

3.11 Salaries. Officers of the Corporation shall be entitled to such salaries, compensation or reimbursement as shall be fixed or allowed from time to time by the Board.

3.12 Delegation of Authority. Subject to these Bylaws and any contrary action by the Board, each officer of the Corporation shall, have in addition to the duties and powers specifically set forth in these Bylaws, such duties and powers as are customarily incident to his or her office, and such duties and powers as may be designated from time to time by the Board. In addition, the Board may from time to time delegate the powers or duties of any officer to any other officer or agent, notwithstanding any provision hereof.

ARTICLE IV CAPITAL STOCK

4.1 Stock Certificates; Uncertificated Shares. The shares of the Corporation shall be represented by certificates, provided that the Board may provide by resolution or resolutions that some or all of any or all classes or series of the Corporation's stock shall be uncertificated shares. Any such resolution shall not apply to shares represented by a certificate until such certificate is surrendered to the Corporation. Every holder of stock of the Corporation represented by certificates shall be entitled to have a certificate, in such form as may be prescribed by law and by the Board, representing the number of shares held by such holder registered in certificate form. Each such certificate shall be signed in a manner that complies with Section 158 of the DGCL, and each officer appointed pursuant to Article III shall be an authorized officer for this purpose.

Each certificate for shares of stock which are subject to any restriction on transfer pursuant to the Certificate of Incorporation, these Bylaws, applicable securities laws or any agreement among any number of stockholders or among such holders and the Corporation shall have conspicuously noted on the face or back of the certificate either the full text of the restriction or a statement of the existence of such restriction.

If the Corporation shall be authorized to issue more than one class of stock or more than one series of any class, the powers, designations, preferences and relative participating, optional or other special rights of each class of stock or series thereof and the qualifications, limitations or restrictions of such preferences and/or rights shall be set forth in full or summarized on the face or back of each certificate representing shares of such class or series of stock, provided that in lieu of the foregoing requirements there may be set forth on the face or back of each certificate representing shares of such class or series of stock a statement that the Corporation will furnish without charge to each stockholder who so requests the powers, designations, preferences and relative, participating, optional or other special rights of each class of stock or series thereof and the qualifications, limitations or restrictions of such preferences and/or rights.

Within a reasonable time after the issuance or transfer of uncertificated shares, the registered owner thereof shall be given a notice, in writing or by electronic transmission, containing the information required to be set forth or stated on certificates pursuant to Sections 151, 156, 202(a) or 218(a) of the DGCL or, with respect to Section 151 of the DGCL, a statement that the Corporation will furnish without charge to each stockholder who so requests the powers, designations, preferences and relative participating, optional or other special rights of each class of stock or series thereof and the qualifications, limitations or restrictions of such preferences and/or rights.

4.2 Transfers. Shares of stock of the Corporation shall be transferable in the manner prescribed by law, the Certificate of Incorporation and in these Bylaws. Transfers of shares of stock of the Corporation shall be made only on the books of the Corporation or by transfer agents designated to transfer shares of stock of the Corporation. Subject to applicable law, shares of stock represented by certificates shall be transferred only on the books of the Corporation by the surrender to the Corporation or its transfer agent of the certificate representing such shares properly endorsed or accompanied by a written assignment or power of attorney properly executed, and with such proof of authority or the authenticity of signature as the Corporation or its transfer agent may reasonably require. Except as may be otherwise required by law, by the Certificate of Incorporation or by these Bylaws, the Corporation shall be entitled to treat the record holder of stock as shown on its books as the owner of such stock for all purposes, including the payment of

[Table of Contents](#)

dividends and the right to vote with respect to such stock, regardless of any transfer, pledge or other disposition of such stock until the shares have been transferred on the books of the Corporation in accordance with the requirements of these Bylaws.

4.3 Lost, Stolen or Destroyed Certificates. The Corporation may issue a new certificate or uncertificated shares in place of any previously issued certificate alleged to have been lost, stolen or destroyed, upon such terms and conditions as the Board may prescribe, including the presentation of reasonable evidence of such loss, theft or destruction and the giving of such indemnity and posting of such bond sufficient to indemnify the Corporation against any claim that may be made against it on account of the alleged loss, theft or destruction of any such certificate or the issuance of such new certificate or uncertificated shares.

4.4 Record Date. The Board may fix in advance a date as a record date for the determination of the stockholders entitled to notice of any meeting of stockholders, or entitled to receive payment of any dividend or other distribution or allotment of any rights in respect of any change, conversion or exchange of stock, or for the purpose of any other lawful action. Such record date shall not precede the date on which the resolution fixing the record date is adopted, and such record date shall not be more than sixty (60) nor less than ten (10) days before the date of such meeting, nor more than sixty (60) days prior to any other action to which such record date relates. If the Board so fixes a record date for determining the stockholders entitled to notice of any meeting of stockholders, such date shall also be the record date for determining the stockholders entitled to vote at such meeting unless the Board determines, at the time it fixes such record date, that a later date on or before the date of the meeting shall be the date for making such determination.

If no record date is fixed, the record date for determining stockholders entitled to notice of or to vote at a meeting of stockholders shall be at the close of business on the day before the day on which notice is given, or, if notice is waived, at the close of business on the day before the day on which the meeting is held. If no record date is fixed, the record date for determining stockholders for any other purpose shall be at the close of business on the day on which the Board adopts the resolution relating to such purpose.

A determination of stockholders of record entitled to notice of or to vote at a meeting of stockholders shall apply to any adjournment of the meeting; provided, however, that the Board may fix a new record date for determination of stockholders entitled to vote at the adjourned meeting, and in such case shall also fix as the record date for stockholders entitled to notice of such adjourned meeting the same or an earlier date as that fixed for determination of stockholders entitled to vote in accordance herewith at the adjourned meeting.

4.5 Regulations. The issue, conversion and registration of shares of stock of the Corporation shall be governed by such other regulations as the Board may establish.

**ARTICLE V
GENERAL PROVISIONS**

5.1 Fiscal Year. Except as from time to time otherwise designated by the Board, the fiscal year of the Corporation shall begin on the first day of January of each year and end on the last day of December in each year.

5.2 Corporate Seal. The corporate seal shall be in such form as shall be approved by the Board.

5.3 Waiver of Notice. Whenever notice is required to be given by law, by the Certificate of Incorporation or by these Bylaws, a written waiver signed by the person entitled to notice, or a waiver by electronic transmission by the person entitled to notice, whether before, at or after the time of the event for which notice is to be given, shall be deemed equivalent to notice required to be given to such person. Neither the business nor the purpose of any meeting need be specified in any such waiver. Attendance of a person at a meeting shall constitute a waiver of notice of such meeting, except when the person attends a meeting for the express purpose of objecting at the beginning of the meeting, to the transaction of any business because the meeting is not lawfully called or convened.

5.4 Voting of Securities. Except as the Board may otherwise designate, the Chief Executive Officer, the President, the Chief Financial Officer or the Treasurer may waive notice, vote, consent, or appoint any person or persons to waive notice, vote or consent, on behalf of the Corporation, and act as, or appoint any person or persons to act as, proxy or attorney-in-fact for the Corporation (with or without power of substitution and re-substitution), with respect to the securities of any other entity which may be held by the Corporation.

[Table of Contents](#)

5.5 Evidence of Authority. A certificate by the Secretary, or an Assistant Secretary, or a temporary Secretary, as to any action taken by the stockholders, directors, a committee or any officer or representative of the Corporation shall as to all persons who rely on the certificate in good faith be conclusive evidence of such action.

5.6 Certificate of Incorporation. All references in these Bylaws to the Certificate of Incorporation shall be deemed to refer to the Certificate of Incorporation of the Corporation, as amended and/or restated and in effect from time to time, including any certificate of designation relating to any outstanding series of preferred stock.

5.7 Severability. Any determination that any provision of these Bylaws is for any reason inapplicable, illegal or ineffective shall not affect or invalidate any other provision of these Bylaws.

5.8 Pronouns. All pronouns used in these Bylaws shall be deemed to refer to the masculine, feminine or neuter, singular or plural, as the identity of the person or persons may require.

5.9 Electronic Transmission. For purposes of these Bylaws, "electronic transmission" means any form of communication, not directly involving the physical transmission of paper, that creates a record that may be retained, retrieved, and reviewed by a recipient thereof, and that may be directly reproduced in paper form by such a recipient through an automated process.

**ARTICLE VI
AMENDMENTS**

These Bylaws may be altered, amended or repealed, in whole or in part, or new Bylaws may be adopted by the Board or by the stockholders as expressly provided in the Certificate of Incorporation.

**ARTICLE VII
INDEMNIFICATION AND ADVANCEMENT**

7.1 Power to Indemnify in Actions, Suits or Proceedings other than Those by or in the Right of the Corporation. Subject to Section 7.3, the Corporation shall indemnify any person who was or is a party or is threatened to be made a party to any threatened, pending or completed action, suit or proceeding, whether civil, criminal, administrative or investigative (other than an action by or in the right of the Corporation) by reason of the fact that such person is or was a director or officer of the Corporation, or, while a director or officer of the Corporation, is or was serving at the request of the Corporation as a director, officer, employee or agent of another corporation, partnership, joint venture, trust, employee benefit plan or other enterprise, against expenses (including attorneys' fees), judgments, fines and amounts paid in settlement actually and reasonably incurred by such person in connection with such action, suit or proceeding if such person acted in good faith and in a manner such person reasonably believed to be in or not opposed to the best interests of the Corporation, and, with respect to any criminal action or proceeding, had no reasonable cause to believe such person's conduct was unlawful. The termination of any action, suit or proceeding by judgment, order, settlement, conviction, or upon a plea of nolo contendere or its equivalent, shall not, of itself, create a presumption that the person did not act in good faith and in a manner which such person reasonably believed to be in or not opposed to the best interests of the Corporation, and, with respect to any criminal action or proceeding, had reasonable cause to believe that such person's conduct was unlawful.

7.2 Power to Indemnify in Actions, Suits or Proceedings by or in the Right of the Corporation. Subject to Section 7.3, the Corporation shall indemnify any person who was or is a party or is threatened to be made a party to any threatened, pending or completed action or suit by or in the right of the Corporation to procure a judgment in its favor by reason of the fact that such person is or was a director or officer of the Corporation, or, while a director or officer of the Corporation, is or was serving at the request of the Corporation as a director, officer, employee or agent of another corporation, partnership, joint venture, trust, employee benefit plan or other enterprise against expenses (including attorneys' fees) actually and reasonably incurred by such person in connection with the defense or settlement of such action or suit if such person acted in good faith and in a manner such person reasonably believed to be in or not opposed to the best interests of the Corporation; except that no indemnification shall be made in respect of any claim, issue or matter as to which such person shall have been adjudged to be liable to the Corporation unless and only to the extent that the Court of Chancery or the court in which such action or suit was brought shall determine upon application that, despite the adjudication of liability but in view of all the circumstances of the case, such person is fairly and reasonably entitled to indemnity by the Corporation for such expenses which the Court of Chancery or such other court shall deem proper.

7.3 Authorization of Indemnification. Any indemnification under this Article VII (unless ordered by a court) shall be made by the Corporation only as authorized in the specific case upon a determination that indemnification of the director or officer is proper in the circumstances because such person has met the applicable standard of conduct set forth in Section 7.1 or Section 7.2, as the case may be. Such determination shall be made, with respect to a person who is a director or officer at the time of such determination, (i) by a majority vote of the directors who are not parties to such action, suit or proceeding, even though less than a quorum, or (ii) by a committee of such directors designated by a majority vote of such directors, even though less than a quorum, or (iii) if there are no such directors, or if such directors so direct, by independent legal counsel in a written opinion or (iv) by the stockholders. Such determination shall be made, with respect to former directors and officers, by any person or persons having the authority to act on the matter on behalf of the Corporation. To the extent, however, that a present or former director or officer of the Corporation has been successful on the merits or otherwise in defense of any action, suit or proceeding set forth in Section 7.1 or Section 7.2 or in defense of any claim, issue or matter therein, such person shall be indemnified against expenses (including attorneys' fees) actually and reasonably incurred by such person in connection therewith, without the necessity of authorization in the specific case.

7.4 Good Faith Defined. For purposes of any determination under Section 7.3, a person shall, to the fullest extent permitted by law, be deemed to have acted in good faith and in a manner such person reasonably believed to be in or not opposed to the best interests of the Corporation, or, with respect to any criminal action or proceeding, to have had no reasonable cause to believe such person's conduct was unlawful, if such person's action is based on good faith reliance on the records or books of account of the Corporation or another enterprise, or on information supplied to such person by the officers of the Corporation or another enterprise in the course of their duties, or on the advice of legal counsel for the Corporation or another enterprise or on information or records given or reports made to the Corporation or another enterprise by an independent certified public accountant or by an appraiser or other expert selected with reasonable care by the Corporation or another enterprise. The term "another enterprise" as used in this Section 7.4 shall mean any other corporation or any partnership, joint venture, trust, employee benefit plan or other enterprise of which such person is or was serving at the request of the Corporation as a director, officer, employee or agent. The provisions of this Section 7.4 shall not be deemed to be exclusive or to limit in any way the circumstances in which a person may be deemed to have met the applicable standard of conduct set forth in Sections 7.1 or 7.2, as the case may be.

7.5 Right of Claimant to Bring Suit. Notwithstanding any contrary determination in the specific case under Section 7.3, and notwithstanding the absence of any determination thereunder, if (i) following the final disposition of the applicable proceeding, a claim for indemnification under Sections 7.1 or 7.2 of this Article VII is not paid in full by the Corporation within ninety (90) days after the later of a written claim for indemnification has been received by the Corporation, or (ii) a claim for advancement of expenses under Section 7.6 of this Article VII is not paid in full by the Corporation within thirty (30) days after the Corporation has received a statement or statements requesting such amounts to be advanced, the claimant may at any time thereafter (but not before) bring suit against the Corporation in the Court of Chancery in the State of Delaware to recover the unpaid amount of the claim, together with interest thereon, or to obtain advancement of expenses, as applicable. It shall be a defense to any such action brought to enforce a right to indemnification (but not in an action brought to enforce a right to an advancement of expenses) that the claimant has not met the standards of conduct which make it permissible under the DGCL (or other applicable law) for the Corporation to indemnify the claimant for the amount claimed, but the burden of proving such defense shall be on the Corporation. Neither a contrary determination in the specific case under Section 7.3 nor the absence of any determination thereunder shall be a defense to such application or create a presumption that the claimant has not met any applicable standard of conduct. If successful, in whole or in part, the claimant shall also be entitled to be paid the expense of prosecuting such claim, including reasonable attorneys' fees incurred in connection therewith, to the fullest extent permitted by applicable law.

7.6 Expenses Payable in Advance. Expenses, including without limitation attorneys' fees, incurred by a current or former director or officer in defending any civil, criminal, administrative or investigative action, suit or proceeding to which such person is a party or is threatened to be made a party or otherwise involved as a witness or otherwise by reason of the fact that such person is or was a director or officer of the Corporation, or, while a director or officer of the Corporation, is or was serving at the request of the Corporation as a director, officer, employee or agent of another Corporation, partnership, joint venture, trust, employee benefit plan or other enterprise, shall be paid by the Corporation in advance of the final disposition of such action, suit or proceeding upon receipt of an undertaking by or on behalf of such current or former director or officer to repay such amount if it shall ultimately be determined that such person is not entitled to be indemnified by the Corporation as authorized in this Article VII or otherwise.

[Table of Contents](#)

7.7 Nonexclusivity of Indemnification and Advancement of Expenses. The rights to indemnification and advancement of expenses provided by or granted pursuant to this Article VII shall not be deemed exclusive of any other rights to which those seeking indemnification or advancement of expenses may be entitled under the Certificate of Incorporation, any agreement, vote of stockholders or disinterested directors or otherwise, both as to action in such person's official capacity and as to action in another capacity while holding such office, it being the policy of the Corporation that, subject to Section 7.11, indemnification of the persons specified in Sections 7.1 and 7.2 shall be made to the fullest extent permitted by law. The provisions of this Article VII shall not be deemed to preclude the indemnification of any person who is not specified in Sections 7.1 or 7.2 but whom the Corporation has the power or obligation to indemnify under the provisions of the DGCL, or otherwise.

7.8 Insurance. The Corporation may purchase and maintain insurance on behalf of any person who is or was a director, officer, employee or agent of the Corporation, or is or was serving at the request of the Corporation as a director, officer, employee or agent of another corporation, partnership, joint venture, trust, employee benefit plan or other enterprise against any liability asserted against such person and incurred by such person in any such capacity, or arising out of such person's status as such, whether or not the Corporation would have the power or the obligation to indemnify such person against such liability under the provisions of this Article VII.

7.9 Certain Definitions. For purposes of this Article VII, references to "the Corporation" shall include, in addition to the resulting corporation, any constituent corporation (including any constituent of a constituent) absorbed in a consolidation or merger which, if its separate existence had continued, would have had power and authority to indemnify its directors, officers, employees or agents so that any person who is or was a director or officer of such constituent corporation, or, while a director or officer of such constituent corporation, is or was serving at the request of such constituent corporation as a director, officer, employee or agent of another corporation, partnership, joint venture, trust, employee benefit plan or other enterprise, shall stand in the same position under the provisions of this Article VII with respect to the resulting or surviving corporation as such person would have with respect to such constituent corporation if its separate existence had continued. For purposes of this Article VII, references to "fines" shall include any excise taxes assessed on a person with respect of any employee benefit plan; and references to "serving at the request of the Corporation" shall include any service as a director, officer, employee or agent of the Corporation which imposes duties on, or involves services by, such director, officer, employee or agent with respect to an employee benefit plan, its participants or beneficiaries; and a person who acted in good faith and in a manner such person reasonably believed to be in the interest of the participants and beneficiaries of an employee benefit plan shall be deemed to have acted in a manner "not opposed to the best interests of the Corporation" as referred to in this Article VII.

7.10 Survival of Indemnification and Advancement of Expenses. The indemnification and advancement of expenses provided by, or granted pursuant to, this Article VII shall continue as to a person who has ceased to be a director or officer and shall inure to the benefit of the heirs, executors and administrators of such a person.

7.11 Limitation on Indemnification. Notwithstanding anything contained in this Article VII to the contrary, except for proceedings to enforce rights to indemnification or advancement of expenses (which shall be governed by Section 7.5), the Corporation shall not be obligated to indemnify any current or former director or officer in connection with an action, suit proceeding (or part thereof) initiated by such person unless such action, suit or proceeding (or part thereof) was authorized by the Board.

7.12 Contract Rights. The obligations of the Corporation under this Article VII to indemnify, and advance expenses to, a person who is or was a director or officer of the Corporation shall be considered a contract between the Corporation and such person, and no modification or repeal of any provision of this Article VII shall affect, to the detriment of such person, such obligations of the Corporation in connection with a claim based on any act or failure to act occurring before such modification or repeal.

NAUTICUS ROBOTICS, INC.
2022 OMNIBUS INCENTIVE PLAN

Effective [DATE]

Section 1. General.

The purposes of the Nauticus Robotics, Inc. 2022 Omnibus Incentive Plan (the “Plan”) are to (a) encourage the profitability and growth of the Company through short-term and long-term incentives that are consistent with the Company’s objectives; (b) give Participants an incentive for excellence in individual performance; (c) promote teamwork among Participants; and (d) give the Company a significant advantage in attracting and retaining key Employees, Directors and Consultants. To accomplish such purposes, the Plan provides that the Company may grant (i) Options, (ii) Stock Appreciation Rights, (iii) Restricted Shares, (iv) Restricted Stock Units, (v) Performance-Based Awards (including performance-based Restricted Shares and Restricted Stock Units), (vi) Other Share-Based Awards, (vii) Other Cash-Based Awards or (viii) any combination of the foregoing. The Plan was originally adopted in connection with the consummation of the Company’s going public business combination (the “Going Public Transaction”) contemplated by that certain Agreement and Plan of Merger, entered into on [DATE], by and among the Company (f/k/a CleanTech Acquisition Corp.), a Delaware corporation, [Merger Sub.], a Texas corporation, Houston Mechatronics, Inc., a Texas corporation and Nicolaus Radford in his capacity as the Stockholder Representative thereunder (the “Merger Agreement”).

Section 2. Definitions.

For purposes of the Plan, the following terms shall be defined as set forth below:

(a) “Administrator” means the Board, or, if and to the extent the Board does not administer the Plan, the Committee in accordance with Section 3 of the Plan.

(b) “Affiliate” means a Person that directly, or indirectly through one or more intermediaries, controls, or is controlled by, or is under common control with, the Person specified. An entity shall be deemed an Affiliate of the Company for purposes of this definition only for such periods as the requisite ownership or control relationship is maintained. For purposes of this definition, “control” (including with correlative meanings, the terms “controlling,” “controlled by,” or “under common control with”), as used with respect to any Person, shall mean the possession, directly or indirectly, of the power to direct or cause the direction of the management and policies of such Person, whether through the ownership of voting securities or by contract or otherwise.

(c) “Articles of Incorporation” means the articles of incorporation of the Company, as amended and/or restated and in effect from time to time.

(d) “Automatic Exercise Date” means, with respect to an Option or a Stock Appreciation Right, the last business day of the applicable term of the Option pursuant to Section 7(k) or the Stock Appreciation Right pursuant to Section 8(h).

(e) “Award” means any Option, Stock Appreciation Right, Restricted Share, Restricted Stock Unit, Performance-Based Award, Other Share-Based Award or Other Cash-Based Award granted under the Plan.

(f) “Award Agreement” means a written agreement, contract or other instrument or document evidencing the terms and conditions of an individual Award granted under the Plan. Evidence of an Award may be in written or electronic form, may be limited to notation on the books and records of the Company and, with the approval of the Administrator, need not be signed by a representative of the Company or a Participant. Any shares of Common Stock that become deliverable to the Participant pursuant to the Plan may be issued in certificate form in the name of the Participant or in book-entry form in the name of the Participant. Each Award Agreement shall be subject to the terms and conditions of the Plan.

(g) “Beneficial Owner” (or any variant thereof) has the meaning defined in Rule 13d-3 under the Exchange Act.

(h) “Board” means the Board of Directors of the Company.

Table of Contents

(i) “Bylaws” means the bylaws of the Company, as may be amended and/or restated from time to time.

(j) “Cause” shall have the meaning assigned to such term in any Company, Subsidiary or Affiliate unexpired employment, severance, or similar agreement or Award Agreement with a Participant, or if no such agreement exists or if such agreement does not define “Cause” (or a word of like import), Cause means (i) the Participant’s breach of fiduciary duty or duty of loyalty to the Company, (ii) the Participant’s conviction of or plea of nolo contendere to a felony or a crime involving moral turpitude, (iii) the Participant’s failure, refusal or neglect to perform and discharge his or her duties and responsibilities on behalf of the Company or a Subsidiary of the Company (other than by reason of Disability) or to comply with any lawful directive of the Board or its designee, (iv) the Participant’s breach of any written policy of the Company or a Subsidiary or Affiliate thereof (including, without limitation, those relating to sexual harassment or the disclosure or misuse of confidential information), (v) the Participant’s breach of any agreement with the Company or a Subsidiary or Affiliate thereof (including, without limitation, any confidentiality, non-competition, non-solicitation or assignment of inventions agreement), (vi) the Participant’s commission of fraud, dishonesty, theft, embezzlement, self-dealing, misappropriation or other malfeasance against the business of the Company or a Subsidiary or Affiliate thereof, or (vii) the Participant’s commission of acts or omissions constituting gross negligence or gross misconduct in the performance of any aspect of his or her lawful duties or responsibilities, which have or may be expected to have an adverse effect on the Company, its Subsidiaries or Affiliates. A Participant’s employment shall be deemed to have terminated for “Cause” if, on the date his or her employment terminates, facts and circumstances exist that would have justified a termination for Cause, to the extent that such facts and circumstances are discovered within three (3) months following such termination. The Administrator, in its absolute discretion, shall determine the effect of all matters and questions relating to whether a Participant has been discharged for Cause.

(k) “Change in Capitalization” means any (i) merger, consolidation, reclassification, recapitalization, spin-off, spin-out, repurchase or other reorganization or corporate transaction or event, (ii) extraordinary dividend (whether in the form of cash, shares of Common Stock or other property), stock split or reverse stock split, (iii) combination or exchange of shares, (iv) other change in corporate structure or (v) payment of any other distribution, which, in any such case, the Administrator determines, in its sole discretion, affects the Common Stock such that an adjustment pursuant to Section 5 of the Plan is appropriate.

(l) “Change in Control” means the occurrence of any of the following:

(i) any Person, other than the Company or a Subsidiary thereof, becomes the Beneficial Owner, directly or indirectly, of securities of the Company representing more than fifty percent (50%) of the combined voting power of the Company’s then outstanding voting securities (the “Outstanding Company Voting Securities”), excluding any Person who becomes such a Beneficial Owner in connection with a transaction described in clause (A) of paragraph (iii) below or any acquisition directly from the Company; or

(ii) the following individuals cease for any reason to constitute a majority of the number of Directors then serving on the Board: individuals who, during any period of two (2) consecutive years, constitute the Board and any new Director (other than a Director whose initial assumption of office is in connection with an actual or threatened election contest, including, but not limited to, a consent solicitation, relating to the election of Directors of the Company) whose appointment or election by the Board or nomination for election by the Company’s stockholders was approved or recommended by a vote of at least two-thirds ($\frac{2}{3}$) of the Directors then still in office who either were Directors at the beginning of the two (2) year period or whose appointment, election or nomination for election was previously so approved or recommended; or

(iii) the consummation of a merger or consolidation of the Company or any Subsidiary thereof with any other corporation, other than a merger or consolidation (A) that results in the Outstanding Company Voting Securities immediately prior thereto continuing to represent (either by remaining outstanding or by being converted into voting securities of the surviving entity) at least fifty percent (50%) of the combined voting power of the Outstanding Company Voting Securities (or such surviving entity or, if the Company or the entity surviving such merger is then a subsidiary, the ultimate parent thereof) outstanding immediately after such merger or consolidation, and (B) immediately following which the individuals who comprise the Board immediately prior thereto constitute at least a majority of the Board of the entity surviving such merger or consolidation or, if the Company or the entity surviving such merger is then a subsidiary, the ultimate parent thereof; or

[Table of Contents](#)

(iv) the consummation of a plan of complete liquidation or dissolution of the Company or there is consummated an agreement for the sale or disposition by the Company of all or substantially all of the Company's assets, other than (A) a sale or disposition by the Company of all or substantially all of the Company's assets to an entity, at least fifty percent (50%) of the combined voting power of the voting securities of which are owned directly or indirectly by stockholders of the Company following the completion of such transaction in substantially the same proportions as their ownership of the Company immediately prior to such sale or (B) a sale or disposition of all or substantially all of the Company's assets immediately following which the individuals who comprise the Board immediately prior thereto constitute at least a majority of the board of directors of the entity to which such assets are sold or disposed or, if such entity is a subsidiary, the ultimate parent thereof.

For each Award that constitutes deferred compensation under Code Section 409A, a Change in Control (where applicable) shall be deemed to have occurred under the Plan with respect to such Award only if a change in the ownership or effective control of the Company or a change in ownership of a substantial portion of the assets of the Company also constitutes a "change in control event" under Code Section 409A.

Notwithstanding the foregoing, a "Change in Control" shall not be deemed to have occurred by virtue of the consummation of any transaction or series of integrated transactions immediately following which the holders of Class A Common Stock immediately prior to such transaction or series of transactions continue to have substantially the same proportionate ownership in an entity which owns all or substantially all of the assets of the Company immediately following such transaction or series of transactions.

(m) "Change in Control Price" shall have the meaning set forth in Section 12 of the Plan.

(n) "Code" means the Internal Revenue Code of 1986, as amended from time to time, or any successor thereto. Any reference to a section of the Code shall be deemed to include a reference to any regulations promulgated thereunder.

(o) "Committee" means any committee or subcommittee the Board may appoint to administer the Plan. Subject to the discretion of the Board, the Committee shall be composed entirely of individuals who meet the qualifications of a "non-employee director" within the meaning of Rule 16b-3 under the Exchange Act and any other qualifications required by the applicable stock exchange on which the shares of Common Stock are traded. If at any time or to any extent the Board shall not administer the Plan, then the functions of the Administrator specified in the Plan shall be exercised by the Committee. Except as otherwise provided in the Company's Articles of Incorporation or Bylaws, any action of the Committee with respect to the administration of the Plan shall be taken by a majority vote at a meeting at which a quorum is duly constituted or unanimous written consent of the Committee's members.

(p) "Common Stock" means common stock, \$0.0001 par value per share, of the Company (and any stock or other securities into which such shares of common stock may be converted or into which they may be exchanged).

(q) "Company" means Nauticus Robotics, Inc., a Delaware corporation (or any successor corporation, except as the term "Company" is used in the definition of "Change in Control" above).

(r) "Consultant" means any current or prospective consultant or independent contractor of the Company or an Affiliate thereof, in each case, who is not an Employee, Executive Officer or Non-Employee Director.

(s) "Director" means any individual who is a member of the Board on or after the Effective Date.

(t) "Disability" means, with respect to any Participant who is an Employee, a permanent and total disability as defined in Code Section 22(e)(3).

(u) "Effective Date" shall have the meaning set forth in Section 22 of the Plan.

(v) "Eligible Director" means a person who is (i) with respect to actions intended to obtain an exemption from Section 16(b) of the Exchange Act pursuant to Rule 16b-3, a "non-employee director" within the meaning of Rule 16b-3; and (ii) with respect to actions undertaken to comply with the rules of the New York Stock Exchange, the Nasdaq Stock Market or any other securities exchange or inter-dealer quotation system on which the Common Stock is listed or quoted, an "independent director" under the rules of the New York Stock Exchange, the Nasdaq Stock Market or any other securities exchange or inter-dealer quotation system on which the Common Stock is listed or quoted, or a person meeting any similar requirement under any successor rule or regulation.

Table of Contents

(w) “Eligible Recipient” means: (i) an Employee; (ii) a Non-Employee Director; or (iii) a Consultant, in each case, who has been selected as an eligible recipient under the Plan by the Administrator; provided, that any Awards granted prior to the date an Eligible Recipient first performs services for the Company or an Affiliate thereof will not become vested or exercisable, and no shares of Common Stock shall be issued or other payment made to such Eligible Recipient with respect to such Awards, prior to the date on which such Eligible Recipient first performs services for the Company or an Affiliate thereof. Notwithstanding the foregoing, to the extent required to avoid the imposition of additional taxes under Code Section 409A, “Eligible Recipient” means: an (1) Employee; (2) a Non-Employee Director; or (3) a Consultant, in each case, of the Company or a Subsidiary thereof, who has been selected as an eligible recipient under the Plan by the Administrator.

(x) “Employee” shall mean any current or prospective employee of the Company or an Affiliate thereof, as described in Treasury Regulation Section 1.421-1(h), including an Executive Officer or Director who is also treated as an employee.

(y) “Exchange Act” means the Securities Exchange Act of 1934, as amended from time to time.

(z) “Executive Officer” means each Participant who is an executive officer (within the meaning of Rule 3b-7 under the Exchange Act) of the Company.

(aa) “Exercise Price” means, with respect to any Award under which the holder may purchase shares of Common Stock, the price per share at which a holder of such Award granted hereunder may purchase shares of Common Stock issuable upon exercise of such Award, as determined by the Administrator in accordance with Code Section 409A, as applicable.

(bb) “Fair Market Value” as of a particular date shall mean: (i) if the shares of Common Stock are listed on any established stock exchange or a national market system, including, without limitation, the New York Stock Exchange or the Nasdaq Stock Market, the Fair Market Value shall be the closing price of a Share (or if no sales were reported, the closing price on the date immediately preceding such date) as quoted on such exchange or system on the day of determination; (ii) if the shares of Common Stock are not then listed on a national securities exchange, the average of the highest reported bid and lowest reported asked prices for a Share as reported by the National Association of Securities Dealers, Inc. Automated Quotations System for the last preceding date on which there was a sale of such stock in such market; or (iii) whether or not the shares of Common Stock are then listed on a national securities exchange or traded in an over-the-counter market or the value of such shares is not otherwise determinable, such value as determined by the Administrator in good faith and in a manner not inconsistent with the regulations under Code Section 409A.

(cc) “Free Standing Rights” shall have the meaning set forth in Section 8(a) of the Plan.

(dd) “Incentive Stock Option” means an Option that is designated by the Committee as an incentive stock option within the meaning of Section 422 of the Code and that meets the requirements set out in the Plan.

(ee) “Non-Employee Director” means a Director who is not an Employee.

(ff) “Nonqualified Stock Option” means an Option that by its terms does not qualify or is not intended to qualify as an Incentive Stock Option.

(gg) “Outstanding Common Stock” means the then-outstanding shares of Common Stock of the Company, taking into account as outstanding for this purpose such Common Stock issuable upon the exercise of Options or warrants, the conversion of convertible stock or debt, and the exercise of any similar right to acquire such Common Stock.

(hh) “Option” means an option to purchase shares of Common Stock granted pursuant to Section 7 of the Plan.

(ii) “Other Cash-Based Award” means a cash Award granted to a Participant under Section 11 of the Plan, including cash awarded as a bonus or upon the attainment of Performance Goals or otherwise as permitted under the Plan.

(jj) “Other Share-Based Award” means a right or other interest granted to a Participant under the Plan that may be denominated or payable in, valued in whole or in part by reference to, or otherwise based on or related to, shares of Common Stock, including, but not limited to, unrestricted shares of Common Stock or dividend equivalents, each of which may be subject to the attainment of Performance Goals or a period of continued employment or other terms or conditions as permitted under the Plan.

[Table of Contents](#)

(kk) “**Participant**” means any Eligible Recipient selected by the Administrator, pursuant to the Administrator’s authority provided for in Section 3 of the Plan, to receive an Award under the Plan, and, upon his or her death, his or her successors, heirs, executors and administrators, as the case may be, solely with respect to any Awards outstanding at the date of the Eligible Recipient’s death.

(ll) “**Performance-Based Award**” means any Award granted under the Plan that is subject to one or more Performance Goals. Any dividends or dividend equivalents payable or credited to a Participant with respect to any unvested Performance-Based Award shall be subject to the same Performance Goals as the shares of Common Stock or units underlying the Performance-Based Award.

(mm) “**Performance Goals**” means performance goals based on performance criteria selected by the Administrator, which may include, but are not limited to, any of the following: (i) earnings before interest and taxes; (ii) earnings before interest, taxes, depreciation and amortization; (iii) net operating profit after tax; (iv) cash flow; (v) revenue; (vi) net revenues; (vii) sales; (viii) days sales outstanding; (ix) income; (x) net income; (xi) operating income; (xii) net operating income; (xiii) operating margin; (xiv) earnings; (xv) earnings per share; (xvi) return on equity; (xvii) return on investment; (xviii) return on capital; (xix) return on assets; (xx) return on net assets; (xxi) total shareholder return; (xxii) economic profit; (xxiii) market share; (xxiv) appreciation in the fair market value, book value or other measure of value of the shares of Common Stock; (xxv) expense or cost control; (xxvi) working capital; (xxvii) customer satisfaction; (xxviii) employee retention or employee turnover; (xxix) employee satisfaction or engagement; (xxx) environmental, health or other safety goals; (xxxi) individual performance; (xxxii) strategic objective milestones; (xxxiii) any other criteria specified by the Administrator in its sole discretion; and (xxxiv) any combination of, or a specified increase or decrease in, as applicable, any of the foregoing. Where applicable, the Performance Goals may be expressed in terms of attaining a specified level of the particular criteria or the attainment of a percentage increase or decrease in the particular criteria, and may be applied to one or more of the Company or an Affiliate thereof, or a division or strategic business unit of the Company, or may be applied to the performance of the Company relative to a market index, a group of other companies or a combination thereof, all as determined by the Administrator. The Performance Goals may include a threshold level of performance below which no payment shall be made (or no vesting shall occur), levels of performance at which specified payments shall be made (or specified vesting shall occur), and a maximum level of performance above which no additional payment shall be made (or at which full vesting shall occur). At the time such an Award is granted, the Administrator may specify any reasonable definition of the Performance Goals it uses. Such definitions may provide for equitable adjustments to the Performance Goals in recognition of unusual or non-recurring events affecting the Company or an Affiliate thereof or the financial statements of the Company or an Affiliate thereof, in response to changes in applicable laws or regulations, or to account for items of gain, loss or expense determined to be unusual in nature, infrequent in occurrence or unusual in nature and infrequent in occurrence or related to the disposal of a segment of a business or related to a change in accounting principles. If the Administrator determines that a change in the business, operations, corporate structure or capital structure of the Company or the manner in which the Company or an Affiliate conducts its business, or other events or circumstances render performance goals to be unsuitable, the Administrator may modify such Performance Goals in whole or in part, as the Committee deems appropriate. If a Participant is promoted, demoted or transferred to a different business unit or function during a performance period, the Administrator may determine that the Performance Goals or performance period are no longer appropriate and may (x) adjust, change or eliminate the Performance Goals or the applicable performance period as it deems appropriate to make such goals and period comparable to the initial goals and period, or (y) make a cash payment to the Participant in an amount determined by the Administrator.

(nn) “**Person**” shall have the meaning given in Section 3(a)(9) of the Exchange Act, as modified and used in Sections 13(d) and 14(d) thereof, however, a Person shall not include (i) the Company or any of its Subsidiaries; (ii) a trustee or other fiduciary holding securities under an employee benefit plan of the Company or any of its Subsidiaries; (iii) an underwriter temporarily holding securities pursuant to an offering of such securities; or (iv) a corporation owned, directly or indirectly, by the stockholders of the Company in substantially the same proportion as their ownership of stock of the Company.

(oo) “**Plan**” means this Nauticus Robotics, Inc. 2022 Omnibus Incentive Plan, as amended and/or amended and restated from time to time.

[Table of Contents](#)

(pp) “Related Rights” shall have the meaning set forth in Section 8(a) of the Plan.

(qq) “Restricted Shares” means an Award of shares of Common Stock granted pursuant to Section 9 of the Plan subject to certain restrictions that lapse at the end of a specified period or periods.

(rr) “Restricted Stock Unit” means a notional account established pursuant to an Award granted to a Participant, as described in Section 10 of the Plan, that is (i) valued solely by reference to shares of Common Stock, (ii) subject to restrictions specified in the Award Agreement, and (iii) payable in cash or in shares of Common Stock (as specified in the Award Agreement). The Restricted Stock Units awarded to the Participant will vest according to the time-based criteria or Performance Goals, and vested Restricted Stock Units will be settled at the time(s), specified in the Award Agreement.

(ss) “Restricted Period” means the period of time determined by the Administrator during which an Award or a portion thereof is subject to restrictions or, as applicable, the period of time within which performance is measured for purposes of determining whether an Award has been earned.

(tt) “Rule 16b-3” shall have the meaning set forth in Section 3(a) of the Plan.

(uu) “Securities Act” means the Securities Act of 1933, as amended from time to time.

(vv) “Stock Appreciation Right” means the right pursuant to an Award granted under Section 8 of the Plan to receive an amount equal to the excess, if any, of (i) the aggregate Fair Market Value, as of the date such Award or portion thereof is surrendered, of the shares of Common Stock covered by such Award or such portion thereof, over (ii) the aggregate Exercise Price of such Award or such portion thereof.

(ww) “Subsidiary” means, with respect to any Person, as of any date of determination, any other Person as to which such first Person owns or otherwise controls, directly or indirectly, more than fifty percent (50%) of the voting shares or other similar interests or a sole general partner interest or managing member or similar interest of such other Person. An entity shall be deemed a Subsidiary of the Company for purposes of this definition only for such periods as the requisite ownership or control relationship is maintained. Notwithstanding the foregoing, in the case of an Incentive Stock Option or any determination relating to an Incentive Stock Option, “Subsidiary” means a corporation that is a subsidiary of the Company within the meaning of Code Section 424(f).

(xx) “Substitute Award” shall mean an Award granted under the Plan upon the assumption of, or in substitution for, outstanding equity awards granted by a company or other entity in connection with a corporate transaction, such as a merger, combination, consolidation, or acquisition of property or stock; *provided, however*, that in no event shall the term “Substitute Award” be construed to refer to an award made in connection with the cancellation and repricing of an Option or Stock Appreciation Right. For the avoidance of doubt, the assumed stock options referenced at Section 4(a)(ii) of the Plan shall not constitute Substitute Awards and shall be treated as Awards granted under the Plan, including for purposes of the Plan’s share reserve and the share recycling provisions set forth in Section 4(c) of the Plan.

Section 3. Administration.

(a) The Plan shall be administered by the Administrator in accordance with the requirements of Rule 16b-3 under the Exchange Act (“Rule 16b-3”), to the extent applicable.

(b) Pursuant to the terms of the Plan, the Administrator, subject, in the case of any Committee, to any restrictions on the authority delegated to it by the Board, shall have the power and authority, without limitation:

(i) to select those Eligible Recipients who shall be Participants;

(ii) to determine whether and to what extent Options, Stock Appreciation Rights, Restricted Shares, Restricted Stock Units, Other Share-Based Awards, Other Cash-Based Awards or a combination of any of the foregoing, are to be granted hereunder to Participants;

(iii) to determine the number of shares of Common Stock to be made subject to each Award;

(iv) to determine the terms and conditions, not inconsistent with the terms of the Plan, of each Award granted hereunder, including, but not limited to, (A) the restrictions applicable to Awards and the conditions under which restrictions applicable to such Awards shall lapse, (B) the Performance Goals and performance periods applicable to Awards, if any, (C) the Exercise Price of each Award, (D) the vesting schedule applicable

to each Award, (E) any confidentiality or restrictive covenant provisions applicable to the Award, and (F) subject to the requirements of Code Section 409A (to the extent applicable), any amendments to the terms and conditions of outstanding Awards, including, but not limited to, extending the exercise period of such Awards and accelerating the vesting schedule of such Awards;

(v) to determine the terms and conditions, not inconsistent with the terms of the Plan, which shall govern all Award Agreements evidencing Options, Stock Appreciation Rights, Restricted Shares, Restricted Stock Units or Other Share-Based Awards, Other Cash-Based Awards or any combination of the foregoing granted hereunder;

(vi) to determine Fair Market Value;

(vii) to determine the duration and purpose of leaves of absence which may be granted to a Participant without constituting termination of the Participant's employment for purposes of Awards granted under the Plan;

(viii) to adopt, alter and repeal such administrative rules, guidelines and practices governing the Plan as it shall from time to time deem advisable;

(ix) to reconcile any inconsistency in, correct any defect in and/or supply any omission in the Plan, any Award Agreement or other instrument or agreement relating to the Plan or an Award granted under the Plan; and

(x) to construe and interpret the terms and provisions of the Plan and any Award issued under the Plan (and any Award Agreement relating thereto), and to otherwise supervise the administration of the Plan and to exercise all powers and authorities either specifically granted under the Plan or necessary and advisable in the administration of the Plan.

(c) Except to the extent prohibited by applicable law or the applicable rules and regulations of any securities exchange or inter-dealer quotation system on which the securities of the Company are listed or traded, the Administrator may allocate all or any portion of its responsibilities and powers to any one (1) or more of its members and may delegate all or any part of its responsibilities and powers to any person or persons selected by it. Any such allocation or delegation may be revoked by the Committee at any time. Without limiting the generality of the foregoing, the Committee may delegate to one (1) or more officers of the Company, the authority to act on behalf of the Committee with respect to any matter, right, obligation, or election which is the responsibility of, or which is allocated to, the Committee herein, and which may be so delegated as a matter of law, except for grants of Awards to Directors. Notwithstanding the foregoing in this Section 3(c), it is intended that any action under the Plan intended to qualify for the exemptions provided by Rule 16b-3 will be taken only by the Board or by a committee or subcommittee of two (2) or more Eligible Directors. However, the fact that any member of such committee or subcommittee shall fail to qualify as an Eligible Director shall not invalidate any action that is otherwise valid under the Plan.

(d) All decisions made by the Administrator pursuant to the provisions of the Plan shall be final, conclusive and binding on all persons, including the Company and the Participants. No member of the Board or the Committee, or any officer or employee of the Company or any Subsidiary thereof acting on behalf of the Board or the Committee, shall be personally liable for any action, omission, determination, or interpretation taken or made in good faith with respect to the Plan, and all members of the Board or the Committee and each and any officer or employee of the Company and of any Subsidiary thereof acting on their behalf shall, to the maximum extent permitted by law, be fully indemnified and protected by the Company in respect of any such action, omission, determination or interpretation.

Section 4. Shares Reserved for Issuance Under the Plan and Limitations on Awards.

(a) Subject to adjustment in accordance with Section 5 of the Plan, the Administrator is authorized to deliver with respect to Awards granted under the Plan an aggregate of [_____] shares of Common Stock, which includes (i) [_____] shares of Common Stock available for new issuances under the Plan and (ii) [_____] shares of Common Stock relating to a portion of outstanding stock options assumed by the Company in connection with the Going Public Transaction; provided, that the total number of shares of Common Stock that will be reserved, and that may be issued, under the Plan will automatically increase on the first trading day of each calendar year, beginning with calendar year 2023, by a number of shares of Common Stock equal to three percent (3%) of the total number of Outstanding Common Stock on the last day of the prior calendar year. Notwithstanding the foregoing, the Administrator may act prior to January 1 of a given year to provide that there will be no such increase in the share reserve for that year or that the increase in the share reserve for such year will be a lesser number of shares of Common Stock than provided herein.

(b) Notwithstanding anything herein to the contrary, the maximum number of shares of Common Stock subject to Awards granted during any fiscal year to any Non-Employee Director, taken together with any cash fees paid to such Non-Employee Director during the fiscal year with respect to such Director's service as a Non-Employee Director, shall not exceed \$[_____] (calculating the value of any such Awards based on the grant date Fair Market Value of such Awards for financial reporting purposes).

(c) Shares of Common Stock issued under the Plan may, in whole or in part, be authorized but unissued shares of Common Stock or shares that shall have been or may be reacquired by the Company in the open market, in private transactions or otherwise. Any shares of Common Stock subject to an Award under the Plan that, after the Effective Date, are forfeited, canceled, settled or otherwise terminated without a distribution of shares of Common Stock to a Participant will thereafter be deemed to be available for Awards. In applying the immediately preceding sentence, if (i) shares of Common Stock otherwise issuable or issued in respect of, or as part of, any Award are withheld to cover taxes or any applicable Exercise Price, such shares shall be treated as having been issued under the Plan and shall not be available for issuance under the Plan, and (ii) any Share-settled Stock Appreciation Rights or Options are exercised, the aggregate number of shares of Common Stock subject to such Stock Appreciation Rights or Options shall be deemed issued under the Plan and shall not be available for issuance under the Plan. In addition, shares of Common Stock (x) tendered to exercise outstanding Options or other Awards, (y) withheld to cover applicable taxes on any Awards or (z) repurchased on the open market using Exercise Price proceeds shall not be available for issuance under the Plan. For the avoidance of doubt, (A) shares of Common Stock underlying Awards that are subject to the achievement of performance goals shall be counted against the share reserve based on the target value of such Awards unless and until such time as such Awards become vested and settled in shares of Common Stock, and (B) Awards that, pursuant to their terms, may be settled only in cash shall not count against the share reserve set forth in Section 4(a).

(d) Substitute Awards shall not reduce the shares of Common Stock authorized for grant under the Plan. In the event that a company acquired by the Company or any Affiliate or with which the Company or any Affiliate combines has shares available under a pre-existing plan approved by stockholders and not adopted in contemplation of such acquisition or combination, the shares available for grant pursuant to the terms of such pre-existing plan (as adjusted, to the extent appropriate, using the exchange ratio or other adjustment or valuation ratio or formula used in such acquisition or combination to determine the consideration payable to the holders of common stock of the entities party to such acquisition or combination) may be used for Awards under the Plan and shall not reduce the shares of Common Stock authorized for grant under the Plan; *provided*, that Awards using such available shares of Common Stock shall not be made after the date awards or grants could have been made under the terms of the pre-existing plan, absent the acquisition or combination, and shall only be made to individuals who were not employed by or providing services to the Company or its Affiliates immediately prior to such acquisition or combination.

(e) In the event that the Company or an Affiliate thereof consummates a transaction described in Code Section 424(a) (e.g., the acquisition of property or stock from an unrelated corporation), persons who become Employees or Directors in account of such transaction may be granted Substitute Awards in substitution for awards granted by their former employer, and any such substitute Options or Stock Appreciation Rights may be granted with an Exercise Price less than the Fair Market Value of a Share on the grant date thereof; *provided*, however, the grant of such substitute Option or Stock Appreciation Right shall not constitute a "modification" as defined in Code Section 424(h)(3) and the applicable Treasury regulations.

Section 5. Equitable Adjustments.

In the event of any Change in Capitalization, including, without limitation, a Change in Control, an equitable substitution or proportionate adjustment shall be made, in each case, as may be determined by the Administrator, in its sole discretion, in (a) the aggregate number of shares of Common Stock reserved for issuance under the Plan, (b) the kind, number and Exercise Price subject to outstanding Options and Stock Appreciation Rights granted under the Plan; *provided, however*, that any such substitution or adjustment with respect to Options and Stock Appreciation Rights shall occur in accordance with the requirements of Code Section 409A, and (c) the kind, number and purchase price of shares of Common Stock subject to outstanding Restricted Shares or Other Share-Based Awards granted under the Plan, in each case as may be determined by the Administrator, in its sole discretion; *provided, however*, that any fractional shares of Common Stock resulting from the adjustment shall be eliminated. Such other equitable substitutions or adjustments shall be made as may be determined by the Administrator, in its sole discretion. Without limiting the generality of the foregoing, in connection with a Change in Capitalization, the Administrator may provide,

[Table of Contents](#)

in its sole discretion, for the cancellation of any outstanding Award granted hereunder (i) in exchange for payment in cash or other property having an aggregate Fair Market Value of the shares of Common Stock covered by such Award, reduced by the aggregate Exercise Price or purchase price thereof, if any, and (ii) with respect to any Awards for which the Exercise Price or purchase price per share of Common Stock is greater than or equal to the then current Fair Market Value per share of Common Stock, for no consideration. Notwithstanding anything contained in the Plan to the contrary, any adjustment with respect to an Incentive Stock Option due to an adjustment or substitution described in this Section 5 shall comply with the rules of Code Section 424(a), and in no event shall any adjustment be made which would render any Incentive Stock Option granted hereunder to be disqualified as an incentive stock option for purposes of Code Section 422. The Administrator's determinations pursuant to this Section 5 shall be final, binding and conclusive.

Section 6. Eligibility.

The Participants under the Plan shall be selected from time to time by the Administrator, in its sole discretion, from among Eligible Recipients.

Section 7. Options.

(a) *General.* The Administrator may, in its sole discretion, grant Options to Participants. Solely with respect to Participants who are Employees, the Administrator may grant Incentive Stock Options, Nonqualified Stock Options or a combination of both. With respect to all other Participants, the Administrator may grant only Nonqualified Stock Options. Each Participant who is granted an Option shall enter into an Award Agreement with the Company, containing such terms and conditions as the Administrator shall determine, in its sole discretion, which Award Agreement shall specify whether the Option is an Incentive Stock Option or a Nonqualified Stock Option and shall set forth, among other things, the Exercise Price of the Option, the term of the Option and provisions regarding exercisability of the Option granted thereunder. The provisions of each Option need not be the same with respect to each Participant. More than one Option may be granted to the same Participant and be outstanding concurrently hereunder. Options granted under the Plan shall be subject to the terms and conditions set forth in this Section 7 and shall contain such additional terms and conditions, not inconsistent with the terms of the Plan, as the Administrator shall deem desirable and set forth in the applicable Award Agreement. The prospective recipient of an Option shall not have any rights with respect to such Award, unless and until such recipient has received an Award Agreement and, if required by the Administrator in the Award Agreement, executed and delivered a fully executed copy thereof to the Company, within a period of sixty (60) days (or such other period as the Administrator may specify) after the award date.

(b) *Limits on Incentive Stock Options.* If the Administrator grants Incentive Stock Options, then to the extent that the aggregate fair market value of shares of Common Stock with respect to which Incentive Stock Options are exercisable for the first time by any individual during any calendar year (under all plans of the Company) exceeds \$100,000, such Options will be treated as Nonqualified Stock Options to the extent required by Code Section 422. Subject to Section 5, the maximum number of shares that may be issued pursuant to Options intended to be Incentive Stock Options is [] shares of Common Stock and, for the avoidance of doubt, such share limit shall not be subject to the annual adjustment provided in Section 4(b).

(c) *Exercise Price.* The Exercise Price of shares of Common Stock purchasable under an Option shall be determined by the Administrator in its sole discretion at the time of grant; *provided, however,* that (i) in no event shall the Exercise Price of an Option be less than one hundred percent (100%) of the Fair Market Value of a Share on the date of grant, and (ii) no Incentive Stock Option granted to a ten percent (10%) stockholder of the Company (within the meaning of Code Section 422(b)(6)) shall have an Exercise Price per Share less than one hundred ten percent (110%) of the Fair Market Value of a Share on such date.

(d) *Option Term.* The maximum term of each Option shall be fixed by the Administrator, but in no event shall (i) an Option be exercisable more than ten (10) years after the date such Option is granted, and (ii) an Incentive Stock Option granted to a ten percent (10%) stockholder of the Company (within the meaning of Code Section 422(b)(6)) be exercisable more than five (5) years after the date such Option is granted. Each Option's term is subject to earlier expiration pursuant to the applicable provisions in the Plan and the Award Agreement. Notwithstanding the foregoing, the Administrator shall have the authority to accelerate the exercisability of any outstanding Option at such time and under such circumstances as the Administrator, in its sole discretion, deems appropriate. Notwithstanding any contrary provision in this Plan (including, without limitation, Section 7(h)), if, on the date an outstanding Option would expire,

[Table of Contents](#)

the exercise of the Option, including by a “net exercise” or “cashless” exercise, would violate applicable securities laws or any insider trading policy maintained by the Company from time to time, the expiration date applicable to the Option will be extended, except to the extent such extension would violate Code Section 409A, to a date that is thirty (30) calendar days after the date the exercise of the Option would no longer violate applicable securities laws or any such insider trading policy.

(e) *Exercisability.* Each Option shall be exercisable at such time or times and subject to such terms and conditions, including the attainment of pre-established Performance Goals, as shall be determined by the Administrator in the applicable Award Agreement. The Administrator may also provide that any Option shall be exercisable only in installments, and the Administrator may waive such installment exercise provisions at any time, in whole or in part, based on such factors as the Administrator may determine in its sole discretion. Notwithstanding anything to the contrary contained herein, an Option may not be exercised for a fraction of a share.

(f) *Method of Exercise.* Options may be exercised in whole or in part by giving written notice of exercise to the Company specifying the number of shares of Common Stock to be purchased, accompanied by payment in full of the aggregate Exercise Price of the shares of Common Stock so purchased in cash or its equivalent, as determined by the Administrator. As determined by the Administrator, in its sole discretion, with respect to any Option or category of Options, payment in whole or in part may also be made (i) by means of consideration received under any cashless exercise procedure approved by the Administrator (including the withholding of shares of Common Stock otherwise issuable upon exercise), (ii) in the form of unrestricted shares of Common Stock already owned by the Participant which have a Fair Market Value on the date of surrender equal to the aggregate Exercise Price of the shares of Common Stock as to which such Option shall be exercised, (iii) any other form of consideration approved by the Administrator and permitted by applicable law, or (iv) any combination of the foregoing. In determining which methods a Participant may utilize to pay the Exercise Price, the Administrator may consider such factors as it determines are appropriate; *provided, however*, that with respect to Incentive Stock Options, all such discretionary determinations shall be made by the Administrator at the time of grant and specified in the Award Agreement.

(g) *Rights as Stockholder.* A Participant shall have no rights to dividends or any other rights of a stockholder with respect to the shares of Common Stock subject to an Option until the Participant has given written notice of the exercise thereof, has paid in full for such shares and has satisfied the requirements of Section 16 of the Plan.

(h) *Termination of Employment or Service.* Unless the applicable Award Agreement provides otherwise, in the event that the employment or service of a Participant with the Company and all Affiliates thereof shall terminate, the following terms and conditions shall apply:

(i) In the event of the termination of a Participant’s employment or service by the Company without Cause or due to a resignation by the Participant for any reason, (A) Options granted to such Participant, to the extent that they are exercisable at the time of such termination, shall remain exercisable until the date that is ninety (90) days after such termination (with such period being extended to one (1) year after the date of such termination in the event of the Participant’s death during such ninety (90) day period), on which date they shall expire, and (B) Options granted to such Participant, to the extent that they were not exercisable at the time of such termination, shall expire at the close of business on the date of such termination. Notwithstanding the foregoing, no Option shall be exercisable after the expiration of its term.

(ii) In the event of the termination of a Participant’s employment or service as a result of the Participant’s Disability or death, (A) Options granted to such Participant, to the extent that they were exercisable at the time of such termination, shall remain exercisable until the date that is one (1) year after such termination, on which date they shall expire, and (B) Options granted to such Participant, to the extent that they were not exercisable at the time of such termination, shall expire at the close of business on the date of such termination. Notwithstanding the foregoing, no Option shall be exercisable after the expiration of its term.

(iii) In the event of the termination of a Participant’s employment or service for Cause, all outstanding Options granted to such Participant shall expire at the commencement of business on the date of such termination.

(iv) For purposes of determining which Options are exercisable upon termination of employment or service for purposes of this Section 7(h), Options that are not exercisable solely due to a blackout period shall be considered exercisable.

(v) Notwithstanding anything herein to the contrary, an Incentive Stock Option may not be exercised more than three (3) months following the date as of which a Participant ceases to be an Employee for any reason other than death or Disability. In the event that an Option is exercisable following the date that is three (3) months following the date as of which a Participant ceases to be an Employee for any reason other than death or Disability, such Option shall be deemed to be a Nonqualified Stock Option.

(i) *Other Change in Employment Status.* An Option may be affected, both with regard to vesting schedule and termination, by leaves of absence, changes from full-time to part-time employment, partial disability or other changes in the employment status or service of a Participant, as evidenced in a Participant's Award Agreement.

(j) *Change in Control.* Notwithstanding anything herein to the contrary, upon a Change in Control, all outstanding Options shall be subject to Section 12 of the Plan.

(k) *Automatic Exercise.* Unless otherwise provided by the Administrator in an Award Agreement or otherwise, or as otherwise directed by the Participant in writing to the Company, each vested and exercisable Option outstanding on the Automatic Exercise Date with an Exercise Price per Share that is less than the Fair Market Value per Share as of such date shall automatically and without further action by the Participant or the Company be exercised on the Automatic Exercise Date. In the sole discretion of the Administrator, payment of the exercise price of any such Option shall be made pursuant to Section 7(f)(i) or (ii), and the Company or any Affiliate shall deduct or withhold an amount sufficient to satisfy all taxes associated with such exercise in accordance with Section 16. Unless otherwise determined by the Administrator, this Section 7(k) shall not apply to an Option if the Participant's employment or service has terminated on or before the Automatic Exercise Date. For the avoidance of doubt, no Option with an Exercise Price per Share that is equal to or greater the Fair Market Value per Share on the Automatic Exercise Date shall be exercised pursuant to this Section 7(k).

Section 8. Stock Appreciation Rights.

(a) *General.* Stock Appreciation Rights may be granted either alone ("Free Standing Rights") or in conjunction with all or part of any Option granted under the Plan ("Related Rights"). Any Related Right that relates to a Nonqualified Stock Option may be granted at the same time the Option is granted or at any time thereafter, but before the exercise or expiration of the Option. Any Related Right that relates to an Incentive Stock Option must be granted at the same time the Incentive Stock Option is granted. The Administrator shall determine the Eligible Recipients to whom, and the time or times at which, grants of Stock Appreciation Rights shall be made, the number of shares of Common Stock to be awarded, the price per Share, and all other conditions of Stock Appreciation Rights. Notwithstanding the foregoing, no Related Right may be granted for more shares of Common Stock than are subject to the Option to which it relates and any Stock Appreciation Right must be granted with an Exercise Price not less than the Fair Market Value of a share of Common Stock on the date of grant. The provisions of Stock Appreciation Rights need not be the same with respect to each Participant. Stock Appreciation Rights granted under the Plan shall be subject to the following terms and conditions set forth in this Section 8 and shall contain such additional terms and conditions, not inconsistent with the terms of the Plan, as the Administrator shall deem desirable, as set forth in the applicable Award Agreement.

(b) *Awards; Rights as Stockholder.* The prospective recipient of a Stock Appreciation Right shall not have any rights with respect to such Award, unless and until such recipient has received an Award Agreement and, if required by the Administrator in the Award Agreement, executed and delivered a fully executed copy thereof to the Company, within a period of sixty (60) days (or such other period as the Administrator may specify) after the award date. Participants who are granted Stock Appreciation Rights shall have no rights as stockholders of the Company with respect to the grant or exercise of such rights.

(c) *Exercisability.*

(i) Stock Appreciation Rights that are Free Standing Rights shall be exercisable at such time or times and subject to such terms and conditions as shall be determined by the Administrator in the applicable Award Agreement.

(ii) Stock Appreciation Rights that are Related Rights shall be exercisable only at such time or times and to the extent that the Options to which they relate shall be exercisable in accordance with the provisions of Section 7 above and this Section 8 of the Plan.

(d) *Payment Upon Exercise.*

(i) Upon the exercise of a Free Standing Right, the Participant shall be entitled to receive up to, but not more than, that number of shares of Common Stock, determined using the Fair Market Value, equal in value to the excess of the Fair Market Value as of the date of exercise over the price per share specified in the Free Standing Right multiplied by the number of shares of Common Stock in respect of which the Free Standing Right is being exercised.

(ii) A Related Right may be exercised by a Participant by surrendering the applicable portion of the related Option. Upon such exercise and surrender, the Participant shall be entitled to receive up to, but not more than, that number of shares of Common Stock, determined using the Fair Market Value, equal in value to the excess of the Fair Market Value as of the date of exercise over the Exercise Price specified in the related Option multiplied by the number of shares of Common Stock in respect of which the Related Right is being exercised. Options which have been so surrendered, in whole or in part, shall no longer be exercisable to the extent the Related Rights have been so exercised.

(iii) Notwithstanding the foregoing, the Administrator may determine to settle the exercise of a Stock Appreciation Right in cash (or in any combination of shares of Common Stock and cash).

(e) *Termination of Employment or Service.*

(i) Subject to Section 8(f), in the event of the termination of employment or service with the Company and all Affiliates thereof of a Participant who has been granted one or more Free Standing Rights, such rights shall be exercisable at such time or times and subject to such terms and conditions as shall be determined by the Administrator in the applicable Award Agreement.

(ii) Subject to Section 8(f), in the event of the termination of employment or service with the Company and all Affiliates thereof of a Participant who has been granted one or more Related Rights, such rights shall be exercisable at such time or times and subject to such terms and conditions as set forth in the related Options.

(f) *Term.*

(i) The term of each Free Standing Right shall be fixed by the Administrator, but no Free Standing Right shall be exercisable more than ten (10) years after the date such right is granted.

(ii) The term of each Related Right shall be the term of the Option to which it relates, but no Related Right shall be exercisable more than ten (10) years after the date such right is granted.

(g) *Change in Control.* Notwithstanding anything herein to the contrary, upon a Change in Control, all outstanding Stock Appreciation Rights shall be subject to Section 12 of the Plan.

(h) *Automatic Exercise.* Unless otherwise provided by the Administrator in an Award Agreement or otherwise, or as otherwise directed by the Participant in writing to the Company, each vested and exercisable Stock Appreciation Right outstanding on the Automatic Exercise Date with an Exercise Price per Share that is less than the Fair Market Value per Share as of such date shall automatically and without further action by the Participant or the Company be exercised on the Automatic Exercise Date. The Company or any Affiliate shall deduct or withhold an amount sufficient to satisfy all taxes associated with such exercise in accordance with Section 16. Unless otherwise determined by the Administrator, this Section 8(h) shall not apply to a Stock Appreciation Right if the Participant's employment or service has terminated on or before the Automatic Exercise Date. For the avoidance of doubt, no Stock Appreciation Right with an Exercise Price per Share that is equal to or greater than the Fair Market Value per Share on the Automatic Exercise Date shall be exercised pursuant to this Section 8(h).

Section 9. Restricted Shares.

(a) *General.* Each Award of Restricted Shares granted under the Plan shall be evidenced by an Award Agreement. Restricted Shares may be issued either alone or in addition to other Awards granted under the Plan. The Administrator shall determine the Eligible Recipients to whom, and the time or times at which, grants of Restricted Shares shall be made; the number of shares of Common Stock to be awarded; the price, if any, to be paid by the Participant for the acquisition of Restricted Shares; the Restricted Period, if any, applicable to Restricted Shares; the Performance

[Table of Contents](#)

Goals (if any) applicable to Restricted Shares; and all other conditions of the Restricted Shares. If the restrictions, Performance Goals and/or conditions established by the Administrator are not attained, a Participant shall forfeit his or her Restricted Shares in accordance with the terms of the grant. The terms and conditions applicable to the Restricted Shares need not be the same with respect to each Participant.

(b) *Awards and Certificates*. The prospective recipient of Restricted Shares shall not have any rights with respect to any such Award, unless and until such recipient has received an Award Agreement and, if required by the Administrator in the Award Agreement, executed and delivered a fully executed copy thereof to the Company, within a period of sixty (60) days (or such other period as the Administrator may specify) after the award date. Except as otherwise provided in herein, (i) each Participant who is granted an Award of Restricted Shares may, in the Company's sole discretion, be issued a stock certificate in respect of such Restricted Shares; and (ii) any such certificate so issued shall be registered in the name of the Participant, and shall bear an appropriate legend referring to the terms, conditions, and restrictions applicable to any such Award. The Company may require that the stock certificates, if any, evidencing Restricted Shares granted hereunder be held in the custody of the Company until the restrictions thereon shall have lapsed, and that, as a condition of any award of Restricted Shares, the Participant shall have delivered a stock power, endorsed in blank, relating to the shares of Common Stock covered by such Award. Notwithstanding anything in the Plan to the contrary, any Restricted Shares (whether before or after any vesting conditions have been satisfied) may, in the Company's sole discretion, be issued in uncertificated form pursuant to the customary arrangements for issuing shares in such form.

(c) *Restrictions and Conditions*. The Restricted Shares granted pursuant to this Section 9 shall be subject to the following restrictions and conditions and any additional restrictions or conditions as determined by the Administrator at the time of grant or thereafter:

(i) The Restricted Shares shall be subject to the restrictions on transferability set forth in the Award Agreement and in the Plan.

(ii) The Administrator may, in its sole discretion, provide for the lapse of restrictions in installments and may accelerate or waive such restrictions in whole or in part based on such factors and such circumstances as the Administrator may determine, in its sole discretion, including, but not limited to, the attainment of certain Performance Goals, the Participant's termination of employment or service as Non-Employee Director or Consultant of the Company or an Affiliate thereof, or the Participant's death or Disability.

(iii) Subject to this Section 9(c)(iii), the Participant shall generally have the rights of a stockholder of the Company with respect to Restricted Shares during the Restricted Period. In the Administrator's discretion and as provided in the applicable Award Agreement, a Participant may be entitled to dividends or dividend equivalents on an Award of Restricted Shares, which will be payable in accordance with the terms of such grant as determined by the Administrator in accordance with Section 18 of the Plan. Certificates for unrestricted shares of Common Stock may, in the Company's sole discretion, be delivered to the Participant only after the Restricted Period has expired without forfeiture in respect of such Restricted Shares, except as the Administrator, in its sole discretion, shall otherwise determine.

(iv) The rights of Participants granted Restricted Shares upon termination of employment or service as a Non-Employee Director or Consultant of the Company or an Affiliate thereof terminates for any reason during the Restricted Period shall be set forth in the Award Agreement.

(d) *Change in Control*. Notwithstanding anything herein to the contrary, upon a Change in Control, all outstanding Restricted Shares shall be subject to Section 12 of the Plan.

Section 10. Restricted Stock Units.

(a) *General*. Restricted Stock Units may be issued either alone or in addition to other Awards granted under the Plan. The Administrator shall determine the Eligible Recipients to whom, and the time or times at which, grants of Restricted Stock Units shall be made; the number of Restricted Stock Units to be awarded; the Restricted Period, if any, applicable to Restricted Stock Units; the Performance Goals (if any) applicable to Restricted Stock Units; and all other conditions of the Restricted Stock Units. If the restrictions, Performance Goals and/or conditions established by the Administrator are not attained, a Participant shall forfeit his or her Restricted Stock Units in accordance with the terms of the grant. The provisions of Restricted Stock Units need not be the same with respect to each Participant.

[Table of Contents](#)

(b) *Award Agreement.* The prospective recipient of Restricted Stock Units shall not have any rights with respect to any such Award, unless and until such recipient has received an Award Agreement and, if required by the Administrator in the Award Agreement, executed and delivered a fully executed copy thereof to the Company, within a period of sixty (60) days (or such other period as the Administrator may specify) after the award date.

(c) *Restrictions and Conditions.* The Restricted Stock Units granted pursuant to this Section 10 shall be subject to the following restrictions and conditions and any additional restrictions or conditions as determined by the Administrator at the time of grant or, subject to Code Section 409A, thereafter:

(i) The Administrator may, in its sole discretion, provide for the lapse of restrictions in installments and may accelerate or waive such restrictions in whole or in part based on such factors and such circumstances as the Administrator may determine, in its sole discretion, including, but not limited to, the attainment of certain Performance Goals, the Participant's termination of employment or service as a Non-Employee Director or Consultant of the Company or an Affiliate thereof, or the Participant's death or Disability.

(ii) Participants holding Restricted Stock Units shall have no voting rights. A Restricted Stock Unit may, at the Administrator's discretion, carry with it a right to dividend equivalents, subject to Section 18 of the Plan. Such right would entitle the holder to be credited with an amount equal to all cash dividends paid on one Share while the Restricted Stock Unit is outstanding. The Administrator, in its discretion, may grant dividend equivalents from the date of grant or only after a Restricted Stock Unit is vested.

(iii) The rights of Participants granted Restricted Stock Units upon termination of employment or service as a Non-Employee Director or Consultant of the Company or an Affiliate thereof terminates for any reason during the Restricted Period shall be set forth in the Award Agreement.

(d) *Settlement of Restricted Stock Units.* Settlement of vested Restricted Stock Units shall be made to Participants in the form of shares of Common Stock, unless the Administrator, in its sole discretion, provides for the payment of the Restricted Stock Units in cash (or partly in cash and partly in shares of Common Stock) equal to the value of the shares of Common Stock that would otherwise be distributed to the Participant.

(e) *Change in Control.* Notwithstanding anything herein to the contrary, upon a Change in Control, all outstanding Restricted Stock Units shall be subject to Section 12 of the Plan.

Section 11. Other Share-Based or Cash-Based Awards.

(a) The Administrator is authorized to grant Awards to Participants in the form of Other Share-Based Awards or Other Cash-Based Awards, as deemed by the Administrator to be consistent with the purposes of the Plan and as evidenced by an Award Agreement. The Administrator shall determine the terms and conditions of such Awards, consistent with the terms of the Plan, at the date of grant or thereafter, including any Performance Goals and performance periods. Shares of Common Stock or other securities or property delivered pursuant to an Award in the nature of a purchase right granted under this Section 11 shall be purchased for such consideration, paid for at such times, by such methods, and in such forms, including, without limitation, shares of Common Stock, other Awards, notes or other property, as the Administrator shall determine, subject to any required corporate action.

(b) The prospective recipient of an Other Share-Based Award or Other Cash-Based Award shall not have any rights with respect to such Award, unless and until such recipient has received an Award Agreement and, if required by the Administrator in the Award Agreement, executed and delivered a fully executed copy thereof to the Company, within a period of sixty (60) days (or such other period as the Administrator may specify) after the award date.

(c) Notwithstanding anything herein to the contrary, upon a Change in Control, all outstanding Other Share-Based Awards and Other Cash-Based Awards shall be subject to Section 12 of the Plan.

Section 12. Change in Control.

The Administrator may provide in the applicable Award Agreement that an Award will vest on an accelerated basis upon the Participant's termination of employment or service in connection with a Change in Control or upon the occurrence of any other event that the Administrator may set forth in the Award Agreement. If the Company is a party to an agreement that is reasonably likely to result in a Change in Control, such agreement may provide for: (i) the continuation of any Award by the Company, if the Company is the surviving corporation; (ii) the assumption of any Award by the surviving corporation or its parent or subsidiary; (iii) the substitution by the surviving corporation or its

parent or subsidiary of equivalent awards for any Award, *provided, however*, that any such substitution with respect to Options and Stock Appreciation Rights shall occur in accordance with the requirements of Code Section 409A; or (iv) settlement of any Award for the Change in Control Price (less, to the extent applicable, the per share exercise or grant price), or, if the per share exercise or grant price equals or exceeds the Change in Control Price or if the Administrator determines that Award cannot reasonably become vested pursuant to its terms, such Award shall terminate and be canceled without consideration. To the extent that Restricted Shares, Restricted Stock Units or other Awards settle in shares of Common Stock in accordance with their terms upon a Change in Control, such shares of Common Stock shall be entitled to receive as a result of the Change in Control transaction the same consideration as the shares of Common Stock held by stockholders of the Company as a result of the Change in Control transaction. For purposes of this Section 12, “Change in Control Price” shall mean (A) the price per Share paid to stockholders of the Company in the Change in Control transaction, or (B) the Fair Market Value of a Share upon a Change in Control, as determined by the Administrator. To the extent that the consideration paid in any such Change in Control transaction consists all or in part of securities or other non-cash consideration, the value of such securities or other non-cash consideration shall be determined in good faith by the Administrator.

Section 13. Amendment and Termination.

(a) The Board or the Committee may amend, alter or terminate the Plan, but no amendment, alteration, or termination shall be made that would adversely alter or impair the rights of a Participant under any Award heretofore granted without such Participant’s prior written consent.

(b) Notwithstanding the foregoing, (i) approval of the Company’s stockholders shall be obtained for any amendment that would require such approval in order to satisfy the requirements of Code Section 422, if applicable, any rules of the stock exchange on which the shares of Common Stock are traded or other applicable law, and (ii) without stockholder approval to the extent required by the rules of any applicable national securities exchange or inter-dealer quotation system on which the shares of Common Stock are listed or quoted, except as otherwise permitted under Section 5 of the Plan, (A) no amendment or modification may reduce the Exercise Price of any Option or Stock Appreciation Right, (B) the Administrator may not cancel any outstanding Option or Stock Appreciation Right and replace it with a new Option or Stock Appreciation Right, another Award or cash and (C) the Administrator may not take any other action that is considered a “repricing” for purposes of the stockholder approval rules of the applicable securities exchange or inter-dealer quotation system.

(c) Subject to the terms and conditions of the Plan and Code Section 409A, the Administrator may modify, extend or renew outstanding Awards under the Plan, or accept the surrender of outstanding Awards (to the extent not already exercised) and grant new Awards in substitution of them (to the extent not already exercised).

(d) Notwithstanding the foregoing, no alteration, modification or termination of an Award will, without the prior written consent of the Participant, adversely alter or impair any rights or obligations under any Award already granted under the Plan.

Section 14. Unfunded Status of Plan.

The Plan is intended to constitute an “unfunded” plan for incentive compensation. Neither the Company, the Board nor the Committee shall be required to establish any special or separate fund or to segregate any assets to assure the performance of its obligations under the Plan. With respect to any payments not yet made or shares of Common Stock not yet transferred to a Participant by the Company, nothing contained herein shall give any such Participant any rights that are greater than those of a general unsecured creditor of the Company.

Section 15. Deferrals of Payment.

To the extent permitted by applicable law, the Administrator, in its sole discretion, may determine that the delivery of shares of Common Stock or the payment of cash, upon the exercise, vesting or settlement of all or a portion of any Award, shall be deferred. The Administrator may also, in its sole discretion, establish one or more programs under the Plan to permit selected Participants the opportunity to elect to defer receipt of any such consideration, including any applicable election procedures, the timing of such elections, the mechanisms for payments of amounts, shares or other consideration so deferred, and such other terms, conditions, rules and procedures that the Administrator deems advisable for the administration of any such deferral program. Deferrals by Participants (or deferred settlement or payment required by the Administrator) shall be made in accordance with Code Section 409A, if applicable, and any other applicable law.

Section 16. Withholding Taxes.

Each Participant shall, no later than the date as of which the value of an Award first becomes includible in the gross income of such Participant for federal, state and/or local income tax purposes, pay to the Company, or make arrangements satisfactory to the Administrator regarding payment of, any federal, state, or local taxes of any kind, domestic or foreign, required by law or regulation to be withheld with respect to the Award. The obligations of the Company under the Plan shall be conditional on the making of such payments or arrangements, and the Company shall, to the extent permitted by law, have the right to deduct any such taxes from any payment of any kind otherwise due to such Participant. Whenever cash is to be paid pursuant to an Award granted hereunder, the Company shall have the right to deduct therefrom an amount sufficient to satisfy any federal, state and local withholding tax requirements related thereto. Whenever shares of Common Stock are to be delivered pursuant to an Award, the Company shall have the right to require the Participant to remit to the Company in cash an amount sufficient to satisfy any related federal, state and local taxes, domestic or foreign, to be withheld and applied to the tax obligations. With the approval of the Administrator, a Participant may satisfy the foregoing requirement by electing to have the Company withhold from delivery of shares of Common Stock or by delivering already owned unrestricted shares of Common Stock, in each case, having a value equal to the amount required to be withheld or other greater amount not exceeding the maximum statutory rate required to be collected on the transaction under applicable law, as applicable to the Participant, if such other greater amount would not, as determined by the Administrator, result in adverse financial accounting treatment (including in connection with the effectiveness of FASB Accounting Standards Update 2016-09). Such shares of Common Stock shall be valued at their Fair Market Value on the date of which the amount of tax to be withheld is determined. Fractional share amounts shall be settled in cash. Such an election may be made with respect to all or any portion of the shares of Common Stock to be delivered pursuant to an Award. The Company may also use any other method of obtaining the necessary payment or proceeds, as permitted by law, to satisfy its withholding obligation with respect to any Option or other Award.

Section 17. Certain Forfeitures.

The Administrator may specify in an Award Agreement that the Participant's rights, payments and benefits with respect to an Award shall be subject to reduction, cancellation, forfeiture or recoupment upon the occurrence of certain events, in addition to the applicable vesting conditions of an Award. Such events may include, without limitation, breach of any non-competition, non-solicitation, confidentiality, or other restrictive covenants that are contained in an Award Agreement or that are otherwise applicable to the Participant, a termination of the Participant's employment for Cause, or other conduct by the Participant that is detrimental to the business or reputation of the Company and its Subsidiaries and/or its Affiliates.

Section 18. Dividends; Dividend Equivalents.

Notwithstanding anything in this Plan to the contrary, to the extent that an Award contains a right to receive dividends or dividend equivalents while such Award remains unvested, such dividends or dividend equivalents will be accumulated and paid once and to the extent that the underlying Award vests.

Section 19. Non-United States Employees.

Without amending the Plan, the Administrator may grant Awards to eligible persons residing in non-United States jurisdictions on such terms and conditions different from those specified in the Plan, including the terms of any award agreement or plan, adopted by the Company or any Subsidiary thereof to comply with, or take advantage of favorable tax or other treatment available under, the laws of any non-United States jurisdiction, as may in the judgment of the Administrator be necessary or desirable to foster and promote achievement of the purposes of the Plan and, in furtherance of such purposes the Administrator may make such modifications, amendments, procedures, sub-plans and the like as may be necessary or advisable to comply with provisions of laws in other countries or jurisdictions in which the Company or its Subsidiaries operates or has employees.

Section 20. Transfer of Awards.

No purported sale, assignment, mortgage, hypothecation, transfer, charge, pledge, encumbrance, gift, transfer in trust (voting or other) or other disposition of, or creation of a security interest in or lien on, any Award or any agreement or commitment to do any of the foregoing (each, a "Transfer") by any holder thereof in violation of the provisions of the Plan or an Award Agreement will be valid, except with the prior written consent of the Administrator, which consent may be granted or withheld in the sole discretion of the Administrator, and other than by will or by

the laws of descent and distribution. Any purported Transfer of an Award or any economic benefit or interest therein in violation of the Plan or an Award Agreement shall be null and void *ab initio*, and shall not create any obligation or liability of the Company, and any person purportedly acquiring any Award or any economic benefit or interest therein transferred in violation of the Plan or an Award Agreement shall not be entitled to be recognized as a holder of such shares of Common Stock. Unless otherwise determined by the Administrator in accordance with the provisions of the immediately preceding sentence, an Option may be exercised, during the lifetime of the Participant, only by the Participant or, during any period during which the Participant is under a legal disability, by the Participant's guardian or legal representative. Under no circumstances will a Participant be permitted to transfer an Option or Stock Appreciation Right to a third-party financial institution without prior stockholder approval.

Section 21. Continued Employment.

The adoption of the Plan shall not confer upon any Eligible Recipient any right to continued employment or service with the Company or an Affiliate thereof, as the case may be, nor shall it interfere in any way with the right of the Company or an Affiliate thereof to terminate the employment or service of any of its Eligible Recipients at any time.

Section 22. Effective Date.

The Plan will be effective as of the date of consummation of the transactions contemplated by the Merger Agreement so long as the Plan has been approved by the Company's stockholders. The Plan will be unlimited in duration and, in the event of Plan termination, will remain in effect as long as any shares of Common Stock awarded under it are outstanding and not fully vested; *provided, however*, that no Awards will be made under the Plan on or after the tenth anniversary of the Effective Date; *provided further*, that in no event may an Incentive Stock Option be granted more than ten years after the earlier of (a) the date of the adoption of the Plan by the Board or (b) the Effective Date.

Section 23. Code Section 409A.

The intent of the parties is that payments and benefits under the Plan be either exempt from Code Section 409A or comply with Code Section 409A to the extent subject thereto, and, accordingly, to the maximum extent permitted, the Plan shall be interpreted and be administered consistent with such intent. Any payments described in the Plan that are due within the "short-term deferral period" as defined in Code Section 409A shall not be treated as deferred compensation unless applicable law requires otherwise. Notwithstanding anything to the contrary in the Plan, to the extent required in order to avoid accelerated taxation and/or tax penalties under Code Section 409A, amounts that would otherwise be payable and benefits that would otherwise be provided upon a "separation from service" to a Participant who is a "specified employee" shall be paid on the first business day after the date that is six (6) months following the Participant's separation from service (or upon the Participant's death, if earlier). In addition, for purposes of the Plan, each amount to be paid or benefit to be provided to the Participant pursuant to the Plan, which constitute deferred compensation subject to Code Section 409A, shall be construed as a separate identified payment for purposes of Code Section 409A. Nothing contained in the Plan or an Award Agreement shall be construed as a guarantee of any particular tax effect with respect to an Award. The Company does not guarantee that any Awards provided under the Plan will be exempt from or in compliance with the provisions of Code Section 409A, and in no event will the Company be liable for any or all portion of any taxes, penalties, interest or other expenses that may be incurred by a Participant on account of any Award being subject to, but not in compliance with, Code Section 409A.

Section 24. Compliance with Laws.

(a) The obligation of the Company to settle Awards in shares of Common Stock or other consideration shall be subject to (i) all applicable laws, rules, and regulations, (ii) such approvals as may be required by governmental agencies or the applicable national securities exchange on which the shares of Common Stock may be admitted, and (iii) policies maintained by the Company from time to time in order to comply with applicable laws, rules, regulations and corporate governance requirements, including, without limitation, with respect to insider trading restrictions. Notwithstanding any terms or conditions of any Award to the contrary, the Company shall be under no obligation to offer to sell or to sell, and shall be prohibited from offering to sell or selling, any shares of Common Stock pursuant to an Award unless such shares have been properly registered for sale pursuant to the Securities Act with the Securities and Exchange Commission or unless the Company has received an opinion of counsel (if the Company has requested

such an opinion), satisfactory to the Company, that such shares of Common Stock may be offered or sold without such registration pursuant to an available exemption therefrom and the terms and conditions of such exemption have been fully complied with. The Company shall be under no obligation to register for sale under the Securities Act any of the shares of Common Stock to be offered or sold under the Plan. The Administrator shall have the authority to provide that all shares of Common Stock or other securities of the Company issued under the Plan shall be subject to such stop transfer orders and other restrictions as the Committee may deem advisable under the Plan, the applicable Award Agreement, the federal securities laws, or the rules, regulations and other requirements of the Securities and Exchange Commission, any securities exchange or inter-dealer quotation system on which the securities of the Company are listed or quoted and any other applicable federal, state, local or non-U.S. laws, rules, regulations and other requirements, and the Administrator may cause a legend or legends to be put on certificates representing shares of Common Stock or other securities of the Company issued under the Plan to make appropriate reference to such restrictions or may cause such shares of Common Stock or other securities of the Company issued under the Plan in book-entry form to be held subject to the Company's instructions or subject to appropriate stop-transfer orders. Notwithstanding any provision in the Plan to the contrary, the Committee reserves the right to add any additional terms or provisions to any Award granted under the Plan that it, in its sole discretion, deems necessary or advisable in order that such Award complies with the legal requirements of any governmental entity to whose jurisdiction the Award is subject.

(b) The Administrator may cancel an Award or any portion thereof if it determines, in its sole discretion, that legal or contractual restrictions and/or blockage and/or other market considerations would make the Company's acquisition of shares of Common Stock from the public markets, the Company's issuance of shares of Common Stock to the Participant, the Participant's acquisition of shares of Common Stock from the Company and/or the Participant's sale of shares of Common Stock to the public markets, illegal, impracticable or inadvisable. If the Administrator determines to cancel all or any portion of an Award in accordance with the foregoing, the Company shall, subject to any limitations or reductions as may be necessary to comply with Code Section 409A, (i) pay to the Participant an amount equal to the excess of (A) the aggregate Fair Market Value of the shares of Common Stock subject to such Award or portion thereof canceled (determined as of the applicable exercise date, or the date that the shares of Common Stock would have been vested or issued, as applicable), over (B) the aggregate Exercise Price (in the case of an Option or Stock Appreciation Right) or any amount payable as a condition of issuance of shares of Common Stock (in the case of any other Award), and such amount shall be delivered to the Participant as soon as practicable following the cancellation of such Award or portion thereof, or (ii) in the case of Restricted Shares, Restricted Stock Units or Other Share-Based Awards, provide the Participant with a cash payment or equity subject to deferred vesting and delivery consistent with the vesting restrictions applicable to such Restricted Shares, Restricted Stock Units or Other Share-Based Awards, or the underlying shares of Common Stock in respect thereof.

Section 25. Clawback/Recovery.

The Plan and all Awards issued hereunder shall be subject to any compensation recovery and/or recoupment policy adopted by the Company to comply with applicable law, including, without limitation, the Dodd-Frank Wall Street Reform and Consumer Protection Act, or to comport with good corporate governance practices, as such policies may be amended from time to time. No recovery of compensation under such a clawback policy will be an event giving rise to a right to resign for "good reason" or "constructive termination" (or similar term) under any agreement with the Company or a Subsidiary.

Section 26. Governing Law.

The Plan shall be governed by and construed in accordance with the laws of the State of Delaware, without giving effect to principles of conflicts of law of such state.

Section 27. Plan Document Controls.

The Plan and each Award Agreement together constitute the entire agreement with respect to the subject matter hereof and thereof; *provided*, that in the event of any inconsistency between the Plan and such Award Agreement, the terms and conditions of the Plan shall control.

SECTION 262 APPRAISAL RIGHTS

§ 262. Appraisal rights

(a) Any stockholder of a corporation of this State who holds shares of stock on the date of the making of a demand pursuant to subsection (d) of this section with respect to such shares, who continuously holds such shares through the effective date of the merger or consolidation, who has otherwise complied with subsection (d) of this section and who has neither voted in favor of the merger or consolidation nor consented thereto in writing pursuant to § 228 of this title shall be entitled to an appraisal by the Court of Chancery of the fair value of the stockholder's shares of stock under the circumstances described in subsections (b) and (c) of this section. As used in this section, the word "stockholder" means a holder of record of stock in a corporation; the words "stock" and "share" mean and include what is ordinarily meant by those words; and the words "depository receipt" mean a receipt or other instrument issued by a depository representing an interest in 1 or more shares, or fractions thereof, solely of stock of a corporation, which stock is deposited with the depository.

(b) Appraisal rights shall be available for the shares of any class or series of stock of a constituent corporation in a merger or consolidation to be effected pursuant to § 251 (other than a merger effected pursuant to § 251(g) of this title), § 252, § 254, § 255, § 256, § 257, § 258, § 263 or § 264 of this title:

(1) Provided, however, that no appraisal rights under this section shall be available for the shares of any class or series of stock, which stock, or depository receipts in respect thereof, at the record date fixed to determine the stockholders entitled to receive notice of the meeting of stockholders to act upon the agreement of merger or consolidation (or, in the case of a merger pursuant to § 251(h), as of immediately prior to the execution of the agreement of merger), were either: (i) listed on a national securities exchange or (ii) held of record by more than 2,000 holders; and further provided that no appraisal rights shall be available for any shares of stock of the constituent corporation surviving a merger if the merger did not require for its approval the vote of the stockholders of the surviving corporation as provided in § 251(f) of this title.

(2) Notwithstanding paragraph (b)(1) of this section, appraisal rights under this section shall be available for the shares of any class or series of stock of a constituent corporation if the holders thereof are required by the terms of an agreement of merger or consolidation pursuant to §§ 251, 252, 254, 255, 256, 257, 258, 263 and 264 of this title to accept for such stock anything except:

a. Shares of stock of the corporation surviving or resulting from such merger or consolidation, or depository receipts in respect thereof;

b. Shares of stock of any other corporation, or depository receipts in respect thereof, which shares of stock (or depository receipts in respect thereof) or depository receipts at the effective date of the merger or consolidation will be either listed on a national securities exchange or held of record by more than 2,000 holders;

c. Cash in lieu of fractional shares or fractional depository receipts described in the foregoing paragraphs (b)(2)a. and b. of this section; or

d. Any combination of the shares of stock, depository receipts and cash in lieu of fractional shares or fractional depository receipts described in the foregoing paragraphs (b)(2)a., b. and c. of this section.

(3) In the event all of the stock of a subsidiary Delaware corporation party to a merger effected under § 253 or § 267 of this title is not owned by the parent immediately prior to the merger, appraisal rights shall be available for the shares of the subsidiary Delaware corporation.

(4) [Repealed.]

(c) Any corporation may provide in its certificate of incorporation that appraisal rights under this section shall be available for the shares of any class or series of its stock as a result of an amendment to its certificate of incorporation, any merger or consolidation in which the corporation is a constituent corporation or the sale of all or substantially all of the assets of the corporation. If the certificate of incorporation contains such a provision, the provisions of this section, including those set forth in subsections (d),(e), and (g) of this section, shall apply as nearly as is practicable.

(d) Appraisal rights shall be perfected as follows:

(1) If a proposed merger or consolidation for which appraisal rights are provided under this section is to be submitted for approval at a meeting of stockholders, the corporation, not less than 20 days prior to the meeting, shall notify each of its stockholders who was such on the record date for notice of such meeting (or such members who received notice in accordance with § 255(c) of this title) with respect to shares for which appraisal rights are available pursuant to subsection (b) or (c) of this section that appraisal rights are available for any or all of the shares of the constituent corporations, and shall include in such notice a copy of this section and, if 1 of the constituent corporations is a nonstock corporation, a copy of § 114 of this title. Each stockholder electing to demand the appraisal of such stockholder's shares shall deliver to the corporation, before the taking of the vote on the merger or consolidation, a written demand for appraisal of such stockholder's shares; provided that a demand may be delivered to the corporation by electronic transmission if directed to an information processing system (if any) expressly designated for that purpose in such notice. Such demand will be sufficient if it reasonably informs the corporation of the identity of the stockholder and that the stockholder intends thereby to demand the appraisal of such stockholder's shares. A proxy or vote against the merger or consolidation shall not constitute such a demand. A stockholder electing to take such action must do so by a separate written demand as herein provided. Within 10 days after the effective date of such merger or consolidation, the surviving or resulting corporation shall notify each stockholder of each constituent corporation who has complied with this subsection and has not voted in favor of or consented to the merger or consolidation of the date that the merger or consolidation has become effective; or

(2) If the merger or consolidation was approved pursuant to § 228, § 251(h), § 253, or § 267 of this title, then either a constituent corporation before the effective date of the merger or consolidation or the surviving or resulting corporation within 10 days thereafter shall notify each of the holders of any class or series of stock of such constituent corporation who are entitled to appraisal rights of the approval of the merger or consolidation and that appraisal rights are available for any or all shares of such class or series of stock of such constituent corporation, and shall include in such notice a copy of this section and, if 1 of the constituent corporations is a nonstock corporation, a copy of § 114 of this title. Such notice may, and, if given on or after the effective date of the merger or consolidation, shall, also notify such stockholders of the effective date of the merger or consolidation. Any stockholder entitled to appraisal rights may, within 20 days after the date of giving such notice or, in the case of a merger approved pursuant to § 251(h) of this title, within the later of the consummation of the offer contemplated by § 251(h) of this title and 20 days after the date of giving such notice, demand in writing from the surviving or resulting corporation the appraisal of such holder's shares; provided that a demand may be delivered to the corporation by electronic transmission if directed to an information processing system (if any) expressly designated for that purpose in such notice. Such demand will be sufficient if it reasonably informs the corporation of the identity of the stockholder and that the stockholder intends thereby to demand the appraisal of such holder's shares. If such notice did not notify stockholders of the effective date of the merger or consolidation, either (i) each such constituent corporation shall send a second notice before the effective date of the merger or consolidation notifying each of the holders of any class or series of stock of such constituent corporation that are entitled to appraisal rights of the effective date of the merger or consolidation or (ii) the surviving or resulting corporation shall send such a second notice to all such holders on or within 10 days after such effective date; provided, however, that if such second notice is sent more than 20 days following the sending of the first notice or, in the case of a merger approved pursuant to § 251(h) of this title, later than the later of the consummation of the offer contemplated by § 251(h) of this title and 20 days following the sending of the first notice, such second notice need only be sent to each stockholder who is entitled to appraisal rights and who has demanded appraisal of such holder's shares in accordance with this subsection. An affidavit of the secretary or assistant secretary or of the transfer agent of the corporation that is required to give either notice that such notice has been given shall, in the absence of fraud, be prima facie evidence of the facts stated therein. For purposes of determining the stockholders entitled to receive either notice, each constituent corporation may fix, in advance, a record date that shall be not more than 10 days prior to the date the notice is given, provided, that if the notice is given on or after the effective date of the merger or consolidation, the record date shall be such effective date. If no record date is fixed and the notice is given prior to the effective date, the record date shall be the close of business on the day next preceding the day on which the notice is given.

(e) Within 120 days after the effective date of the merger or consolidation, the surviving or resulting corporation or any stockholder who has complied with subsections (a) and (d) of this section hereof and who is otherwise entitled to appraisal rights, may commence an appraisal proceeding by filing a petition in the Court of Chancery demanding a determination of the value of the stock of all such stockholders. Notwithstanding the foregoing, at any time within 60 days after the effective date of the merger or consolidation, any stockholder who has not commenced an appraisal proceeding or joined that proceeding as a named party shall have the right to withdraw such stockholder's demand

[Table of Contents](#)

for appraisal and to accept the terms offered upon the merger or consolidation. Within 120 days after the effective date of the merger or consolidation, any stockholder who has complied with the requirements of subsections (a) and (d) of this section hereof, upon request given in writing (or by electronic transmission directed to an information processing system (if any) expressly designated for that purpose in the notice of appraisal), shall be entitled to receive from the corporation surviving the merger or resulting from the consolidation a statement setting forth the aggregate number of shares not voted in favor of the merger or consolidation (or, in the case of a merger approved pursuant to § 251(h) of this title, the aggregate number of shares (other than any excluded stock (as defined in § 251(h)(6)d. of this title)) that were the subject of, and were not tendered into, and accepted for purchase or exchange in, the offer referred to in § 251(h)(2)), and, in either case, with respect to which demands for appraisal have been received and the aggregate number of holders of such shares. Such statement shall be given to the stockholder within 10 days after such stockholder's request for such a statement is received by the surviving or resulting corporation or within 10 days after expiration of the period for delivery of demands for appraisal under subsection (d) of this section hereof, whichever is later. Notwithstanding subsection (a) of this section, a person who is the beneficial owner of shares of such stock held either in a voting trust or by a nominee on behalf of such person may, in such person's own name, file a petition or request from the corporation the statement described in this subsection.

(f) Upon the filing of any such petition by a stockholder, service of a copy thereof shall be made upon the surviving or resulting corporation, which shall within 20 days after such service file in the office of the Register in Chancery in which the petition was filed a duly verified list containing the names and addresses of all stockholders who have demanded payment for their shares and with whom agreements as to the value of their shares have not been reached by the surviving or resulting corporation. If the petition shall be filed by the surviving or resulting corporation, the petition shall be accompanied by such a duly verified list. The Register in Chancery, if so ordered by the Court, shall give notice of the time and place fixed for the hearing of such petition by registered or certified mail to the surviving or resulting corporation and to the stockholders shown on the list at the addresses therein stated. Such notice shall also be given by 1 or more publications at least 1 week before the day of the hearing, in a newspaper of general circulation published in the City of Wilmington, Delaware or such publication as the Court deems advisable. The forms of the notices by mail and by publication shall be approved by the Court, and the costs thereof shall be borne by the surviving or resulting corporation.

(g) At the hearing on such petition, the Court shall determine the stockholders who have complied with this section and who have become entitled to appraisal rights. The Court may require the stockholders who have demanded an appraisal for their shares and who hold stock represented by certificates to submit their certificates of stock to the Register in Chancery for notation thereon of the pendency of the appraisal proceedings; and if any stockholder fails to comply with such direction, the Court may dismiss the proceedings as to such stockholder. If immediately before the merger or consolidation the shares of the class or series of stock of the constituent corporation as to which appraisal rights are available were listed on a national securities exchange, the Court shall dismiss the proceedings as to all holders of such shares who are otherwise entitled to appraisal rights unless (1) the total number of shares entitled to appraisal exceeds 1% of the outstanding shares of the class or series eligible for appraisal, (2) the value of the consideration provided in the merger or consolidation for such total number of shares exceeds \$1 million, or (3) the merger was approved pursuant to § 253 or § 267 of this title.

(h) After the Court determines the stockholders entitled to an appraisal, the appraisal proceeding shall be conducted in accordance with the rules of the Court of Chancery, including any rules specifically governing appraisal proceedings. Through such proceeding the Court shall determine the fair value of the shares exclusive of any element of value arising from the accomplishment or expectation of the merger or consolidation, together with interest, if any, to be paid upon the amount determined to be the fair value. In determining such fair value, the Court shall take into account all relevant factors. Unless the Court in its discretion determines otherwise for good cause shown, and except as provided in this subsection, interest from the effective date of the merger through the date of payment of the judgment shall be compounded quarterly and shall accrue at 5% over the Federal Reserve discount rate (including any surcharge) as established from time to time during the period between the effective date of the merger and the date of payment of the judgment. At any time before the entry of judgment in the proceedings, the surviving corporation may pay to each stockholder entitled to appraisal an amount in cash, in which case interest shall accrue thereafter as provided herein only upon the sum of (1) the difference, if any, between the amount so paid and the fair value of the shares as determined by the Court, and (2) interest theretofore accrued, unless paid at that time. Upon application by the surviving or resulting corporation or by any stockholder entitled to participate in the appraisal proceeding, the Court may, in its discretion, proceed to trial upon the appraisal prior to the final determination of the stockholders entitled to an appraisal. Any stockholder whose name appears on the list filed by the surviving or resulting corporation pursuant

[Table of Contents](#)

to subsection (f) of this section and who has submitted such stockholder's certificates of stock to the Register in Chancery, if such is required, may participate fully in all proceedings until it is finally determined that such stockholder is not entitled to appraisal rights under this section.

(i) The Court shall direct the payment of the fair value of the shares, together with interest, if any, by the surviving or resulting corporation to the stockholders entitled thereto. Payment shall be so made to each such stockholder, in the case of holders of uncertificated stock forthwith, and the case of holders of shares represented by certificates upon the surrender to the corporation of the certificates representing such stock. The Court's decree may be enforced as other decrees in the Court of Chancery may be enforced, whether such surviving or resulting corporation be a corporation of this State or of any state.

(j) The costs of the proceeding may be determined by the Court and taxed upon the parties as the Court deems equitable in the circumstances. Upon application of a stockholder, the Court may order all or a portion of the expenses incurred by any stockholder in connection with the appraisal proceeding, including, without limitation, reasonable attorney's fees and the fees and expenses of experts, to be charged pro rata against the value of all the shares entitled to an appraisal.

(k) From and after the effective date of the merger or consolidation, no stockholder who has demanded appraisal rights as provided in subsection (d) of this section shall be entitled to vote such stock for any purpose or to receive payment of dividends or other distributions on the stock (except dividends or other distributions payable to stockholders of record at a date which is prior to the effective date of the merger or consolidation); provided, however, that if no petition for an appraisal shall be filed within the time provided in subsection (e) of this section, or if such stockholder shall deliver to the surviving or resulting corporation a written withdrawal of such stockholder's demand for an appraisal and an acceptance of the merger or consolidation, either within 60 days after the effective date of the merger or consolidation as provided in subsection (e) of this section or thereafter with the written approval of the corporation, then the right of such stockholder to an appraisal shall cease. Notwithstanding the foregoing, no appraisal proceeding in the Court of Chancery shall be dismissed as to any stockholder without the approval of the Court, and such approval may be conditioned upon such terms as the Court deems just; provided, however that this provision shall not affect the right of any stockholder who has not commenced an appraisal proceeding or joined that proceeding as a named party to withdraw such stockholder's demand for appraisal and to accept the terms offered upon the merger or consolidation within 60 days after the effective date of the merger or consolidation, as set forth in subsection (e) of this section.

(l) The shares of the surviving or resulting corporation to which the shares of such objecting stockholders would have been converted had they assented to the merger or consolidation shall have the status of authorized and unissued shares of the surviving or resulting corporation.

8 Del. C. 1953, § 262; 56 Del. Laws, c. 50; 56 Del. Laws, c. 186, § 24; 57 Del. Laws, c. 148, §§ 27-29; 59 Del. Laws, c. 106, § 12; 60 Del. Laws, c. 371, §§ 3-12; 63 Del. Laws, c. 25, § 14; 63 Del. Laws, c. 152, §§ 1, 2; 64 Del. Laws, c. 112, §§ 46-54; 66 Del. Laws, c. 136, §§ 30-32; 66 Del. Laws, c. 352, § 9; 67 Del. Laws, c. 376, §§ 19, 20; 68 Del. Laws, c. 337, §§ 3, 4; 69 Del. Laws, c. 61, § 10; 69 Del. Laws, c. 262, §§ 1-9; 70 Del. Laws, c. 79, § 16; 70 Del. Laws, c. 186, § 1; 70 Del. Laws, c. 299, §§ 2, 3; 70 Del. Laws, c. 349, § 22; 71 Del. Laws, c. 120, § 15; 71 Del. Laws, c. 339, §§ 49-52; 73 Del. Laws, c. 82, § 21; 76 Del. Laws, c. 145, §§ 11-16; 77 Del. Laws, c. 14, §§ 12, 13; 77 Del. Laws, c. 253, §§ 47-50; 77 Del. Laws, c. 290, §§ 16, 17; 79 Del. Laws, c. 72, §§ 10, 11; 79 Del. Laws, c. 122, §§ 6, 7; 80 Del. Laws, c. 265, §§ 8-11; 81 Del. Laws, c. 354, §§ 9, 10, 17; 82 Del. Laws, c. 45, § 15; 82 Del. Laws, c. 256, § 15;



March 24, 2022

Board of Directors
CleanTech Acquisition Corp.
207 West 25th Street, 9th Floor
New York, New York 10001

Dear Members of the Board of Directors:

CleanTech Acquisition Corp., a Delaware corporation ("CLAQ"), has engaged Kroll, LLC ("Duff & Phelps"), operating through its Duff & Phelps Opinions Practice, to serve as an independent financial advisor to the Board of Directors (the "Board of Directors") of CLAQ (solely in their capacity as members of the Board of Directors) in connection with the Business Combination (as defined below). On December 16, 2021, CLAQ entered into an Agreement and Plan of Merger (as amended on January 30, 2022, the "Merger Agreement") and together with the other agreements and transactions contemplated by the Merger Agreement, the "Business Combination") with CleanTech Merger Sub, Inc., a Delaware corporation and a wholly owned subsidiary of CLAQ ("Merger Sub"), and Nauticus Robotics, Inc., a Texas corporation ("Nauticus"). Pursuant to the terms of the Merger Agreement, a business combination between CLAQ and Nauticus will be effected through the merger of Merger Sub with and into Nauticus, with Nauticus surviving the merger as a wholly owned subsidiary of CLAQ (the "Merger").

In addition, in connection with the consummation of the Merger, CLAQ will be renamed "Nauticus Robotics, Inc." and the current Nauticus Robotics, Inc. will be renamed "Nauticus Robotics (Texas), Inc." The combined company after the Business Combination is referred to herein as the "Combined Company." Capitalized terms used but not defined herein have the meanings set forth in CLAQ's Form S-4 filed with the Securities and Exchange Commission ("SEC") on January 31, 2022 (the "CLAQ Form S-4").

Specifically, CLAQ has requested that Duff & Phelps provide the Board of Directors with a written opinion addressed to the Board of Directors as to whether, as of the date hereof, the consideration to be paid by CLAQ (in the form of CLAQ common stock, the "Consideration") to the Nauticus securityholders in such Business Combination pursuant to the Merger Agreement is fair to CLAQ, from a financial point of view (this "Opinion"). For the avoidance of doubt, Duff & Phelps did not analyze, and is not opining on, the fairness of the consideration as of December 16, 2021 or any date prior to the date of this Opinion.

Scope of Analysis

In connection with this Opinion, Duff & Phelps has made such reviews, analyses and inquiries as it has deemed necessary and appropriate under the circumstances to enable it to render this Opinion. Duff & Phelps also took into account its assessment of general economic, market and financial conditions, as well as its experience in securities and business valuation, in general, and with respect to similar transactions, in particular. Duff & Phelps' procedures, investigations, and financial analysis with respect to the preparation of this Opinion included, but were not limited to, the items summarized below:

1. Reviewed the following documents:
 - a. The Merger Agreement and the CLAQ S-4;
 - b. Unaudited financial information for Nauticus for the year ended December 31, 2021 and audited financial information for Nauticus for the year ended December 31, 2020;

kroll.com | Kroll, LLC
167 N. Green Street
Floor 12
Chicago, IL 60607

T: +1 312 697 4600
F: +1 312 697 0112

- c. Financial projections for the Combined Company for the calendar years 2022 through 2024, provided to us by management of Nauticus, approved for our use by management of CLAQ and included in the CLAQ S-4 (the “Financial Projections”); and
 - d. The Nauticus Investor Presentation dated December 2021;
2. Discussed the information referred to above and the background and other elements of the Business Combination with the management of CLAQ and certain members of the Board of Directors of CLAQ (in their capacity as members of the Board of Directors);
 3. Discussed with CLAQ management the plans and intentions with respect to the management and operation of Nauticus and CLAQ following the completion of the Business Combination;
 4. Discussed with CLAQ management and certain members of the Board of Directors of CLAQ (in their capacity as members of the Board of Directors) their assessment of the strategic rationale for, and the potential benefits of, the Business Combination;
 5. Performed certain valuation and comparative analyses using generally accepted valuation and analytical techniques, including a discounted cash flow analysis and an analysis of selected public companies that Duff & Phelps deemed relevant for comparison to Nauticus; and
 6. Conducted such other analyses and considered such other factors as Duff & Phelps deemed appropriate.

Assumptions, Qualifications and Limiting Conditions

In performing its analyses and rendering this Opinion with respect to the Business Combination, Duff & Phelps, with CLAQ’s consent:

1. Relied upon the accuracy, completeness, and fair presentation of all information, data, advice, opinions and representations obtained from public sources or provided to it from private sources, including CLAQ and Nauticus and their respective management, including all financial, legal, regulatory, tax, accounting and other information provided to, discussed with or reviewed by us, and did not independently verify such information;
2. Relied upon the fact that the Board of Directors and CLAQ have been advised by counsel as to all legal matters with respect to the Business Combination, including whether all procedures required by law to be taken in connection with the Business Combination have been duly, validly and timely taken;
3. Assumed that any estimates, evaluations, forecasts and projections and other pro forma information, including the Financial Projections, furnished to Duff & Phelps were reasonably prepared and based upon the best currently available information and good faith judgment of the person(s) furnishing the same, and Duff & Phelps expresses no opinion with respect to such estimates, evaluations, forecasts and projections and other pro forma information or any underlying assumptions;
4. Assumed that information supplied by and representations made by CLAQ and Nauticus and their respective management are substantially accurate regarding CLAQ, Nauticus and the Business Combination;
5. Assumed that the representations and warranties made in the Merger Agreement are substantially accurate;
6. Assumed that the final versions of all documents reviewed by Duff & Phelps in draft form conform in all material respects to the drafts reviewed;
7. Assumed that the PIPE Investment will occur as contemplated by the draft documents reviewed by Duff & Phelps and as described by management of Nauticus and CLAQ;

8. Assumed that there has been no material change in the assets, liabilities, financial condition, results of operations, business, or prospects of CLAQ or Nauticus since the date of the most recent financial statements and other information made available to Duff & Phelps, and that there is no information or facts that would make the information reviewed by Duff & Phelps incomplete or misleading;
9. Assumed that all of the conditions required to implement the Business Combination will be satisfied and that the Business Combination will be completed in a timely manner in accordance with the Merger Agreement without any material amendments thereto or any material waivers of any terms or conditions thereof; and
10. Assumed that the consummation of the Business Combination will comply in all respects with all applicable foreign, federal, state and local statutes, rules and regulations and that all governmental, regulatory or other consents and approvals necessary for the consummation of the Business Combination will be obtained without any adverse effect, that would be material to Duff & Phelps' analysis, on CLAQ, Nauticus, or the contemplated benefits expected to be derived in the Business Combination.

Given CLAQ's nature as a special purpose acquisition company, for purposes of this Opinion and its analysis and with CLAQ's consent, Duff & Phelps has assumed a value of \$10.00 per share for CLAQ's Common Stock, with such \$10.00 value being based on CLAQ's initial public offering and CLAQ's approximate cash per outstanding share of CLAQ Common Stock (excluding, for the avoidance of doubt, the dilutive impact of founder shares or any Public Warrants, Private Warrants or Rights). Further, for purposes of this Opinion and its analysis and with CLAQ's consent, Duff & Phelps has assumed the accuracy and completeness of the capitalization information for the Combined Company prepared by CLAQ, pro forma for the Business Combination and the PIPE Investment.

To the extent that any of the foregoing assumptions, representations or any of the facts on which this Opinion is based prove to be untrue in any material respect, this Opinion cannot and should not be relied upon. Furthermore, in Duff & Phelps' analysis and in connection with the preparation of this Opinion, Duff & Phelps has made numerous assumptions with respect to industry performance, general business, market and economic conditions and other matters, many of which are beyond the control of any party involved in the Business Combination.

Qualifications

Duff & Phelps has prepared this Opinion effective as of the date hereof. This Opinion is necessarily based upon market, economic, financial and other conditions as they exist and can be evaluated as of the date hereof, and Duff & Phelps disclaims any undertaking or obligation to advise any person of any change in any fact or matter affecting this Opinion which may come or be brought to the attention of Duff & Phelps after the date hereof.

Duff & Phelps did not evaluate the solvency of CLAQ or Nauticus or conduct an independent appraisal or physical inspection of any specific assets or liabilities (contingent, derivative, off-balance sheet or otherwise). Duff & Phelps has not been requested to, and did not, (i) initiate any discussions with, or solicit any indications of interest from, third parties with respect to the Business Combination, the assets, businesses or operations of CLAQ or any alternatives to the Business Combination, (ii) negotiate the terms of the Business Combination, and therefore, Duff & Phelps has assumed that such terms are the most beneficial terms, from CLAQ's perspective, that could, under the circumstances, be negotiated among the parties to the Merger Agreement and the Business Combination, or (iii) advise the Board of Directors or any other party with respect to alternatives to the Business Combination.

Duff & Phelps has assumed that the Merger will qualify, for US federal income tax purposes, as a "reorganization" within the meaning of Section 368(a) of the Internal Revenue Code of 1986, as amended. Duff & Phelps is not expressing any view or rendering any opinion regarding the tax consequences of the Merger to CLAQ, Nauticus, or their respective shareholders.

Duff & Phelps is not expressing any opinion as to the market price or value of CLAQ's Common Stock or the equity of Nauticus (or anything else) either before or after the consummation of the Business Combination or how any such shares may trade at any time. This Opinion should not be construed as a valuation opinion, credit rating, solvency opinion, an analysis of CLAQ's credit worthiness, as tax advice, or as accounting advice. Duff & Phelps has not made, and assumes no responsibility to make, any representation, or render any opinion, as to any legal matter.

In rendering this Opinion, Duff & Phelps is not expressing any opinion with respect to the amount or nature of any compensation to any of CLAQ's or Nauticus' officers, directors, or employees, or any class of such persons, relative to the Consideration, or with respect to the fairness of any such compensation.

Limiting Conditions

This Opinion is furnished for the use and benefit of the Board of Directors in connection with the Business Combination and is not intended to, and does not, confer any rights or remedies upon any other person, and is not intended to be used, and may not be used, by any other person or for any other purpose, without Duff & Phelps' express consent. Duff & Phelps has consented to the inclusion of the Opinion in its entirety and the description hereof in this proxy statement/prospectus and any other filing CLAQ is required to make with the SEC in connection with the Business Combination if such inclusion is required by the applicable law.

This Opinion (i) does not address the merits of the underlying business decision to enter into the Business Combination versus any alternative strategy or transaction; (ii) does not address or express any view on any transaction related to the Business Combination, including the PIPE Investment; (iii) is not a recommendation as to how the Board of Directors or any stockholder of CLAQ or Nauticus should vote or act with respect to any matters relating to the Business Combination, or whether to proceed with the Business Combination or any related transaction, and (iv) does not indicate that the Consideration is the best possibly attainable by CLAQ under any circumstances; instead, it merely states whether the Consideration is within a range suggested by certain financial analyses. The decision as to whether to proceed with the Business Combination or any related transaction may depend on an assessment of factors unrelated to the financial analysis on which this Opinion is based. This Opinion should not be construed as creating any fiduciary duty on the part of Duff & Phelps to any party.

Except for the Opinion expressed herein, Duff & Phelps does not express any view or opinion as to (i) any other term, aspect or implication of (a) the Business Combination (including, without limitation, the form or structure of the Business Combination) or the Merger Agreement or (b) any other agreement, transaction document or instrument contemplated by the Merger Agreement or to be entered into or amended in connection with the Business Combination, including the PIPE Investment, or (ii) the fairness, financial or otherwise, of the Business Combination to, or of any consideration to be paid to or received by, the holders of any class of securities of CLAQ or Nauticus (including, without limitation, the fairness or the potential dilutive or other effects of the Business Combination or the PIPE Investment).

This Opinion does not in any way address proportionate allocation or relative fairness (including, without limitation, the allocation of any consideration among or within any classes or groups of security holders or other constituents of CLAQ or any other party). Duff & Phelps also does not address, or express a view with respect to, any acquisition of control or effective control of the Combined Company by any stockholder or group of stockholders of Nauticus (including, without limitation, any voting, control, consent rights or similar rights, preferences or privileges as among or in comparison to any classes or groups of security holders or other constituents of CLAQ, Nauticus, the Combined Company or any other party).

This Opinion does not in any way address the appropriate capital structure of the Combined Company, whether the Combined Company should be issuing debt or equity securities or a combination of both in the Business Combination, or the form, structure or any aspect or terms of any debt or equity financing for the Business Combination (including, without limitation, the PIPE Investment) or the likelihood of obtaining such financing, or whether or not Nauticus, CLAQ, their respective security holders or any other party is receiving or paying reasonably equivalent value in the Business Combination.

This Opinion is solely that of Duff & Phelps, and Duff & Phelps' liability in connection with this Opinion shall be limited in accordance with the terms set forth in the engagement letter between Duff & Phelps and CLAQ, dated January 28, 2022 (the "[Engagement Letter](#)"). The use and disclosure of this Opinion is strictly limited in accordance with the terms set forth in the Engagement Letter.

Disclosure of Prior Relationships

Duff & Phelps has acted as financial advisor to the Board of Directors and will receive a fee for its services. No portion of Duff & Phelps' fee is refundable or contingent upon the conclusion expressed in this Opinion. Pursuant to the terms of the Engagement Letter, a portion of such fee is payable upon delivery of the Opinion and a portion is payable upon and subject to the closing of the Business Combination. Other than this engagement, during the two years preceding the date of this Opinion, Duff & Phelps has not had any material relationship with any party to the Business Combination for which compensation has been received or is intended to be received, nor is any such material relationship or related compensation mutually understood to be contemplated.

Duff & Phelps may seek to provide CLAQ, Nauticus, the Combined Company and their respective affiliates and equity holders with financial advisory and other services unrelated to the Business Combination in the future, for which services Duff & Phelps would expect to receive compensation.

Conclusion

Based upon and subject to the foregoing, Duff & Phelps is of the opinion that, as of the date hereof, the Consideration to be paid by CLAQ to the Nauticus securityholders pursuant to the Merger Agreement is fair to CLAQ, from a financial point of view.

This Opinion has been approved by the Opinion Review Committee of Duff & Phelps.

Respectfully submitted,



Duff & Phelps Opinions Practice
Kroll, LLC

PART II
INFORMATION NOT REQUIRED IN THE PROSPECTUS

Item 20. Indemnification of Directors and Officers.

Subsection (a) of Section 145 of the General Corporation Law of the State of Delaware (referred to as the “DGCL”) empowers a corporation to indemnify any person who was or is a party or who is threatened to be made a party to any threatened, pending or completed action, suit or proceeding, whether civil, criminal, administrative or investigative (other than an action by or in the right of the corporation) by reason of the fact that the person is or was a director, officer, employee or agent of the corporation, or is or was serving at the request of the corporation as a director, officer, employee or agent of another corporation, partnership, joint venture, trust or other enterprise, against expenses (including attorneys’ fees), judgments, fines and amounts paid in settlement actually and reasonably incurred by the person in connection with such action, suit or proceeding if the person acted in good faith and in a manner the person reasonably believed to be in or not opposed to the best interests of the corporation, and, with respect to any criminal action or proceeding, had no reasonable cause to believe the person’s conduct was unlawful.

Subsection (b) of Section 145 empowers a corporation to indemnify any person who was or is a party or is threatened to be made a party to any threatened, pending or completed action or suit by or in the right of the corporation to procure a judgment in its favor by reason of the fact that the person acted in any of the capacities set forth above, against expenses (including attorneys’ fees) actually and reasonably incurred by the person in connection with the defense or settlement of such action or suit if the person acted in good faith and in a manner the person reasonably believed to be in or not opposed to the best interests of the corporation, except that no indemnification shall be made in respect of any claim, issue or matter as to which such person shall have been adjudged to be liable to the corporation unless and only to the extent that the Court of Chancery or the court in which such action or suit was brought shall determine upon application that, despite the adjudication of liability but in view of all the circumstances of the case, such person is fairly and reasonably entitled to indemnity for such expenses which the Court of Chancery or such other court shall deem proper.

Section 145 further provides that to the extent a director or officer of a corporation has been successful on the merits or otherwise in the defense of any action, suit or proceeding referred to in subsections (a) and (b) of Section 145, or in defense of any claim, issue or matter therein, such person shall be indemnified against expenses (including attorneys’ fees) actually and reasonably incurred by such person in connection therewith; that indemnification provided for by Section 145 shall not be deemed exclusive of any other rights to which the indemnified party may be entitled; and the indemnification provided for by Section 145 shall, unless otherwise provided when authorized or ratified, continue as to a person who has ceased to be a director, officer, employee or agent and shall inure to the benefit of such person’s heirs, executors and administrators. Section 145 also empowers the corporation to purchase and maintain insurance on behalf of any person who is or was a director, officer, employee or agent of the corporation, or is or was serving at the request of the corporation as a director, officer, employee or agent of another corporation, partnership, joint venture, trust or other enterprise against any liability asserted against such person and incurred by such person in any such capacity, or arising out of his status as such, whether or not the corporation would have the power to indemnify such person against such liabilities under Section 145.

Section 102(b)(7) of the DGCL provides that a corporation’s certificate of incorporation may contain a provision eliminating or limiting the personal liability of a director to the corporation or its stockholders for monetary damages for breach of fiduciary duty as a director, provided that such provision shall not eliminate or limit the liability of a director (i) for any breach of the director’s duty of loyalty to the corporation or its stockholders, (ii) for acts or omissions not in good faith or which involve intentional misconduct or a knowing violation of law, (iii) under Section 174 of the DGCL or (iv) for any transaction from which the director derived an improper personal benefit.

CLAQ’s Certificate of Incorporation provides for indemnification of its directors, officers, employees and other agents to the maximum extent permitted by the DGCL, and CLAQ’s bylaws provide for indemnification of its directors, officers, employees and other agents to the maximum extent permitted by the DGCL.

In addition, effective upon the consummation of the business combination, CLAQ will enter into indemnification agreements with each of our directors and officers. These agreements will require CLAQ to indemnify these individuals to the fullest extent permitted under Delaware law against liabilities that may arise by reason of their service to CLAQ, and to advance expenses incurred as a result of any proceeding against them as to which they could be indemnified. CLAQ also intends to enter into indemnification agreements with its future directors.

Item 21. Exhibits and Financial Statements Schedules

Exhibit	Description	Incorporated by Reference			
		Schedule/ Form	File Number	Exhibits	Filing Date
2.1#	Merger Agreement dated as of December 16, 2021, by and among CleanTech Acquisition Corp., CleanTech Merger Sub, Inc., Nauticus Robotics, Inc., and Nicolaus Radford, as amended on January 30, 2021 (included as Annex A to this proxy statement/prospectus).	Form 8-K	001-40611	2.1	December 17, 2021
2.1.1	Amendment No. 2 to Merger Agreement dated June 6, 2022	Form 8-K	001-40611	2.1	June 6, 2022
3.1	Amended and Restated Certificate of Incorporation of CleanTech Acquisition Corp.	Form 8-K	001-40611	3.1	July 21, 2021
3.2	Form of Second Amended and Restated Certificate of Incorporation of CLAQ (included as Annex B to this proxy statement/prospectus).				
3.3	Bylaws of CleanTech Acquisition Corp.	Form S-1/A	333-256578	3.3	July 6, 2021
3.4	Form of Amended and Restated Bylaws of CleanTech Acquisition Corp. (included as Annex C to this proxy statement/prospectus).				
4.1	Specimen Unit Certificate of CleanTech Acquisition Corp.	Form S-1/A	333-256578	4.1	July 6, 2021
4.2	Specimen Common Stock Certificate of CleanTech Acquisition Corp.	Form S-1/A	333-256578	4.2	July 6, 2021
4.3	Specimen Warrant Certificate of CleanTech Acquisition Corp.	Form S-1/A	333-256578	4.3	July 6, 2021
4.4	Warrant Agreement, dated March 10, 2021, by and between Continental Stock Transfer & Trust Company and CleanTech Acquisition Corp.	Form 8-K	001-40611	4.1	July 21, 2021
4.5	Rights Agreement, dated July 14, 2021, by and between Continental Stock Transfer & Trust Company and CleanTech Acquisition Corp.	Form 8-K	001-40611	4.2	July 21, 2021
4.6	Form of 5% Original Issue Discount Senior Secured Debenture to be issued pursuant to the Securities Purchase Agreement dated December 16, 2021				
4.7	Form of Warrants to be issued pursuant to the Securities Purchase Agreement dated December 16, 2021				
5.1+	Opinion of Loeb & Loeb LLP regarding the validity of the securities.				
8.1	Tax Opinion of Winston & Strawn LLP				
10.1	Letter Agreement, dated July 14, 2021, by CleanTech Acquisition Corp.'s officers and directors.	Form 8-K	001-40611	10.1	July 21, 2021
10.2	Letter Agreement, dated July 14, 2021, by CleanTech Sponsor, LLC and CleanTech Investments, LLC.	Form 8-K	001-40611	10.2	July 21, 2021
10.3	Investment Management Trust Agreement, dated July 14, 2021, by and between Continental Stock Transfer & Trust Company and CleanTech Acquisition Corp.	Form 8-K	001-40611	10.3	July 21, 2021
10.4	Escrow Agreement, dated July 14, 2021, by and among CleanTech Acquisition Corp., Continental Stock Transfer & Trust Company and each of the initial stockholders.	Form 8-K	001-40611	10.4	July 21, 2021
10.5	Registration Rights Agreement, dated July 14, 2021, by and among CleanTech Acquisition Corp., and the initial stockholders.	Form 8-K	001-40611	10.5	July 21, 2021
10.6	Indemnity Agreements dated July 14, 2021 by and between CleanTech Acquisition Corp. and its directors and officers.	Form 8-K	001-40611	10.6	July 21, 2021
10.7	Subscription Agreement, dated July 14, 2021, by and between CleanTech Acquisition Corp., CleanTech Sponsor, LLC and CleanTech Investments, LLC.	Form 8-K	001-40611	10.7	July 21, 2021
10.8	Business Combination Marketing Agreement, dated July 14, 2021, by and between CleanTech Acquisition Corp. and Chardan Capital Markets, LLC.	Form 8-K	001-40611	10.8	July 21, 2021

[Table of Contents](#)

Exhibit	Description	Incorporated by Reference			
		Schedule/ Form	File Number	Exhibits	Filing Date
10.9	Administrative Services Agreement, dated July 14, 2021, by and between CleanTech Acquisition Corp. and Chardan Capital Markets, LLC.	Form 8-K	001-40611	10.9	July 21, 2021
10.9*	Form of 2022 Nauticus Robotics, Inc. Incentive Award Plan (included as Annex D to this proxy statement/prospectus).				
10.10	Financial Advisory Agreement by and between CleanTech Acquisition Corp. and Chardan Capital Markets, LLC dated December 14, 2021.	Form S-4 Am. No. 1	333-262431	10.10	March 31, 2022
10.11	Support Agreement by and among CleanTech Acquisition Corp., CleanTech Sponsor I LLC, CleanTech Investments, LLC and Nauticus Robotics, Inc.	Form 8-K	001-40611	10.1	December 17, 2021
10.12	Support Agreement by and among CleanTech Acquisition Corp., Nauticus Robotics, Inc. and certain shareholders of Nauticus Robotics, Inc.	Form 8-K	001-40611	10.2	December 17, 2021
10.13	Form of Subscription Agreement for certain investors	Form 8-K	001-40611	10.3	December 17, 2021
10.14	Securities Purchase Agreement by and among CleanTech Acquisition Corp., Nauticus Robotics, Inc. and certain investors named therein.	Form 8-K	001-40611	10.4	December 17, 2021
10.14.1	Agreement among CleanTech Acquisition Corp., Nauticus Robotics, Inc. and ATW Partners Opportunities Management, LLC dated January 31, 2022	Form S-4 Am. No. 1	333-262431	10.14.1	March 31, 2022
10.14.2	Letter Agreement between ATW Special Situations I LLC and Material Impact Fund II, L.P. dated December 15, 2021	Form S-4 Am. No. 3	333-262431	10.14.2	May 23, 2022
10.15	Form of Nauticus Robotics, Inc. Stockholder Lock-up Agreement (included as Exhibit H-1 to Exhibit 2.1 hereto)	Form 8-K	001-40611	10.5	December 17, 2021
10.16	Form of Lock-up Agreement for certain holders of Nauticus Robotics, Inc. (f/k/a CleanTech Acquisition Corp.) (included as Exhibit H-2 to the Exhibit 2.1 hereto)	Form 8-K	001-40611	10.6	December 17, 2021
10.17	Form of Amended and Restated Registration Rights Agreement by and among CleanTech Acquisition Corp., Nauticus and certain stockholders.	Form 8-K	001-40611	10.7	December 17, 2021
10.18	Form of Director Nomination Agreement (included as Exhibit G to Exhibit 2.1 hereto).	Form 8-K	001-40611	10.8	December 17, 2021
10.19	Director Designation Agreement	Form 8-K	001-40611	10.9	December 17, 2021
10.20†	Battery Supplier Agreement, dated as of January 18, 2021.				
10.21†	Fabrication Agreement, dated as of January 17, 2022.				
10.22†	Construction Agreement, dated as of February 14, 2022.				
10.23†	Commercial Proposal, dated as of December 6, 2021.				
10.24†	Defense Innovation Unit Agreement, dated as of August 10, 2021.				
10.25†	Subcontract Agreement, dated as of August 10, 2021.				
10.26	Financial Advisory Agreement by and between Nauticus Robotics, Inc. and Cowen and Company, LLC dated March 23, 2022.	Form S-4 Am. No. 2	333-262431	10.26	April 27, 2022
10.27	Amended and Restated Financial Advisory Agreement by and between Nauticus Robotics, Inc. and Coastal Equities, Inc. dated April 25, 2022	Form S-4 Am. No. 2	333-262431	10.27	April 27, 2022
10.28	Financial Advisory Agreement by and between CleanTech Acquisition Corp. and Roth Capital Partners, LLC dated February 11, 2022	Form S-4 Am. No. 3	333-262431	10.28	May 23, 2022
10.29	Financial Advisory Agreement by and among CleanTech Acquisition Corp., Nauticus Robotics, Inc. and Lake Street Capital Markets dated February 28, 2022	Form S-4 Am. No. 3	333-262431	10.29	May 23, 2022
10.30†	Kongsberg Maritime AS Agreement, dated March 21, 2022				
10.31†	Collaboration Agreement, dated as of December 4, 2020				

[Table of Contents](#)

Exhibit	Description	Incorporated by Reference			
		Schedule/ Form	File Number	Exhibits	Filing Date
10.32	Memorandum of Understanding, effective as of April 21, 2022	Form S-4 Am. No. 3	333-262431	10.32	May 23, 2022
21.1+	List of Subsidiaries.				
23.1	Consent of WithumSmith+Brown, P.C., independent registered public accounting firm of CLAQ.				
23.2	Consent of Whitley Penn, LLP, independent registered public accounting firm of Nauticus.				
23.3	Consent of Loeb & Loeb LLP (included in Exhibit 5.1).				
24.1	Power of Attorney.				
99.1	Consent of Nicolaus Radford				
99.2	Consent of Mark Mey				
99.3	Consent of Lisa Porter				
99.4+	Consent of Jim Bellingham				
99.5	Consent of Adam Sharkawy				
99.6	Consent of John W. Gibson, Jr.				
99.7	Consent of Eli Spiro				
99.8	Consent of and Joseph W. Dyer				
99.9	Preliminary Proxy Card.				
99.10	Section 262 of the DGCL (included as Annex E to the proxy statement/prospectus)				
101.INS	Inline XBRL Instance Document.				
101.CAL	Inline XBRL Taxonomy Extension Calculation Linkbase Document.				
101.SCH	Inline XBRL Taxonomy Extension Schema Document.				
101.DEF	Inline XBRL Taxonomy Extension Definition Linkbase Document.				
101.LAB	Inline XBRL Taxonomy Extension Labels Linkbase Document.				
101.PRE	Inline XBRL Taxonomy Extension Presentation Linkbase Document.				
104	Cover Page Interactive Data File (formatted as Inline XBRL and contained in Exhibit 101).				
107	Filing fee table	Form S-4 Am. No. 1	333-262431	107	March 31, 2022

* Indicates management contract or compensatory plan or arrangement.

+ To be filed by amendment.

Certain of the exhibits and schedules to this Exhibit have been omitted in accordance with Regulation S-K Item 601. The Registrant agrees to furnish a copy of all omitted exhibits and schedules to the SEC upon its request.

† The Registrant has redacted provisions or terms of this Exhibit pursuant to Regulation S-K Item 601(b)(10)(iv). While portions of the Exhibits have been omitted, these Exhibits include a prominent statement on the first page of each redacted Exhibit that certain identified information has been excluded from the exhibit because it is both not material and is the type that you treat as private or confidential. The Registrant agrees to furnish an unredacted copy of the Exhibit to the SEC upon its request.

Item 22. Undertakings

- a. The undersigned registrant hereby undertakes:
 - i. To file, during any period in which offers or sales are being made, a post-effective amendment to this registration statement:
 - (1) To include any prospectus required by Section 10(a)(3) of the Securities Act of 1933;
 - (2) To reflect in the prospectus any facts or events arising after the effective date of the registration statement (or the most recent post-effective amendment thereof) which, individually or in the aggregate, represent a fundamental change in the information set forth in the registration statement.

Notwithstanding the foregoing, any increase or decrease in volume of securities offered (if the total dollar value of securities offered would not exceed that which was registered) and any deviation from the low or high end of the estimated maximum offering range may be reflected in the form of prospectus filed with the Commission pursuant to Rule 424(b) if, in the aggregate, the changes in volume and price represent no more than a 20% change in the maximum aggregate offering price set forth in the “**Calculation of Registration Fee**” table in the effective registration statement; and

- (3) To include any material information with respect to the plan of distribution not previously disclosed in the registration statement or any material change to such information in the registration statement;
- ii. That, for the purpose of determining any liability under the Securities Act, each such post-effective amendment shall be deemed to be a new registration statement relating to the securities offered therein, and the offering of such securities at that time shall be deemed to be the initial bona fide offering thereof.
- iii. To remove from registration by means of a post-effective amendment any of the securities being registered which remain unsold at the termination of the offering.
- iv. That, for the purpose of determining liability under the Securities Act to any purchaser, each prospectus filed pursuant to Rule 424(b) as part of a registration statement relating to an offering other than registration statements relying on Rule 430B or other than prospectuses filed in reliance on Rule 430A, shall be deemed to be part of and included in the registration statement as of the date it is first used after effectiveness; provided, however, that no statement made in a registration statement or prospectus that is part of the registration statement or made in a document incorporated or deemed incorporated by reference into the registration statement or prospectus that is part of the registration statement will, as to a purchaser with a time of contract of sale prior to such first use, supersede or modify any statement that was made in the registration statement or prospectus that was part of the registration statement or made in any such document immediately prior to such date of first use.
- v. That, the undersigned registrant undertakes that in a primary offering of securities of the undersigned registrant pursuant to this registration statement, regardless of the underwriting method used to sell the securities to the purchaser, if the securities are offered or sold to such purchaser by means of any of the following communications, the undersigned registrant will be a seller to the purchaser and will be considered to offer or sell such securities to such purchaser:
 - (1) Any preliminary prospectus or prospectus of the undersigned registrant relating to the offering required to be filed pursuant to Rule 424;
 - (2) Any free writing prospectus relating to the offering prepared by or on behalf of the undersigned registrant or used or referred to by the undersigned registrant;
 - (3) The portion of any other free writing prospectus relating to the offering containing material information about the undersigned registrant or its securities provided by or on behalf of the undersigned registrant; and
 - (4) Any other communication that is an offer in the offering made by the undersigned registrant to the purchaser.
- vi. The undersigned registrant hereby undertakes as follows: that prior to any public reoffering of the securities registered hereunder through use of a prospectus which is a part of this registration statement, by any person or party who is deemed to be an underwriter within the meaning of Rule 145(c), the issuer undertakes that such reoffering prospectus will contain the information called for by the applicable registration form with respect to re-offerings by persons who may be deemed underwriters, in addition to the information called for by the other Items of the applicable Form.
- vii. The undersigned registrant hereby undertakes as follows: that every prospectus (i) that is filed pursuant to the paragraph immediately preceding, or (ii) that purports to meet the requirements of section 10(a)(3) of the Securities Act and is used in connection with an offering of securities subject to Rule 415, will be filed as a part of an amendment to the registration statement and will not be used until such amendment is effective, and that, for purposes of determining any liability under

[Table of Contents](#)

the Securities Act, each such post-effective amendment shall be deemed to be a new registration statement relating to the securities offered therein, and the offering of such securities at that time shall be deemed to be the initial bona fide offering thereof.

- viii. Insofar as indemnification for liabilities arising under the Securities Act may be permitted to directors, officers and controlling persons of the registrant pursuant to the foregoing provisions, or otherwise, the registrant has been advised that in the opinion of the Securities and Exchange Commission such indemnification is against public policy as expressed in the Securities Act and is, therefore, unenforceable. In the event that a claim for indemnification against such liabilities (other than the payment by the registrant of expenses incurred or paid by a director, officer or controlling person of the registrant in the successful defense of any action, suit or proceeding) is asserted by such director, officer or controlling person in connection with the securities being registered, the registrant will, unless in the opinion of its counsel the matter has been settled by controlling precedent, submit to a court of appropriate jurisdiction the question whether such indemnification by it is against public policy as expressed in the Securities Act and will be governed by the final adjudication of such issue.
- b. The undersigned registrant hereby undertakes to respond to requests for information that is incorporated by reference into the prospectus pursuant to Items 4, 10(b), 11, or 13 of this Form, within one business day of receipt of such request, and to send the incorporated documents by first class mail or other equally prompt means. This includes information contained in documents filed subsequent to the effective date of the registration statement through the date of responding to the request.
- c. The undersigned registrant hereby undertakes to supply by means of a post-effective amendment all information concerning a transaction, and the company being acquired involved therein, that was not the subject of and included in the registration statement when it became effective.

SIGNATURES

Pursuant to the requirements of the Securities Act, the registrant has duly caused this registration statement to be signed on its behalf by the undersigned, thereunto duly authorized, on the 16th day of June, 2022.

CLEANTECH ACQUISITION CORP.
By: <u>/s/ Eli Spiro</u>
Name: Eli Spiro
Title: Chief Executive Officer

Pursuant to the requirements of the Securities Act of 1933, this registration statement has been signed by the following persons in the capacities and on the dates indicated.

Signature	Title	Date
<u>/s/ Eli Spiro</u>	Chief Executive Officer	June 16, 2022
Eli Spiro	(Principal Executive Officer)	
<u>/s/ Richard Fitzgerald</u>	Chief Financial Officer	June 16, 2022
Richard Fitzgerald	(Principal Financial and Accounting Officer)	
<u>/s/ Jon Najarian</u>	Chairman of the Board	June 16, 2022
Jon Najarian		
<u>/s/ Bill Richardson</u>	Vice Chairman of the Board	June 16, 2022
Bill Richardson		
<u>/s/ Louis Buffalino</u>	Director	June 16, 2022
Louis Buffalino		
<u>/s/ Brendan Riley</u>	Director	June 16, 2022
Brendan Riley		
<u>/s/ Britt E. Ide</u>	Director	June 16, 2022
Britt E. Ide		
<u>/s/ Jonas Grossman</u>	Director	June 16, 2022
Jonas Grossman		
<u>/s/ Douglas Cole</u>	Director	June 16, 2022
Douglas Cole		

NEITHER THIS SECURITY NOR THE SECURITIES INTO WHICH THIS SECURITY IS CONVERTIBLE HAVE BEEN REGISTERED WITH THE SECURITIES AND EXCHANGE COMMISSION OR THE SECURITIES COMMISSION OF ANY STATE IN RELIANCE UPON AN EXEMPTION FROM REGISTRATION UNDER THE SECURITIES ACT OF 1933, AS AMENDED (THE "SECURITIES ACT"), AND, ACCORDINGLY, MAY NOT BE OFFERED OR SOLD EXCEPT PURSUANT TO AN EFFECTIVE REGISTRATION STATEMENT UNDER THE SECURITIES ACT OR PURSUANT TO AN AVAILABLE EXEMPTION FROM, OR IN A TRANSACTION NOT SUBJECT TO, THE REGISTRATION REQUIREMENTS OF THE SECURITIES ACT AND IN ACCORDANCE WITH APPLICABLE STATE SECURITIES LAWS. THIS SECURITY AND THE SECURITIES ISSUABLE UPON CONVERSION OF THIS SECURITY MAY BE PLEDGED IN CONNECTION WITH A BONA FIDE MARGIN ACCOUNT OR OTHER LOAN SECURED BY SUCH SECURITIES

Original Issue Date: _____ 2022

Original Conversion Price (subject to adjustment herein): \$15.00

\$ _____

5% ORIGINAL ISSUE DISCOUNT SENIOR SECURED CONVERTIBLE DEBENTURE
DUE _____ 2026¹

THIS 5% ORIGINAL ISSUE DISCOUNT SENIOR SECURED CONVERTIBLE DEBENTURE is one of a series of duly authorized and validly issued 5% Original Issue Discount Senior Secured Convertible Debentures of Nauticus Robotics, Inc. (f/k/a Cleantech Acquisition Corp.), a Delaware corporation (the "Company"), having its principal place of business at _____, designated as its 5% Original Issue Discount Senior Secured Convertible Debenture due _____ 2026 (this debenture, the "Debenture" and, collectively with the other debentures of such series, the "Debentures").

FOR VALUE RECEIVED, the Company promises to pay to _____ or its registered assigns (the "Holder"), or shall have paid pursuant to the terms hereunder, the principal sum of \$ _____ on _____ 2026 (the "Maturity Date") or such earlier date as this Debenture is required or permitted to be repaid as provided hereunder, and to pay interest to the Holder on the aggregate unconverted and then outstanding principal amount of this Debenture in accordance with the provisions hereof. Notwithstanding anything herein to the contrary, the Holder may, at its option upon written notice to the Company prior to the Maturity Date, elect to extend the Maturity Date by one year. This Debenture is subject to the following additional provisions:

¹ 4 years from the issuance date.

Section 1. Definitions. For the purposes hereof, in addition to the terms defined elsewhere in this Debenture, (a) capitalized terms not otherwise defined herein shall have the meanings set forth in the Purchase Agreement and (b) the following terms shall have the following meanings:

"Alternate Consideration" shall have the meaning set forth in Section 5(e).

"Bankruptcy Event" means any of the following events: (a) the Company or any Significant Subsidiary (as such term is defined in Rule 1-02(w) of Regulation S-X) thereof commences a case or other proceeding under any bankruptcy, reorganization, arrangement, adjustment of debt, relief of debtors, dissolution, insolvency or liquidation or similar law of any jurisdiction relating to the Company or any Significant Subsidiary thereof, (b) there is commenced against the Company or any Significant Subsidiary thereof any such case or proceeding that is not dismissed within 60 days after commencement, (c) the Company or any Significant Subsidiary thereof is adjudicated insolvent or bankrupt or any order of relief or other order approving any such case or proceeding is entered, (d) the Company or any Significant Subsidiary thereof suffers any appointment of any custodian or the like for it or any substantial part of its property that is not discharged or stayed within 60 calendar days after such appointment, (e) the Company or any Significant Subsidiary thereof makes a general assignment for the benefit of creditors, (f) the Company or any Significant Subsidiary thereof calls a meeting of its creditors with a view to arranging a composition, adjustment or restructuring of its debts, (g) the Company or any Significant Subsidiary thereof admits in writing that it is generally unable to pay its debts as they become due, (h) the Company or any Significant Subsidiary thereof, by any act or failure to act, expressly indicates its consent to, approval of or acquiescence in any of the foregoing or takes any corporate or other action for the purpose of effecting any of the foregoing.

"Base Conversion Price" shall have the meaning set forth in Section 5(b).

"Beneficial Ownership Limitation" shall have the meaning set forth in Section 4(d).

"Business Day" means any day other than Saturday, Sunday or other day on which commercial banks in The City of New York are authorized or required by law to remain closed; provided, however, for clarification, commercial banks shall not be deemed to be authorized or required by law to remain closed due to "stay at home", "shelter-in-place", "non-essential employee" or any other similar orders or restrictions or the closure of any physical branch locations at the direction of any governmental authority so long as the electronic funds transfer systems (including for wire transfers) of commercial banks in The City of New York are generally open for use by customers on such day.

"Buy-In" shall have the meaning set forth in Section 4(c)(v).

"Change of Control Transaction" means the occurrence after the date hereof of any of (a) an acquisition after the date hereof by an individual or legal entity or "group" (as described in Rule 13d-5(b)(1) promulgated under the Exchange Act) of effective control (whether through legal or beneficial ownership of capital stock of the Company, by contract or otherwise) of in excess of 33% of the voting securities of the Company (other than by means of conversion or exercise of the Debentures and the Securities issued together with the Debentures), (b) the Company merges into or consolidates with any other Person, or any Person merges into or consolidates with the Company and, after giving effect to such transaction, the stockholders of the Company immediately prior to such transaction own less than 66% of the aggregate voting power of the Company or the successor entity of such transaction, (c) the Company (and all of its Subsidiaries, taken as a whole) sells or transfers all or substantially all of its assets to another Person and the stockholders of the Company immediately prior to such transaction own less than 66% of the aggregate voting power of the acquiring entity immediately after the transaction, (d) a replacement at one time or within a three year period of more than one-half of the members of the Board of Directors which is not approved by a majority of those individuals who are members of the Board of Directors on the Original Issue Date (or by those individuals who are serving as members of the Board of Directors on any date whose nomination to the Board of Directors was approved by a majority of the members of the Board of Directors who are members on the date hereof), or (e) the execution by the Company of an agreement to which the Company is a party or by which it is bound, providing for any of the events set forth in clauses (a) through (d) above.

“Conversion” shall have the meaning ascribed to such term in Section 4.

“Conversion Date” shall have the meaning set forth in Section 4(a).

“Conversion Price” shall have the meaning set forth in Section 4(b).

“Conversion Schedule” means the Conversion Schedule in the form of Schedule 1 attached hereto.

“Conversion Shares” means, collectively, the shares of Common Stock issuable upon conversion of this Debenture in accordance with the terms hereof.

“Debenture Register” shall have the meaning set forth in Section 2(c).

“Dilutive Issuance” shall have the meaning set forth in Section 5(b).

“Dilutive Issuance Notice” shall have the meaning set forth in Section 5(b).

“Effectiveness Period” shall have the meaning set forth in the Registration Rights Agreement.

“Equity Conditions” means, during the period in question, (a) the Company shall have duly honored all conversions and redemptions scheduled to occur or occurring by virtue of one or more Notices of Conversion of the Holder, if any, (b) the Company shall have paid all liquidated damages and other amounts owing to the Holder in respect of this Debenture, (c)(i) there is an effective Registration Statement pursuant to which the Holder is permitted to utilize the prospectus thereunder to resell all of the shares of Common Stock issuable pursuant to the Transaction Documents (and the Company believes, in good faith, that such effectiveness will continue uninterrupted for the foreseeable future) or (ii) all of the Conversion Shares issuable pursuant to the Transaction Documents (and shares issuable in lieu of cash payments of interest) may be resold pursuant to Rule 144 without volume or manner-of-sale restrictions or current public information requirements as determined by the counsel to the Company as set forth in a written opinion letter to such effect, addressed and acceptable to the Transfer Agent and the Holder, (d) the Common Stock is trading on a Trading Market and all of the shares issuable pursuant to the Transaction Documents are listed or quoted for trading on such Trading Market (and the Company believes, in good faith, that trading of the Common Stock on a Trading Market will continue uninterrupted for the foreseeable future), (e) there is a sufficient number of authorized but unissued and otherwise unreserved shares of Common Stock for the issuance of all of the shares then issuable pursuant to the Transaction Documents, (f) there is no existing Event of Default and no existing event which, with the passage of time or the giving of notice, would constitute an Event of Default, (g) the issuance of the shares in question (or, in the case of an Optional Redemption, the shares issuable upon conversion in full of the Optional Redemption Amount) to the Holder would not violate the limitations set forth in Section 4(d) herein, (h) there has been no public announcement of a pending or proposed Fundamental Transaction or Change of Control Transaction that has not been consummated, (i) the applicable Holder is not in possession of any information provided by the Company, any of its Subsidiaries, or any of their officers, directors, employees, agents or Affiliates, that constitutes, or may constitute, material non-public information and (j) in the case of an Optional Redemption, the average daily trading volume for the Common Stock on the principal Trading Market exceeds 2,000,000 shares (subject to adjustment for reverse and forward stock splits, recapitalizations and similar transactions following the date of the Purchase Agreement) during the applicable Optional Redemption Period.

“Event of Default” shall have the meaning set forth in Section 8(a).

“Fundamental Transaction” shall have the meaning set forth in Section 5(e).

“Indebtedness” or “indebtedness” of any person shall mean, if and to the extent (other than with respect to clause (i)) the same would constitute indebtedness or a liability on a balance sheet prepared in accordance with GAAP, without duplication, (a) all obligations of such person for borrowed money, (b) all obligations of such person evidenced by bonds, debentures, notes or similar instruments, (c) all obligations of such person under conditional sale or other title retention agreements relating to property or assets purchased by such person, (d) all obligations of such person issued or assumed as the deferred purchase price of property or services (other than such obligations accrued in the ordinary course of business or consistent with past practice or industry norm), to the extent that the same would be required to be shown as a long term liability on a balance sheet prepared in accordance with GAAP, (e) all capitalized lease obligations of such person, (f) the principal component of all obligations, contingent or otherwise, of such person as an account party in respect of letters of credit, (g) the principal component of all obligations of such person in respect of bankers’ acceptances, and (h) all guarantees by such person of indebtedness described in clauses (a) to (g) above; provided, that Indebtedness shall not include (A) trade and other ordinary-course payables and intercompany liabilities arising in the ordinary course of business or consistent with past practice or industry norm, (B) accrued expenses, (C) prepaid or deferred revenue, (D) purchase price holdbacks arising in the ordinary course of business or consistent with past practice or industry norm in respect of a portion of the purchase prices of an asset to satisfy unperformed obligations of the seller of such asset, or (E) earn-out obligations until such obligations become a liability on the balance sheet of such person in accordance with GAAP.

“Interest Conversion Rate” means the Conversion Price, subject to adjustment hereunder.

“Interest Conversion Shares” shall have the meaning set forth in Section 2(a).

“Interest Notice Period” shall have the meaning set forth in Section 2(a).

“Interest Payment Date” shall have the meaning set forth in Section 2(a).

“Interest Share Amount” shall have the meaning set forth in Section 2(a).

“Late Fees” shall have the meaning set forth in Section 2(d).

“Mandatory Default Amount” means the sum of (a) the greater of (i) the outstanding principal amount of this Debenture, plus all accrued and unpaid interest hereon, divided by the Conversion Price on the date the Mandatory Default Amount is either (A) demanded (if demand or notice is required to create an Event of Default) or otherwise due or (B) paid in full, whichever has a lower Conversion Price, multiplied by the VWAP on the date the Mandatory Default Amount is either (x) demanded or otherwise due or (y) paid in full, whichever has a higher VWAP, or (ii) 130% of the outstanding principal amount of this Debenture, plus 100% of accrued and unpaid interest hereon, and (b) all other amounts, costs, expenses and liquidated damages due in respect of this Debenture.

“New York Courts” shall have the meaning set forth in Section 9(d).

“Notice of Conversion” shall have the meaning set forth in Section 4(a).

“Optional Redemption” shall have the meaning set forth in Section 6(a).

“Optional Redemption Amount” means the sum of (a) 120% of the then outstanding principal amount of the Debenture, (b) accrued but unpaid interest and (c)

all liquidated damages and other amounts due in respect of the Debenture.

“Optional Redemption Date” shall have the meaning set forth in Section 6(a).

4

“Optional Redemption Notice” shall have the meaning set forth in Section 6(a).

“Optional Redemption Notice Date” shall have the meaning set forth in Section 6(a).

“Optional Redemption Period” shall have the meaning set forth in Section 6(a).

“Original Issue Date” means the date of the first issuance of the Debentures, regardless of any transfers of any Debenture and regardless of the number of instruments which may be issued to evidence such Debentures.

“Permitted Indebtedness” means (a) the indebtedness evidenced by the Debentures, (b) the Indebtedness existing on the Original Issue Date and set forth on Schedule 3.1(bb) attached to the Purchase Agreement, (c) lease obligations (including capital leases) and purchase money indebtedness of up to \$500,000, in the aggregate, incurred in connection with the acquisition of capital assets and lease obligations with respect to newly acquired or leased assets, (d) indebtedness that (i) is expressly subordinate to the Debentures pursuant to a written subordination agreement with the Purchasers that is acceptable to each Purchaser in its sole and absolute discretion and (ii) matures at a date later than the 91st day following the Maturity Date, (e) up to \$75 million, in the aggregate, indebtedness that is senior, pari-passu or junior to the Debentures (including unsecured indebtedness), provided that (i) any such indebtedness does not include any equity or equity-linked component thereof and (ii) any pari-passu or junior indebtedness incurred pursuant to this clause (e) (other than unsecured indebtedness) shall be subject to a written intercreditor agreement with the Purchasers that is acceptable to each Purchaser in its sole discretion, and (f) additional unsecured indebtedness in an amount not to exceed \$1,500,000 in the aggregate.

“Permitted Lien” means the individual and collective reference to the following: (a) Liens for taxes, assessments and other governmental charges or levies not yet delinquent by more than 30 days or Liens for taxes, assessments and other governmental charges or levies being contested in good faith and by appropriate proceedings for which adequate reserves (in the good faith judgment of the management of the Company) have been established in accordance with GAAP, (b) Liens imposed by law which were incurred in the ordinary course of the Company’s business, such as carriers’, warehousemen’s and mechanics’ Liens, statutory landlords’ Liens, and other similar Liens arising in the ordinary course of the Company’s business which secure obligations which are not more than 30 days overdue, and which (x) do not individually or in the aggregate materially detract from the value of such property or assets or materially impair the use thereof in the operation of the business of the Company and its consolidated Subsidiaries or (y) are being contested in good faith by appropriate proceedings, which proceedings have the effect of preventing for the foreseeable future the forfeiture or sale of the property or asset subject to such Lien, (c) Liens incurred in connection with Permitted Indebtedness under clauses (a), (b), (d) and (e) thereunder, (d) Liens incurred in connection with Permitted Indebtedness under clause (c) thereunder, provided that such Liens are not secured by assets of the Company or its Subsidiaries other than the assets so acquired or leased and (e) other Liens incurred in the ordinary course of business securing obligations not to exceed \$500,000.00 in the aggregate.

5

“Purchase Agreement” means the Securities Purchase Agreement, dated as of December 16, 2021, by and among the Company, Nauticus Robotics, Inc., a Texas corporation, and the original Holders, as amended, modified or supplemented from time to time in accordance with its terms.

“Registration Rights Agreement” means the Registration Rights Agreement, dated as of the date of the Purchase Agreement, among the Company and the original Holders.

“Registration Statement” means a registration statement meeting the requirements set forth in the Registration Rights Agreement and covering the resale of the Underlying Shares by each Holder as provided for in the Registration Rights Agreement.

“Securities Act” means the Securities Act of 1933, as amended, and the rules and regulations promulgated thereunder.

“Share Delivery Date” shall have the meaning set forth in Section 4(c)(ii).

“Successor Entity” shall have the meaning set forth in Section 5(e).

“Trading Day” means a day on which the principal Trading Market is open for trading.

“Trading Market” means any of the following markets or exchanges on which the Common Stock is listed or quoted for trading on the date in question: the NYSE American, the Nasdaq Capital Market, the Nasdaq Global Market, the Nasdaq Global Select Market or the New York Stock Exchange (or any successors to any of the foregoing).

“VWAP” means, for any date, the price determined by the first of the following clauses that applies: (a) if the Common Stock is then listed or quoted on a Trading Market, the daily volume weighted average price of the Common Stock for such date (or the nearest preceding date) on the Trading Market on which the Common Stock is then listed or quoted as reported by Bloomberg L.P. (based on a Trading Day from 9:30 a.m. (New York City time) to 4:02 p.m. (New York City time)), (b) if OTCQB or OTCQX is not a Trading Market, the volume weighted average price of the Common Stock for such date (or the nearest preceding date) on OTCQB or OTCQX as applicable, (c) if the Common Stock is not then listed or quoted for trading on OTCQB or OTCQX and if prices for the Common Stock are then reported on The Pink Open Market (or a similar organization or agency succeeding to its functions of reporting prices), the most recent bid price per share of the Common Stock so reported, or (d) in all other cases, the fair market value of a share of Common Stock as determined by an independent appraiser selected in good faith by the Purchasers of a majority in interest of the Securities then outstanding and reasonably acceptable to the Company, the fees and expenses of which shall be paid by the Company.

6

a) Payment of Interest in Cash or Kind. The Company shall pay interest to the Holder on the aggregate unconverted and then outstanding principal amount of this Debenture at the rate of 5% per annum, payable quarterly on January 1, April 1, July 1 and October 1, beginning on the first such date after the Original Issue Date, on each Conversion Date (as to that principal amount then being converted), on each Optional Redemption Date (as to that principal amount then being redeemed) and on the Maturity Date (each such date, an “Interest Payment Date”) (if any Interest Payment Date is not a Business Day, then the applicable payment shall be due on the next succeeding Business Day), in cash or, at the Company’s option, in duly authorized, validly issued, fully paid and non-assessable shares of Common Stock at the Interest Conversion Rate (the dollar amount to be paid in shares, the “Interest Share Amount”) or a combination thereof; provided, however, that payment in shares of Common Stock may only occur if (i) all of the Equity Conditions have been met (unless waived by the Holder in writing) during the 5 Trading Days immediately prior to the applicable Interest Payment Date (the “Interest Notice Period”) and through and including the date such shares of Common Stock are actually issued to the Holder, (ii) the Company shall have given the Holder notice in accordance with the notice requirements set forth below, (iii) as to such Interest Payment Date, prior to such Interest Notice Period (but not more than five (5) Trading Days prior to the commencement of such Interest Notice Period), the Company shall have delivered to the Holder’s account with The Depository Trust Company a number of shares of Common Stock to be applied against such Interest Share Amount equal to the quotient of (x) the applicable Interest Share Amount divided by (y) the lesser of the (i) then Conversion Price and (ii) the Interest Conversion Rate assuming for such purposes that the Interest Payment Date is the Trading Day immediately prior to the commencement of the Interest Notice Period (the “Interest Conversion Shares”) and (iv) the average of the five (5) VWAPs ending on the Trading Day that is immediately prior to the applicable Interest Payment Date equals or exceeds 111% of the then Conversion Price.

b) Company’s Election to Pay Interest in Cash or Kind. Subject to the terms and conditions herein, the decision whether to pay interest hereunder in cash, shares of Common Stock or a combination thereof shall be at the sole discretion of the Company. Prior to the commencement of any Interest Notice Period, the Company shall deliver to the Holder a written notice of its election to pay interest hereunder on the applicable Interest Payment Date either in cash, shares of Common Stock or a combination thereof and the Interest Share Amount as to the applicable Interest Payment Date, provided that the Company may indicate in such notice that the election contained in such notice shall apply to future Interest Payment Dates until revised by a subsequent notice. During any Interest Notice Period, the Company’s election (whether specific to an Interest Payment Date or continuous) shall be irrevocable as to such Interest Payment Date. Subject to the aforementioned conditions, failure to timely deliver such written notice to the Holder shall be deemed an election by the Company to pay the interest on such Interest Payment Date in cash. At any time the Company delivers a notice to the Holder of its election to pay the interest in shares of Common Stock, the Company shall timely file a prospectus supplement pursuant to Rule 424 disclosing such election. The aggregate number of shares of Common Stock otherwise issuable to the Holder on an Interest Payment Date shall be reduced by the number of Interest Conversion Shares previously issued to the Holder in connection with such Interest Payment Date.

7

c) Interest Calculations. Interest shall be calculated on the basis of a 360-day year, consisting of twelve 30 calendar day periods, and shall accrue daily commencing on the Original Issue Date until payment in full of the outstanding principal, together with all accrued and unpaid interest, liquidated damages and other amounts which may become due hereunder, has been made. Payment of interest in shares of Common Stock (other than the Interest Conversion Shares issued prior to an Interest Notice Period) shall otherwise occur pursuant to Section 4(c)(ii) herein and, solely for purposes of the payment of interest in shares, the Interest Payment Date shall be deemed the Conversion Date. Interest shall cease to accrue with respect to any principal amount converted, provided that, the Company actually delivers the Conversion Shares within the time period required by Section 4(c)(ii) herein. Interest hereunder will be paid to the Person in whose name this Debenture is registered on the records of the Company regarding registration and transfers of this Debenture (the “Debenture Register”). Except as otherwise provided herein, if at any time the Company pays interest partially in cash and partially in shares of Common Stock to the holders of the Debentures, then such payment of cash shall be distributed ratably among the holders of the then-outstanding Debentures based on their (or their predecessor’s) initial purchases of Debentures pursuant to the Purchase Agreement.

d) Late Fee. All overdue accrued and unpaid interest to be paid hereunder shall entail a late fee at an interest rate equal to the lesser of 18% per annum or the maximum rate permitted by applicable law (the “Late Fees”) which shall accrue daily from the date such interest is due hereunder through and including the date of actual payment in full. Notwithstanding anything to the contrary contained herein, if, on any Interest Payment Date the Company has elected to pay accrued interest in the form of Common Stock but the Company is not permitted to pay accrued interest in Common Stock because it fails to satisfy the conditions for payment in Common Stock set forth in Section 2(a) herein, then, at the option of the Holder, the Company, in lieu of delivering either shares of Common Stock pursuant to this Section 2 or paying the regularly scheduled interest payment in cash, shall deliver, within three (3) Trading Days of each applicable Interest Payment Date, an amount in cash equal to the product of (x) the number of shares of Common Stock otherwise deliverable to the Holder in connection with the payment of interest due on such Interest Payment Date multiplied by (y) the highest VWAP during the period commencing on the Interest Payment Date and ending on the Trading Day prior to the date such payment is actually made. If any Interest Conversion Shares are issued to the Holder in connection with an Interest Payment Date and are not applied against an Interest Share Amount, then the Holder shall promptly return such excess shares to the Company.

8

e) Prepayment. Except as otherwise set forth in this Debenture, the Company may not prepay any portion of the principal amount of this Debenture without the prior written consent of the Holder.

Section 3. Registration of Transfers and Exchanges.

a) Different Denominations. This Debenture is exchangeable for an equal aggregate principal amount of Debentures of different authorized denominations, as requested by the Holder surrendering the same. No service charge will be payable for such registration of transfer or exchange.

b) Investment Representations. This Debenture has been issued subject to certain investment representations of the original Holder set forth in the Purchase Agreement and may be transferred or exchanged only in compliance with the Purchase Agreement and applicable federal and state securities laws and regulations.

c) Reliance on Debenture Register. Prior to due presentment for transfer to the Company of this Debenture, the Company and any agent of the Company may treat the Person in whose name this Debenture is duly registered on the Debenture Register as the owner hereof for the purpose of receiving payment as herein provided and for all other purposes, whether or not this Debenture is overdue, and neither the Company nor any such agent shall be affected by notice to the contrary.

Section 4. Conversion.

a) Voluntary Conversion. At any time after the Original Issue Date until this Debenture is no longer outstanding, this Debenture shall be convertible, in whole or in part, into shares of Common Stock at the option of the Holder, at any time and from time to time (subject to the conversion limitations set forth in Section 4(d) hereof). The Holder shall effect conversions by delivering to the Company a Notice of Conversion, the form of which is attached hereto as Annex A (each, a “Notice of Conversion”), specifying therein the principal amount of this Debenture to be converted and the date on which such conversion shall be effected (such date, the “Conversion Date”). If no Conversion Date is specified in a Notice of Conversion, the Conversion Date shall be the date that such Notice of Conversion is deemed delivered hereunder. No ink-original Notice of Conversion shall be required, nor shall any medallion guarantee (or other type of guarantee or notarization) of any Notice of Conversion form be required. To effect conversions hereunder, the Holder shall not be required to physically surrender this Debenture to the Company unless the

entire principal amount of this Debenture, plus all accrued and unpaid interest thereon, has been so converted in which case the Holder shall surrender this Debenture as promptly as is reasonably practicable after such conversion without delaying the Company's obligation to deliver the shares on the Share Delivery Date. Conversions hereunder shall have the effect of lowering the outstanding principal amount of this Debenture in an amount equal to the applicable conversion. The Holder and the Company shall maintain records showing the principal amount(s) converted and the date of such conversion(s). The Company may deliver an objection to any Notice of Conversion within one (1) Business Day of delivery of such Notice of Conversion. In the event of any dispute or discrepancy, the records of the Holder shall be controlling and determinative in the absence of manifest error. **The Holder, and any assignee by acceptance of this Debenture, acknowledge and agree that, by reason of the provisions of this paragraph, following conversion of a portion of this Debenture, the unpaid and unconverted principal amount of this Debenture may be less than the amount stated on the face hereof.**

9

b) Conversion Price. The conversion price in effect on any Conversion Date shall be equal to **\$15.00**, subject to adjustment herein (the "Conversion Price").

c) Mechanics of Conversion.

i. Conversion Shares Issuable Upon Conversion of Principal Amount. The number of Conversion Shares issuable upon a conversion hereunder shall be determined by the quotient obtained by dividing (x) 120% of the outstanding principal amount of this Debenture to be converted by (y) the Conversion Price.

ii. Delivery of Conversion Shares Upon Conversion. Not later than the earlier of (i) two (2) Trading Days and (ii) the number of Trading Days comprising the Standard Settlement Period (as defined below) after each Conversion Date (the "Share Delivery Date"), the Company shall deliver, or cause to be delivered, to the Holder (A) the Conversion Shares which, on or after the earlier of (i) the six month anniversary of the Original Issue Date or (ii) the Effective Date, shall be free of restrictive legends and trading restrictions (other than those which may then be required by the Purchase Agreement) representing the number of Conversion Shares being acquired upon the conversion of this Debenture (including, if the Company has given continuous notice pursuant to Section 2(b) for payment of interest in shares of Common Stock at least 20 Trading Days prior to the date on which the Notice of Conversion is delivered to the Company, shares of Common Stock representing the payment of accrued interest otherwise determined pursuant to Section 2(a) but assuming that the Interest Notice Period is the 20 Trading Days period immediately prior to the date on which the Notice of Conversion is delivered to the Company and excluding for such issuance the condition that the Company deliver Interest Conversion Shares as to such interest payment prior to the commencement of the Interest Notice Period) and (B) a bank check in the amount of accrued and unpaid interest (if the Company has elected or is required to pay accrued interest in cash). On or after the earlier of (i) the six-month anniversary of the Original Issue Date or (ii) the Effective Date, the Company shall deliver any Conversion Shares required to be delivered by the Company under this Section 4(c) electronically through the Depository Trust Company or another established clearing corporation performing similar functions. As used herein, "Standard Settlement Period" means the standard settlement period, expressed in a number of Trading Days, on the Company's primary Trading Market with respect to the Common Stock as in effect on the date of delivery of the Notice of Conversion.

10

iii. Failure to Deliver Conversion Shares. If, in the case of any Notice of Conversion, such Conversion Shares are not delivered to or as directed by the applicable Holder by the Share Delivery Date, the Holder shall be entitled to elect by written notice to the Company at any time on or before its receipt of such Conversion Shares, to rescind such Conversion, in which event the Company shall promptly return to the Holder any original Debenture delivered to the Company and the Holder shall promptly return to the Company the Conversion Shares issued to such Holder pursuant to the rescinded Conversion Notice.

iv. Obligation Absolute; Partial Liquidated Damages. The Company's obligations to issue and deliver the Conversion Shares upon conversion of this Debenture in accordance with the terms hereof are absolute and unconditional, irrespective of any action or inaction by the Holder to enforce the same, any waiver or consent with respect to any provision hereof, the recovery of any judgment against any Person or any action to enforce the same, or any setoff, counterclaim, recoupment, limitation or termination, or any breach or alleged breach by the Holder or any other Person of any obligation to the Company or any violation or alleged violation of law by the Holder or any other Person, and irrespective of any other circumstance which might otherwise limit such obligation of the Company to the Holder in connection with the issuance of such Conversion Shares; provided, however, that such delivery shall not operate as a waiver by the Company of any such action the Company may have against the Holder. In the event the Holder of this Debenture shall elect to convert any or all of the outstanding principal amount hereof, the Company may not refuse conversion based on any claim that the Holder or anyone associated or affiliated with the Holder has been engaged in any violation of law, agreement or for any other reason, unless an injunction from a court, on notice to Holder, restraining and or enjoining conversion of all or part of this Debenture shall have been sought and obtained, and the Company posts a surety bond for the benefit of the Holder in the amount of 150% of the outstanding principal amount of this Debenture, which is subject to the injunction, which bond shall remain in effect until the completion of arbitration/litigation of the underlying dispute and the proceeds of which shall be payable to the Holder to the extent it obtains judgment. In the absence of such injunction, the Company shall issue Conversion Shares or, if applicable, cash, upon a properly noticed conversion. If the Company fails for any reason to deliver to the Holder such Conversion Shares pursuant to Section 4(c)(ii) by the Share Delivery Date, the Company shall pay to the Holder, in cash, as liquidated damages and not as a penalty, for each \$1,000 of principal amount being converted, \$10 per Trading Day (increasing to \$20 per Trading Day on the fifth (5th) Trading Day after such liquidated damages begin to accrue) for each Trading Day after such Share Delivery Date until such Conversion Shares are delivered or Holder rescinds such conversion. Nothing herein shall limit a Holder's right to pursue actual damages or declare an Event of Default pursuant to Section 8 hereof for the Company's failure to deliver Conversion Shares within the period specified herein and the Holder shall have the right to pursue all remedies available to it hereunder, at law or in equity including, without limitation, a decree of specific performance and/or injunctive relief. The exercise of any such rights shall not prohibit the Holder from seeking to enforce damages pursuant to any other Section hereof or under applicable law.

11

v. Compensation for Buy-In on Failure to Timely Deliver Conversion Shares Upon Conversion. In addition to any other rights available to the Holder, if the Company fails for any reason to deliver to the Holder such Conversion Shares by the Share Delivery Date pursuant to Section 4(c)(ii), and if after such Share Delivery Date the Holder is required by its brokerage firm to purchase (in an open market transaction or otherwise), or the Holder's brokerage firm otherwise purchases, shares of Common Stock to deliver in satisfaction of a sale by the Holder of the Conversion Shares which the Holder was entitled to receive upon the conversion relating to such Share Delivery Date (a "Buy-In"), then the Company shall (A) pay in cash to the Holder (in addition to any other remedies available to or elected by the Holder) the amount, if any, by which (x) the Holder's total purchase price (including any brokerage commissions) for the Common Stock so purchased exceeds (y) the product of (1) the aggregate number of shares of Common Stock that the Holder was entitled to receive from the conversion at issue multiplied by (2) the actual sale price at which the sell order giving rise to such purchase obligation was executed (including any brokerage commissions) and (B) at the option of the Holder, either reissue (if surrendered) this Debenture in a principal amount equal to the principal amount of the attempted conversion (in which case such conversion shall be deemed rescinded) or deliver to the Holder the number of shares of Common Stock that would have been issued if the Company had timely complied with its delivery requirements under Section 4(c)(ii). For example, if the Holder purchases Common

Stock having a total purchase price of \$11,000 to cover a Buy-In with respect to an attempted conversion of this Debenture with respect to which the actual sale price of the Conversion Shares (including any brokerage commissions) giving rise to such purchase obligation was a total of \$10,000 under clause (A) of the immediately preceding sentence, the Company shall be required to pay the Holder \$1,000. The Holder shall provide the Company written notice indicating the amounts payable to the Holder in respect of the Buy-In and, upon request of the Company, evidence of the amount of such loss. Nothing herein shall limit a Holder's right to pursue any other remedies available to it hereunder, at law or in equity including, without limitation, a decree of specific performance and/or injunctive relief with respect to the Company's failure to timely deliver Conversion Shares upon conversion of this Debenture as required pursuant to the terms hereof.

12

vi. Reservation of Shares Issuable Upon Conversion. The Company covenants that it will at all times reserve and keep available out of its authorized and unissued shares of Common Stock for the sole purpose of issuance upon conversion of this Debenture and payment of interest on this Debenture, each as herein provided, free from preemptive rights or any other actual contingent purchase rights of Persons other than the Holder (and the other holders of the Debentures), not less than such aggregate number of shares of the Common Stock as shall (subject to the terms and conditions set forth in the Purchase Agreement) be issuable (taking into account the adjustments and restrictions of Section 5) upon the conversion of the then outstanding principal amount of this Debenture and payment of interest hereunder. The Company covenants that all shares of Common Stock that shall be so issuable shall, upon issue, be duly authorized, validly issued, fully paid and nonassessable and, if the Registration Statement is then effective under the Securities Act, shall be registered for public resale in accordance with such Registration Statement (subject to such Holder's compliance with its obligations under the Registration Rights Agreement).

vii. Fractional Shares. No fractional shares or scrip representing fractional shares shall be issued upon the conversion of this Debenture. As to any fraction of a share which the Holder would otherwise be entitled to purchase upon such conversion, the Company shall at its election, either pay a cash adjustment in respect of such final fraction in an amount equal to such fraction multiplied by the Conversion Price or round up to the next whole share.

viii. Transfer Taxes and Expenses. The issuance of Conversion Shares on conversion of this Debenture shall be made without charge to the Holder hereof for any documentary stamp or similar taxes that may be payable in respect of the issue or delivery of such Conversion Shares, provided that the Company shall not be required to pay any tax that may be payable in respect of any transfer involved in the issuance and delivery of any such Conversion Shares upon conversion in a name other than that of the Holder of this Debenture so converted and the Company shall not be required to issue or deliver such Conversion Shares unless or until the Person or Persons requesting the issuance thereof shall have paid to the Company the amount of such tax or shall have established to the satisfaction of the Company that such tax has been paid. The Company shall pay all Transfer Agent fees required for same-day processing of any Notice of Conversion and all fees to the Depository Trust Company (or another established clearing corporation performing similar functions) required for same-day electronic delivery of the Conversion Shares.

13

d) Holder's Conversion Limitations. The Company shall not effect any conversion of this Debenture, and a Holder shall not have the right to convert any portion of this Debenture, to the extent that after giving effect to the conversion set forth on the applicable Notice of Conversion, the Holder (together with the Holder's Affiliates, and any other Persons acting as a group together with the Holder or any of the Holder's Affiliates (such Persons, "Attribution Parties")) would beneficially own in excess of the Beneficial Ownership Limitation (as defined below). For purposes of the foregoing sentence, the number of shares of Common Stock beneficially owned by the Holder and its Affiliates and Attribution Parties shall include the number of shares of Common Stock issuable upon conversion of this Debenture with respect to which such determination is being made, but shall exclude the number of shares of Common Stock which would be issuable upon (i) conversion of the remaining, unconverted principal amount of this Debenture beneficially owned by the Holder or any of its Affiliates or Attribution Parties and (ii) exercise or conversion of the unexercised or unconverted portion of any other securities of the Company subject to a limitation on conversion or exercise analogous to the limitation contained herein (including, without limitation, any other Debentures or the Warrants) beneficially owned by the Holder or any of its Affiliates or Attribution Parties. Except as set forth in the preceding sentence, for purposes of this Section 4(d), beneficial ownership shall be calculated in accordance with Section 13(d) of the Exchange Act and the rules and regulations promulgated thereunder. To the extent that the limitation contained in this Section 4(d) applies, the determination of whether this Debenture is convertible (in relation to other securities owned by the Holder together with any Affiliates and Attribution Parties) and of which principal amount of this Debenture is convertible shall be in the sole discretion of the Holder, and the submission of a Notice of Conversion shall be deemed to be the Holder's determination of whether this Debenture may be converted (in relation to other securities owned by the Holder together with any Affiliates or Attribution Parties) and which principal amount of this Debenture is convertible, in each case subject to the Beneficial Ownership Limitation, and the Company shall have no obligation to verify or confirm the accuracy of such determination. In addition, a determination as to any group status as contemplated above shall be determined in accordance with Section 13(d) of the Exchange Act and the rules and regulations promulgated thereunder. For purposes of this Section 4(d), in determining the number of outstanding shares of Common Stock, the Holder may rely on the number of outstanding shares of Common Stock as reflected in (A) the Company's most recent periodic or annual report filed with the Commission, as the case may be, (B) a more recent public announcement by the Company, or (C) a more recent written notice by the Company or the Company's transfer agent setting forth the number of shares of Common Stock outstanding. Upon the written or oral request of a Holder, the Company shall within one Trading Day confirm orally and in writing to the Holder the number of shares of Common Stock then outstanding. In any case, the number of outstanding shares of Common Stock shall be determined after giving effect to the conversion or exercise of securities of the Company, including this Debenture, by the Holder or its Affiliates since the date as of which such number of outstanding shares of Common Stock was reported. The "Beneficial Ownership Limitation" shall be 4.99% of the number of shares of the Common Stock outstanding immediately after giving effect to the issuance of shares of Common Stock issuable upon conversion of this Debenture. The Holder, upon notice to the Company, may increase or decrease the Beneficial Ownership Limitation provisions of this Section 4(d), provided that the Beneficial Ownership Limitation in no event exceeds 9.99% of the number of shares of the Common Stock outstanding immediately after giving effect to the issuance of shares of Common Stock upon conversion of this Debenture held by the Holder and the Beneficial Ownership Limitation provisions of this Section 4(d) shall continue to apply. Any increase in the Beneficial Ownership Limitation will not be effective until the 61st day after such notice is delivered to the Company. The Beneficial Ownership Limitation provisions of this paragraph shall be construed and implemented in a manner otherwise than in strict conformity with the terms of this Section 4(d) to correct this paragraph (or any portion hereof) which may be defective or inconsistent with the intended Beneficial Ownership Limitation contained herein or to make changes or supplements necessary or desirable to properly give effect to such limitation. The limitations contained in this paragraph shall apply to a successor holder of this Debenture.

14

Section 5. Certain Adjustments.

a) Stock Dividends and Stock Splits. If the Company, at any time while this Debenture is outstanding: (i) pays a stock dividend or otherwise makes a distribution or distributions payable in shares of Common Stock on shares of Common Stock or any Common Stock Equivalents (which, for avoidance of doubt, shall

not include any shares of Common Stock issued by the Company upon conversion of, or payment of interest on, the Debentures), (ii) subdivides outstanding shares of Common Stock into a larger number of shares, (iii) combines (including by way of a reverse stock split) outstanding shares of Common Stock into a smaller number of shares or (iv) issues, in the event of a reclassification of shares of the Common Stock, any shares of capital stock of the Company, then the Conversion Price shall be multiplied by a fraction of which the numerator shall be the number of shares of Common Stock (excluding any treasury shares of the Company) outstanding immediately before such event, and of which the denominator shall be the number of shares of Common Stock outstanding immediately after such event. Any adjustment made pursuant to this Section shall become effective immediately after the record date for the determination of stockholders entitled to receive such dividend or distribution and shall become effective immediately after the effective date in the case of a subdivision, combination or re-classification.

b) Subsequent Equity Sales. If, at any time while this Debenture is outstanding, the Company or any Subsidiary, as applicable, sells or grants any option to purchase, or otherwise issues, any Common Stock or Common Stock Equivalents entitling any Person to acquire shares of Common Stock at an effective price per share that is lower than the then Conversion Price (such lower price, the “Base Conversion Price” and such issuances, collectively, a “Dilutive Issuance”), then simultaneously with the consummation of each Dilutive Issuance the Conversion Price shall be reduced to equal the Base Conversion Price, provided that the Base Conversion Price shall not be less than \$2.00 (subject to adjustment for reverse and forward stock splits, recapitalizations and similar transactions following the date of the Purchase Agreement). Notwithstanding the foregoing, no adjustment will be made under this Section 5(b) in respect of an Exempt Issuance. If the Company enters into a Variable Rate Transaction, despite the prohibition set forth in the Purchase Agreement, the Company shall be deemed to have issued Common Stock or Common Stock Equivalents at the lowest possible conversion price at which such securities may be converted or exercised. The Company shall notify the Holder in writing, no later than the Trading Day following the issuance of any Common Stock or Common Stock Equivalents subject to this Section 5(b), indicating therein the applicable issuance price, or applicable reset price, exchange price, conversion price and other pricing terms (such notice, the “Dilutive Issuance Notice”). For purposes of clarification, whether or not the Company provides a Dilutive Issuance Notice pursuant to this Section 5(b), upon the occurrence of any Dilutive Issuance, the Holder is entitled to receive a number of Conversion Shares based upon the Base Conversion Price on or after the date of such Dilutive Issuance, regardless of whether the Holder accurately refers to the Base Conversion Price in the Notice of Conversion.

15

c) Subsequent Rights Offerings. In addition to any adjustments pursuant to Section 5(a) above, if at any time the Company grants, issues or sells any Common Stock Equivalents or rights to purchase stock, warrants, securities or other property pro rata to the record holders of any class of shares of Common Stock (the “Purchase Rights”), then the Holder will be entitled to acquire, upon the terms applicable to such Purchase Rights, the aggregate Purchase Rights which the Holder could have acquired if the Holder had held the number of shares of Common Stock acquirable upon complete conversion of this Debenture (without regard to any limitations on exercise hereof, including without limitation, the Beneficial Ownership Limitation) immediately before the date on which a record is taken for the grant, issuance or sale of such Purchase Rights, or, if no such record is taken, the date as of which the record holders of shares of Common Stock are to be determined for the grant, issue or sale of such Purchase Rights (provided, however, that, to the extent that the Holder’s right to participate in any such Purchase Right would result in the Holder exceeding the Beneficial Ownership Limitation, then the Holder shall not be entitled to participate in such Purchase Right to such extent (or beneficial ownership of such shares of Common Stock as a result of such Purchase Right to such extent) and such Purchase Right to such extent shall be held in abeyance for the Holder until such time, if ever, as its right thereto would not result in the Holder exceeding the Beneficial Ownership Limitation).

d) Pro Rata Distributions. During such time as this Debenture is outstanding, if the Company shall declare or make any dividend or other distribution of its assets (or rights to acquire its assets) to holders of shares of Common Stock, by way of return of capital or otherwise (including, without limitation, any distribution of cash, stock or other securities, property or options by way of a dividend, spin off, reclassification, corporate rearrangement, scheme of arrangement or other similar transaction) (a “Distribution”), at any time after the issuance of this Debenture, then, in each such case, the Holder shall be entitled to participate in such Distribution to the same extent that the Holder would have participated therein if the Holder had held the number of shares of Common Stock acquirable upon complete conversion of this Debenture (without regard to any limitations on conversion hereof, including without limitation, the Beneficial Ownership Limitation) immediately before the date of which a record is taken for such Distribution, or, if no such record is taken, the date as of which the record holders of shares of Common Stock are to be determined for the participation in such Distribution (provided, however, that, to the extent that the Holder’s right to participate in any such Distribution would result in the Holder exceeding the Beneficial Ownership Limitation, then the Holder shall not be entitled to participate in such Distribution to such extent (or in the beneficial ownership of any shares of Common Stock as a result of such Distribution to such extent) and the portion of such Distribution shall be held in abeyance for the benefit of the Holder until such time, if ever, as its right thereto would not result in the Holder exceeding the Beneficial Ownership Limitation).

16

e) Fundamental Transaction. If, at any time while this Debenture is outstanding, (i) the Company, directly or indirectly, in one or more related transactions effects any merger or consolidation of the Company with or into another Person, (ii) the Company (and all of its Subsidiaries, taken as a whole), directly or indirectly, effects any sale, lease, license, assignment, transfer, conveyance or other disposition of all or substantially all of its assets in one or a series of related transactions, (iii) any, direct or indirect, purchase offer, tender offer or exchange offer (whether by the Company or another Person) is completed pursuant to which holders of Common Stock are permitted to sell, tender or exchange their shares for other securities, cash or property and has been accepted by the holders of 50% or more of the outstanding Common Stock, (iv) the Company, directly or indirectly, in one or more related transactions effects any reclassification, reorganization or recapitalization of the Common Stock or any compulsory share exchange pursuant to which the Common Stock is effectively converted into or exchanged for other securities, cash or property, or (v) the Company, directly or indirectly, in one or more related transactions consummates a stock or share purchase agreement or other business combination (including, without limitation, a reorganization, recapitalization, spin-off, merger or scheme of arrangement) with another Person or group of Persons whereby such other Person or group acquires more than 50% of the outstanding shares of Common Stock (not including any shares of Common Stock held by the other Person or other Persons making or party to, or associated or affiliated with the other Persons making or party to, such stock or share purchase agreement or other business combination) (each a “Fundamental Transaction”), then, upon any subsequent conversion of this Debenture, the Holder shall have the right to receive, for each Conversion Share that would have been issuable upon such conversion immediately prior to the occurrence of such Fundamental Transaction (without regard to any limitation in Section 4(d) on the conversion of this Debenture), the number of shares of Common Stock of the successor or acquiring corporation or of the Company, if it is the surviving corporation, and any additional consideration (the “Alternate Consideration”) receivable as a result of such Fundamental Transaction by a holder of the number of shares of Common Stock for which this Debenture is convertible immediately prior to such Fundamental Transaction (without regard to any limitation in Section 4(d) on the conversion of this Debenture). For purposes of any such conversion, the determination of the Conversion Price shall be appropriately adjusted to apply to such Alternate Consideration based on the amount of Alternate Consideration issuable in respect of one (1) share of Common Stock in such Fundamental Transaction, and the Company shall apportion the Conversion Price among the Alternate Consideration in a reasonable manner reflecting the relative value of any different components of the Alternate Consideration. If holders of Common Stock are given any choice as to the securities, cash or property to be received in a Fundamental Transaction, then the Holder shall be given the same choice as to the Alternate Consideration it receives upon any conversion of this Debenture following such Fundamental Transaction. The Company shall cause any successor entity in a Fundamental Transaction in which the Company is not the survivor (the “Successor Entity”) to assume in writing all of the obligations of the Company under this Debenture and the other Transaction Documents (as defined in the Purchase Agreement) in accordance with the provisions of this Section 5(e) pursuant to written agreements in form and substance reasonably satisfactory to the Holder and approved by the Holder (without unreasonable delay) prior to such Fundamental Transaction and shall, at the option of the holder of this Debenture, deliver to the Holder in exchange for this Debenture a security of the Successor Entity evidenced by a written instrument substantially similar in form and substance to this Debenture which is convertible for a corresponding number of shares of capital stock of such Successor Entity (or its parent entity) equivalent to the shares of Common Stock acquirable and receivable upon conversion of this Debenture (without regard to any limitations on the conversion of this Debenture) prior to such Fundamental Transaction, and with a conversion

price which applies the conversion price hereunder to such shares of capital stock (but taking into account the relative value of the shares of Common Stock pursuant to such Fundamental Transaction and the value of such shares of capital stock, such number of shares of capital stock and such conversion price being for the purpose of protecting the economic value of this Debenture immediately prior to the consummation of such Fundamental Transaction), and which is reasonably satisfactory in form and substance to the Holder. Upon the occurrence of any such Fundamental Transaction, the Successor Entity shall succeed to, and be substituted for (so that from and after the date of such Fundamental Transaction, the provisions of this Debenture and the other Transaction Documents referring to the “Company” shall refer instead to the Successor Entity), and may exercise every right and power of the Company and shall assume all of the obligations of the Company under this Debenture and the other Transaction Documents with the same effect as if such Successor Entity had been named as the Company herein.

f) Calculations. All calculations under this Section 5 shall be made to the nearest cent or the nearest 1/100th of a share, as the case may be. For purposes of this Section 5, the number of shares of Common Stock deemed to be issued and outstanding as of a given date shall be the sum of the number of shares of Common Stock (excluding any treasury shares of the Company) issued and outstanding.

g) Notice to the Holder.

i. Adjustment to Conversion Price. Whenever the Conversion Price is adjusted pursuant to any provision of this Section 5, the Company shall promptly deliver to each Holder a notice setting forth the Conversion Price after such adjustment and setting forth a brief statement of the facts requiring such adjustment.

ii. Notice to Allow Conversion by Holder. If (A) the Company shall declare a dividend (or any other distribution in whatever form) on the Common Stock, (B) the Company shall declare a special nonrecurring cash dividend on or a redemption of the Common Stock, (C) the Company shall authorize the granting to all holders of the Common Stock of rights or warrants to subscribe for or purchase any shares of capital stock of any class or of any rights, (D) the approval of any stockholders of the Company shall be required in connection with any reclassification of the Common Stock, any consolidation or merger to which the Company (and all of its Subsidiaries, taken as a whole) is a party, any sale or transfer of all or substantially all of the assets of the Company, or any compulsory share exchange whereby the Common Stock is converted into other securities, cash or property or (E) the Company shall authorize the voluntary or involuntary dissolution, liquidation or winding up of the affairs of the Company, then, in each case, the Company shall cause to be filed at each office or agency maintained for the purpose of conversion of this Debenture, and shall cause to be delivered to the Holder at its last address as it shall appear upon the Debenture Register, at least twenty (20) calendar days prior to the applicable record or effective date hereinafter specified, a notice stating (x) the date on which a record is to be taken for the purpose of such dividend, distribution, redemption, rights or warrants, or if a record is not to be taken, the date as of which the holders of the Common Stock of record to be entitled to such dividend, distributions, redemption, rights or warrants are to be determined or (y) the date on which such reclassification, consolidation, merger, sale, transfer or share exchange is expected to become effective or close, and the date as of which it is expected that holders of the Common Stock of record shall be entitled to exchange their shares of the Common Stock for securities, cash or other property deliverable upon such reclassification, consolidation, merger, sale, transfer or share exchange, provided that the failure to deliver such notice or any defect therein or in the delivery thereof shall not affect the validity of the corporate action required to be specified in such notice. To the extent that any notice provided hereunder constitutes, or contains, material, non-public information regarding the Company or any of the Subsidiaries, the Company shall simultaneously file such notice with the Commission pursuant to a Current Report on Form 8-K. The Holder shall remain entitled to convert this Debenture during the 20-day period commencing on the date of such notice through the effective date of the event triggering such notice except as may otherwise be expressly set forth herein.

Section 6. Redemption.

a) Optional Redemption at Election of Company. Subject to the provisions of this Section 6(a), at any time after the Effective Date, the Company may deliver a notice to the Holder (an “Optional Redemption Notice” and the date such notice is deemed delivered hereunder, the “Optional Redemption Notice Date”) of its irrevocable election to redeem some or all of the then outstanding principal amount of this Debenture for cash in an amount equal to the Optional Redemption Amount on the 60th Trading Day following the Optional Redemption Notice Date (such date, the “Optional Redemption Date”, such 60 Trading Day period, the “Optional Redemption Period” and such redemption, the “Optional Redemption”). The Optional Redemption Amount is payable in full on the Optional Redemption Date. Additionally, upon any Optional Redemption the Company shall also issue to the Holder a Common Stock purchase warrant to purchase up to a number of shares of Common Stock equal to 60% of the principal amount of this Debenture being redeemed divided by the then Conversion Price, with an exercise price equal to the then Conversion Price and a term of exercise equal to 10 years from the date of issuance thereof, otherwise in the form of the Warrant. Such warrant certificate shall be issued within 3 Trading Days of the Redemption and shall have customary piggyback registration rights reasonably acceptable to the Holder. The Company may only effect an Optional Redemption if each of the Equity Conditions shall have been met (unless waived in writing by the Holder) on each Trading Day during the period commencing on the Optional Redemption Notice Date through to the Optional Redemption Date and through and including the date payment of the Optional Redemption Amount is actually made in full. If any of the Equity Conditions shall cease to be satisfied at any time during the Optional Redemption Period, then the Holder may elect to nullify the Optional Redemption Notice by notice to the Company within 3 Trading Days after the first day on which any such Equity Condition has not been met (provided that if, by a provision of the Transaction Documents, the Company is obligated to notify the Holder of the non-existence of an Equity Condition, such notice period shall be extended to the third Trading Day after proper notice from the Company) in which case the Optional Redemption Notice shall be null and void, ab initio. The Company covenants and agrees that it will honor all Notices of Conversion tendered from the time of delivery of the Optional Redemption Notice through the date all amounts owing thereon are due and paid in full. The Company’s determination to pay an Optional Redemption in cash shall be applied ratably to all of the holders of the then outstanding Debentures based on their (or their predecessor’s) initial purchases of Debentures pursuant to the Purchase Agreement.

b) Redemption Procedure. The payment of cash or issuance of Common Stock, as applicable, pursuant to an Optional Redemption or shall be payable on the Optional Redemption Date. If any portion of the payment pursuant to an Optional Redemption shall not be paid by the Company by the applicable due date, interest shall accrue thereon at an interest rate equal to the lesser of 18% per annum or the maximum rate permitted by applicable law until such amount is paid in full. Notwithstanding anything herein contained to the contrary, if any portion of the Optional Redemption Amount remains unpaid after such date, the Holder may elect, by written notice to the Company given at any time thereafter, to invalidate such Optional Redemption, ab initio, and, with respect to the Company’s failure to honor the Optional Redemption, the Company shall have no further right to exercise such Optional Redemption. Notwithstanding anything to the contrary in this Section 6, the Company’s determination to redeem in cash or its elections under Section 6(b) shall be applied ratably among the Holders of Debentures. The Holder may elect to convert the outstanding principal amount of the Debenture pursuant to Section 4 prior to actual payment in cash for any redemption under this Section 6 by the delivery of a Notice of Conversion to the Company.

Section 7. Negative Covenants. As long as any portion of this Debenture remains outstanding, unless the holders of at least 51% in principal amount of the then outstanding Debentures shall have otherwise given prior written consent, the Company shall not, and shall not permit any of the Subsidiaries to, directly or indirectly:

- a) other than Permitted Indebtedness, enter into, create, incur, assume, guarantee or suffer to exist any indebtedness for borrowed money of any kind, including, but not limited to, a guarantee, on or with respect to any of its property or assets now owned or hereafter acquired or any interest therein or any income or profits therefrom;
- b) other than Permitted Liens, enter into, create, incur, assume or suffer to exist any Liens of any kind, on or with respect to any of its property or assets now owned or hereafter acquired or any interest therein or any income or profits therefrom;
- c) amend its charter documents, including, without limitation, its certificate of incorporation and bylaws, in any manner that materially and adversely affects any rights of the Holder;
- d) repay, repurchase or offer to repay, repurchase or otherwise acquire more than a de minimis number of shares of its Common Stock or Common Stock Equivalents other than as to (i) the Conversion Shares or Warrant Shares as permitted or required under the Transaction Documents and (ii) repurchases of Common Stock or Common Stock Equivalents of departing officers and directors of the Company, provided that such repurchases shall not exceed an aggregate of \$100,000 for all officers and directors during the term of this Debenture;
- e) repay, repurchase or offer to repay, repurchase or otherwise acquire any Indebtedness, other than (i) the Debentures if on a pro-rata basis, (ii) regularly scheduled principal and interest payments as such terms are in effect as of the Original Issue Date and (iii) regularly scheduled principal and interest payments of Permitted Indebtedness (other than unsecured Permitted Indebtedness incurred pursuant to clause (e) of the definition of “Permitted Indebtedness”) pursuant to the terms thereof; provided that payments pursuant to the foregoing clauses (ii) and (iii) shall not be permitted if, at such time, or after giving effect to such payment, any Event of Default exist or occur;
- f) pay cash dividends or distributions on any equity securities of the Company;
- g) enter into any transaction with any Affiliate of the Company which would be required to be disclosed in any public filing with the Commission, unless such transaction is made on an arm’s-length basis and expressly approved by a majority of the disinterested directors of the Company (even if less than a quorum otherwise required for board approval);

20

h) permit Nauticus Robotics, Inc., a Texas corporation and Subsidiary of the Company (together with any of its successors and assigns, “Nauticus Sub”), to merge or become a party to any merger, amalgamation, or consolidation with any Person where Nauticus Sub is not the surviving Person or whereby Nauticus Sub would cease to be a wholly owned subsidiary of the Company as a result of such merger, amalgamation, or consolidation (any such merger, amalgamation, or consolidation, a “Nauticus Sub Merger”), unless the surviving Person into which Nauticus Sub is merged as a result of such Nauticus Sub Merger (such surviving Person, the “Nauticus Sub Surviving Entity”) (i) becomes a wholly owned subsidiary of the Company concurrently with and as an immediate result of such Nauticus Sub Merger, and (ii) concurrently with the consummation of such Nauticus Sub Merger, the Company pledges all of the outstanding capital stock of the Nauticus Sub Surviving Entity to the Agent (as defined in the Pledge and Security Agreement) as additional collateral for the obligations of the Company under this Debenture and complies with all of the requirements of Section 10 hereof;

i) sell or grant any right to reprice any Common Stock or Common Stock Equivalents entitling any Person to acquire shares of Common Stock at an effective price per share that is lower than the then Conversion Price, whether by operation of purchase price adjustments, reset provisions, floating conversion, exercise or exchange prices or otherwise, or due to warrants, options or rights which entitles such Person to receive shares of Common Stock at an effective price per share that is lower than the Conversion Price; or

j) enter into any agreement with respect to any of the foregoing.

Section 8. Events of Default.

a) “Event of Default” means, wherever used herein, any of the following events (whatever the reason for such event and whether such event shall be voluntary or involuntary or effected by operation of law or pursuant to any judgment, decree or order of any court, or any order, rule or regulation of any administrative or governmental body):

i. any default in the payment of (A) the principal amount of any Debenture or (B) interest, liquidated damages and other amounts owing to a Holder on any Debenture, as and when the same shall become due and payable (whether on a Conversion Date or the Maturity Date or by acceleration or otherwise) which default, solely in the case of an interest payment or other default under clause (B) above, is not cured within 3 Trading Days;

ii. the Company shall fail to observe or perform any other covenant or agreement contained in the Debentures (other than a breach by the Company of its obligations to deliver shares of Common Stock to the Holder upon conversion, which breach is addressed in clause (xi) below) or in any Transaction Document, which failure is not cured, if possible to cure, within the earlier to occur of (A) 5 Trading Days after notice of such failure sent by the Holder or by any other Holder to the Company and (B) 10 Trading Days after the Company has become or should have become aware of such failure;

21

iii. a default or event of default, which such default is not cured, if possible to cure, within the earlier of (A) 5 Trading Days after notice of such default or event of default sent by the Holder or by any other Holder to the Company and (B) 10 Trading Days after the Company has become or should have become aware of such default or event of default, shall occur under (A) any of the Transaction Documents or (B) any other material agreement, lease, document or instrument to which the Company or any Subsidiary is obligated (and not covered by clause (vi) below);

iv. any representation or warranty made in this Debenture, any other Transaction Documents, any written statement pursuant hereto or thereto or any other report, financial statement or certificate made or delivered to the Holder or any other Holder shall be untrue or incorrect in any material respect as of the date when made or deemed made, which failure is not cured, if possible to cure, within the earlier to occur of (A) 5 Trading Days after notice of such failure sent by the Holder or by any other Holder to the Company and (B) 10 Trading Days after the Company has become or should have become aware of such failure;

v. the Company or any Significant Subsidiary (as such term is defined in Rule 1-02(w) of Regulation S-X) shall be subject to a Bankruptcy Event;

vi. the Company or any Subsidiary shall default on any of its obligations under any mortgage, credit agreement or other facility, indenture agreement, factoring agreement or other instrument under which there may be issued, or by which there may be secured or evidenced, any indebtedness for borrowed money or money due under any long term leasing or factoring arrangement that (a) involves an obligation greater than \$500,000 whether such indebtedness now exists or shall hereafter be created, and (b) results in such indebtedness becoming or being declared due and payable prior to the date on which it would otherwise become due and payable;

vii. the Common Stock shall not be eligible for listing or quotation for trading on a Trading Market and shall not be eligible to resume listing or quotation for trading thereon within five Trading Days;

viii. the Company (and all of its Subsidiaries, taken as a whole) shall be a party to any Change of Control Transaction or Fundamental Transaction or shall agree to sell or dispose of all or in excess of 33% of its assets in one transaction or a series of related transactions (whether or not such sale would constitute a Change of Control Transaction);

ix. the Initial Registration Statement (as defined in the Registration Rights Agreement) shall not have been declared effective by the Commission on or prior to the 120th calendar day after the Closing Date or the Company does not meet the current public information requirements under Rule 144 in respect of the Registrable Securities (as defined in the Registration Rights Agreement);

x. if, during the Effectiveness Period (as defined in the Registration Rights Agreement), either (a) the effectiveness of the Registration Statement lapses for any reason or (b) the Holder shall not be permitted to resell Registrable Securities (as defined in the Registration Rights Agreement) under the Registration Statement for a period of more than 20 consecutive Trading Days or 30 non-consecutive Trading Days during any 12 month period; provided, however, that if the Company is negotiating a merger, consolidation, acquisition or sale of all or substantially all of its assets or a similar transaction and, in the written opinion of counsel to the Company, the Registration Statement would be required to be amended to include information concerning such pending transaction(s) or the parties thereto which information is not available or may not be publicly disclosed at the time, the Company shall be permitted an additional 10 consecutive Trading Days during any 12 month period pursuant to this Section 8(a)(x);

22

xi. the Company shall fail for any reason to deliver Conversion Shares to a Holder prior to the fifth Trading Day after a Conversion Date pursuant to Section 4(c) or the Company shall provide at any time notice to the Holder, including by way of public announcement, of the Company's intention to not honor requests for conversions of any Debentures in accordance with the terms hereof;

xii. the electronic transfer by the Company of shares of Common Stock through the Depository Trust Company or another established clearing corporation is no longer available or is subject to a "chill";

xiii. any monetary judgment, writ or similar final process shall be entered or filed against the Company, any subsidiary or any of their respective property or other assets for more than \$500,000, and such judgment, writ or similar final process shall remain unvacated, unbonded or unstayed for a period of 45 calendar days; or

xiv. a false or inaccurate certification (including a false or inaccurate deemed certification) by the Company that the Equity Conditions are satisfied or that there has been no Equity Conditions Failure or as to whether any Event of Default has occurred.

b) Remedies Upon Event of Default. If any Event of Default occurs, the outstanding principal amount of this Debenture, plus accrued but unpaid interest, liquidated damages and other amounts owing in respect thereof through the date of acceleration, shall become, at the Holder's election, immediately due and payable in cash at the Mandatory Default Amount. Commencing 5 days after the occurrence of any Event of Default that results in the eventual acceleration of this Debenture, the interest rate on this Debenture shall accrue at an interest rate equal to the lesser of 18% per annum or the maximum rate permitted under applicable law. Upon the payment in full of the Mandatory Default Amount, the Holder shall promptly surrender this Debenture to or as directed by the Company. In connection with such acceleration described herein, the Holder need not provide, and the Company hereby waives, any presentment, demand, protest or other notice of any kind, and the Holder may immediately and without expiration of any grace period enforce any and all of its rights and remedies hereunder and all other remedies available to it under applicable law. Such acceleration may be rescinded and annulled by Holder at any time prior to payment hereunder and the Holder shall have all rights as a holder of the Debenture until such time, if any, as the Holder receives full payment pursuant to this Section 8(b). No such rescission or annulment shall affect any subsequent Event of Default or impair any right consequent thereon.

Section 9. Miscellaneous.

a) Notices. Any and all notices or other communications or deliveries to be provided by the Holder hereunder, including, without limitation, any Notice of Conversion, shall be in writing and delivered personally, by facsimile, by email attachment, or sent by a nationally recognized overnight courier service, addressed to the Company, at the address set forth above, or such other facsimile number, email address, or address as the Company may specify for such purposes by notice to the Holder delivered in accordance with this Section 9(a). Any and all notices or other communications or deliveries to be provided by the Company hereunder shall be in writing and delivered personally, by facsimile, by email attachment, or sent by a nationally recognized overnight courier service addressed to each Holder at the facsimile number, email address or address of the Holder appearing on the books of the Company, or if no such facsimile number or email attachment or address appears on the books of the Company, at the principal place of business of such Holder, as set forth in the Purchase Agreement. Any notice or other communication or deliveries hereunder shall be deemed given and effective on the earliest of (i) the date of transmission, if such notice or communication is delivered via facsimile at the facsimile number or email attachment to the email address set forth on the signature pages attached hereto prior to 5:30 p.m. (New York City time) on any date, (ii) the next Trading Day after the date of transmission, if such notice or communication is delivered via facsimile at the facsimile number or email attachment to the email address set forth on the signature pages attached hereto on a day that is not a Trading Day or later than 5:30 p.m. (New York City time) on any Trading Day, (iii) the second Trading Day following the date of mailing, if sent by U.S. nationally recognized overnight courier service or (iv) upon actual receipt by the party to whom such notice is required to be given.

23

b) Absolute Obligation. Except as expressly provided herein, no provision of this Debenture shall alter or impair the obligation of the Company, which is absolute and unconditional, to pay the principal of, liquidated damages and accrued interest, as applicable, on this Debenture at the time, place, and rate, and in the coin or currency, herein prescribed. This Debenture is a direct debt obligation of the Company. This Debenture ranks pari passu with all other Debentures now or hereafter issued under the terms set forth herein.

c) Lost or Mutilated Debenture. If this Debenture shall be mutilated, lost, stolen or destroyed, the Company shall execute and deliver, in exchange and substitution for and upon cancellation of a mutilated Debenture, or in lieu of or in substitution for a lost, stolen or destroyed Debenture, a new Debenture for the principal amount of this Debenture so mutilated, lost, stolen or destroyed, but only upon receipt of evidence of such loss, theft or destruction of such Debenture, and of the ownership hereof, reasonably satisfactory to the Company.

d) Governing Law. All questions concerning the construction, validity, enforcement and interpretation of this Debenture shall be governed by and construed and enforced in accordance with the internal laws of the State of New York, without regard to the principles of conflict of laws thereof. Each party agrees that all legal proceedings concerning the interpretation, enforcement and defense of the transactions contemplated by any of the Transaction Documents (whether brought against a party hereto or its respective Affiliates, directors, officers, shareholders, employees or agents) shall be commenced in the state and federal courts sitting in the City of New York, Borough of Manhattan (the “New York Courts”). Each party hereto hereby irrevocably submits to the exclusive jurisdiction of the New York Courts for the adjudication of any dispute hereunder or in connection herewith or with any transaction contemplated hereby or discussed herein (including with respect to the enforcement of any of the Transaction Documents), and hereby irrevocably waives, and agrees not to assert in any suit, action or proceeding, any claim that it is not personally subject to the jurisdiction of such New York Courts, or such New York Courts are improper or inconvenient venue for such proceeding. Each party hereby irrevocably waives personal service of process and consents to process being served in any such suit, action or proceeding by mailing a copy thereof via registered or certified mail or overnight delivery (with evidence of delivery) to such party at the address in effect for notices to it under this Debenture and agrees that such service shall constitute good and sufficient service of process and notice thereof. Nothing contained herein shall be deemed to limit in any way any right to serve process in any other manner permitted by applicable law. Each party hereto hereby irrevocably waives, to the fullest extent permitted by applicable law, any and all right to trial by jury in any legal proceeding arising out of or relating to this Debenture or the transactions contemplated hereby. If any party shall commence an action or proceeding to enforce any provisions of this Debenture, then the prevailing party in such action or proceeding shall be reimbursed by the other party for its attorneys fees and other costs and expenses incurred in the investigation, preparation and prosecution of such action or proceeding.

24

e) Waiver. Any waiver by the Company or the Holder of a breach of any provision of this Debenture shall not operate as or be construed to be a waiver of any other breach of such provision or of any breach of any other provision of this Debenture. The failure of the Company or the Holder to insist upon strict adherence to any term of this Debenture on one or more occasions shall not be considered a waiver or deprive that party of the right thereafter to insist upon strict adherence to that term or any other term of this Debenture on any other occasion. Any waiver by the Company or the Holder must be in writing.

f) Severability. If any provision of this Debenture is invalid, illegal or unenforceable, the balance of this Debenture shall remain in effect, and if any provision is inapplicable to any Person or circumstance, it shall nevertheless remain applicable to all other Persons and circumstances. If it shall be found that any interest or other amount deemed interest due hereunder violates the applicable law governing usury, the applicable rate of interest due hereunder shall automatically be lowered to equal the maximum rate of interest permitted under applicable law. The Company covenants (to the extent that it may lawfully do so) that it shall not at any time insist upon, plead, or in any manner whatsoever claim or take the benefit or advantage of, any stay, extension or usury law or other law which would prohibit or forgive the Company from paying all or any portion of the principal of or interest on this Debenture as contemplated herein, wherever enacted, now or at any time hereafter in force, or which may affect the covenants or the performance of this Debenture, and the Company (to the extent it may lawfully do so) hereby expressly waives all benefits or advantage of any such law, and covenants that it will not, by resort to any such law, hinder, delay or impede the execution of any power herein granted to the Holder, but will suffer and permit the execution of every such as though no such law has been enacted.

g) Remedies, Characterizations, Other Obligations, Breaches and Injunctive Relief. The remedies provided in this Debenture shall be cumulative and in addition to all other remedies available under this Debenture and any of the other Transaction Documents at law or in equity (including a decree of specific performance and/or other injunctive relief), and nothing herein shall limit the Holder’s right to pursue actual and consequential damages for any failure by the Company to comply with the terms of this Debenture. The Company covenants to the Holder that there shall be no characterization concerning this instrument other than as expressly provided herein. Amounts set forth or provided for herein with respect to payments, conversion and the like (and the computation thereof) shall be the amounts to be received by the Holder and shall not, except as expressly provided herein, be subject to any other obligation of the Company (or the performance thereof). The Company acknowledges that a breach by it of its obligations hereunder will cause irreparable harm to the Holder and that the remedy at law for any such breach may be inadequate. The Company therefore agrees that, in the event of any such breach or threatened breach, the Holder shall be entitled, in addition to all other available remedies, to an injunction restraining any such breach or any such threatened breach, without the necessity of showing economic loss and without any bond or other security being required. The Company shall provide all information and documentation to the Holder that is requested by the Holder to enable the Holder to confirm the Company’s compliance with the terms and conditions of this Debenture.

25

h) Next Business Day. Whenever any payment or other obligation hereunder shall be due on a day other than a Business Day, such payment shall be made on the next succeeding Business Day.

i) Headings. The headings contained herein are for convenience only, do not constitute a part of this Debenture and shall not be deemed to limit or affect any of the provisions hereof.

j) Secured Obligations. The obligations of the Company under this Debenture are secured by all assets of the Company and each Subsidiary pursuant to (i) the Pledge and Security Agreement, dated as of [] by and among the Company, the Subsidiaries of the Company, the Agent (as defined therein) and the Creditors (as defined therein) (as the same may be amended from time to time, the “Pledge and Security Agreement”) and (ii) the Intellectual Property Security Agreement, dated as of [] by and among the Company, the Subsidiaries of the Company, and the Agent (as defined therein) (as the same may be amended from time to time, the “Intellectual Property Security Agreement”).

k) Guaranteed Obligations. The obligations of the Company under this Debenture are guaranteed by each Subsidiary pursuant to the Subsidiary Guarantee, dated as of [], by and among the Subsidiaries of the Company (as the same may be amended from time to time, the “Subsidiary Guarantee”).

Section 10. New Subsidiaries. If the Company or any Subsidiary forms or acquires any new direct or indirect Subsidiary, or any Subsidiary merges, amalgamates, or consolidates with or into any other Person and such Subsidiary is not the surviving Person as a result of such merger, amalgamation, or consolidation (such surviving Person that is not a Subsidiary, the “Surviving Entity”), the Company agrees to, or to cause such Subsidiary or Surviving Entity to, concurrently with such formation, acquisition, merger, amalgamation or consolidation, (i) amend the Pledge and Security Agreement pursuant to a pledge and security agreement addendum attached as Exhibit B to the Pledge and Security Agreement to reflect the addition of such capital stock and pledge the applicable capital stock to Agent (as defined in the Pledge and Security Agreement) as additional collateral for the obligations of the Company under this Debenture, (ii) cause such newly formed or acquired Subsidiary or Surviving Entity to (A) become a party to the Subsidiary Guarantee pursuant to an assumption agreement in the form set forth on Annex 1 thereto, (B) become a party to the Pledge and Security Agreement pursuant to a joinder in form satisfactory to Agent for the purposes of granting a security interest in such Subsidiary’s or Surviving Entity’s assets as additional security for the obligations of the Company under this Debenture and (C) become a party to the Intellectual Property Security Agreement pursuant to a joinder in form satisfactory to Agent for the purposes of granting a security interest in such Subsidiary’s or Surviving Entity’s intellectual property as additional security for the obligations of the Company under this Debenture, (iii)

deliver to Agent an opinion of counsel in form and substance acceptable to Agent, among other things, the due authorization, due execution and delivery and enforceability of the foregoing documents with respect to such Subsidiary or Surviving Entity and (iv) to execute or deliver such other agreements, documents requested by the Agent in connection therewith.

Section 11. Disclosure. Upon receipt or delivery by the Company of any notice in accordance with the terms of this Debenture, unless the Company has in good faith determined that the matters relating to such notice do not constitute material, nonpublic information relating to the Company or its Subsidiaries, the Company shall within two (2) Business Days after such receipt or delivery publicly disclose such material, nonpublic information on a Current Report on Form 8-K or otherwise. In the event that the Company believes that a notice contains material, non-public information relating to the Company or its Subsidiaries, the Company so shall indicate to the Holder contemporaneously with delivery of such notice, and in the absence of any such indication, the Holder shall be allowed to presume that all matters relating to such notice do not constitute material, nonpublic information relating to the Company or its Subsidiaries.

(Signature Page Follows)

26

IN WITNESS WHEREOF, the Company has caused this Debenture to be duly executed by a duly authorized officer as of the date first above indicated.

NAUTICUS ROBOTICS, INC. (F/K/A CLEANTECH ACQUISITION CORP.)

By: _____
Name:
Title:

Facsimile No. for delivery of Notices: _____

27

ANNEX A

NOTICE OF CONVERSION

The undersigned hereby elects to convert principal under the 5% Original Issue Discount Senior Secured Convertible Debenture due _____ 2022 of _____, a Delaware corporation (the "Company"), into shares of common stock (the "Common Stock"), of the Company according to the conditions hereof, as of the date written below. If shares of Common Stock are to be issued in the name of a person other than the undersigned, the undersigned will pay all transfer taxes payable with respect thereto and is delivering herewith such certificates and opinions as reasonably requested by the Company in accordance therewith. No fee will be charged to the holder for any conversion, except for such transfer taxes, if any.

By the delivery of this Notice of Conversion the undersigned represents and warrants to the Company that its ownership of the Common Stock does not exceed the amounts specified under Section 4 of this Debenture, as determined in accordance with Section 13(d) of the Exchange Act.

The undersigned agrees to comply with the prospectus delivery requirements under the applicable securities laws in connection with any transfer of the aforesaid shares of Common Stock.

Conversion calculations:

Date to Effect Conversion:

Principal Amount of Debenture to be Converted:

Payment of Interest in Common Stock yes no

If yes, \$_____ of Interest Accrued on Account of Conversion at Issue.

Number of shares of Common Stock to be issued:

Signature:

Name:

Address for Delivery of Common Stock Certificates:

Or

DWAC Instructions:

Broker No: _____

Account No: _____

28

Schedule 1

CONVERSION SCHEDULE

The 5% Original Issue Discount Senior Secured Convertible Debentures due on _____ 2022 in the aggregate principal amount of \$ _____ are issued by _____, a Delaware corporation. This Conversion Schedule reflects conversions made under Section 4 of the above referenced Debenture.

Dated:

Date of Conversion (or for first entry, Original Issue Date)	Amount of Conversion	Aggregate Principal Amount Remaining Subsequent to Conversion (or original Principal Amount)	Company Attest

NEITHER THIS SECURITY NOR THE SECURITIES FOR WHICH THIS SECURITY IS EXERCISABLE HAVE BEEN REGISTERED WITH THE SECURITIES AND EXCHANGE COMMISSION OR THE SECURITIES COMMISSION OF ANY STATE IN RELIANCE UPON AN EXEMPTION FROM REGISTRATION UNDER THE SECURITIES ACT OF 1933, AS AMENDED (THE "SECURITIES ACT"), AND, ACCORDINGLY, MAY NOT BE OFFERED OR SOLD EXCEPT PURSUANT TO AN EFFECTIVE REGISTRATION STATEMENT UNDER THE SECURITIES ACT OR PURSUANT TO AN AVAILABLE EXEMPTION FROM, OR IN A TRANSACTION NOT SUBJECT TO, THE REGISTRATION REQUIREMENTS OF THE SECURITIES ACT AND IN ACCORDANCE WITH APPLICABLE STATE SECURITIES LAWS. THIS SECURITY AND THE SECURITIES ISSUABLE UPON EXERCISE OF THIS SECURITY MAY BE PLEDGED IN CONNECTION WITH A BONA FIDE MARGIN ACCOUNT OR OTHER LOAN SECURED BY SUCH SECURITIES.

COMMON STOCK PURCHASE WARRANT

CLEANTECH ACQUISITION CORP.

Warrant Shares: _____

Initial Exercise Date: _____, 2022

THIS COMMON STOCK PURCHASE WARRANT (the "Warrant") certifies that, for value received, _____ or its assigns (the "Holder") is entitled, upon the terms and subject to the limitations on exercise and the conditions hereinafter set forth, at any time on or after the date hereof (the "Initial Exercise Date") and on or prior to 5:00 p.m. (New York City time) on _____ 2032¹ (the "Termination Date") but not thereafter, to subscribe for and purchase from Cleantech Acquisition Corp., a Delaware corporation (the "Company"), up to shares (as subject to adjustment hereunder, the "Warrant Shares") of Common Stock. The purchase price of one share of Common Stock under this Warrant shall be equal to the Exercise Price, as defined in Section 2(b).

Section 1. Definitions. Capitalized terms used and not otherwise defined herein shall have the meanings set forth in that certain Securities Purchase Agreement (the "Purchase Agreement"), dated December 16, 2021, among the Company and the purchasers signatory thereto.

Section 2. Exercise.

a) Exercise of Warrant. Exercise of the purchase rights represented by this Warrant may be made, in whole or in part, at any time or times on or after the Initial Exercise Date and on or before the Termination Date by delivery to the Company of a duly executed facsimile copy or PDF copy submitted by e-mail (or e-mail attachment) of the Notice of Exercise in the form annexed hereto (the "Notice of Exercise"). Within the earlier of (i) two (2) Trading Days and (ii) the number of Trading Days comprising the Standard Settlement Period (as defined in Section 2(d)(i) herein) following the date of exercise as aforesaid, the Holder shall deliver the aggregate Exercise Price for the shares specified in the applicable Notice of Exercise by wire transfer or cashier's check drawn on a United States bank unless the cashless exercise procedure specified in Section 2(c) below is specified in the applicable Notice of Exercise. No ink-original Notice of Exercise shall be required, nor shall any medallion guarantee (or other type of guarantee or notarization) of any Notice of Exercise be required. Notwithstanding anything herein to the contrary, the Holder shall not be required to physically surrender this Warrant to the Company until the Holder has purchased all of the Warrant Shares available hereunder and the Warrant has been exercised in full, in which case, the Holder shall surrender this Warrant to the Company for cancellation within three (3) Trading Days of the date on which the final Notice of Exercise is delivered to the Company. Partial exercises of this Warrant resulting in purchases of a portion of the total number of Warrant Shares available hereunder shall have the effect of lowering the outstanding number of Warrant Shares purchasable hereunder in an amount equal to the applicable number of Warrant Shares purchased. The Holder and the Company shall maintain records showing the number of Warrant Shares purchased and the date of such purchases. The Company shall deliver any objection to any Notice of Exercise within one (1) Business Day of receipt of such notice. **The Holder and any assignee, by acceptance of this Warrant, acknowledge and agree that, by reason of the provisions of this paragraph, following the purchase of a portion of the Warrant Shares hereunder, the number of Warrant Shares available for purchase hereunder at any given time may be less than the amount stated on the face hereof.**

¹ 10 years.

b) Exercise Price. The exercise price per share of Common Stock under this Warrant shall be **\$20.00**, subject to adjustment hereunder (the "Exercise Price").

c) Cashless Exercise. If at the time of exercise hereof there is no effective registration statement registering, or the prospectus contained therein is not available for the resale of the Warrant Shares by the Holder, then this Warrant may also be exercised, in whole or in part, at such time by means of a "cashless exercise" in which the Holder shall be entitled to receive a number of Warrant Shares equal to the quotient obtained by dividing [(A-B) (X)] by (A), where:

(A) = as applicable: (i) the VWAP on the Trading Day immediately preceding the date of the applicable Notice of Exercise if such Notice of Exercise is (1) both executed and delivered pursuant to Section 2(a) hereof on a day that is not a Trading Day or (2) both executed and delivered pursuant to Section 2(a) hereof on a Trading Day prior to the opening of "regular trading hours" (as defined in Rule 600(b) of Regulation NMS promulgated under the federal securities laws) on such Trading Day, (ii) at the option of the Holder, either (y) the VWAP on the Trading Day immediately preceding the date of the applicable Notice of Exercise or (z) the Bid Price of the Common Stock on the principal Trading Market as reported by Bloomberg L.P. ("Bloomberg") as of the time of the Holder's execution of the applicable Notice of Exercise if such Notice of Exercise is executed during "regular trading hours" on a Trading Day and is delivered within two (2) hours thereafter (including until two (2) hours after the close of "regular trading hours" on a Trading Day) pursuant to Section 2(a) hereof or (iii) the VWAP on the date of the applicable Notice of Exercise if the date of such Notice of Exercise is a Trading Day and such Notice of Exercise is both executed and delivered pursuant to Section 2(a) hereof after the close of "regular trading hours" on such Trading Day;

(B) = the Exercise Price of this Warrant, as adjusted hereunder; and

(X) = the number of Warrant Shares that would be issuable upon exercise of this Warrant in accordance with the terms of this Warrant if such exercise were by means of a cash exercise rather than a cashless exercise.

If Warrant Shares are issued in such a cashless exercise, the parties acknowledge and agree that in accordance with Section 3(a)(9) of the Securities Act, the Warrant Shares shall take on the characteristics of the Warrants being exercised, and the holding period of the Warrant Shares being issued may be tacked on to the holding period of this Warrant. The Company agrees not to take any position contrary to this Section 2(c).

"Bid Price" means, for any date, the price determined by the first of the following clauses that applies: (a) if the Common Stock is then listed or quoted on a

Trading Market, the bid price of the Common Stock for the time in question (or the nearest preceding date) on the Trading Market on which the Common Stock is then listed or quoted as reported by Bloomberg (based on a Trading Day from 9:30 a.m. (New York City time) to 4:02 p.m. (New York City time)), (b) if OTCQB or OTCQX is not a Trading Market, the volume weighted average price of the Common Stock for such date (or the nearest preceding date) on OTCQB or OTCQX as applicable, (c) if the Common Stock is not then listed or quoted for trading on OTCQB or OTCQX and if prices for the Common Stock are then reported on The Pink Open Market (or a similar organization or agency succeeding to its functions of reporting prices), the most recent bid price per share of the Common Stock so reported, or (d) in all other cases, the fair market value of a share of Common Stock as determined by an independent appraiser selected in good faith by the Purchasers of a majority in interest of the Securities then outstanding and reasonably acceptable to the Company, the fees and expenses of which shall be paid by the Company.

“VWAP” means, for any date, the price determined by the first of the following clauses that applies: (a) if the Common Stock is then listed or quoted on a Trading Market, the daily volume weighted average price of the Common Stock for such date (or the nearest preceding date) on the Trading Market on which the Common Stock is then listed or quoted as reported by Bloomberg (based on a Trading Day from 9:30 a.m. (New York City time) to 4:02 p.m. (New York City time)), (b) if OTCQB or OTCQX is not a Trading Market, the volume weighted average price of the Common Stock for such date (or the nearest preceding date) on OTCQB or OTCQX as applicable, (c) if the Common Stock is not then listed or quoted for trading on OTCQB or OTCQX and if prices for the Common Stock are then reported in The Pink Open Market (or a similar organization or agency succeeding to its functions of reporting prices), the most recent bid price per share of the Common Stock so reported, or (d) in all other cases, the fair market value of a share of Common Stock as determined by an independent appraiser selected in good faith by the Purchasers of a majority in interest of the Securities then outstanding and reasonably acceptable to the Company, the fees and expenses of which shall be paid by the Company.

Notwithstanding anything herein to the contrary, on the Termination Date, this Warrant shall be automatically exercised via cashless exercise pursuant to this Section 2(c).

3

d) Mechanics of Exercise.

i. Delivery of Warrant Shares Upon Exercise. The Company shall cause the Warrant Shares purchased hereunder to be transmitted by the Transfer Agent to the Holder by crediting the account of the Holder’s or its designee’s balance account with The Depository Trust Company through its Deposit or Withdrawal at Custodian system (“DWAC”) if the Company is then a participant in such system and either (A) there is an effective registration statement permitting the issuance of the Warrant Shares to or resale of the Warrant Shares by the Holder or (B) the Warrant Shares are eligible for resale by the Holder without volume or manner-of-sale limitations pursuant to Rule 144 (assuming cashless exercise of the Warrants), and otherwise by physical delivery of a certificate, registered in the Company’s share register in the name of the Holder or its designee, for the number of Warrant Shares to which the Holder is entitled pursuant to such exercise to the address specified by the Holder in the Notice of Exercise by the date that is the earliest of (i) two (2) Trading Days after the delivery to the Company of the Notice of Exercise, (ii) one (1) Trading Day after delivery of the aggregate Exercise Price to the Company and (iii) the number of Trading Days comprising the Standard Settlement Period after the delivery to the Company of the Notice of Exercise (such date, the “Warrant Share Delivery Date”). Upon delivery of the Notice of Exercise, the Holder shall be deemed for all corporate purposes to have become the holder of record of the Warrant Shares with respect to which this Warrant has been exercised, irrespective of the date of delivery of the Warrant Shares, provided that payment of the aggregate Exercise Price (other than in the case of a cashless exercise) is received within the earlier of (i) two (2) Trading Days and (ii) the number of Trading Days comprising the Standard Settlement Period following delivery of the Notice of Exercise. If the Company fails for any reason to deliver to the Holder the Warrant Shares subject to a Notice of Exercise by the Warrant Share Delivery Date, the Company shall pay to the Holder, in cash, as liquidated damages and not as a penalty, for each \$1,000 of Warrant Shares subject to such exercise (based on the VWAP of the Common Stock on the date of the applicable Notice of Exercise), \$10 per Trading Day (increasing to \$20 per Trading Day on the third Trading Day after the Warrant Share Delivery Date) for each Trading Day after such Warrant Share Delivery Date until such Warrant Shares are delivered or Holder rescinds such exercise. The Company agrees to maintain a transfer agent that is a participant in the FAST program so long as this Warrant remains outstanding and exercisable. As used herein, “Standard Settlement Period” means the standard settlement period, expressed in a number of Trading Days, on the Company’s primary Trading Market with respect to the Common Stock as in effect on the date of delivery of the Notice of Exercise.

ii. Delivery of New Warrants Upon Exercise. If this Warrant shall have been exercised in part, the Company shall, at the request of a Holder and upon surrender of this Warrant certificate, at the time of delivery of the Warrant Shares, deliver to the Holder a new Warrant evidencing the rights of the Holder to purchase the unpurchased Warrant Shares called for by this Warrant, which new Warrant shall in all other respects be identical with this Warrant.

4

iii. Rescission Rights. If the Company fails to cause the Transfer Agent to transmit to the Holder the Warrant Shares pursuant to Section 2(d)(i) by the Warrant Share Delivery Date, then the Holder will have the right to rescind such exercise.

iv. Compensation for Buy-In on Failure to Timely Deliver Warrant Shares Upon Exercise. In addition to any other rights available to the Holder, if the Company fails to cause the Transfer Agent to transmit to the Holder the Warrant Shares in accordance with the provisions of Section 2(d)(i) above pursuant to an exercise on or before the Warrant Share Delivery Date, and if after such date the Holder is required by its broker to purchase (in an open market transaction or otherwise) or the Holder’s brokerage firm otherwise purchases, shares of Common Stock to deliver in satisfaction of a sale by the Holder of the Warrant Shares which the Holder anticipated receiving upon such exercise (a “Buy-In”), then the Company shall (A) pay in cash to the Holder the amount, if any, by which (x) the Holder’s total purchase price (including brokerage commissions, if any) for the shares of Common Stock so purchased exceeds (y) the amount obtained by multiplying (1) the number of Warrant Shares that the Company was required to deliver to the Holder in connection with the exercise at issue times (2) the price at which the sell order giving rise to such purchase obligation was executed, and (B) at the option of the Holder, either reinstate the portion of the Warrant and equivalent number of Warrant Shares for which such exercise was not honored (in which case such exercise shall be deemed rescinded) or deliver to the Holder the number of shares of Common Stock that would have been issued had the Company timely complied with its exercise and delivery obligations hereunder. For example, if the Holder purchases Common Stock having a total purchase price of \$11,000 to cover a Buy-In with respect to an attempted exercise of shares of Common Stock with an aggregate sale price giving rise to such purchase obligation of \$10,000, under clause (A) of the immediately preceding sentence the Company shall be required to pay the Holder \$1,000. The Holder shall provide the Company written notice indicating the amounts payable to the Holder in respect of the Buy-In and, upon request of the Company, evidence of the amount of such loss. Nothing herein shall limit a Holder’s right to pursue any other remedies available to it hereunder, at law or in equity including, without limitation, a decree of specific performance and/or injunctive relief with respect to the Company’s failure to timely deliver shares of Common Stock upon exercise of the Warrant as required pursuant to the terms hereof.

v. No Fractional Shares or Scrip. No fractional shares or scrip representing fractional shares shall be issued upon the exercise of this Warrant. As to any fraction of a share which the Holder would otherwise be entitled to purchase upon such exercise, the Company shall, at its election, either

pay a cash adjustment in respect of such final fraction in an amount equal to such fraction multiplied by the Exercise Price or round up to the next whole share.

vi. Charges, Taxes and Expenses. Issuance of Warrant Shares shall be made without charge to the Holder for any issue or transfer tax or other incidental expense in respect of the issuance of such Warrant Shares, all of which taxes and expenses shall be paid by the Company, and such Warrant Shares shall be issued in the name of the Holder or in such name or names as may be directed by the Holder; provided, however, that, in the event that Warrant Shares are to be issued in a name other than the name of the Holder, this Warrant when surrendered for exercise shall be accompanied by the Assignment Form attached hereto duly executed by the Holder and the Company may require, as a condition thereto, the payment of a sum sufficient to reimburse it for any transfer tax incidental thereto. The Company shall pay all Transfer Agent fees required for same-day processing of any Notice of Exercise and all fees to the Depository Trust Company (or another established clearing corporation performing similar functions) required for same-day electronic delivery of the Warrant Shares.

5

vii. Closing of Books. The Company will not close its stockholder books or records in any manner which prevents the timely exercise of this Warrant, pursuant to the terms hereof.

e) Holder's Exercise Limitations. The Company shall not effect any exercise of this Warrant, and a Holder shall not have the right to exercise any portion of this Warrant, pursuant to Section 2 or otherwise, to the extent that after giving effect to such issuance after exercise as set forth on the applicable Notice of Exercise, the Holder (together with the Holder's Affiliates, and any other Persons acting as a group together with the Holder or any of the Holder's Affiliates (such Persons, "Attribution Parties")), would beneficially own in excess of the Beneficial Ownership Limitation (as defined below). For purposes of the foregoing sentence, the number of shares of Common Stock beneficially owned by the Holder and its Affiliates and Attribution Parties shall include the number of shares of Common Stock issuable upon exercise of this Warrant with respect to which such determination is being made, but shall exclude the number of shares of Common Stock which would be issuable upon (i) exercise of the remaining, nonexercised portion of this Warrant beneficially owned by the Holder or any of its Affiliates or Attribution Parties and (ii) exercise or conversion of the unexercised or nonconverted portion of any other securities of the Company (including, without limitation, any other Common Stock Equivalents) subject to a limitation on conversion or exercise analogous to the limitation contained herein beneficially owned by the Holder or any of its Affiliates or Attribution Parties. Except as set forth in the preceding sentence, for purposes of this Section 2(e), beneficial ownership shall be calculated in accordance with Section 13(d) of the Exchange Act and the rules and regulations promulgated thereunder, it being acknowledged by the Holder that the Company is not representing to the Holder that such calculation is in compliance with Section 13(d) of the Exchange Act and the Holder is solely responsible for any schedules required to be filed in accordance therewith. To the extent that the limitation contained in this Section 2(e) applies, the determination of whether this Warrant is exercisable (in relation to other securities owned by the Holder together with any Affiliates and Attribution Parties) and of which portion of this Warrant is exercisable shall be in the sole discretion of the Holder, and the submission of a Notice of Exercise shall be deemed to be the Holder's determination of whether this Warrant is exercisable (in relation to other securities owned by the Holder together with any Affiliates and Attribution Parties) and of which portion of this Warrant is exercisable, in each case subject to the Beneficial Ownership Limitation, and the Company shall have no obligation to verify or confirm the accuracy of such determination. In addition, a determination as to any group status as contemplated above shall be determined in accordance with Section 13(d) of the Exchange Act and the rules and regulations promulgated thereunder. For purposes of this Section 2(e), in determining the number of outstanding shares of Common Stock, a Holder may rely on the number of outstanding shares of Common Stock as reflected in (A) the Company's most recent periodic or annual report filed with the Commission, as the case may be, (B) a more recent public announcement by the Company or (C) a more recent written notice by the Company or the Transfer Agent setting forth the number of shares of Common Stock outstanding. Upon the written or oral request of a Holder, the Company shall within one Trading Day confirm orally and in writing to the Holder the number of shares of Common Stock then outstanding. In any case, the number of outstanding shares of Common Stock shall be determined after giving effect to the conversion or exercise of securities of the Company, including this Warrant, by the Holder or its Affiliates or Attribution Parties since the date as of which such number of outstanding shares of Common Stock was reported. The "Beneficial Ownership Limitation" shall be [9.99/4.99%] of the number of shares of the Common Stock outstanding immediately after giving effect to the issuance of shares of Common Stock issuable upon exercise of this Warrant. The Holder, upon notice to the Company, may increase or decrease the Beneficial Ownership Limitation provisions of this Section 2(e), provided that the Beneficial Ownership Limitation in no event exceeds 9.99% of the number of shares of the Common Stock outstanding immediately after giving effect to the issuance of shares of Common Stock upon exercise of this Warrant held by the Holder and the provisions of this Section 2(e) shall continue to apply. Any increase in the Beneficial Ownership Limitation will not be effective until the 61st day after such notice is delivered to the Company. The provisions of this paragraph shall be construed and implemented in a manner otherwise than in strict conformity with the terms of this Section 2(e) to correct this paragraph (or any portion hereof) which may be defective or inconsistent with the intended Beneficial Ownership Limitation herein contained or to make changes or supplements necessary or desirable to properly give effect to such limitation. The limitations contained in this paragraph shall apply to a successor holder of this Warrant.

6

Section 3. Certain Adjustments.

a) Stock Dividends and Splits. If the Company, at any time while this Warrant is outstanding: (i) pays a stock dividend or otherwise makes a distribution or distributions on shares of its Common Stock or any other equity or equity equivalent securities payable in shares of Common Stock (which, for avoidance of doubt, shall not include any shares of Common Stock issued by the Company upon exercise of this Warrant), (ii) subdivides outstanding shares of Common Stock into a larger number of shares, (iii) combines (including by way of reverse stock split) outstanding shares of Common Stock into a smaller number of shares, or (iv) issues by reclassification of shares of the Common Stock any shares of capital stock of the Company, then in each case the Exercise Price shall be multiplied by a fraction of which the numerator shall be the number of shares of Common Stock (excluding treasury shares, if any) outstanding immediately before such event and of which the denominator shall be the number of shares of Common Stock outstanding immediately after such event, and the number of shares issuable upon exercise of this Warrant shall be proportionately adjusted such that the aggregate Exercise Price of this Warrant shall remain unchanged. Any adjustment made pursuant to this Section 3(a) shall become effective immediately after the record date for the determination of stockholders entitled to receive such dividend or distribution and shall become effective immediately after the effective date in the case of a subdivision, combination or re-classification.

b) Subsequent Equity Sales. If the Company or any Subsidiary thereof, as applicable, at any time while this Warrant is outstanding, shall sell, enter into an agreement to sell, or grant any option to purchase, or sell or grant any right to repurchase, or otherwise dispose of or issue (or announce any offer, sale, grant or any option to purchase or other disposition) any Common Stock or Common Stock Equivalents, at an effective price per share less than the Exercise Price then in effect (such lower price, the "Base Share Price" and such issuances collectively, a "Dilutive Issuance") (it being understood and agreed that if the holder of the Common Stock or Common Stock Equivalents so issued shall at any time, whether by operation of purchase price adjustments, reset provisions, floating conversion, exercise or exchange prices or otherwise, or due to warrants, options or rights per share which are issued in connection with such issuance, be entitled to receive shares of Common Stock at an effective price per share that is less than the Exercise Price, such issuance shall be deemed to have occurred for less than the Exercise Price on such date of the Dilutive Issuance at such effective price), then simultaneously with the consummation (or, if earlier, the announcement) of each Dilutive Issuance the Exercise Price shall be reduced and only reduced to equal the Base Share Price and the number of Warrant Shares issuable hereunder shall be increased such that the aggregate Exercise Price payable hereunder, after taking into account the decrease in the Exercise Price, shall be equal to the aggregate Exercise Price prior to such adjustment, provided that the

Base Share Price shall not be less than \$2.00 (subject to adjustment for reverse and forward stock splits, recapitalizations and similar transactions following the date of the Purchase Agreement). Notwithstanding the foregoing, no adjustments shall be made, paid or issued under this Section 3(b) in respect of an Exempt Issuance. The Company shall notify the Holder, in writing, no later than the Trading Day following the issuance or deemed issuance of any Common Stock or Common Stock Equivalents subject to this Section 3(b), indicating therein the applicable issuance price, or applicable reset price, exchange price, conversion price and other pricing terms (such notice, the “Dilutive Issuance Notice”). For purposes of clarification, whether or not the Company provides a Dilutive Issuance Notice pursuant to this Section 3(b), upon the occurrence of any Dilutive Issuance, the Holder is entitled to receive a number of Warrant Shares based upon the Base Share Price regardless of whether the Holder accurately refers to the Base Share Price in the Notice of Exercise. If the Company enters into a Variable Rate Transaction, the Company shall be deemed to have issued Common Stock or Common Stock Equivalents at the lowest possible price, conversion price or exercise price at which such securities may be issued, converted or exercised.

7

c) Subsequent Rights Offerings. In addition to any adjustments pursuant to Section 3(a) above, if at any time the Company grants, issues or sells any Common Stock Equivalents or rights to purchase stock, warrants, securities or other property pro rata to the record holders of any class of shares of Common Stock (the “Purchase Rights”), then the Holder will be entitled to acquire, upon the terms applicable to such Purchase Rights, the aggregate Purchase Rights which the Holder could have acquired if the Holder had held the number of shares of Common Stock acquirable upon complete exercise of this Warrant (without regard to any limitations on exercise hereof, including without limitation, the Beneficial Ownership Limitation) immediately before the date on which a record is taken for the grant, issuance or sale of such Purchase Rights, or, if no such record is taken, the date as of which the record holders of shares of Common Stock are to be determined for the grant, issue or sale of such Purchase Rights (provided, however, that, to the extent that the Holder’s right to participate in any such Purchase Right would result in the Holder exceeding the Beneficial Ownership Limitation, then the Holder shall not be entitled to participate in such Purchase Right to such extent (or beneficial ownership of such shares of Common Stock as a result of such Purchase Right to such extent) and such Purchase Right to such extent shall be held in abeyance for the Holder until such time, if ever, as its right thereto would not result in the Holder exceeding the Beneficial Ownership Limitation).

d) Pro Rata Distributions. During such time as this Warrant is outstanding, if the Company shall declare or make any dividend or other distribution of its assets (or rights to acquire its assets) to holders of shares of Common Stock, by way of return of capital or otherwise (including, without limitation, any distribution of cash, stock or other securities, property or options by way of a dividend, spin off, reclassification, corporate rearrangement, scheme of arrangement or other similar transaction) (a “Distribution”), at any time after the issuance of this Warrant, then, in each such case, the Holder shall be entitled to participate in such Distribution to the same extent that the Holder would have participated therein if the Holder had held the number of shares of Common Stock acquirable upon complete exercise of this Warrant (without regard to any limitations on exercise hereof, including without limitation, the Beneficial Ownership Limitation) immediately before the date of which a record is taken for such Distribution, or, if no such record is taken, the date as of which the record holders of shares of Common Stock are to be determined for the participation in such Distribution (provided, however, that, to the extent that the Holder’s right to participate in any such Distribution would result in the Holder exceeding the Beneficial Ownership Limitation, then the Holder shall not be entitled to participate in such Distribution to such extent (or in the beneficial ownership of any shares of Common Stock as a result of such Distribution to such extent) and the portion of such Distribution shall be held in abeyance for the benefit of the Holder until such time, if ever, as its right thereto would not result in the Holder exceeding the Beneficial Ownership Limitation). To the extent that this Warrant has not been partially or completely exercised at the time of such Distribution, such portion of the Distribution shall be held in abeyance for the benefit of the Holder until the Holder has exercised this Warrant.

8

e) Fundamental Transaction. If, at any time while this Warrant is outstanding, (i) the Company, directly or indirectly, in one or more related transactions effects any merger or consolidation of the Company with or into another Person, (ii) the Company (or any Subsidiary), directly or indirectly, effects any sale, lease, license, assignment, transfer, conveyance or other disposition of all or substantially all of its assets in one or a series of related transactions, (iii) any, direct or indirect, purchase offer, tender offer or exchange offer (whether by the Company or another Person) is completed pursuant to which holders of Common Stock are permitted to sell, tender or exchange their shares for other securities, cash or property and has been accepted by the holders of 50% or more of the outstanding Common Stock, (iv) the Company, directly or indirectly, in one or more related transactions effects any reclassification, reorganization or recapitalization of the Common Stock or any compulsory share exchange pursuant to which the Common Stock is effectively converted into or exchanged for other securities, cash or property, or (v) the Company, directly or indirectly, in one or more related transactions consummates a stock or share purchase agreement or other business combination (including, without limitation, a reorganization, recapitalization, spin-off, merger or scheme of arrangement) with another Person or group of Persons whereby such other Person or group acquires more than 50% of the outstanding shares of Common Stock (not including any shares of Common Stock held by the other Person or other Persons making or party to, or associated or affiliated with the other Persons making or party to, such stock or share purchase agreement or other business combination) (each a “Fundamental Transaction”), then, upon any subsequent exercise of this Warrant, the Holder shall have the right to receive, for each Warrant Share that would have been issuable upon such exercise immediately prior to the occurrence of such Fundamental Transaction, at the option of the Holder (without regard to any limitation in Section 2(e) on the exercise of this Warrant), the number of shares of Common Stock of the successor or acquiring corporation or of the Company, if it is the surviving corporation, and any additional consideration (the “Alternate Consideration”) receivable as a result of such Fundamental Transaction by a holder of the number of shares of Common Stock for which this Warrant is exercisable immediately prior to such Fundamental Transaction (without regard to any limitation in Section 2(e) on the exercise of this Warrant). For purposes of any such exercise, the determination of the Exercise Price shall be appropriately adjusted to apply to such Alternate Consideration based on the amount of Alternate Consideration issuable in respect of one share of Common Stock in such Fundamental Transaction, and the Company shall apportion the Exercise Price among the Alternate Consideration in a reasonable manner reflecting the relative value of any different components of the Alternate Consideration. If holders of Common Stock are given any choice as to the securities, cash or property to be received in a Fundamental Transaction, then the Holder shall be given the same choice as to the Alternate Consideration it receives upon any exercise of this Warrant following such Fundamental Transaction. Notwithstanding anything to the contrary, in the event of a Fundamental Transaction, the Company or any Successor Entity (as defined below) shall, at the Holder’s option, exercisable at any time concurrently with, or within 30 days after, the consummation of the Fundamental Transaction (or, if later, the date of the public announcement of the applicable Fundamental Transaction), purchase this Warrant from the Holder by paying to the Holder an amount of cash equal to the Black Scholes Value (as defined below) of the remaining unexercised portion of this Warrant on the date of the consummation of such Fundamental Transaction; provided, however, that, if the Fundamental Transaction is not within the Company’s control, including not approved by the Company’s Board of Directors, Holder shall only be entitled to receive from the Company or any Successor Entity the same type or form of consideration (and in the same proportion), at the Black Scholes Value of the unexercised portion of this Warrant, that is being offered and paid to the holders of Common Stock of the Company in connection with the Fundamental Transaction, whether that consideration be in the form of cash, stock or any combination thereof, or whether the holders of Common Stock are given the choice to receive from among alternative forms of consideration in connection with the Fundamental Transaction; provided, further, that if holders of Common Stock of the Company are not offered or paid any consideration in such Fundamental Transaction, such holders of Common Stock will be deemed to have received common stock of the Successor Entity (which Entity may be the Company following such Fundamental Transaction) in such Fundamental Transaction. “Black Scholes Value” means the value of this Warrant based on the Black-Scholes Option Pricing Model obtained from the “OV” function on Bloomberg determined as of the day of consummation of the applicable Fundamental Transaction for pricing purposes and reflecting (A) a risk-free interest rate corresponding to the U.S. Treasury rate for a period equal to the time between the date of the public announcement of the applicable Fundamental Transaction and the Termination Date, (B) an expected volatility equal to the greater of 100% and the 100 day volatility obtained from the HVT function on Bloomberg (determined utilizing a 365 day annualization factor) as of the Trading Day immediately following the public announcement of the applicable Fundamental Transaction, (C) the underlying price per share used in such calculation shall be the greater of (i) the sum of the price per share being offered in cash, if any, plus the value of any non-cash consideration, if any, being offered in such Fundamental Transaction and (ii) the highest VWAP during

the period beginning on the Trading Day immediately preceding the announcement of the applicable Fundamental Transaction (or the consummation of the applicable Fundamental Transaction, if earlier) and ending on the Trading Day of the Holder's request pursuant to this Section 3(e) and (D) a remaining option time equal to the time between the date of the public announcement of the applicable Fundamental Transaction and the Termination Date and (E) a zero cost of borrow. The payment of the Black Scholes Value will be made by wire transfer of immediately available funds (or such other consideration) within the later of (i) five Business Days of the Holder's election and (ii) the date of consummation of the Fundamental Transaction. The Company shall cause any successor entity in a Fundamental Transaction in which the Company is not the survivor (the "Successor Entity") to assume in writing all of the obligations of the Company under this Warrant and the other Transaction Documents in accordance with the provisions of this Section 3(e) pursuant to written agreements in form and substance reasonably satisfactory to the Holder and approved by the Holder (without unreasonable delay) prior to such Fundamental Transaction and shall, at the option of the Holder, deliver to the Holder in exchange for this Warrant a security of the Successor Entity evidenced by a written instrument substantially similar in form and substance to this Warrant which is exercisable for a corresponding number of shares of capital stock of such Successor Entity (or its parent entity) equivalent to the shares of Common Stock acquirable and receivable upon exercise of this Warrant (without regard to any limitations on the exercise of this Warrant) prior to such Fundamental Transaction, and with an exercise price which applies the exercise price hereunder to such shares of capital stock (but taking into account the relative value of the shares of Common Stock pursuant to such Fundamental Transaction and the value of such shares of capital stock, such number of shares of capital stock and such exercise price being for the purpose of protecting the economic value of this Warrant immediately prior to the consummation of such Fundamental Transaction), and which is reasonably satisfactory in form and substance to the Holder. Upon the occurrence of any such Fundamental Transaction, the Successor Entity shall succeed to, and be substituted for (so that from and after the date of such Fundamental Transaction, the provisions of this Warrant and the other Transaction Documents referring to the "Company" shall refer instead to the Successor Entity), and may exercise every right and power of the Company and shall assume all of the obligations of the Company under this Warrant and the other Transaction Documents with the same effect as if such Successor Entity had been named as the Company herein.

f) Calculations. All calculations under this Section 3 shall be made to the nearest cent or the nearest 1/100th of a share, as the case may be. For purposes of this Section 3, the number of shares of Common Stock deemed to be issued and outstanding as of a given date shall be the sum of the number of shares of Common Stock (excluding treasury shares, if any) issued and outstanding.

g) Notice to Holder.

i. Adjustment to Exercise Price. Whenever the Exercise Price is adjusted pursuant to any provision of this Section 3, the Company shall promptly deliver to the Holder by facsimile or email a notice setting forth the Exercise Price after such adjustment and any resulting adjustment to the number of Warrant Shares and setting forth a brief statement of the facts requiring such adjustment.

ii. Notice to Allow Exercise by Holder. If (A) the Company shall declare a dividend (or any other distribution in whatever form) on the Common Stock, (B) the Company shall declare a special nonrecurring cash dividend on or a redemption of the Common Stock, (C) the Company shall authorize the granting to all holders of the Common Stock rights or warrants to subscribe for or purchase any shares of capital stock of any class or of any rights, (D) the approval of any stockholders of the Company shall be required in connection with any reclassification of the Common Stock, any consolidation or merger to which the Company (or any of its Subsidiaries) is a party, any sale or transfer of all or substantially all of its assets, or any compulsory share exchange whereby the Common Stock is converted into other securities, cash or property, or (E) the Company shall authorize the voluntary or involuntary dissolution, liquidation or winding up of the affairs of the Company, then, in each case, the Company shall cause to be delivered by facsimile or email to the Holder at its last facsimile number or email address as it shall appear upon the Warrant Register of the Company, at least 20 calendar days prior to the applicable record or effective date hereinafter specified, a notice stating (x) the date on which a record is to be taken for the purpose of such dividend, distribution, redemption, rights or warrants, or if a record is not to be taken, the date as of which the holders of the Common Stock of record to be entitled to such dividend, distributions, redemption, rights or warrants are to be determined or (y) the date on which such reclassification, consolidation, merger, sale, transfer or share exchange is expected to become effective or close, and the date as of which it is expected that holders of the Common Stock of record shall be entitled to exchange their shares of the Common Stock for securities, cash or other property deliverable upon such reclassification, consolidation, merger, sale, transfer or share exchange; provided that the failure to deliver such notice or any defect therein or in the delivery thereof shall not affect the validity of the corporate action required to be specified in such notice. To the extent that any notice provided in this Warrant constitutes, or contains, material, non-public information regarding the Company or any of the Subsidiaries, the Company shall simultaneously file such notice with the Commission pursuant to a Current Report on Form 8-K. The Holder shall remain entitled to exercise this Warrant during the period commencing on the date of such notice to the effective date of the event triggering such notice except as may otherwise be expressly set forth herein.

h) Voluntary Adjustment By Company. Subject to the rules and regulations of the Trading Market, the Company may at any time during the term of this Warrant, subject to the prior written consent of the Holder, reduce the then current Exercise Price to any amount and for any period of time deemed appropriate by the board of directors of the Company.

Section 4. Transfer of Warrant.

a) Transferability. Subject to compliance with any applicable securities laws and the conditions set forth in Section 4(d) hereof and to the provisions of Section 4.1 of the Purchase Agreement, this Warrant and all rights hereunder (including, without limitation, any registration rights) are transferable, in whole or in part, upon surrender of this Warrant at the principal office of the Company or its designated agent, together with a written assignment of this Warrant substantially in the form attached hereto duly executed by the Holder or its agent or attorney and funds sufficient to pay any transfer taxes payable upon the making of such transfer. Upon such surrender and, if required, such payment, the Company shall execute and deliver a new Warrant or Warrants in the name of the assignee or assignees, as applicable, and in the denomination or denominations specified in such instrument of assignment, and shall issue to the assignor a new Warrant evidencing the portion of this Warrant not so assigned, and this Warrant shall promptly be cancelled. Notwithstanding anything herein to the contrary, the Holder shall not be required to physically surrender this Warrant to the Company unless the Holder has assigned this Warrant in full, in which case, the Holder shall surrender this Warrant to the Company within three (3) Trading Days of the date on which the Holder delivers an assignment form to the Company assigning this Warrant in full. The Warrant, if properly assigned in accordance herewith, may be exercised by a new holder for the purchase of Warrant Shares without having a new Warrant issued.

b) New Warrants. This Warrant may be divided or combined with other Warrants upon presentation hereof at the aforesaid office of the Company, together with a written notice specifying the names and denominations in which new Warrants are to be issued, signed by the Holder or its agent or attorney. Subject to compliance with Section 4(a), as to any transfer which may be involved in such division or combination, the Company shall execute and deliver a new Warrant or Warrants in exchange for the Warrant or Warrants to be divided or combined in accordance with such notice. All Warrants issued on transfers or exchanges shall be dated the Initial Exercise Date and shall be identical with this Warrant except as to the number of Warrant Shares issuable pursuant thereto.

c) Warrant Register. The Company shall register this Warrant, upon records to be maintained by the Company for that purpose (the "Warrant Register"), in the

name of the record Holder hereof from time to time. The Company may deem and treat the registered Holder of this Warrant as the absolute owner hereof for the purpose of any exercise hereof or any distribution to the Holder, and for all other purposes, absent actual notice to the contrary.

d) Transfer Restrictions. If, at the time of the surrender of this Warrant in connection with any transfer of this Warrant, the transfer of this Warrant shall not be either (i) registered pursuant to an effective registration statement under the Securities Act and under applicable state securities or blue sky laws or (ii) eligible for resale without volume or manner-of-sale restrictions or current public information requirements pursuant to Rule 144, the Company may require, as a condition of allowing such transfer, that the Holder or transferee of this Warrant, as the case may be, comply with the provisions of Section 5.7 of the Purchase Agreement.

e) Representation by the Holder. The Holder, by the acceptance hereof, represents and warrants that it is acquiring this Warrant and, upon any exercise hereof, will acquire the Warrant Shares issuable upon such exercise, for its own account and not with a view to or for distributing or reselling such Warrant Shares or any part thereof in violation of the Securities Act or any applicable state securities law, except pursuant to sales registered or exempted under the Securities Act.

Section 5. Miscellaneous.

a) No Rights as Stockholder Until Exercise; No Settlement in Cash. This Warrant does not entitle the Holder to any voting rights, dividends or other rights as a stockholder of the Company prior to the exercise hereof as set forth in Section 2(d)(i), except as expressly set forth in Section 3. Without limiting any rights of a Holder to receive Warrant Shares on a "cashless exercise" pursuant to Section 2(c) or to receive cash payments pursuant to Section 2(d)(i) and Section 2(d)(iv) herein, in no event shall the Company be required to net cash settle an exercise of this Warrant.

b) Loss, Theft, Destruction or Mutilation of Warrant. The Company covenants that upon receipt by the Company of evidence reasonably satisfactory to it of the loss, theft, destruction or mutilation of this Warrant or any stock certificate relating to the Warrant Shares, and in case of loss, theft or destruction, of indemnity or security reasonably satisfactory to it (which, in the case of the Warrant, shall not include the posting of any bond), and upon surrender and cancellation of such Warrant or stock certificate, if mutilated, the Company will make and deliver a new Warrant or stock certificate of like tenor and dated as of such cancellation, in lieu of such Warrant or stock certificate.

c) Saturdays, Sundays, Holidays, etc. If the last or appointed day for the taking of any action or the expiration of any right required or granted herein shall not be a Business Day, then such action may be taken or such right may be exercised on the next succeeding Business Day.

d) Authorized Shares.

The Company covenants that, during the period the Warrant is outstanding, it will reserve from its authorized and unissued Common Stock a sufficient number of shares to provide for the issuance of the Warrant Shares upon the exercise of any purchase rights under this Warrant. The Company further covenants that its issuance of this Warrant shall constitute full authority to its officers who are charged with the duty of issuing the necessary Warrant Shares upon the exercise of the purchase rights under this Warrant. The Company will take all such reasonable action as may be necessary to assure that such Warrant Shares may be issued as provided herein without violation of any applicable law or regulation, or of any requirements of the Trading Market upon which the Common Stock may be listed. The Company covenants that all Warrant Shares which may be issued upon the exercise of the purchase rights represented by this Warrant will, upon exercise of the purchase rights represented by this Warrant and payment for such Warrant Shares in accordance herewith, be duly authorized, validly issued, fully paid and nonassessable and free from all taxes, liens and charges created by the Company in respect of the issue thereof (other than taxes in respect of any transfer occurring contemporaneously with such issue).

Except and to the extent as waived or consented to by the Holder, the Company shall not by any action, including, without limitation, amending its certificate of incorporation or through any reorganization, transfer of assets, consolidation, merger, dissolution, issue or sale of securities or any other voluntary action, avoid or seek to avoid the observance or performance of any of the terms of this Warrant, but will at all times in good faith assist in the carrying out of all such terms and in the taking of all such actions as may be necessary or appropriate to protect the rights of Holder as set forth in this Warrant against impairment. Without limiting the generality of the foregoing, the Company will (i) not increase the par value of any Warrant Shares above the amount payable therefor upon such exercise immediately prior to such increase in par value, (ii) take all such action as may be necessary or appropriate in order that the Company may validly and legally issue fully paid and nonassessable Warrant Shares upon the exercise of this Warrant and (iii) use commercially reasonable efforts to obtain all such authorizations, exemptions or consents from any public regulatory body having jurisdiction thereof, as may be, necessary to enable the Company to perform its obligations under this Warrant.

Before taking any action which would result in an adjustment in the number of Warrant Shares for which this Warrant is exercisable or in the Exercise Price, the Company shall obtain all such authorizations or exemptions thereof, or consents thereto, as may be necessary from any public regulatory body or bodies having jurisdiction thereof.

e) Jurisdiction. All questions concerning the construction, validity, enforcement and interpretation of this Warrant shall be determined in accordance with the provisions of the Purchase Agreement.

f) Restrictions. The Holder acknowledges that the Warrant Shares acquired upon the exercise of this Warrant, if not registered, and the Holder does not utilize cashless exercise, will have restrictions upon resale imposed by state and federal securities laws.

g) Nonwaiver and Expenses. No course of dealing or any delay or failure to exercise any right hereunder on the part of Holder shall operate as a waiver of such right or otherwise prejudice the Holder's rights, powers or remedies. Without limiting any other provision of this Warrant or the Purchase Agreement, if the Company willfully and knowingly fails to comply with any provision of this Warrant, which results in any material damages to the Holder, the Company shall pay to the Holder such amounts as shall be sufficient to cover any costs and expenses including, but not limited to, reasonable attorneys' fees, including those of appellate proceedings, incurred by the Holder in collecting any amounts due pursuant hereto or in otherwise enforcing any of its rights, powers or remedies hereunder.

h) Notices. Any notice, request or other document required or permitted to be given or delivered to the Holder by the Company shall be delivered in accordance

with the notice provisions of the Purchase Agreement.

i) Limitation of Liability. No provision hereof, in the absence of any affirmative action by the Holder to exercise this Warrant to purchase Warrant Shares, and no enumeration herein of the rights or privileges of the Holder, shall give rise to any liability of the Holder for the purchase price of any Common Stock or as a stockholder of the Company, whether such liability is asserted by the Company or by creditors of the Company.

j) Remedies. The Holder, in addition to being entitled to exercise all rights granted by law, including recovery of damages, will be entitled to specific performance of its rights under this Warrant. The Company agrees that monetary damages would not be adequate compensation for any loss incurred by reason of a breach by it of the provisions of this Warrant and hereby agrees to waive and not to assert the defense in any action for specific performance that a remedy at law would be adequate.

k) Successors and Assigns. Subject to applicable securities laws, this Warrant and the rights and obligations evidenced hereby shall inure to the benefit of and be binding upon the successors and permitted assigns of the Company and the successors and permitted assigns of Holder. The provisions of this Warrant are intended to be for the benefit of any Holder from time to time of this Warrant and shall be enforceable by the Holder or holder of Warrant Shares.

l) Amendment. This Warrant may be modified or amended or the provisions hereof waived with the written consent of the Company and the Holder.

m) Severability. Wherever possible, each provision of this Warrant shall be interpreted in such manner as to be effective and valid under applicable law, but if any provision of this Warrant shall be prohibited by or invalid under applicable law, such provision shall be ineffective to the extent of such prohibition or invalidity, without invalidating the remainder of such provisions or the remaining provisions of this Warrant.

n) Headings. The headings used in this Warrant are for the convenience of reference only and shall not, for any purpose, be deemed a part of this Warrant.

(Signature Page Follows)

IN WITNESS WHEREOF, the Company has caused this Warrant to be executed by its officer thereunto duly authorized as of the date first above indicated.

CLEANTECH ACQUISITION CORP.

By: _____

Name:

Title:

NOTICE OF EXERCISE

TO: CLTH

(1) The undersigned hereby elects to purchase _____ Warrant Shares of the Company pursuant to the terms of the attached Warrant (only if exercised in full), and tenders herewith payment of the exercise price in full, together with all applicable transfer taxes, if any.

(2) Payment shall take the form of (check applicable box):

in lawful money of the United States; or

if permitted the cancellation of such number of Warrant Shares as is necessary, in accordance with the formula set forth in subsection 2(c), to exercise this Warrant with respect to the maximum number of Warrant Shares purchasable pursuant to the cashless exercise procedure set forth in subsection 2(c).

(3) Please issue said Warrant Shares in the name of the undersigned or in such other name as is specified below:

The Warrant Shares shall be delivered to the following DWAC Account Number:

(4) Accredited Investor. The undersigned is an "accredited investor" as defined in Regulation D promulgated under the Securities Act of 1933, as amended.

[SIGNATURE OF HOLDER]

Name of Investing Entity: _____

Signature of Authorized Signatory of Investing Entity: _____

Name of Authorized Signatory: _____

Title of Authorized Signatory: _____

Date: _____

ASSIGNMENT FORM

(To assign the foregoing Warrant, execute this form and supply required information. Do not use this form to purchase shares.)

FOR VALUE RECEIVED, the foregoing Warrant and all rights evidenced thereby are hereby assigned to

Name:

(Please Print)

Address:

(Please Print)

Phone Number:

Email Address:

Dated: _____, _____

Holder's Signature: _____

Holder's Address: _____



North America Europe Asia

800 Capitol St., Suite 2400
Houston, TX 77002-2925
T +1 713 651 2600
F +1 713 651 2700

Nauticus Robotics, Inc.
17146 Feathercraft Lane, Suite 450
Webster, TX 77598

Ladies and Gentlemen:

In connection with the Agreement and Plan of Merger (the "Merger Agreement"), dated as of December 16, 2021, as amended on January 30, 2022, by and among CleanTech Acquisition Corp., a Delaware corporation ("CLAQ"), CleanTech Merger Sub, Inc., a Texas corporation, ("Merger Sub") and Nauticus Robotics, Inc., a Texas corporation (the "Company"), pursuant to which Merger Sub shall merge with and into the Company, with the Company continuing as the surviving corporation (the "Merger"), we have acted as counsel to the Company in connection with the preparation and filing of the Registration Statement on Form S-4 (Registration Statement No. 333-256161), originally filed with the Securities and Exchange Commission (the "Commission") on January 31, 2022 (such Registration Statement, as amended or supplemented, is hereinafter referred to as the "Registration Statement"). Capitalized terms used herein and not otherwise defined shall have the meanings set forth in the proxy statement/prospectus which forms a part of the Registration Statement.

In providing this opinion, we have assumed (without any independent investigation or review thereof) that:

a. All original documents submitted to us (including signatures thereto) are authentic, all documents submitted to us as copies conform to the original documents, all such documents have been duly and validly executed and delivered where due execution and delivery are a prerequisite to the effectiveness thereof, and all parties to such documents had or will have, as applicable, the requisite corporate powers and authority to enter into such documents and to undertake and consummate the Merger;

b. All factual representations, warranties, and statements made or agreed to by the parties to the Merger Agreement, the Subscription Agreements, the Support Agreements, and the other agreements referred to in each of the foregoing (collectively, the "Agreements") and, together with the Registration Statement, the "Documents"), and in the representation letters provided to us by CLAQ, Merger Sub and the Company, are true, correct, and complete as of the date hereof and will remain true, correct, and complete through the consummation of the Merger, in each case, without regard to any qualification as to knowledge, belief, materiality, or otherwise;

c. The descriptions of CLAQ and the Company in the Registration Statement and other public filings are true, accurate, and complete;

d. The aggregate value of any consideration paid to dissenting stockholders with respect to their Dissenting Shares (as defined in the Merger Agreement) shall not exceed 10% of the aggregate value of the consideration paid to all stockholders of the Company in connection with the Merger;



North America Europe Asia

800 Capitol St., Suite 2400
Houston, TX 77002-2925
T +1 713 651 2600
F +1 713 651 2700

e. The description of the Merger and other transactions related to the Merger (together, the "Transactions") in the Registration Statement is and will remain true, accurate, and complete, the Transactions will be consummated in accordance with such description and with the Merger Agreement and the other Agreements, without any waiver or breach of any material provision thereof, and the Transactions will be effective under applicable corporate law as described in the Merger Agreement and the other Agreements; and

f. The Documents represent the entire understanding of the parties with respect to the Transactions, there are no other written or oral agreements regarding the Transactions other than the Agreements, and none of the material terms and conditions thereof have been or will be waived or modified.

This opinion is based on current provisions of the U.S. Internal Revenue Code of 1986, as amended (the "Code"), the U.S. Treasury Regulations promulgated thereunder, and the interpretation of the Code and such regulations by the courts and the U.S. Internal Revenue Service, in each case, as they are in effect and exist at the date of this opinion. It should be noted that statutes, regulations, judicial decisions, and administrative interpretations are subject to change at any time and, in some circumstances, with retroactive effect. Any change that is made after the date hereof in any of the foregoing bases for our opinion, or any inaccuracy in the facts or assumptions on which we have relied in issuing our opinion, could adversely affect our conclusion. We assume no responsibility to inform you of any such change or inaccuracy that may occur or come to our attention or to supplement or revise our opinion to reflect any legal developments or factual matters arising subsequent to the date hereof. No opinion is expressed as to any transactions in connection with the Merger or any matter, other than those specifically covered by this opinion. In particular, this opinion is limited solely to matters in the Registration Statement's discussion of the Merger, and does not address the U.S. federal income tax treatment of any other items described in the Registration Statement.

The U.S. federal income tax consequences of the Merger described in the Registration Statement are complex and are subject to varying interpretations. The conclusions reached in our opinion are based on our best judgment regarding application of the relevant legal authorities. Our opinion is not binding on the U.S. Internal Revenue Service or any court, and there can be no assurance or guarantee that either will agree with our conclusions. Indeed, the U.S. Internal Revenue Service may challenge one or more of the conclusions contained herein and the U.S. Internal Revenue Service may take a position that is inconsistent with the views expressed herein. There can be no assurance or guarantee that a court would, if presented with the issues addressed herein, reach the same or similar conclusions as we have reached; indeed, a court may reach a contrary conclusion on one or more issues.

Based upon and subject to the foregoing and the limitations and qualifications herein and in the Registration Statement, we are of the opinion that the Merger will constitute a "reorganization" within the meaning of Section 368(a) of the Code.

This opinion is furnished to you solely for use in connection with the Registration Statement. This opinion is based on facts and circumstances existing on the date hereof. We hereby consent to the filing of this opinion as an exhibit to the Registration Statement and also to the references to Winston & Strawn LLP in the Registration Statement. In giving such consent, we do not thereby concede that we are within the category of persons whose consent is required under Section 7 of the Securities Act or the rules and regulations of the Commission thereunder.

Very truly yours,

CERTAIN IDENTIFIED INFORMATION HAS BEEN EXCLUDED FROM THIS EXHIBIT BECAUSE IT IS BOTH NOT MATERIAL AND IS THE TYPE THAT THE REGISTRANT TREATS AS PRIVATE OR CONFIDENTIAL.



Company Confidential



Page 1 of 120

Houston Mechatronics, Inc 17146 Feathercraft Lane Suite 450 Webster, Texas TX 77598 USA	Quotation	Q210108SM01 Rev B
	Date:	18. Jan. 2021
	Contact:	Stefan Marx
	Your reference:	RFQ, 23. Oct. 2020 Aquanaut new series
	Attention to:	Sandeep Yayathi syayathi@houstonmechatronics.com

ROM Quotation

“New Aquanaut Battery”

High-performance Li-Ion battery for innovative vehicles



Example image of Li-Ion high-performance underwater vehicle battery

Summary	
Battery configuration	Series 416 Batteries, titanium housing 500m, 3000m, 6000m Optional: power distribution, 24/48V 200A converter, subsea charging
Form factor	Ø450 x 1010 mm, 267 kg in air, 103 kg in sea water (5 modules, 500m)
Energy	2x 36/64 kWh nominal, 2x 33/60 kWh available 130-185V (5/9 modules)
Voltage	162 V nominal (130 ... 185V)
Power	16 kW cont., 20 kW max. cont. - 25 kW optional, per battery
Charge	PowerCharger™ 10/15 kW (5/9 modules), approx. 4-5h charging time

SubCtech GmbH
 Wellseedamm 1-3 • D-24145 KIEL • Germany
 Managing Director: Dipl.-Phys. Stefan Marx
 Amtsgericht Kiel HRB 11552 KI
 VAT-Id.No. DE270099549

phone: +49 (0) 431-22039880
 fax: +49 (0) 431-22039881
 mobile: +49 (0) 178-35 21 99 2
 email: info@subctech.com
 web: www.subctech.com

Bank: Foerde Sparkasse
 IBAN DE92 2105 0170 1400 0559 58
 BIC NOLADE21KIE
 The protection notice ISO 16016 applies to the content of this document.

Dear Sir or Madam,

Thank you very much for your interest in our innovative subsea Li-Ion PowerPacks™. Please find enclosed our quotation for a safe, robust, high-performance and high-reliably Subsea PowerPack™. This system is designed for your specific application according your requirements.

Our batteries are approved from many companies and Navies and the Oil+Gas Offshore industry and used for critical applications. With UL and UN certified cells, our IPC-A-600/610 class 3 production following MIL-STD or ISO 13628-6, API 17F, and our long experience, we provide highest capacity, reliability and safety for our customers.

Our approach orientates on the needs of the customer. We provide communication, flexibility and lasting developments. Our power is the realisation of professional solutions for challenging tasks. Our philosophy is making things easy, providing ready-to-go solutions with our flexible engineering and scientific team.

We hope you find this offer very interesting and meet your requirements. We are looking forward to your feedback.

Team SubCtech

Guide:

- Your customized solution and specification: chapter 5
- Your quotation: chapter 6
- Your terms and lead times: chapter 7

SubCtech GmbH
Wellseedamm 1-3 • D-24145 KIEL • Germany
Managing Director: Dipl.-Phys. Stefan Marx
Amtsgericht Kiel HRB 11552 KI
VAT-Id.No. DE270099549

phone: +49 (0) 431-22039880
fax: +49 (0) 431-22039881
mobile: +49 (0) 178-35 21 99 2
email: info@subctech.com
web : www.subctech.com

Bank: Foerde Sparkasse
IBAN: DE92 2105 0170 1400 0559 58
BIC: NOLADE21KIE
The protection notice ISO 16016 applies
to the content of this document.

[REDACTED]

[REDACTED]

[REDACTED]

[REDACTED]

[REDACTED]

[REDACTED]

[REDACTED]

[REDACTED]

[REDACTED]

[REDACTED]

[REDACTED]

[REDACTED]

[REDACTED]

[REDACTED]

[REDACTED]

[REDACTED]

[REDACTED]

[REDACTED]

[REDACTED]

1.3 Confidentiality Statement

This document contains confidential and proprietary information to SubCtech GmbH. This document and all the information contained herein are the confidential and exclusive property of SubCtech GmbH, and may not be reproduced, disclosed, or made public to any other 3rd party without written authorization by SubCtech GmbH and any of its subsidiaries.

1.4 Copyright

© SubCtech GmbH. All rights reserved. All pictures and trademarks mentioned in this user manual are property of their respective owners. All texts, images, graphics, sounds, animations and videos, as well as their arrangement within the layout of SubCtech documents are subject to national and international copyright laws and other applicable legislation.

NetDI, SmartDI, MicroDI, PowerPack, SmartPowerBlock, SmartCharger, PowerCharger, SmartBMS, SmartPCB, OceanLine, OceanPack, OceanPack RACE, OceanPack MOBILE, OceanPack RACK, mBubbler, Gosubsea, Subsea-Power and SubCtech are registered or applied trademarks of SubCtech GmbH, Germany. All other trademarks belong to their respective owners.

Any used logos are usually protected by the manufacturers. Any used picture or any material is partly protected and may not be photocopied, reproduced, or translated to another language without prior written consent of SubCtech.

There is no responsibility for the content of used websites or URL links.

If you find any licensed photos, text or other material, or do not approve of the publication of material, please inform us. Please give details on name, copyright holder or what else could be important to us. The material will thereupon be removed by us.

1.5 Liability

This proposal has been developed with the highest due diligence. Nevertheless, we cannot provide any warranty whatsoever for absence of errors and accuracy of the given information. We disclaim any liability for damage that might, directly or indirectly, result of using this web site, as long as they have not been caused intentionally or through gross negligence.

Please note: in view of our continual improvement policy, the design and specifications of our products may vary from those illustrated in this proposal.

SubCtech GmbH
Wellseedamm 1-3 • D-24145 KIEL • Germany
Managing Director: Dipl.-Phys. Stefan Marx
Amtsgericht Kiel HRB 11552 KI
VAT-Id.No. DE270099549

phone: +49 (0) 431-22039880
fax: +49 (0) 431-22039881
mobile: +49 (0) 178-35 21 99 2
email: info@subctech.com
web : www.subctech.com

Bank: Foerde Sparkasse
IBAN: DE92 2105 0170 1400 0559 58
BIC: NOLADE21KIE
The protection notice ISO 16016 applies
to the content of this document.

3 History SubCtech

SubCtech's ("Subsea Technologies for the Marine Environment") team already has more than 29 years of experience in the subsea and marine technology. Today 2020, with 35 employees, the company is still privately owned.

We offer underwater technologies, subsea solutions and ocean monitoring systems. We find solutions in close collaboration with our clients – in the industry, in science and offshore Oil+Gas. Li-Ion batteries, e.g. pCO₂ analyzers and system solutions are our core products and one-stop service. Our reliable and precise high-tech "Made in Germany" products are easy to handle and efficiency to our customers. The mixture of experienced employees, young scientists and market knowledge is so successful that the company has been profit-making from the first year on.

We are certified by ISO 9001:2015 and manufacturing according to ISO 13628-6 and API17F for design and operation of subsea production systems. Our qualified workshop and engineers are educated and certified for highest-quality IPC-A-600/610 class 3 production for SIL rating.

- **Our goal:** meeting customers' requirements – communicating well – working flexible – developing products constantly
- **Our promise:** Solving complex and challenging tasks – delivering professional solutions
- **Our products:** high reliable – highest quality - high performance - easy to maintain – resistant – comfortable to handle

Mission



Our approach follows the needs of the customer. We provide communication, flexibility and lasting developments. Our strength is the realization of professional solutions for challenging tasks. The robustness was proven during diverse usages in industry, administration and science.



"Our innovations: tradition is a valuable asset but no limit"

SubCtech GmbH
Wellseedamm 1-3 • D-24145 KIEL • Germany
Managing Director: Dipl.-Phys. Stefan Marx
Amtsgericht Kiel HRB 11552 KI
VAT-Id.No. DE270099549

phone: +49 (0) 431-22039880
fax: +49 (0) 431-22039881
mobile: +49 (0) 178-35 21 99 2
email: info@subctech.com
web: www.subctech.com

Bank: Foerde Sparkasse
IBAN: DE92 2105 0170 1400 0559 58
BIC: NOLADE21KIE
The protection notice ISO 16016 applies to the content of this document.

3.1 Company Facilities and Location

SubCtech GmbH is located at the Industrial Business Centre of Wellsee, Kiel, between Baltic and North Sea.

We work together with the Universities of Kiel, Flensburg, Lübeck and Hamurg. GEOMAR and Max-Planck Hamburg and Fraunhofer Rostock are also partners in the neighborhood. The good connection to ports and airports and the route to Scandinavia should be emphasized.

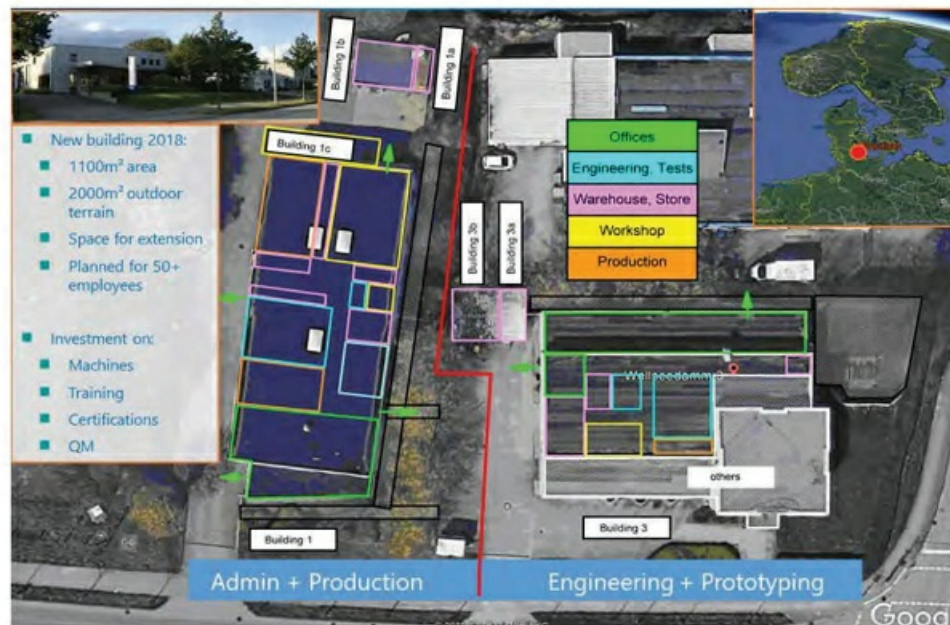


Image 1: Our headquarter with production in Kiel between North Sea and Baltic Sea.

- 2 separate buildings for engineering / prototyping and production / admin
- 1200 m² of space, 2000m² outdoor terrain, space for extension building
- 3 workshops (2 x CNC workshops, 1 x prototype workshop)
- Warehouse with automated entry and access control
- 2 electrical productions (EPA IPC class 3, EPA prototyping) with access control
- 1 spray booth for formal coatings
- 1 high-voltage laboratory (especially subsea + vehicle batteries)
- 1 test hall for large batteries with 2t hoist, 50kW charging, 70kW discharging
- 2 control units development systems (ARM KEIL prof. incl. safety extension)
- 2 test-labs for water systems (salt water, temperature controlled)

SubCtech GmbH
Wellseedamm 1-3 • D-24145 KIEL • Germany
Managing Director: Dipl.-Phys. Stefan Marx
Amtsgericht Kiel HRB 11552 KI
VAT-Id.No. DE270099549

phone: +49 (0) 431-22039880
fax: +49 (0) 431-22039881
mobile: +49 (0) 178-35 21 99 2
email: info@subctech.com
web: www.subctech.com

Bank: Foerde Sparkasse
IBAN: DE92 2105 0170 1400 0559 58
BIC: NOLADE21KIE
The protection notice ISO 16016 applies to the content of this document.

- 1 climate test chamber
- 1 battery cell impedance test-lab
- 6 ECAD design stations (Eagle prof.)
- 2 CAD design stations (SolidWorks prof.)

We provide professional development and production services. Our customer is our partner and our customer's satisfaction has priority. We are proud to provide fully professional service through all phases from pre-consulting to after-sales.



Image 2: Example of our facilities and API17F qualification with accredited laboratories and institutes

Our special skills are arctic conditions, deep-sea applications, long-term deployments and design life, high quality standardized production and realizing customers' requirements.

In addition, SubCtech supports environmental and marine science and technical projects as well as students and young scientists.



Image 3: Our development and production are driven by qualified innovative processes.

We take our social, economic and environmental responsibility seriously. We act future-orientated in regards of environmental and social issues. We support social facilities, especially for kids as we are convinced that "Kids are our future". We provide opportunities for young people, students and researchers to get insight in working life and subsea technology.

SubCtech supports organizations and projects with direct financial aid:

[Sponsorship - SubCtech - Ocean Power & Monitoring](#)

SubCtech GmbH
Wellseedamm 1-3 • D-24145 KIEL • Germany
Managing Director: Dipl.-Phys. Stefan Marx
Amtsgericht Kiel HRB 11552 KI
VAT-Id.No. DE270099549

phone: +49 (0) 431-22039880
fax: +49 (0) 431-22039881
mobile: +49 (0) 178-35 21 99 2
email: info@subctech.com
web: www.subctech.com

Bank: Foerde Sparkasse
IBAN: DE92 2105 0170 1400 0559 58
BIC: NOLADE21KIE
The protection notice ISO 16016 applies to the content of this document.

3.2 Road Map

Corporate Strategy SubCtech GmbH:

- Major supplier for Subsea batteries and FerryBox scientific vessel systems
- Top technologies, highest quality standards and highest innovations
- Committed team
- Environmental sustainability
- Global responsibility

Strong business development

- Long track record since 2006
- Sustainable steady growth
- Valued customer with increasing projects
- Stable financing, 100% private, growth even in the COVID-19 crisis



Image 4: Our Road Map for OCEAN POWER batteries (Dec. 2020)

SubCtech GmbH
 Wellseedamm 1-3 • D-24145 KIEL • Germany
 Managing Director: Dipl.-Phys. Stefan Marx
 Amtsgericht Kiel HRB 11552 KI
 VAT-Id.No. DE270099549

phone: +49 (0) 431-22039880
 fax: +49 (0) 431-22039881
 mobile: +49 (0) 178-35 21 99 2
 email: info@subctech.com
 web: www.subctech.com

Bank: Foerde Sparkasse
 IBAN: DE92 2105 0170 1400 0559 58
 BIC: NOLADE21KIE
 The protection notice ISO 16016 applies to the content of this document.

4 Common technical data

For a better overview, we have put the general specifications in front.

The specific data can be found at the end of this proposal, together with the technical specifications, the offer and T&C.

4.1 General Overview

The battery (including the battery management system) is one of the most important parts of an electrical subsea system. The battery is necessary to provide electrical power to operate e.g. the tree gate valves as specified. This is normally required, as the typ. DC/FO system does not deliver an adequate amount of power to operate the system without any energy storage.

This special designed subsea PowerPack™ is suitable to operate under rough offshore subsea conditions and long lifetime up to 25 years. To provide power, the design was optimized for highest power and performance, highest safety and highest reliability. This PowerPack™ is designed to fulfil all requirements inside the given specification.

Our batteries have low capacity loss over time as well as high usable energy over a wide state of charge (SOC) range, allowing our systems to meet end-of-life power and energy requirements with minimal pack oversizing. This type of battery and BMS with charger was already successfully used in a number of subsea & vehicle applications.

This type of battery and BMS with charger was already successfully used in a number of subsea applications such as AUV, ROV and other applications. The battery modules are already type approved by MIL-STD 810G and ISO 13628-6 / API17F for TRL 6 level operation in oil fields (production) and to power AUV and other vehicles.

The battery pack construction in this project is a customized COTS on a high TRL level, former developed for a manned submarine and subsea systems; and therefore on highest safety and reliability level. This larger design is actual used for all our larger projects.

The high power demand requires adjusted components and if required, a new API17F. Ordering the API17F qualification, the battery offers TRL 4.

SubCtech GmbH
Wellseedamm 1-3 • D-24145 KIEL • Germany
Managing Director: Dipl.-Phys. Stefan Marx
Amtsgericht Kiel HRB 11552 KI
VAT-Id.No. DE270099549

phone: +49 (0) 431-22039880
fax: +49 (0) 431-22039881
mobile: +49 (0) 178-35 21 99 2
email: info@subctech.com
web : www.subctech.com

Bank: Foerde Sparkasse
IBAN: DE92 2105 0170 1400 0559 58
BIC: NOLADE21KIE
The protection notice ISO 16016 applies
to the content of this document.



Image 5: Example of series 416 batteries with different features and output connectors



Image 6: Rendering of the series 416 Li-ion battery, with 10 SPBs, SMM, CIM and PDU.

SubCtech GmbH
Wellseedamm 1-3 • D-24145 KIEL • Germany
Managing Director: Dipl.-Phys. Stefan Marx
Amtsgericht Kiel HRB 11552 KI
VAT-Id.No. DE270099549

phone: +49 (0) 431-22039880
fax: +49 (0) 431-22039881
mobile: +49 (0) 178-35 21 99 2
email: info@subctech.com
web: www.subctech.com

Bank: Foerde Sparkasse
IBAN: DE92 2105 0170 1400 0559 58
BIC: NOLADE21KIE
The protection notice ISO 16016 applies
to the content of this document.

SubCtech's battery common technology features:

(The project-specific advantages are shown in the corresponding chapter)

- The battery technology consists of the latest safe and reliable high-performance Li-Ion cells
- Never open the battery, life-time unlimited.
- Charge while operating (UPS function). No need to remove the batteries.
- Charge under BMS control with extra safety monitoring
- Service free. No degassing.
- High currents without overheating or hot-spots
- High capacity (energy), much less batteries compared to other battery technologies.
- Simple RS-485 ASCII NMEA-0183 or MODBUS RTU or CAN data interface to monitor the battery online.
- High redundancy: high number of parallel connected cells, or modules, or batteries. Batteries can be connected in parallel to take over the full load, if all others fail. The Customer Interface Module (CIM) controls load+charge balancing, and manages and simplifies all data handling.
- Best performance due to optimized internal load balancing and power dissipation / heat management on battery module and cell level.
- All battery modules are identical, components are standardized. Therefore, service and operation are simplified and robust. Sustainable supply is ensured (obsolescence management)
- The internal modules, so called SmartPowerBlocks™ (SPB), provide a number of advantages to separate energy and control only parts of the battery.
- Highest system safety due to multiple safety levels, according to latest recommendations and knowledge in discussion with DNV-GL
- BMS monitoring of all major parameters such as under-discharge voltage, over-charge voltage, over-current, short-circuit, over-temperature with hot-spot detection to inform the control system with warnings and error flags about SOH or possible failures in advance.
- High reliability and safety according to functional safety IEC 61508. SIL can be optionally achieved according to IEC 61508. SIL 2 is the target of actual JIP R&D projects.
- To provide robustness and high-reliability for operation or optional qualifications according to e.g. MIL-STD 810G, DNV GL, ISO 13628-6 or API17f
- Transport regulations can be fulfilled with optional UN T38.3 certification (recommended)
- Low OPEX with long design life of up to 25 years for the offshore Oil+Gas industry, and service life of typically > 10 years, mostly expected > 15 years.

SubCtech GmbH
Wellseedamm 1-3 • D-24145 KIEL • Germany
Managing Director: Dipl.-Phys. Stefan Marx
Amtsgericht Kiel HRB 11552 KI
VAT-Id.No. DE270099549

phone: +49 (0) 431-22039880
fax: +49 (0) 431-22039881
mobile: +49 (0) 178-35 21 99 2
email: info@subctech.com
web: www.subctech.com

Bank: Foerde Sparkasse
IBAN: DE92 2105 0170 1400 0559 58
BIC: NOLADE21KIE
The protection notice ISO 16016 applies to the content of this document.

4.2 SubCtech's standard safety levels

4.2.1 Our Philosophy

The stable quality of our products and services is one of the foundations of our successful business activity. For us, quality means meeting the demands of our customers in the best possible way. In this sense, quality is an important criterion for the purchase decision and forms a reliable bond with our customers.

For us, acting quality-consciously also means using valuable resources efficiently and carefully. Every employee has the duty and the right to work to ensure that circumstances that prevent the manufacture of products of perfect quality are eliminated.

The continuous improvement of quality is therefore also a prerequisite for us in the medium and long term for an effective reduction in costs and an important contribution to protecting the environment.

Trouble-free organization and the most advanced methods of quality management provide the necessary framework. Our understanding of quality and quality awareness, as well as the correct attitude of all employees to quality are prerequisites for the satisfaction of our customers and thus for the long-term success of our company.

4.2.2 HSE as a holistic concept

The HSE (health, safety and environment) principles constitute action maxims for SubCtech. In economic decision making as well as in our daily working routine the topics of environmental protection, health care, work, process and product safety are of great importance at SubCtech. In order to be successful, we at SubCtech work as a unit - from the management to the intern.

Our HSE guideline provides a supporting framework for our employees in order to realize and achieve our HSE goals within the company. Hence, we are able to constantly improve all processes and use resources more efficiently. Regularly responsible specialist departments review the achievement of our HSE goals as well as evaluating new risks and identifying further potential improvements. Furthermore, they ensure the section's legal conformity.

The early detection of potential dangers when handling our products is important to us. This is the only way to examine, analyze and evaluate identified risks and to initiate appropriate countermeasures.

- The HSE principles constitute action maxims for SubCtech. Additionally, SubCtech commits to the compliance of high standards in the fields of work and product safety, health care and environmental protection.



SubCtech GmbH
Wellseedamm 1-3 • D-24145 KIEL • Germany
Managing Director: Dipl.-Phys. Stefan Marx
Amtsgericht Kiel HRB 11552 KI
VAT-Id.No. DE270099549

phone: +49 (0) 431-22039880
fax: +49 (0) 431-22039881
mobile: +49 (0) 178-35 21 99 2
email: info@subctech.com
web: www.subctech.com

Bank: Foerde Sparkasse
IBAN: DE92 2105 0170 1400 0559 58
BIC: NOLADE21KIE
The protection notice ISO 16016 applies to the content of this document.

4.2.3 Features

QMS overview

- ISO 9001 in 2015, re-audit ISO 9001:2015 in 2018 (Reg.SEC-DE270099549-01/15)
- O+G audited since 2013, various companies (CAMERON/OneSubsea, ABB, ...)
- ESD protection program since 2010
- IPC class 3, IPC-J-SDT quality program since 2013
- Supply chain management with supplier evaluations
- Traceability of material
- Obsolescent management
- HSE Environmental protection program reduces CO2 footprint by 30%
- Health protection program for all employees

Qualification

- ISO 9001 since 2015 (Reg. SEC-DE270099549-01/15)
- UBA approval as battery manufacturer according to BattG (Reg. 21002655)
- LBA approval for Air-Cargo (Reg.B32F/439.234-1/2018)
- NATO and US supplier registration (NCAGE CN2N5, DUNS® 341552832)
- US D.O.T. import permit for air cargo / hazardous substances (DOT-SP 20232)
- Approval for handling of dangerous goods road, sea, air according to ADR, DGM, IATA etc.
- API17F qualifications since 2014
- MIL-STD and DNV-GL qualifications since 2014
- IEC 61508 since 2016, target SIL for 2022

Implementation

- Industrial Li-Ion cells with stainless steel housing (higher melt temperature compared to commercial cells with e.g. aluminum cans). The enclosure is welded, not simple shrunk.
- Industrial Li-Ion cells with triple internal protection: over pressure valve, current interrupt device CID, temperature isolating layer (positive temperature coefficient device PTC)
- Industrial Li-Ion cells with UL listing and UN T38.3 certification
- Separation of the energy into smaller sub-modules and lower energy, installed into extreme robust non-flammable but light-weight foam (complies to FAR 25.853 / ABD 0031).
- Independent protection of each module (SmartPowerBlock™) with its own BMS supervision (low voltage – under discharge, high voltage – over charge, under temperature particular for charge, over temperature, over current, short circuit. (Not for subsea-UPS)
- Warning and error levels (configurable) for a number of conditions, incl. internal failures such as broken connectors or wires, temperature sensor failures, SOC, SOH – end of life
- Independent safety loop disconnect the battery in case of fatal failures. The safety loop is used for the battery while discharging and charging connected to the PowerCharger or embedded underwater charger.

SubCtech GmbH
Wellseedamm 1-3 • D-24145 KIEL • Germany
Managing Director: Dipl.-Phys. Stefan Marx
Amtsgericht Kiel HRB 11552 KI
VAT-Id.No. DE270099549

phone: +49 (0) 431-22039880
fax: +49 (0) 431-22039881
mobile: +49 (0) 178-35 21 99 2
email: info@subctech.com
web: www.subctech.com

Bank: Foerde Sparkasse
IBAN: DE92 2105 0170 1400 0559 58
BIC: NOLADE21KIE
The protection notice ISO 16016 applies
to the content of this document.

[Redacted]

- [Redacted]
[Redacted]
[Redacted]
[Redacted]
[Redacted]
[Redacted]
- [Redacted]
[Redacted]
[Redacted]
[Redacted]
- [Redacted]
[Redacted]
[Redacted]
[Redacted]
[Redacted]
[Redacted]
[Redacted]
[Redacted]
- [Redacted]
[Redacted]
[Redacted]
[Redacted]

[Redacted]

4.3 Safety level implementation

4.3.1 Safety level structure

The safety of the whole system is subdivided into different levels. Each of it provides prevention of dangerous system conditions and hazards. Critical voltage levels and therefore irreversible damage to the batteries are supervised and prevented by software in higher safety levels and even checked and prohibited by hardware on the lowest safety level, the battery cell level.

Summary

Safety (cell level)	PTC element against overheating stainless steel can for robustness CID element against over current gas exhaust hole against over pressure small form factor for small energy units per cell
Safety (Module level)	Over charge (over-voltage) under voltage discharge over current limiting & short circuit over temperature discharge with hot-spot detection by the BMS master under temperature charging. Optional melting fuse for fatal overload current (slow current detection) Optional leakage detection. Independent safety loop disconnects the battery or charging unit if one component fatal fails.
Safety (BMS Master level)	Optional manual all-pole circuit breaker or melting fuse for fatal overload current (slow current detection) or short circuit Independent safety loop disconnects the battery or charging unit if one component fatal fails (<i>not used for UPS systems</i>). Continuously monitoring of all voltages (over voltage, under voltage, differences between cells), current, temperatures (hot spot detection and differences between cells)
Safety (Battery converter level)	Current limiting with short circuit protection Thermal shutdown with automatic recovery in case of insufficient cooling. Ruggedizing, conformal coating Continuously monitoring of voltages, current, temperatures.

[Redacted]

[Redacted]

[Redacted]

[Redacted]

[Redacted]

[Redacted]

[Large Redacted Block]

[Redacted]

[Redacted]

[Redacted]

[Redacted]	[Redacted]	[Redacted]
[Redacted]	[Redacted]	[Redacted]
[Redacted]	[Redacted]	[Redacted]
[Redacted]	[Redacted]	[Redacted]

[Redacted text block containing multiple paragraphs of blacked-out content]

[Redacted text block]

[Large redacted text block]

[Redacted text block]

[Redacted text block]

[Redacted text block]

[Redacted text block]

4.4 Implementation

- **Functional safety (optionally)**

The project is performed under functional safety aspects (IEC 61508) and external audit to achieve optimal SIL level. For SubCtech, calculating the SIL suitability level is a combined effort between corporate quality, engineering, and a 3rd party for validating calculations. The steps include failure rate prediction, FMEDA, Failure Path Investigation, and a 3rd party validation. SubCtech's safety engineers are trained and certified by TÜV. For SIL, we are cooperating with the TÜV.

- **Workmanship**

The production is performed according e.g. IPC-A-600/610 class 2 or 3, and J-STD-001 and other to meet highest quality standards. SubCtech's high-tech production engineers are trained and certified by FED (IPC, J-STD). SubCtech is regularly audited by an important customer.

- **Quality management**

SubCtech is working and certified according the latest ISO 9001 and work according to ISO 140001. Our trained and certified quality engineer, in close cooperation with the management and employees, takes care about the implementation of all QM and HSE processes. Our major industry customers monitor us with regular audits.

- **Operation and transport**

SubCtech is certified by German UBA for battery production, sales and disposal.

SubCtech is approved by German LBA and US D.O.T for air cargo for our battery products. Our trained and certified quality engineers are approved for handling, packing and creating of any shipper's declaration such as IMO for air (IATA), sea (DGR, ADR) and street (ADR) transport.

		
<p>Image 10: SubCtech certificate for ISO-9001:2015</p>	<p>Image 11: Example of SubCtech's personal training for IPC J-STD and IPC-A-600/610 class 3 production</p>	<p>Image 12: Example of SubCtech's personal training for IEC 61508 / SIL products by TÜV SÜD</p>

4.5 How it looks: examples of batteries



Image 13: Example of Subsea Control Unit (CIM: Customer interface Module) to connect up to 12 large high-power batteries in parallel



Image 14: Example of AUV battery in 6000m housing during FAT



Image 15: Example of 310mm AUV battery during installation (41kWh)



Image 16: Example of customized battery system with Power Distribution Unit 500V 10kW each channel + DC/DC



Image 17: Example of 310mm AUV battery with 6 SPB modules during installation



Image 18: Series 416 Li-Ion battery 430V 70kWh for 55kW manned vehicles

4.6 Battery Technical Design

The modules are constructed according to our already approved technology. The non-flammable foam is extreme robust and lightweight (air+space certification). Therefore, the environmental conditions such as shock and vibration can be fulfilled also for large assemblies.

The construction and design is validated first with FEM tools to guarantee over-all robustness and proper power balancing inside the modules.

The UPS unit can be equipped with an insulation monitoring device. The data is transmitted as warning flags in the data protocol.

For the cells industrial Li-Ion cells are used. With a relative small capacity compared to latest cells e.g. developed for e-cars, safety, lifetime and reliability are high.

Using small 18650 cells with < 12Wh energy compared with large Li-on cells or Li-Pol cells (e.g. pouch cell) with > 150Wh, the energy per cell is low and safe. The internal protection of the cells is well developed and tested to use e.g. for Air+Space applications.

On the other hand, a larger number of cells connected in parallel, gives a much higher reliability and safety compared to designs with few large cells. The possible failure of one or more cells is not critical.

The cells are embedded in lightweight but stiff construction foam which ensures that the cells are kept in place with a minimal cell distance. This ventilation opportunity prevents any hot spots between the cells (which even would be expected at a discharge rate of e.g. 0,5C). Its fire resistance was tested and the foam fulfils many industrial standards.

During charge and discharge, the major priority is reliability and performance. Due to the high-parallel connection of cells, the load on each is small, and heating or aging is not an issue.

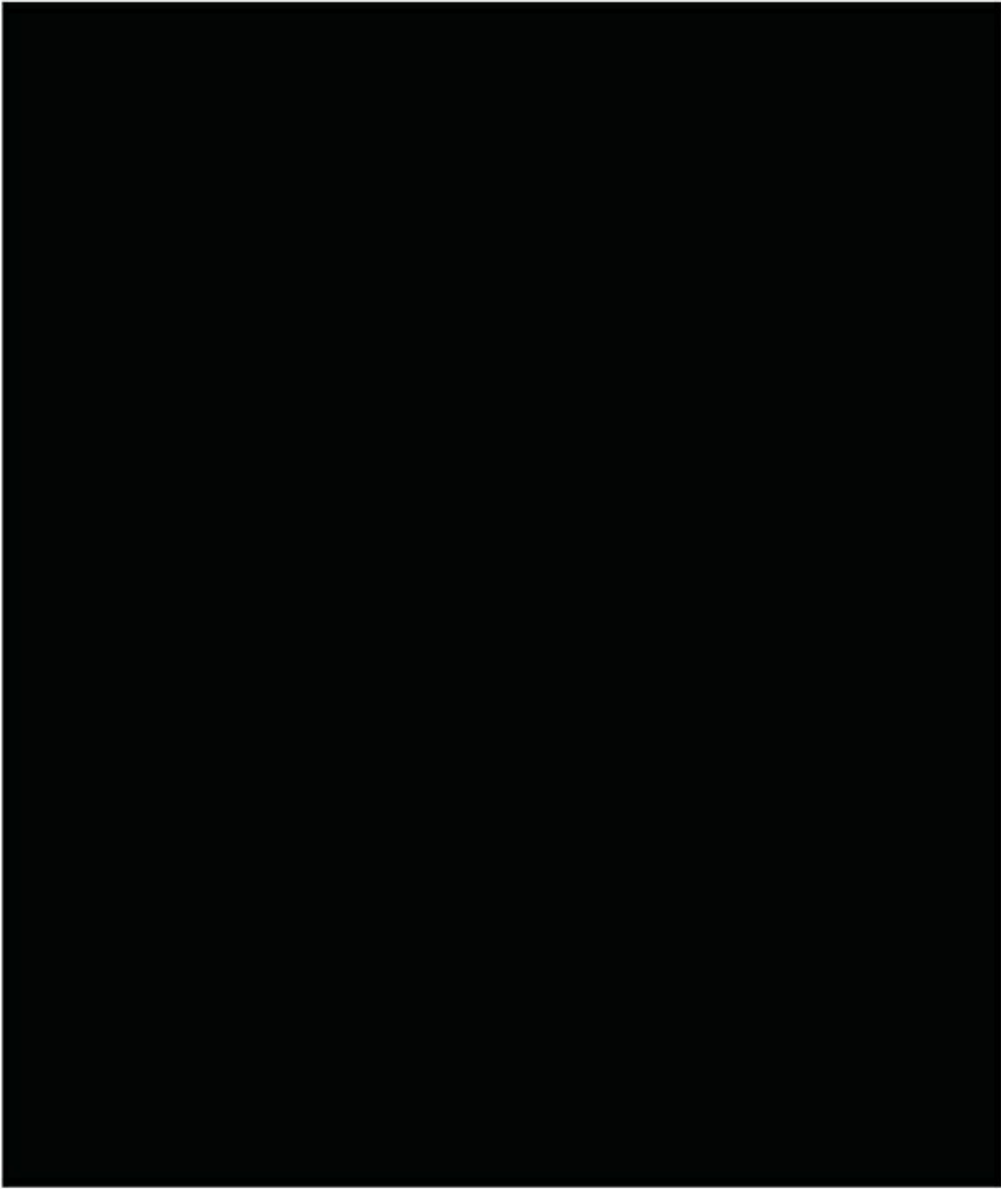


Image 19: Example of 310mm flexible SmartPowerBlock™ concept with Slave-BMS controller and protection on top. Automatic voltage-free after removal.

SubCtech GmbH
Wellseedamm 1-3 • D-24145 KIEL • Germany
Managing Director: Dipl.-Phys. Stefan Marx
Amtsgericht Kiel HRB 11552 KI
VAT-Id.No. DE270099549

phone: +49 (0) 431-22039880
fax: +49 (0) 431-22039881
mobile: +49 (0) 178-35 21 99 2
email: info@subctech.com
web: www.subctech.com

Bank: Foerde Sparkasse
IBAN: DE92 2105 0170 1400 0559 58
BIC: NOLADE21KIE
The protection notice ISO 16016 applies to the content of this document.



[Redacted text]

[Redacted]

[Redacted]

[Redacted]

[Redacted]

[Redacted]

[Redacted]

[Redacted]

[Redacted]

[Redacted]

- [Redacted]
- [Redacted]
- [Redacted]
- [Redacted]
- [Redacted]

[Redacted]	[Redacted]	[Redacted]	[Redacted]
[Redacted]	[Redacted]	[Redacted]	[Redacted]
[Redacted]	[Redacted]	[Redacted]	[Redacted]
[Redacted]	[Redacted]	[Redacted]	[Redacted]

[Redacted]

[Redacted]

[Redacted]

[Redacted]

[Redacted]

[Redacted]

[Redacted]

[Redacted]

Bank: [Redacted]

[Redacted]

[Redacted]

[Redacted]

[Redacted]

[Redacted]

[Redacted]

[Redacted]

[Redacted]

[Redacted]

[Redacted]

4.7 Power Distribution Unit (PDU)

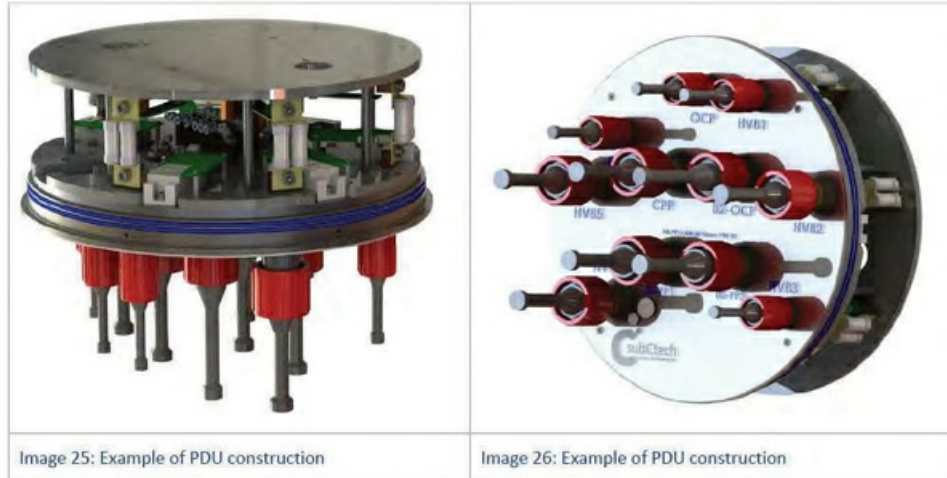


Image 25: Example of PDU construction

Image 26: Example of PDU construction

4.8 Customer interface Controller (CIM)

This CIM controller collect the data of all batteries and summarize the data for the vehicle and pilot. Summarized data includes: all common data such as SOC or SOH, but summarizes a set of values for each battery module. This simplifies the integration and control. Summarized data includes: all common data such as SOC or SOH, but summarizes a set of values for each battery module. This simplifies the integration and control.



Image 27: Example of CIM module

SubCtech GmbH
Wellseedamm 1-3 • D-24145 KIEL • Germany
Managing Director: Dipl.-Phys. Stefan Marx
Amtsgericht Kiel HRB 11552 KI
VAT-Id.No. DE270099549

phone: +49 (0) 431-22039880
fax: +49 (0) 431-22039881
mobile: +49 (0) 178-35 21 99 2
email: info@subctech.com
web : www.subctech.com

Bank: Foerde Sparkasse
IBAN: DE92 2105 0170 1400 0559 58
BIC: NOLADE21KIE
The protection notice ISO 16016 applies to the content of this document.

[Redacted text block]

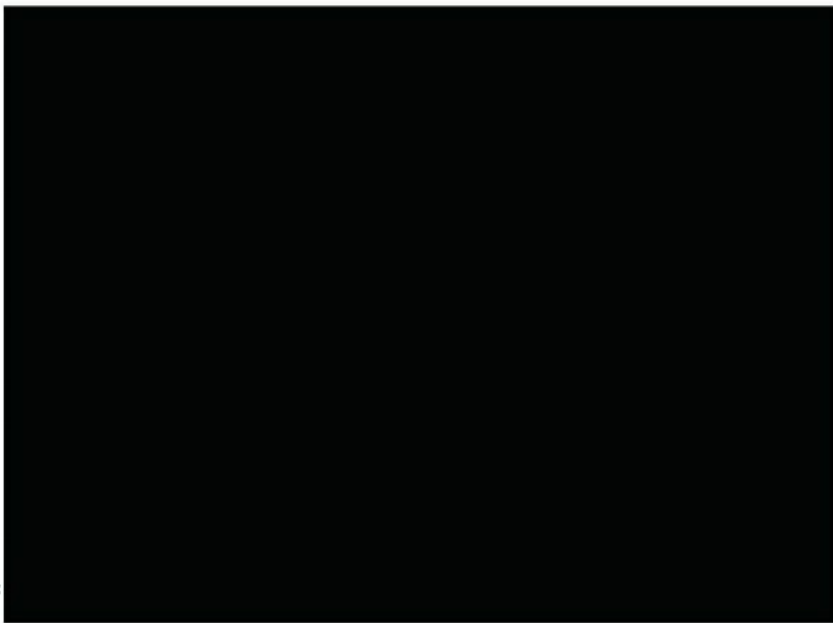


Image 28:

[Redacted text block]

lies

4.10 Data interface and storage

Our data protocol incorporates all needed and required parameters, and additional warning and error states to inform the pilot in advance about any special situation. The values are internally validated, and warning or error levels are suitable for safe and reliable operation. E.g., if a single house-keeping sensor such as a temperature sensor fails, the number and clustering of failures will be processed first.

The existing data system may be used and adapted. We provide our own standard data protocol with MODBUS RTU, or simple ASCII NMEA-0183 data protocols (SubCtech is a member of the NMEA). Both are developed for high-reliability vehicle battery communication. The NMEA and MODBUS data protocols are using checksums, interface watchdogs and are expandable for future upgrade paths.

CAN and others are available with our CIM module. Others such as CAN Safety or Ethernet / Profinet on request.

Storage	Internal storage of log data, up to 32 GB of flash memory (years of data depending on the sample rate) Download by remote via MODBUS and CIM to the charger USB connector
BMS Interface	MODBUS RTU Modicon PI-MBUS-300, RS-485, galvanic isolated Individual addressing of all sub-systems (batteries, PDU, converter if any) Option: ASCII NMEA-0183 data strings, RS-232 or RS-485, galvanic isolated, CAN, CANopen (CIA 443 under work), Ethernet TCP/IP
BMS control and measure Parameter	All single cell level voltages, Battery voltage, Charge and discharge current, optional every PDU output channel Battery temperatures (hot spot detection in every SPB module), Charger temperature, Diagnostic and status flags (warning and error levels), Runtime, State of charge SOC, State of Health SOH. Internal parameters: firmware version, serial number more: TBD - e.g. leak detection or OEM signals For details see data interface manual

Note:

possible overrides of specific BMS shutdown or other parameters. MODBUS registers can be set individually for changed requirements, even later during operation. These are password protected against accidental overwriting. A complete XML configuration file can also be uploaded to the individual BMS controllers.

This makes it possible, for example, to set limits for SOC, undervoltage, overcurrent, etc. when installed. This means that adaptations for new requirements or changes can be carried out easily. Uploading to 100% SOC, if this has been reduced, is also simple possible via software configuration.

[Redacted text block]

[Redacted text block]

[Redacted text block]

[Redacted text block]

4.10.4 ASCII NMEA-0183

The data protocol is simple ASCII according NMEA-0183 (compared to GPS receiver).

SubCtech becomes a member of the NMEA (National Marine Electronics Association) and provides standard NMEA data protocols. The NMEA is committed to promoting and developing the market for maritime electronics. It is an association of manufacturers, resellers, educational institutes and other people with interest in this market (Source: "NMEA News").



Read see the NMEA manual for details.

Please note: from 2020 on, the ASCII NMEA-0183 data protocol is provided only on request. Standard is MODBUS RTU or CAN using the CIM controller.

SubCtech GmbH
Wellseedamm 1-3 • D-24145 KIEL • Germany
Managing Director: Dipl.-Phys. Stefan Marx
Amtsgericht Kiel
VAT-Id.No. DE270099549

phone: +49 (0) 431-22039880
fax: +49 (0) 431-22039881
mobile: +49 (0) 178-35 21 99 2
email: info@subctech.com
web: www.subctech.com

Bank: Foerde Sparkasse
IBAN: DE92 2105 0170 1400 0559 58
BIC: NOLADE21KIE
The protection notice ISO 16016 applies
to the content of this document.

[Redacted]

[Redacted]

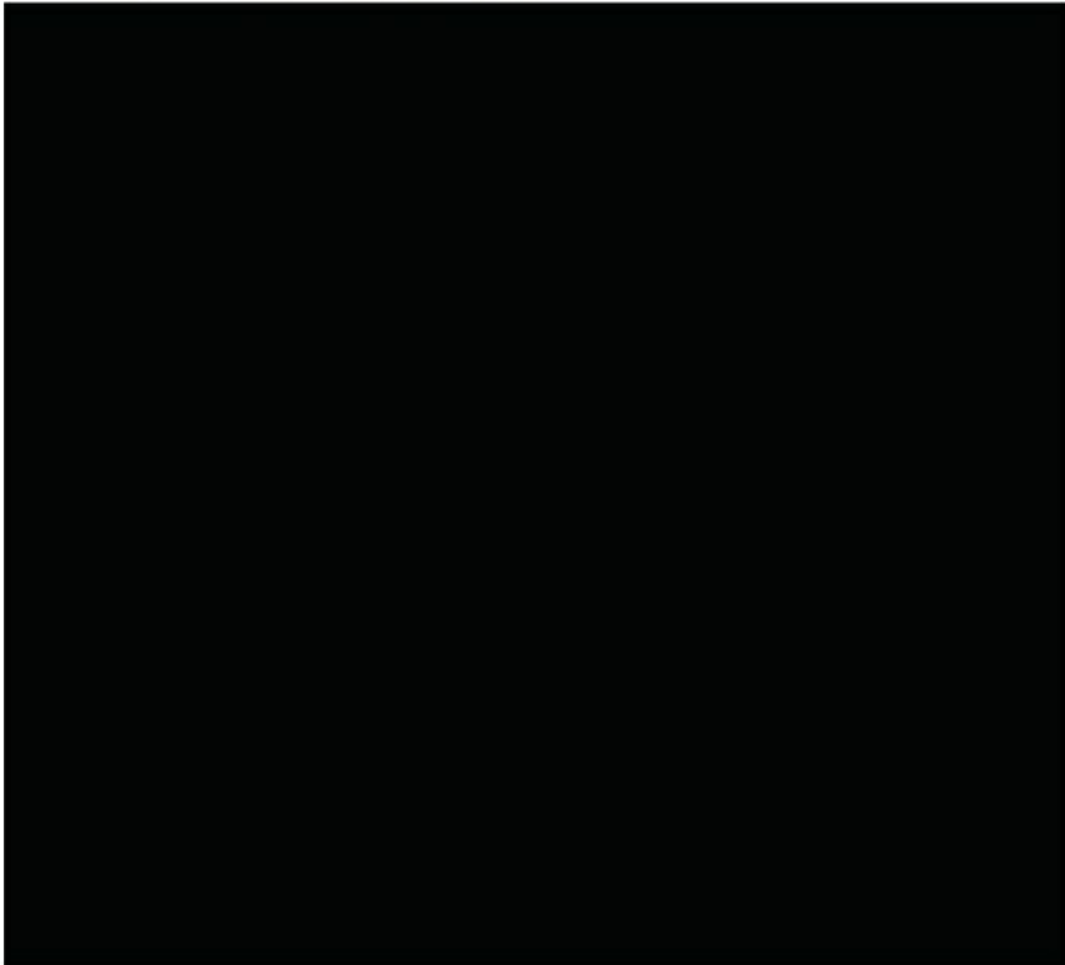
[Redacted]

[Redacted]

[Redacted]

[Redacted]

[Redacted]



[REDACTED]

[Redacted]

[Redacted]

[Redacted]

- [Redacted]
- [Redacted]

[Redacted]

[Redacted]

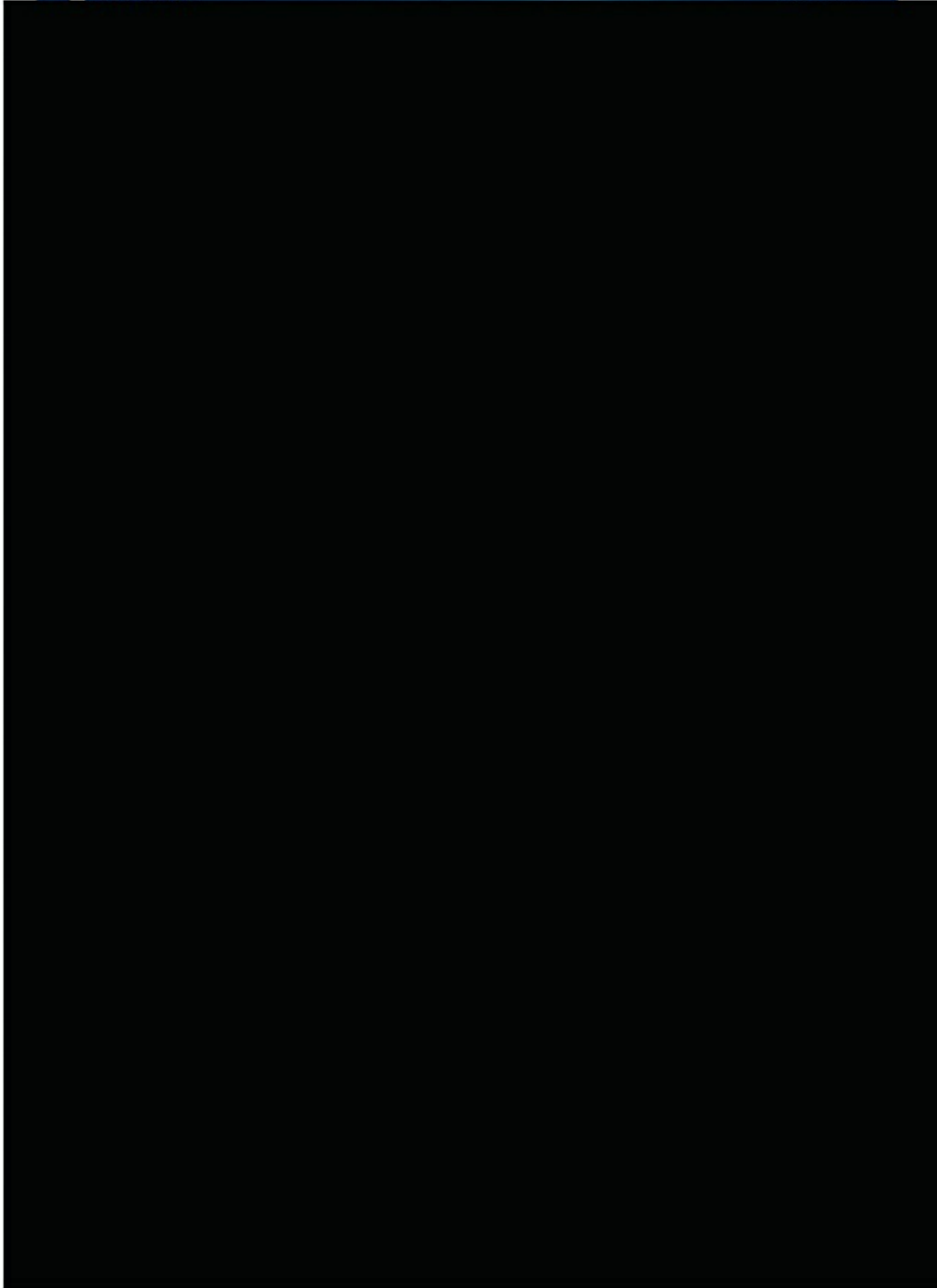
[Redacted]

[Redacted]



[Redacted]

[Redacted]



4.13 Pressure housing

4.13.1 Design and types

Several pressure housings are available depending on the user requirements. SubCtech provides a complete one-hand solution with battery, housing, connectors as well as training and support. Due to our own production facilities we provide any size of housing, not restricted by standard dimensions.

All SubCtech instrumentation (Data logger, batteries, sensors etc.) are typically equipped with titanium housings for long-time deployments and operating depths up to 6000m. Others such as Super-Duplex for offshore Oil+Gas, POM or Aluminum are provided as well.



Image 33: Example of large subsea battery: 3000m



Image 34: Example of subsea battery: 6000m

4.13.2 Calculation


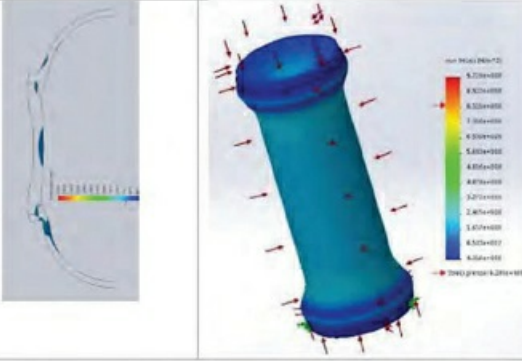
All material is tested and equipped with a material certificate. Our pressure housings are calculated and simulated by FEM software in order to optimize weight and size. After the production the housings will be type-approved by pressure tests.

We provide a FEA and structural analysis of the material selection based on the requirements. In addition, the proposal includes FAT and qualification, with hyperbaric pressure testing of the canister(s). Any CPI as well as procedures for integration, installation and/or testing may result in changes.

SubCtech GmbH
Wellseedamm 1-3 • D-24145 KIEL • Germany
Managing Director: Dipl.-Phys. Stefan Marx
Amtsgericht Kiel HRB 11552 KI
VAT-Id.No. DE270099549

phone: +49 (0) 431-22039880
fax: +49 (0) 431-22039881
mobile: +49 (0) 178-35 21 99 2
email: info@subctech.com
web: www.subctech.com

Bank: Foerde Sparkasse
IBAN: DE92 2105 0170 1400 0559 58
BIC: NOLADE21KIE
The protection notice ISO 16016 applies to the content of this document.

	
<p>Image 35: FEM values for titanium grade5.</p>	<p>Image 36: Example simulations of pressure housing proofing the max. stress (tension) and collapsing parameter. In the graphic above stress and housing bending is overdrawn.</p>

4.14 Pressure tests

All new pressure vessels are checked by us. The pressure is simulated first by professional FEM software tools. We optionally offer individual tests, or test according to API17F and other regulations.

We work with the following facilities (not limited to):

- GEOMAR Kiel
- KUM Kiel
- Uni Rostock
- Nautilus Bremerhaven
- MacArtney, Denmark
- IFREMER, France



All facilities allows test up to 600 Bar, with different sizes.

SubCtech GmbH
 Wellseedamm 1-3 • D-24145 KIEL • Germany
 Managing Director: Dipl.-Phys. Stefan Marx
 Amtsgericht Kiel HRB 11552 KI
 VAT-Id.No. DE270099549

phone: +49 (0) 431-22039880
 fax: +49 (0) 431-22039881
 mobile: +49 (0) 178-35 21 99 2
 email: info@subctech.com
 web : www.subctech.com

Bank: Foerde Sparkasse
 IBAN: DE92 2105 0170 1400 0559 58
 BIC: NOLADE21KIE
 The protection notice ISO 16016 applies to the content of this document.

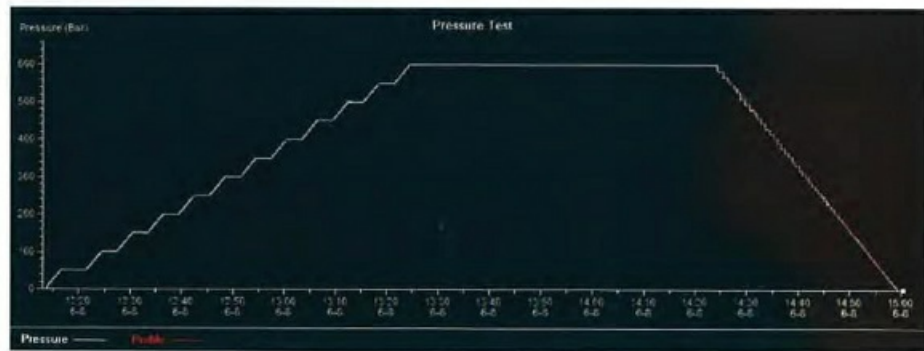


Image 37: Example test of a large 6000m housing with 600 Bar test pressure. (Test by MacArtney, Denmark)

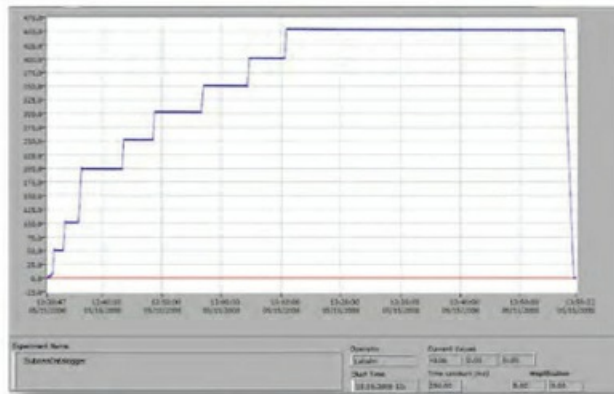


Image 38: Example test of a 4000m housing with 450 Bar test pressure.

4.15 Connectors

4.15.1 Internal Connectors

For information on the battery connectors, please refer to the Interface Control Document (ICD).



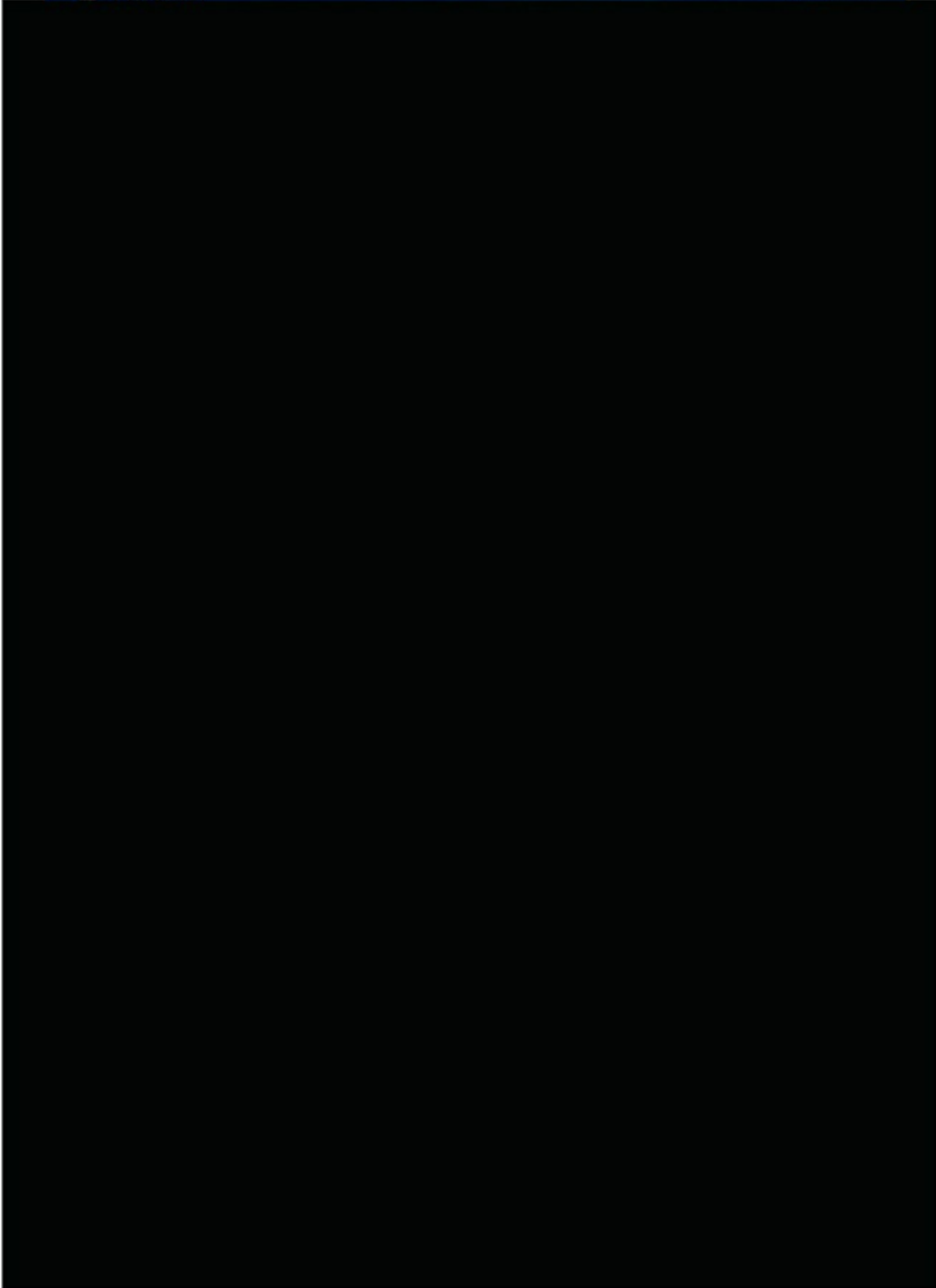
Image 39: Example of connector layout on the front plate of the battery.

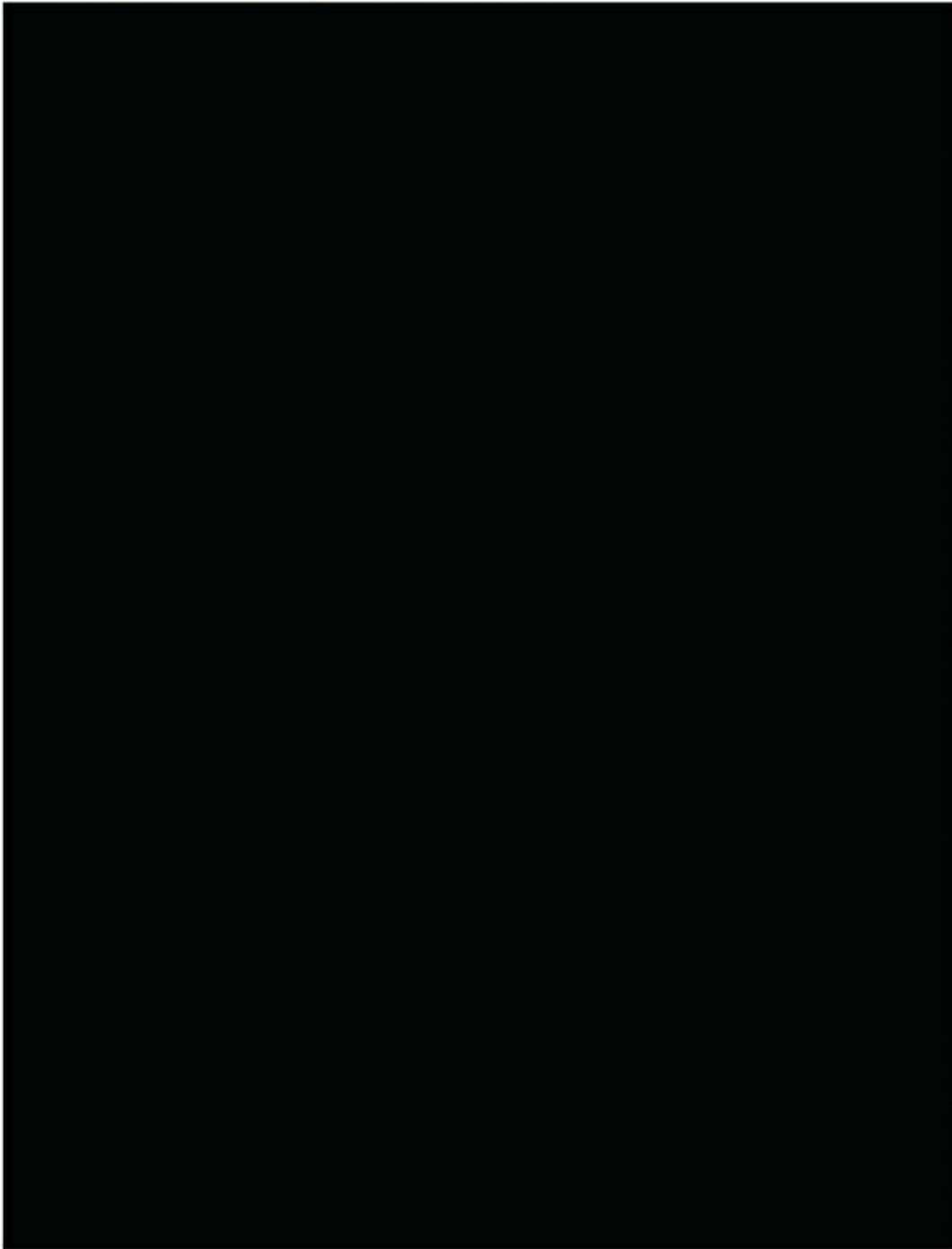
Port	Function	Connects to:
OCP	Output Control Port	Customer application, or PowerCharger (over SP)
EmbCP	Embedded Charge Port	Embedded Charger (EmbCDP)
CP	Charge Port	PowerCharger (over SP)
OPP	Output Power Port	Customer application
EPP	External Power Port	PowerCharger (over SP)

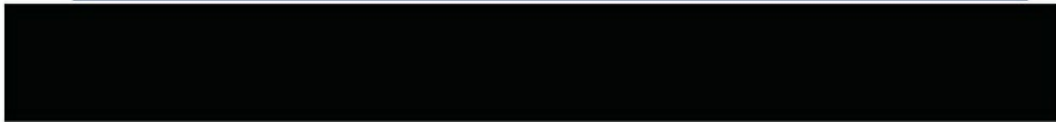
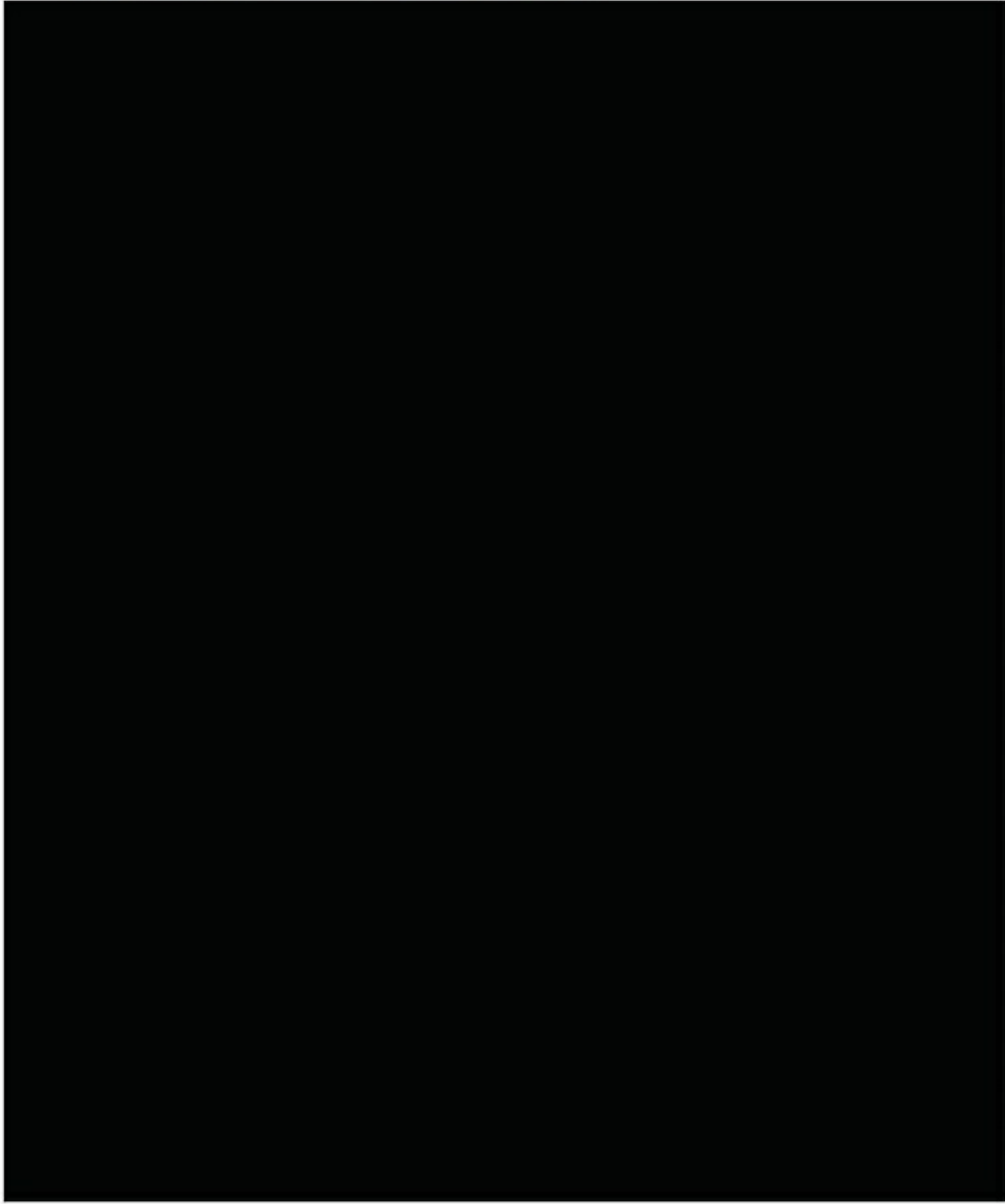
SubCtech GmbH
Wellseedamm 1-3 • D-24145 KIEL • Germany
Managing Director: Dipl.-Phys. Stefan Marx
Amtsgericht Kiel HRB 11552 KI
VAT-Id.No. DE270099549

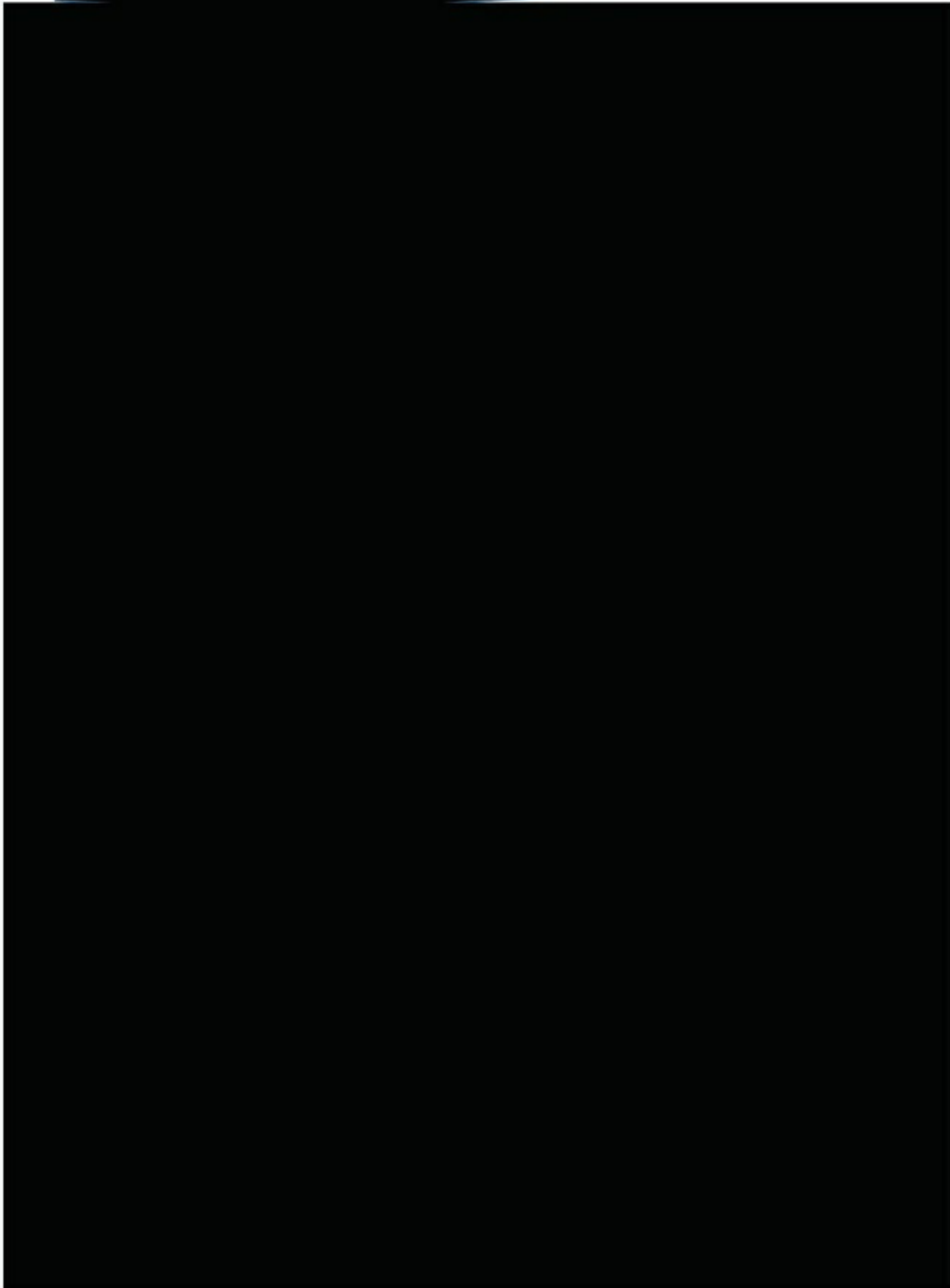
phone: +49 (0) 431-22039880
fax: +49 (0) 431-22039881
mobile: +49 (0) 178-35 21 99 2
email: info@subctech.com
web: www.subctech.com

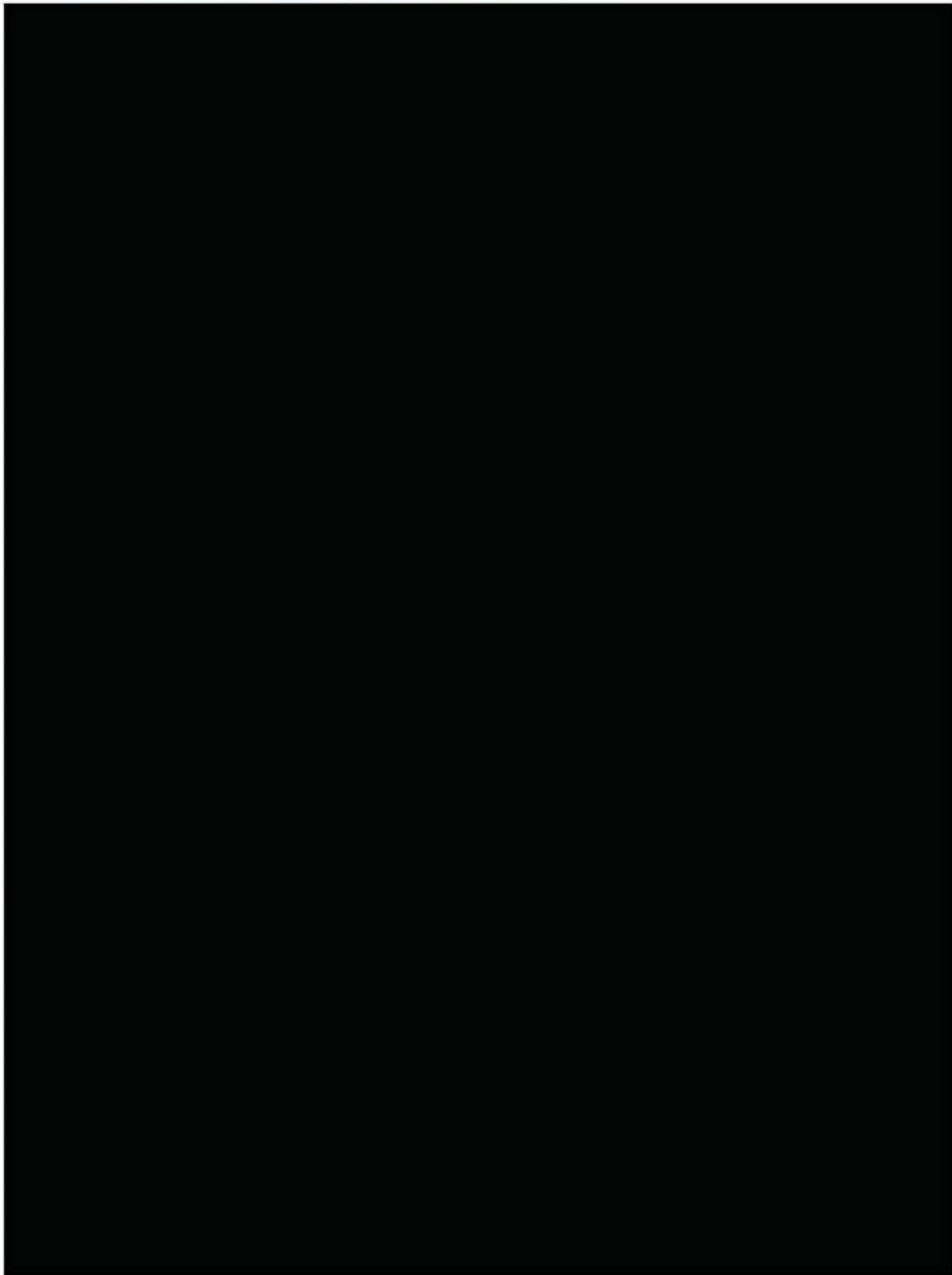
Bank: Foerde Sparkasse
IBAN: DE92 2105 0170 1400 0559 58
BIC: NOLADE21KIE
The protection notice ISO 16016 applies to the content of this document.











4.16 Top-Side Charger

4.16.1 External PowerCharger™ with diagnostic unit

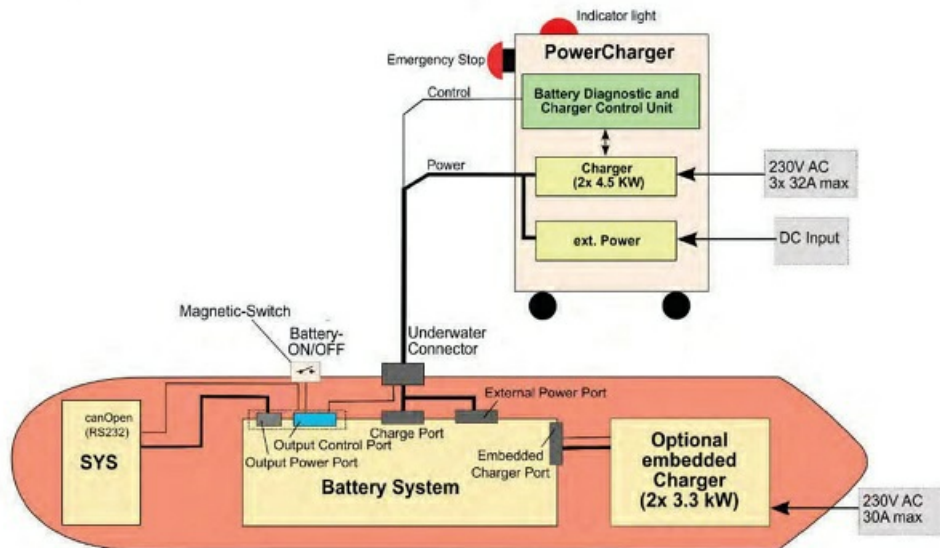


Image 46: Example of AUV battery system with Embedded Charger and External PowerCharger (overview only)

SubCtech GmbH
 Wellseedamm 1-3 • D-24145 KIEL • Germany
 Managing Director: Dipl.-Phys. Stefan Marx
 Amtsgericht Kiel HRB 11552 KI
 VAT-Id.No. DE270099549

phone: +49 (0) 431-22039880
 fax: +49 (0) 431-22039881
 mobile: +49 (0) 178-35 21 99 2
 email: info@subctech.com
 web: www.subctech.com

Bank: Foerde Sparkasse
 IBAN: DE92 2105 0170 1400 0559 58
 BIC: NOLADE21KIE
 The protection notice ISO 16016 applies to the content of this document.

4.16.2 What is new

The latest PowerCharger™ is comparable and mostly compatible to the existing PowerCharger™.

What is new:

- Service rear-flap for simplified maintenance
- BMS firmware update of the battery BMS via USB stick or SD card
- Data log download of the battery BMS via USB stick or SD card (up to 32GB)
- Using of small form-factor 3kW power supplies to reduce size and weight
- WYE with neutral line is not needed for these enhanced power module setup
- Compatible to the NEW embedded charger
- Optimized SmartCharge™ algorithm for faster charging: CC, CV, CP with BAL included

The so called PowerCharger™ provides energy to charge SubCtech's large batteries top-side / on-board. It consists of power supply units for one or multiple battery modules.

The charger is easy to operate under difficult conditions, but offers in-depth diagnostics if required. The battery can also be configured and updated. Log files are read out.

4.16.3 How it works

The so called PowerCharger™ is under full control of the battery BMS. It (can) consist of typically one high-power supply per battery module. Temperature effects, aging and voltage drops on cables or connectors will be compensated.

The PowerCharger™ is controlled by an industrial ARM STM32 microcontroller, using a 7" touch screen providing information for the user and to receive input from the user for testing and diagnostic in the lab. The PowerCharger™ is part of the SmartBMS and connected to the battery BMS controller for data exchange and double safety. Each part (charger and battery) can interrupt and stop charging to guarantee highest safety.

For safety purposes (in the lab for testing) there is an "EMERGENCY STOP" button at the top of the housing to interrupt the charging process. For error messaging there is a blink lamp installed on top of the housing.

The optional installed electrical load further enhances the diagnostic capabilities. E.g. it enables measuring of the real battery capacity and allows discharging the battery to a certain level for storage purpose.

For external testing, a real-time data output and USB storage port is provided.

The PowerCharger™ can be used as external power supply, and diagnostic + test unit, e.g. for FAT, UAT or service such as capacity testing.

SubCtech GmbH
Wellseedamm 1-3 • D-24145 KIEL • Germany
Managing Director: Dipl.-Phys. Stefan Marx
Amtsgericht Kiel HRB 11552 KI
VAT-Id.No. DE270099549

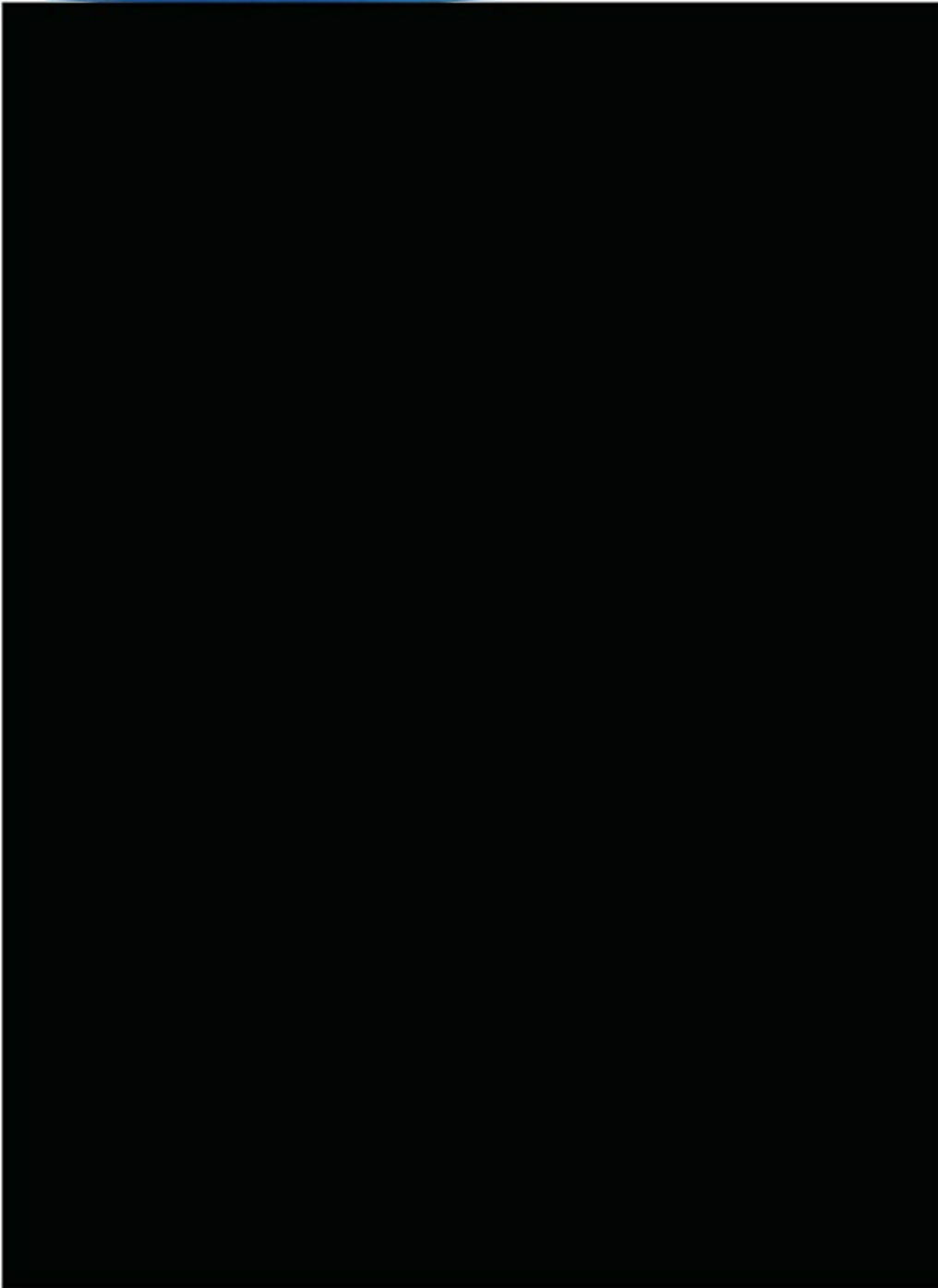
phone: +49 (0) 431-22039880
fax: +49 (0) 431-22039881
mobile: +49 (0) 178-35 21 99 2
email: info@subctech.com
web: www.subctech.com

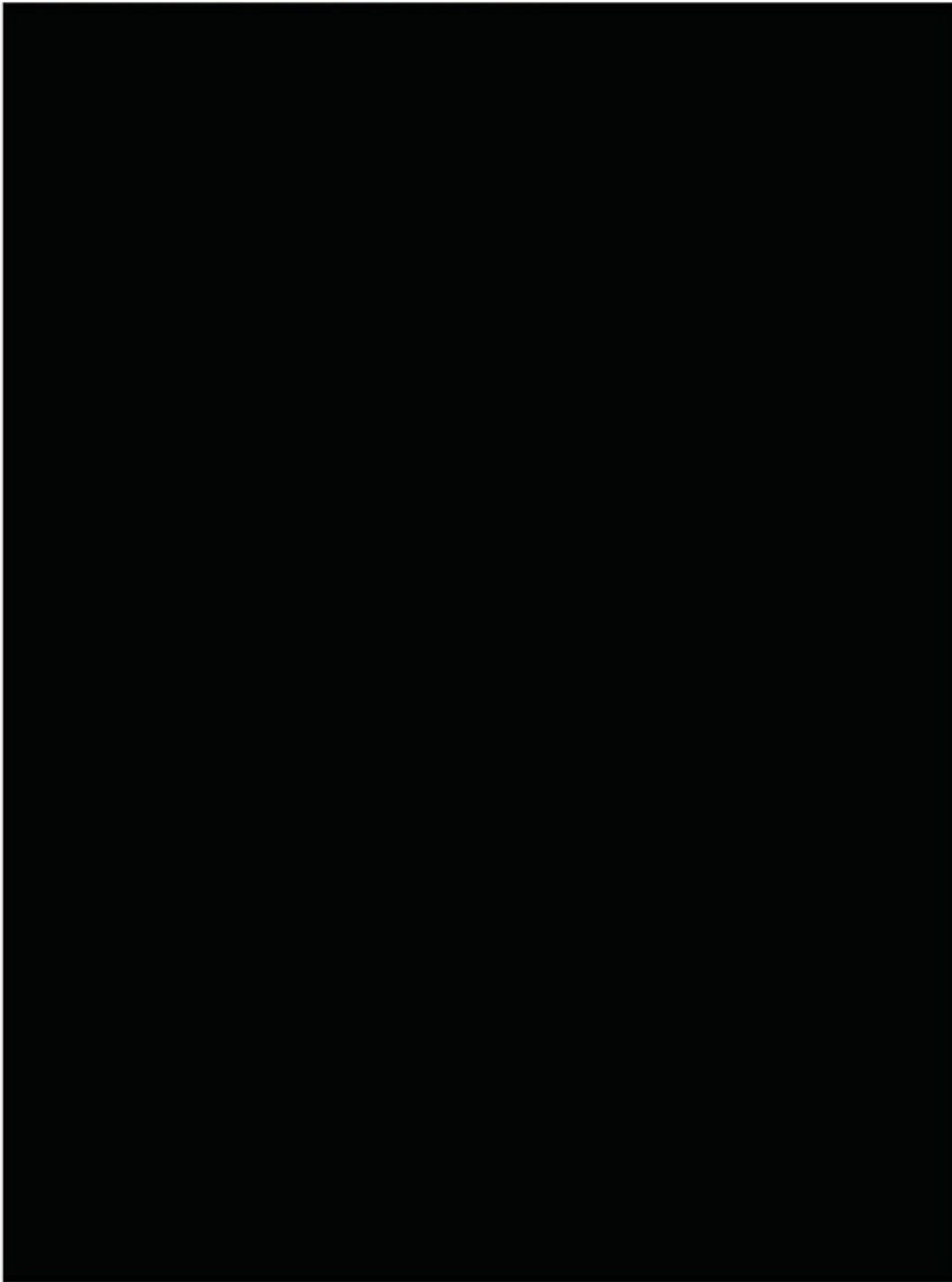
Bank: Foerde Sparkasse
IBAN: DE92 2105 0170 1400 0559 58
BIC: NOLADE21KIE
The protection notice ISO 16016 applies to the content of this document.

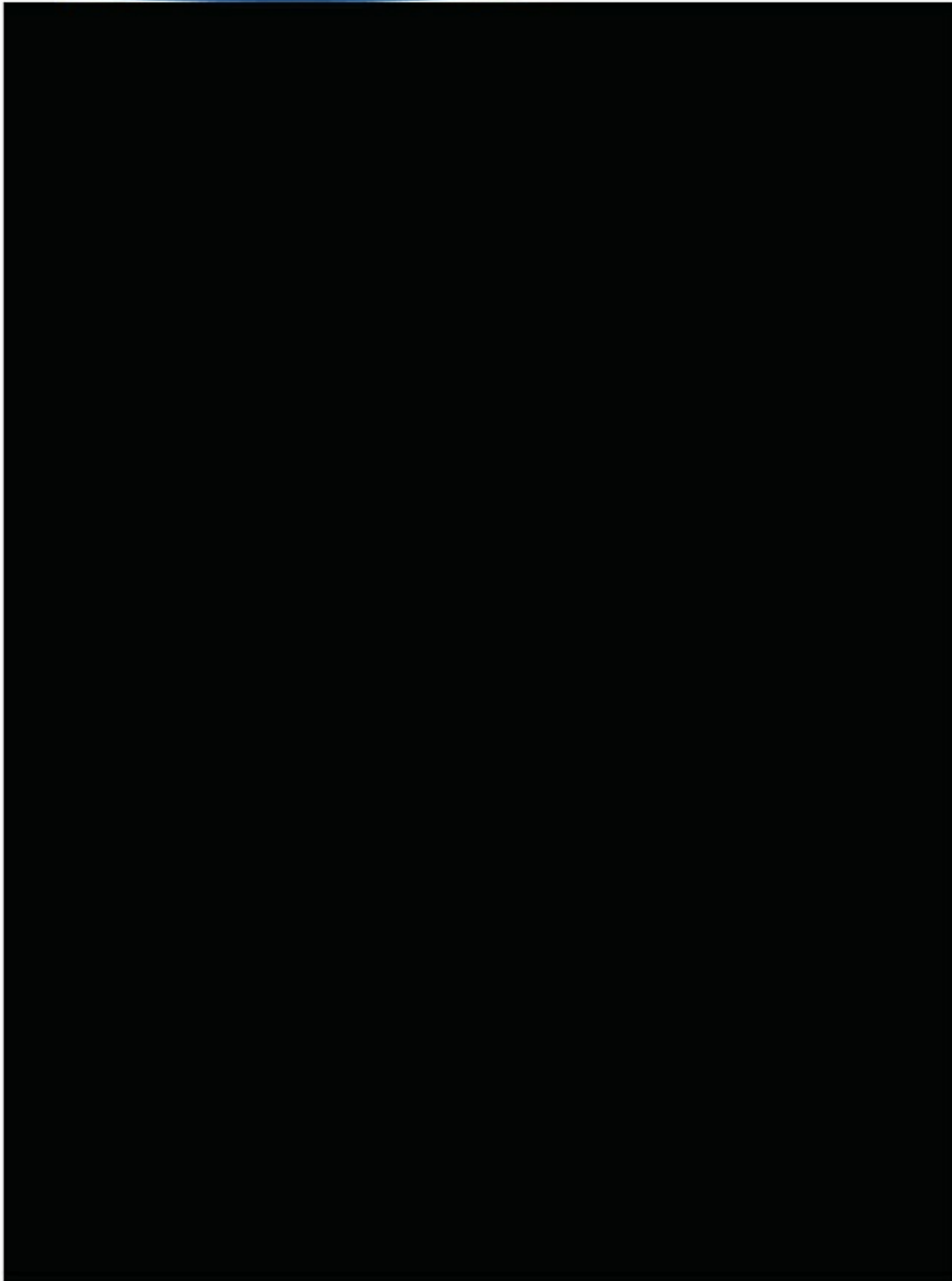
The system rack itself is constructed robust enough to be placed on board. Eyebolts allow lifting the system by a crane while wheels make the rack mobile on the deck.

Operation

- The modules or pressure housing must *not* be opened or vented during charging. In fact, you can charge in water. Venting of cells is not possible, and power dissipation is under full multi-level control.
- Cell balancing is done within the battery and is controlled by the master controller together with the charger controller.
- The SOC of each module is tracked and balanced against all other. This feature is important to guarantee identical SOC values of all modules, for later optimal balanced power load. Only with optimal balanced power load, all modules will be identical discharged – and the battery system can provide the total max. power load.
- For low temperature charging (below 0°C), the internal BMS controls the charging process to operate only in the valid temperature range.
- With the "Constant Power" charging, the charge time is drastically shorten compared to standard CC/CV algorithm. Our new enhanced adapted balancing algorithm and CP charging take care on heating due to high power dissipation and special cell chemistry, and will accelerate charging a lot. Nethertheless, ultra-quick charging compared to fluid-cooled EVs is not recommended due to safety and reliability / aging reasons.
- During the charging process it captures battery parameters like charging voltage, charging current, cell voltages, battery temperature and some more on SD card in ASCII formatted text.







4.16.7 Construction

The charger rack itself is constructed robust enough to be placed on board. Eyebolts allow lifting the system by a crane while wheels make the rack mobile on the deck.

The design and the components of the 19" flight-case charger are based on the already qualified ruggedized 19" rack charger with its special non-standard rack enclosure. In contrast, the flight-case housing is COTS and already ruggedized. It was selected based on market requirements for robustness, mobility, standardized components and service friendliness. The 19" flight-case charger is normally operated with open lids (IP42). Optionally, it can be modified so that it can be operated closed like the ruggedized 19" Rack charger (IP54), but serviceability is limited in this case.



Image 58: ruggedized 19" flight-case enclosure, open for operation

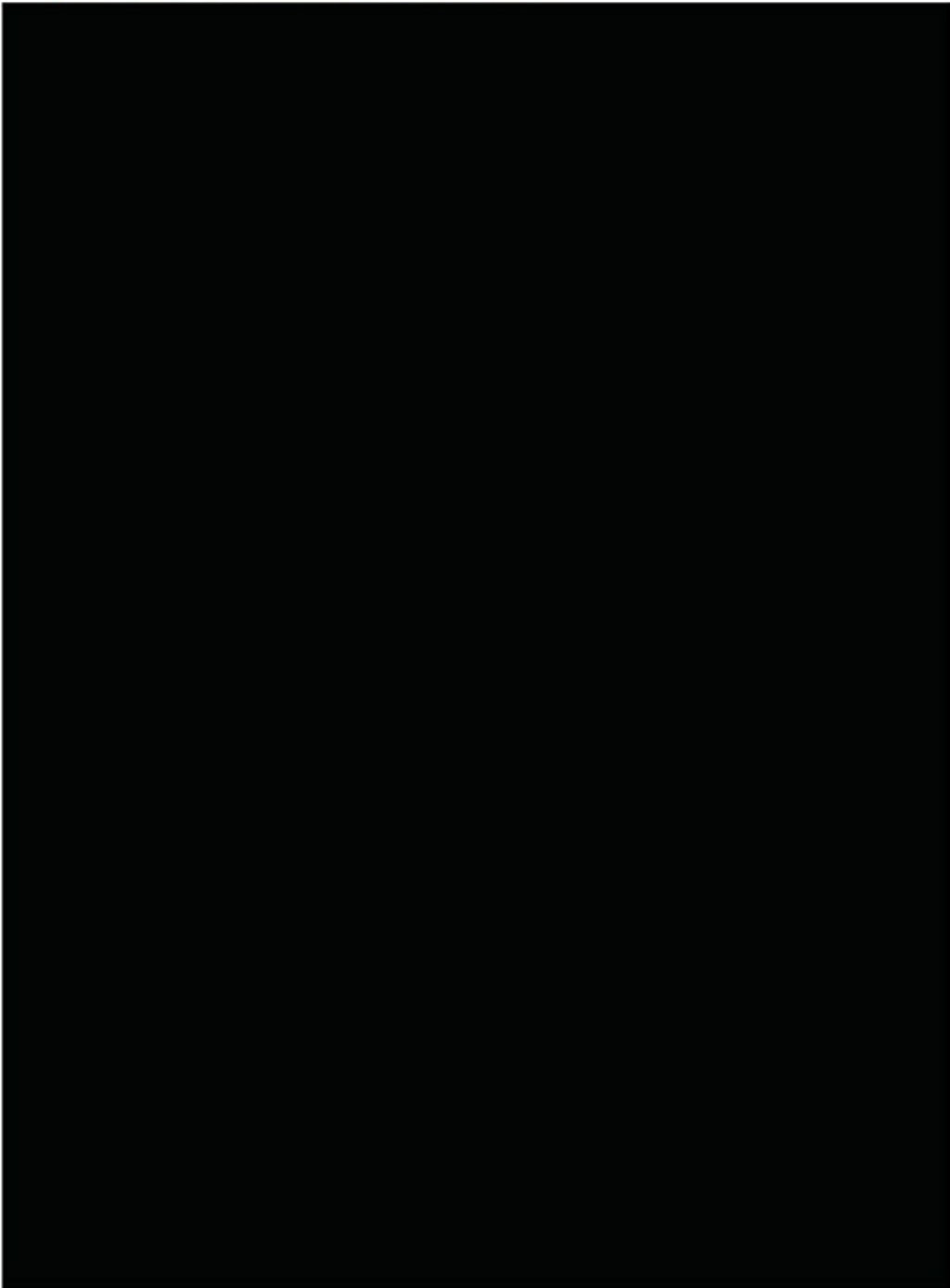
Image 59: ruggedized 19" flight-case enclosure, closed for transport

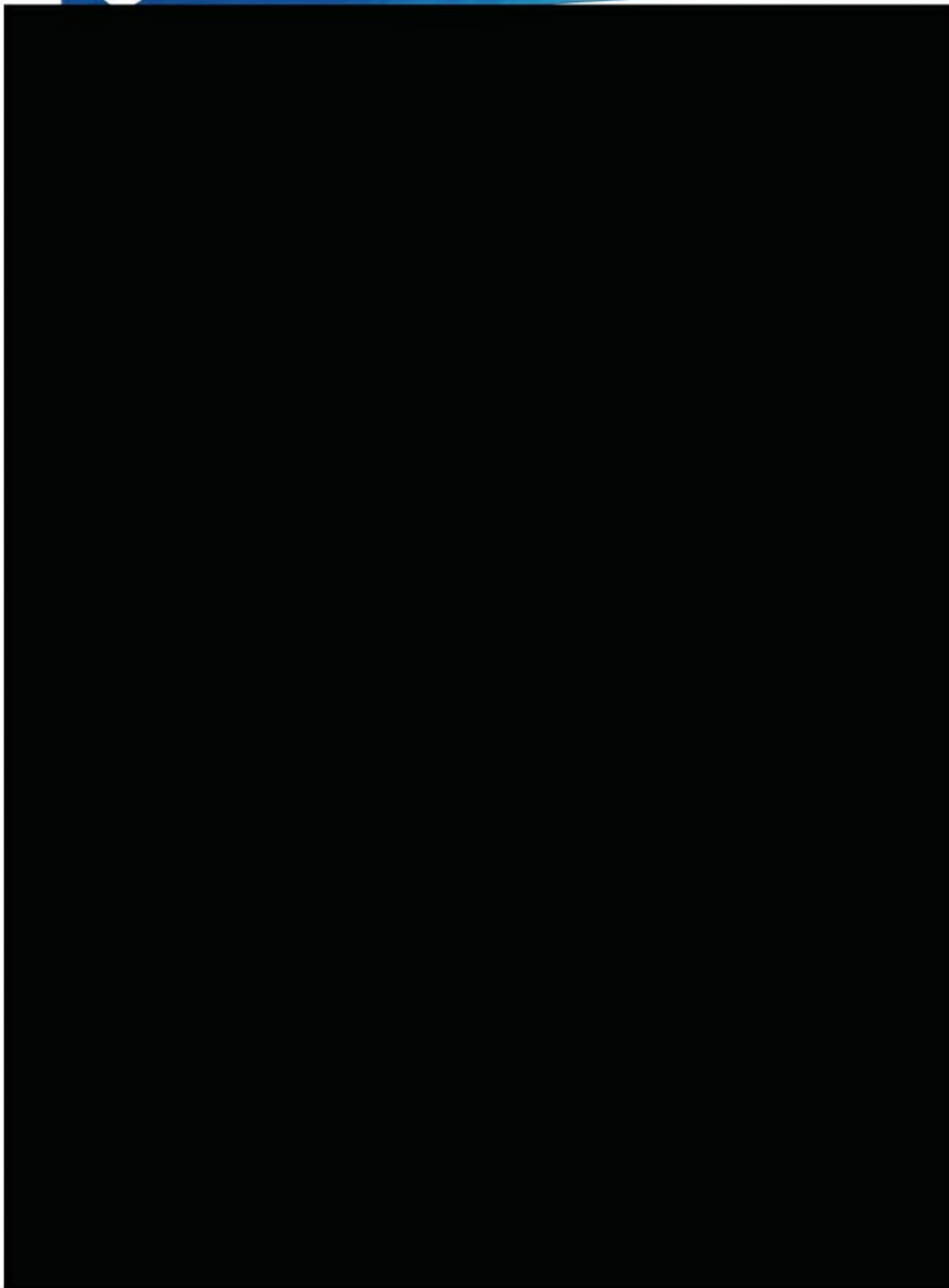


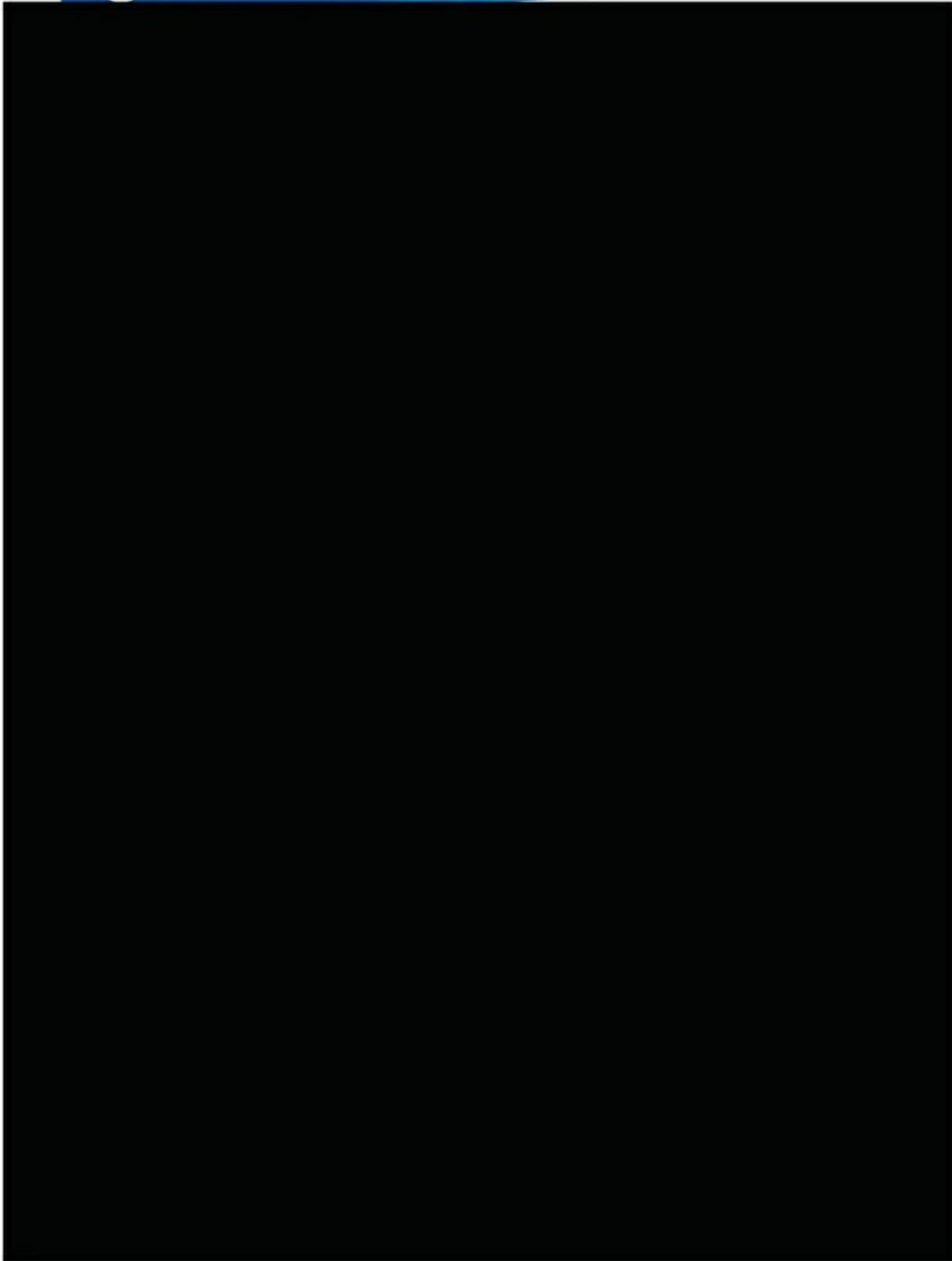
Image 60: protected rear connections, ruggedized 19" rack

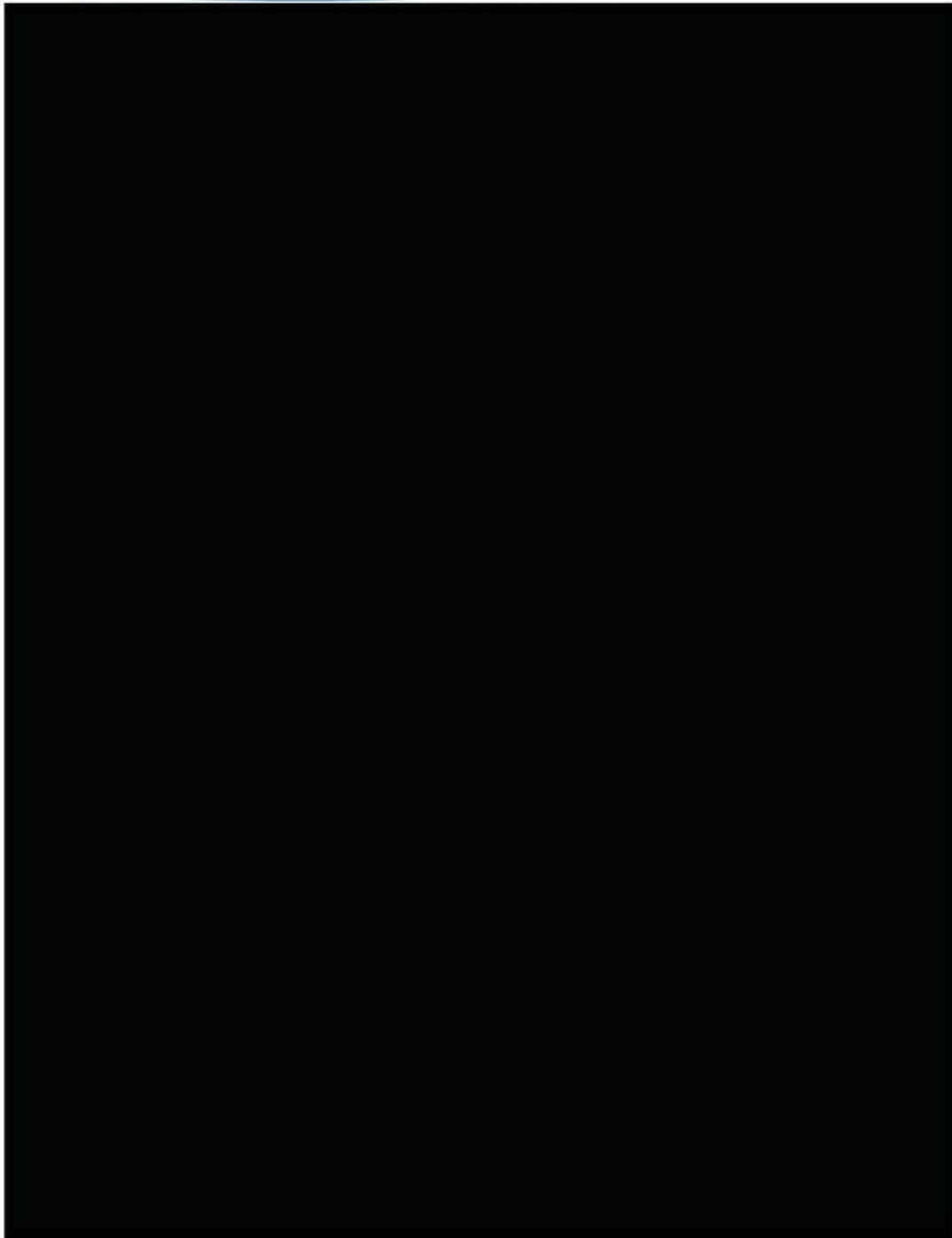


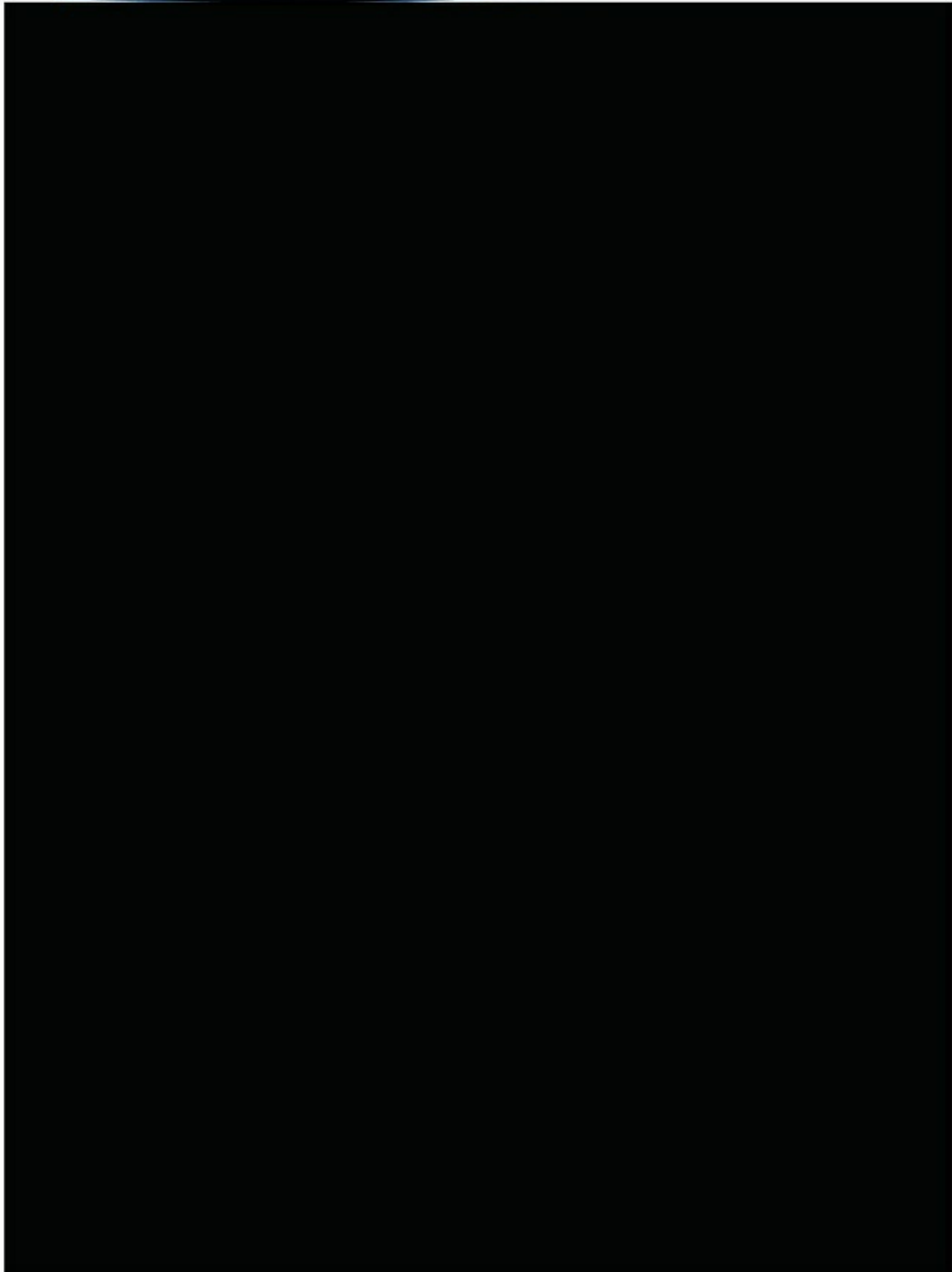
Image 61: Example of an opened rear-side 19" Flight-Case PowerCharger™

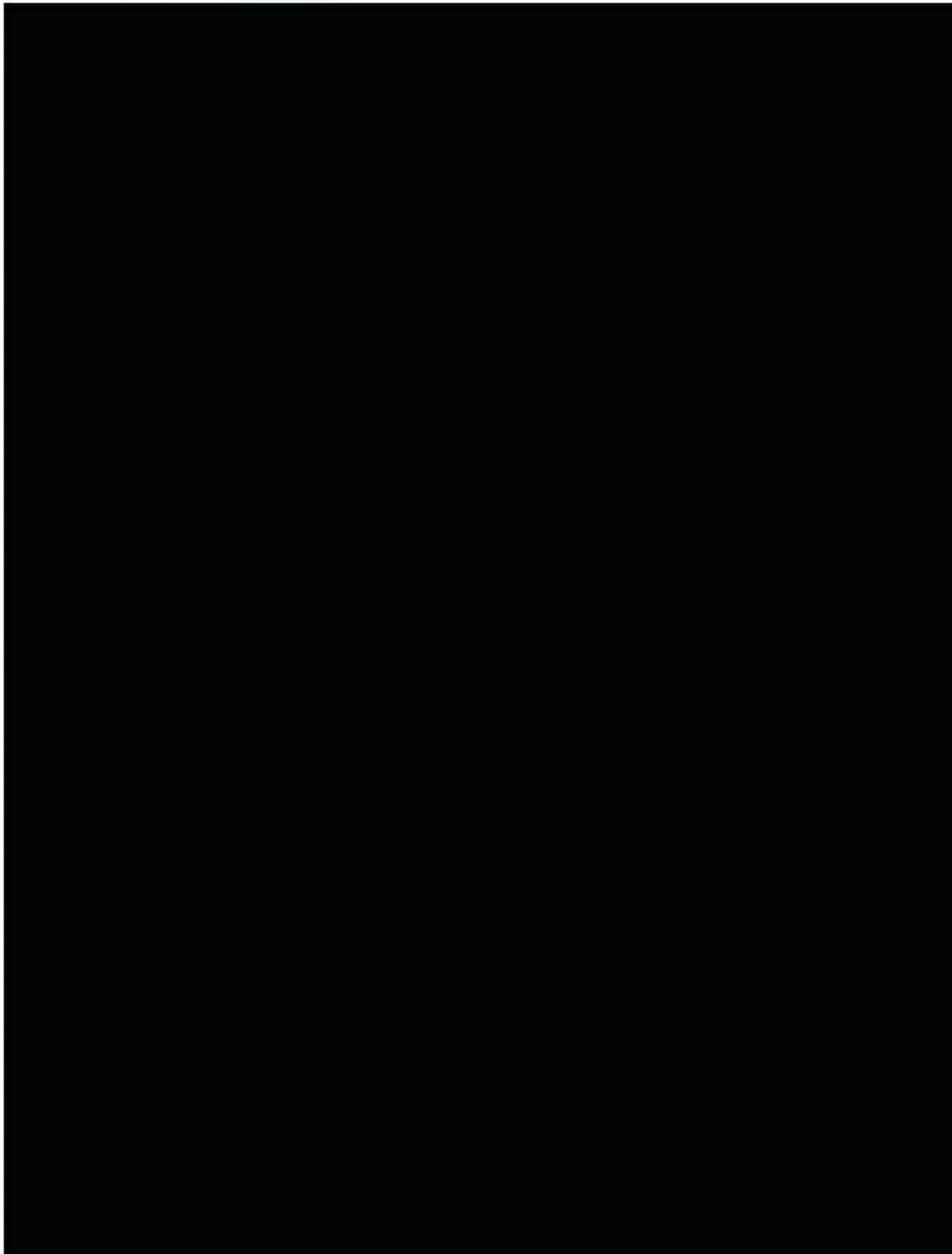


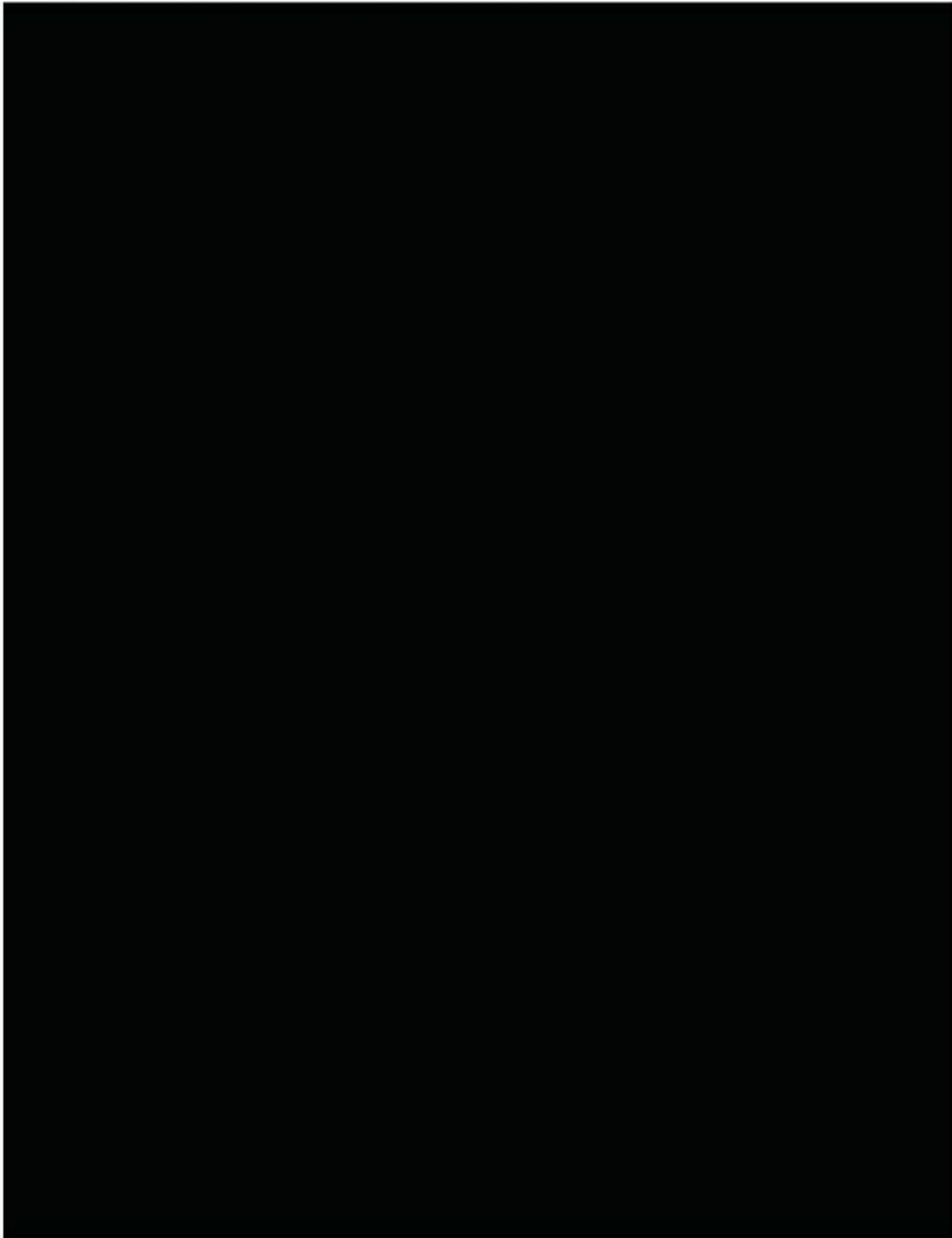












4.19 Qualifications

4.19.1 API17F or MIL-STD qualification

The components are already qualified according API17F, ISO 13628-6, MIL-STD or other. Because the project schedule is short, we recommend performing Q1 tests with optional additional EMC testing. The Q2 tests should be performed on module level for S&V, and on battery level for pressure testing and EMC.

For Q1 testing, we construct a robust bread board design. For this proposal, we considered a full test procedure.

For more details, please see the following technical description below.

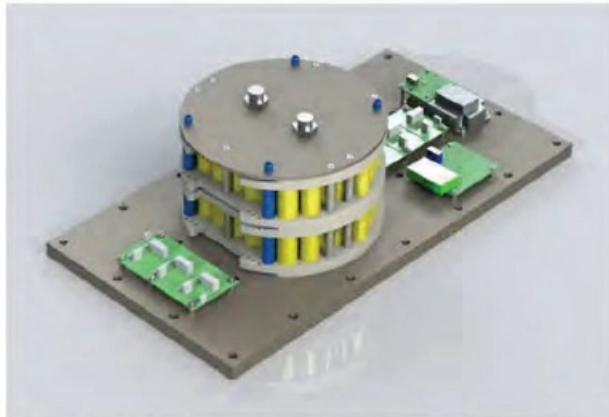


Image 69: Test setup for Q1 testing of Master-BMS, Slave-BMS, SPB battery module, switch module etc.

SubCtech GmbH
Wellseedamm 1-3 • D-24145 KIEL • Germany
Managing Director: Dipl.-Phys. Stefan Marx
Amtsgericht Kiel HRB 11552 KI
VAT-Id.No. DE270099549


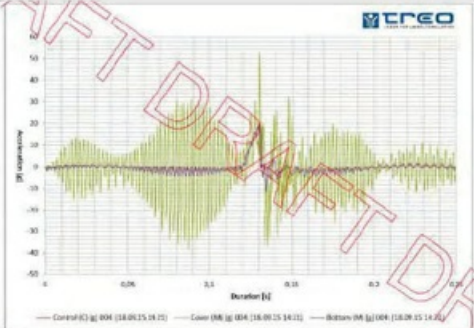

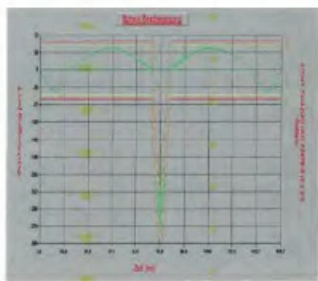
phone: +49 (0) 431-22039880
fax: +49 (0) 431-22039881
mobile: +49 (0) 178-35 21 99 2
email: info@subctech.com
web: www.subctech.com

Bank: Foerde Sparkasse
IBAN DE92 2105 0170 1400 0559 58
BIC NOLADE21KIE
The protection notice ISO 16016 applies to the content of this document.

4.19.2 Shock & Vibration

Shock should not exceed $\pm 20g$, if prepared for high-reliability applications. A procedure is recommended during maintenance and transportation to protect the battery system. The battery system can be easily transported in the supplied transportation cases. Our test according to MIL-STD 810G and ISO 13628-6 are performed up to $\pm 40g$.

Typical example procedure for testing (photos comparable only):

	
<p>Image 70: Shock & vibration tests according to MIL-STD 810G on SPB level (SmartPowerBlock™) with BMS Master installed, during operation cases</p>	<p>Image 71: Shock and vibration test report of a SPB in the range of -40g to +50g, for the setup on the left photo.</p>
	 <p> Meßwert: 1,108 kg Hersteller: ... Spezifikation: ... Technische Zeichnung (Zustand): ... Produktion: ... </p>
<p>Image 72: Shock & vibration tests of SEM battery modules according to API17F / ISO 13628-6, during operation cases</p>	<p>Image 73: Shock test report up to $\pm 30g$, for the setup on the left photo.</p>

SubCtech GmbH
 Wellseedamm 1-3 • D-24145 KIEL • Germany
 Managing Director: Dipl.-Phys. Stefan Marx
 Amtsgericht Kiel HRB 11552 KI
 VAT-Id.No. DE270099549

phone: +49 (0) 431-22039880
 fax: +49 (0) 431-22039881
 mobile: +49 (0) 178-35 21 99 2
 email: info@subtech.com
 web: www.subtech.com

Bank: Foerde Sparkasse
 IBAN: DE92 2105 0170 1400 0559 58
 BIC: NOLADE21KIE
 The protection notice ISO 16016 applies to the content of this document.

4.19.3 EMC Characteristic and Test

The EMC radiation is minimized by special internal and external wiring, special position of all single cells etc. The minimized EMC radiation feature was already used for military and Oil & Gas exploration applications.

A complete test of the magnetic structure can be performed with our accredited cooperation partner. EMC-testing of grid-emitted and radiation-emitted interference immunity properties in accordance with EN 61000-4-x and on-site measurements of electro-magnetic environmental compatibility can be provided.

For the method it is recommended using GL guidelines according to other sea and offshore regularises. GL is widely comparable to MIL-461F. The test device consists of electronic, battery pack and housing. The tests are performed under operating conditions (charge and optional discharge) including data transfer.

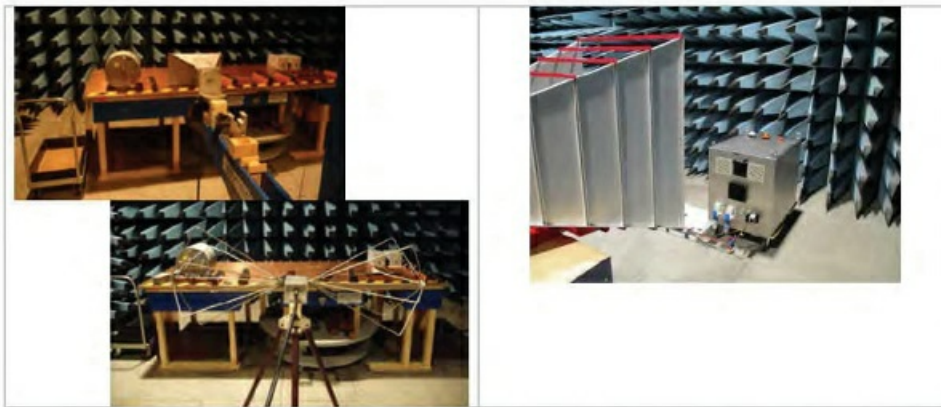


Image 74, Image 75: Different setups are used to measure and test radiated emission, susceptibility, conducted emission.

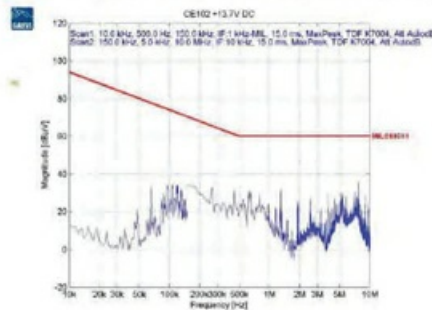
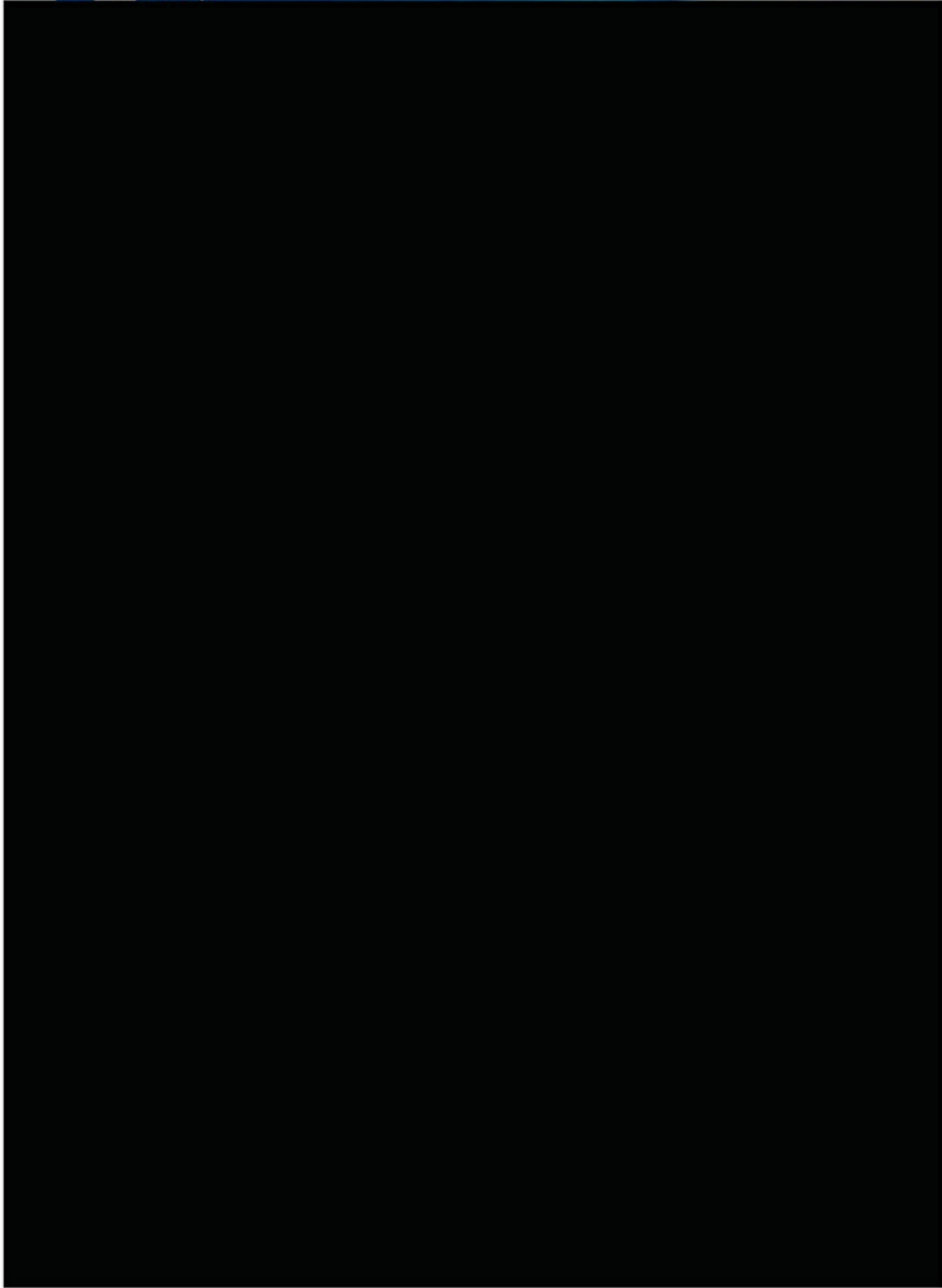


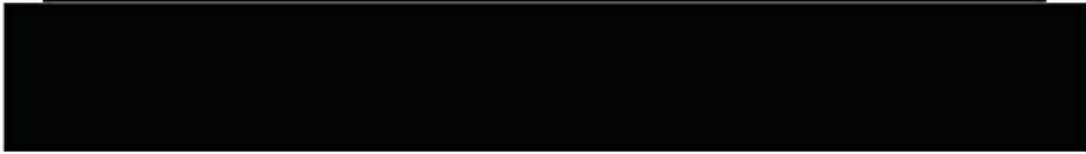
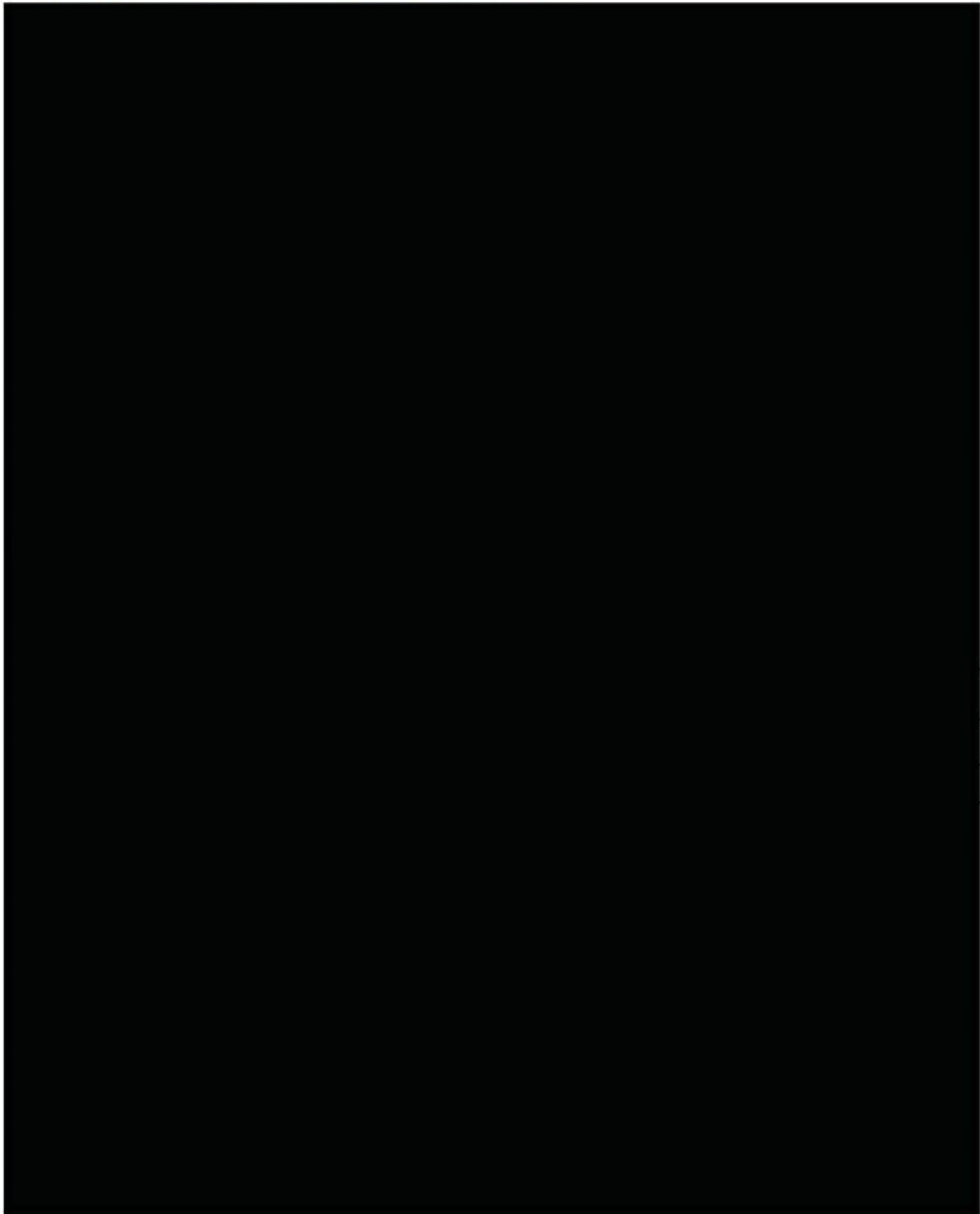
Image 76: Typ. result for testing conducted emission 30Hz to 10kHz (not in the graph) and 10kHz to 30MHz according MIL-STD 461F. © SubCtech

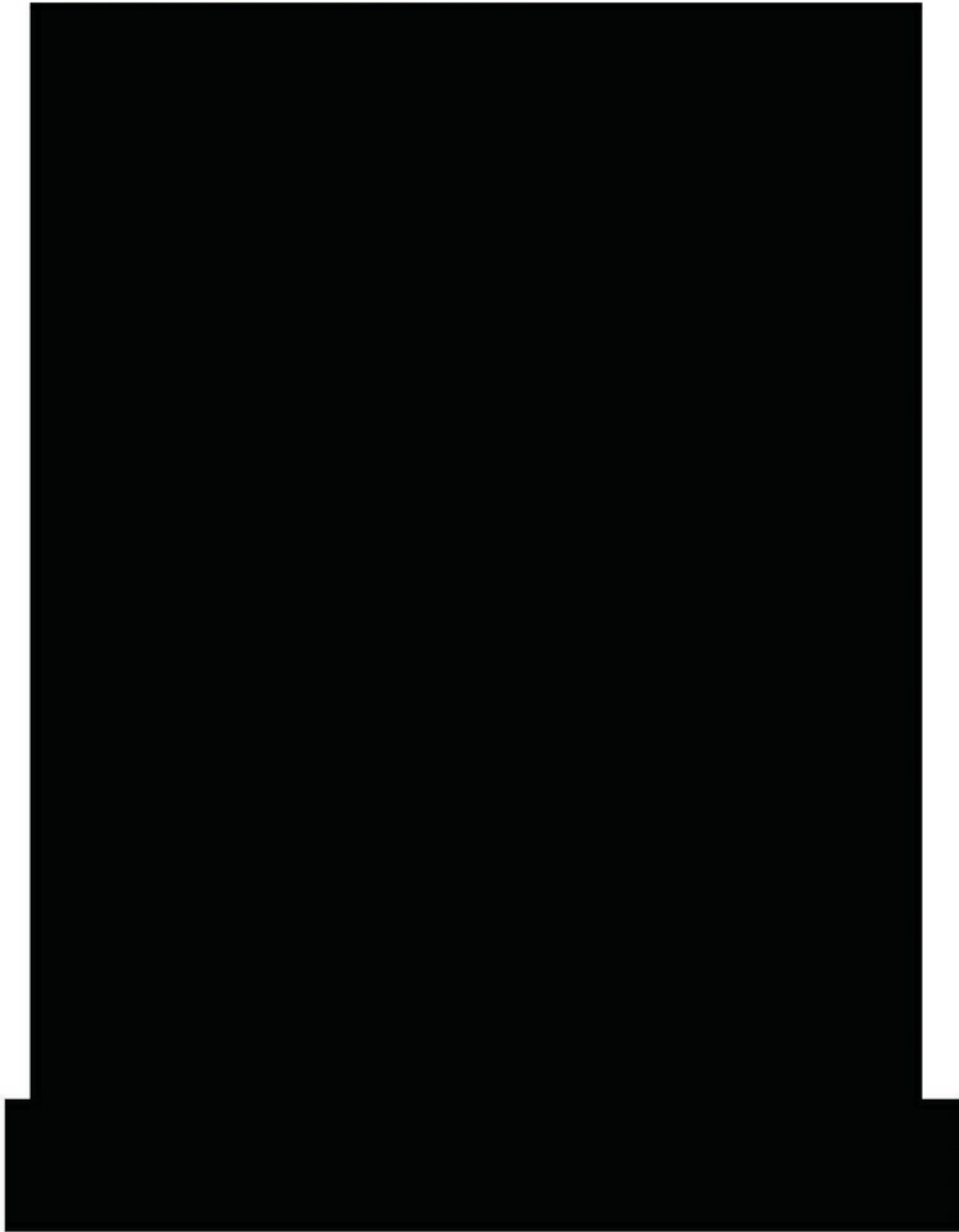
SubCtech GmbH
Wellseedamm 1-3 • D-24145 KIEL • Germany
Managing Director: Dipl.-Phys. Stefan Marx
Amtsgericht Kiel HRB 11552 KI
VAT-Id.No. DE270099549

phone: +49 (0) 431-22039880
fax: +49 (0) 431-22039881
mobile: +49 (0) 178-35 21 99 2
email: info@subctech.com
web: www.subctech.com

Bank: Foerde Sparkasse
IBAN: DE92 2105 0170 1400 0559 58
BIC: NOLADE21KIE
The protection notice ISO 16016 applies to the content of this document.







4.21 Support, Services and Processes

4.21.1 Meetings and training

Installation support and training is provided at the user site as a complete package. During the Installation, Harbour acceptance test (HAT) and Sea Acceptance Test (SAT) SubCtech provides training. The training is divided into background and specific knowledge. Following the HAT, the team should be able to perform first jobs on sea parallel the SAT.

Included:

- Training and installation support on the site
- Unlimited number of participants
- Duration e.g. 3-5 days incl. travel time
- Employers or specialists by SubCtech staff
- Incl. travel costs, flight, accommodation and daily rates

Exceptions / excluded:

- Any external costs such as rents, insurance or other e.g. operational costs for e.g. for vessels, locations, transport etc.
- Any personal costs such as travel costs, flight, accommodation and daily rates for the participants
- Any cost or e.g. contracts to other companies
- Any costs regarding the participants (accommodation, travel, meals, etc.)
- Translation of any documents other as English (available on request)
- Other such as any cost operating the system, any vessel operating costs, any customer insurances

Additional or extra personal support is available.

Possible project meetings

- Pre-consulting
- Kick-off meeting at the customers site
- Working meetings on a regularly base e.g. all 2 months
- Web meetings (video, mail, telephone) on demand or on a regularly base
- Producers short progress reports on a regularly base e.g. every month
- Control meetings on producers site on demand
- FAT at producers site
- Hand-over and 1st training at customers site (HAT)
- Sea trial and 2nd training at customers site (SAT)

SubCtech GmbH
Wellseedamm 1-3 • D-24145 KIEL • Germany
Managing Director: Dipl.-Phys. Stefan Marx
Amtsgericht Kiel HRB 11552 KI
VAT-Id.No. DE270099549

phone: +49 (0) 431-22039880
fax: +49 (0) 431-22039881
mobile: +49 (0) 178-35 21 99 2
email: info@subctech.com
web : www.subctech.com

Bank: Foerde Sparkasse
IBAN: DE92 2105 0170 1400 0559 58
BIC: NOLADE21KIE
The protection notice ISO 16016 applies
to the content of this document.

4.21.2 Service (After-sales)

Typical, the customers given factory acceptance test (FAT) will be performed from SubCtech personal due to the quality control before shipping and will be well documented. The test can be performed at SubCtech premises together with customers personal and during the handing over.

A training session during the handover will be provided, location either at SubCtech or at the customers' location can be chosen by the customer.

Technical support for the installation and final user acceptations test (UAT) is provided during the training session. Additional sea acceptance tests (SAT) may follow.

Training in Germany before delivery is welcome and free of charge.

4.21.3 Optional 24/7 support hotline, per year

Extended maintenance included:

- Duration one year
- 24/7 telephone hot-line with 24 hour response time per E-mail or telephone
- Maintenance support (remote only)
- Spare parts on stock
- Free software updates if available (consists of all originally ordered functions)

Exceptions / not covered:

- Shipping costs, tax, shipping insurance, if required customs
- Service on the site, travel or personal costs
- Damages or failures by external actions, e.g. stormy weather conditions, Bio-fouling
- Damages or failures by false handling or missing/less maintenance of any person

4.21.4 Optional Expanded warranty, 3 years

This warranty extends the standard warranty by two years to total 3 years. The standard warranty is not affected and valid for the first year.

Extended warranty period included:

- Duration three years (instead of 1 year)
- Warranty on all hardware components
- Maintenance support (remote only) within 2 days' reaction time max.
- Free software updates if available (consists of all originally ordered functions)

For your convenience, we additional provided with this warranty:

- Maintenance support (remote only by mail/phone) within 2 days' reaction time
- Free software / firmware updates if available (consists of all originally ordered functions)
- Consulting support for further installations, upgrades or adoptions to this system

Exceptions / not covered:

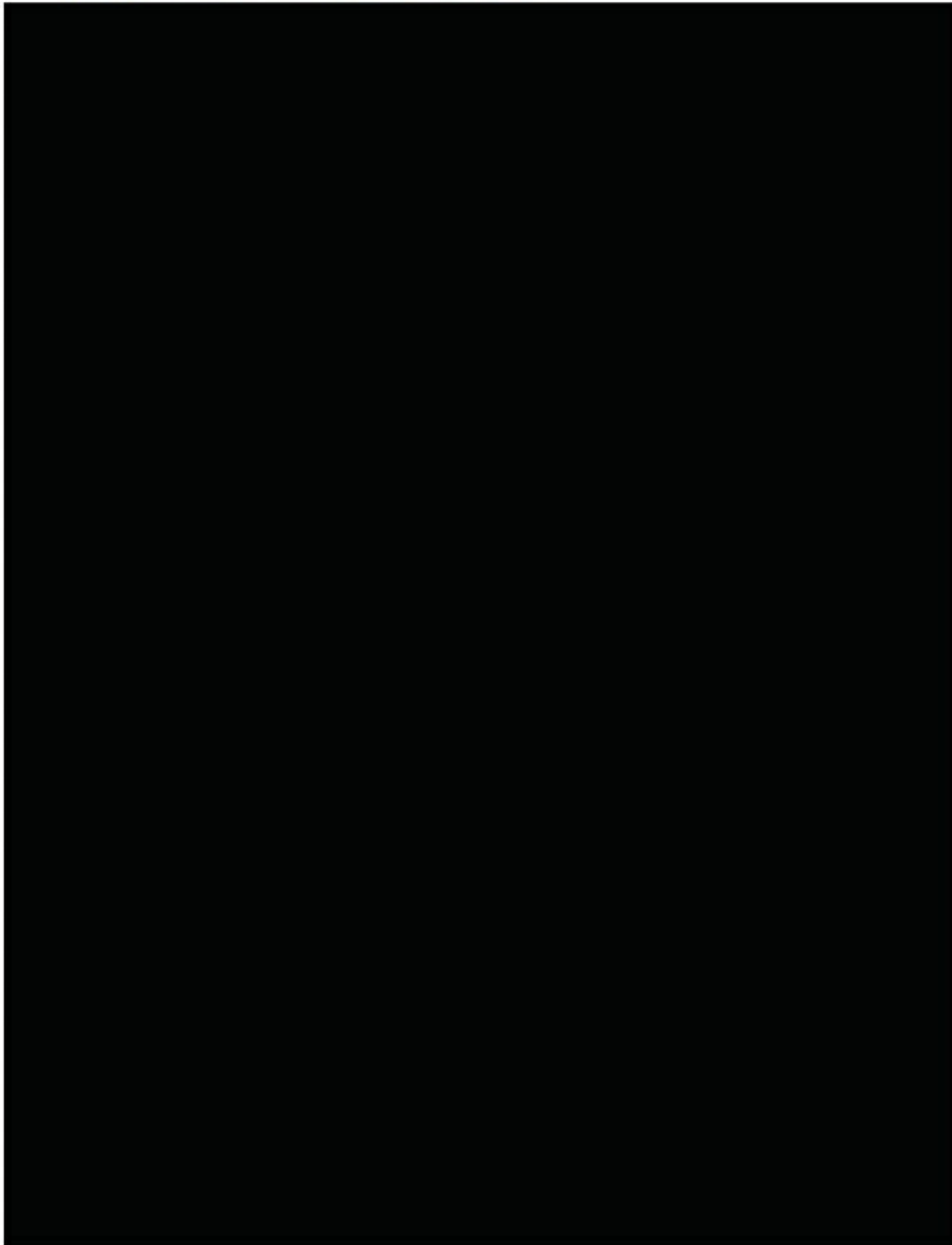
- Sealings, any consumables
- Shipping costs, tax, shipping insurance, if required customs
- Service on the site, travel or personal costs
- Damages or failures by external actions, e.g. stormy weather conditions, Bio-fouling
- Damages or failures by false handling or missing/less maintenance of any person

SubCtech GmbH
Wellseedamm 1-3 • D-24145 KIEL • Germany
Managing Director: Dipl.-Phys. Stefan Marx
Amtsgericht Kiel HRB 11552 KI
VAT-Id.No. DE270099549

phone: +49 (0) 431-22039880
fax: +49 (0) 431-22039881
mobile: +49 (0) 178-35 21 99 2
email: info@subctech.com
web : www.subctech.com

Bank: Foerde Sparkasse
IBAN: DE92 2105 0170 1400 0559 58
BIC: NOLADE21KIE
The protection notice ISO 16016 applies
to the content of this document.





4.21.6 Spare parts

Spare parts are provided for all electronic components and connectors, cables etc. Spare parts cover complete modules incl. all mechanics, BMS and wiring. Battery cells are not covered, but all our battery cells could be ordered to be on stock for quick repair if needed.

Complete spare batteries can be provided on request. In case of a failure it is recommended to use new cells from the manufacturer due to technical development is progressing. Please take into your account, that long-laying cells will not keep full performance.

The battery system doesn't consist of consumables. Service is not required inside the battery or charger.

Standard spare parts were provided:

- Complete set of screws, nuts etc.
- Complete set of spare connectors at battery side (no underwater connectors)
- Spare fuses, if applicable
- Spare industrial Compact-Flash or SD card if applicable, for each device.

4.21.7 Obsolescence management

SubCtech has an obsolescence management in place according the QMS, which already includes the development process and the whole lifetime of the system. Therefore, the risk of obsolete components is minimized.

For long-term life-cycles such as for subsea devices, we provide our active live obsolescence management to replace outdated components.

Spare parts are provided for all electronic components and connectors, cables etc. Spare parts cover complete modules incl. all mechanics, BMS and wiring. Battery cells are not covered, but all our battery cells could be ordered to be on stock for quick repair if needed. SubCtech stores spares of components not affected by aging and monitors the market for key components with a shorter lifetime, which cannot be stored for the whole lifetime of the system.

Complete spare batteries can be provided on request. In case of a failure it is recommended to use new cells from the manufacturer due to technical development is progressing. Please take into your account, that long-laying cells will not keep full performance.

In case of obsolete key components, the operator of the system is contacted and alternatives presented. It is although proposed how far the qualification of the system is affected by the change.

4.2.1.8 Transport

Li-Ion batteries need to be handled as dangerous goods according to UN class 9. These goods are only allowed to be transported considering the actual effective regulations and using compulsory wrapping and labelling.

This design may be approved according UN T38.3. SubCtech already approved batteries with external labs. Air transportation is restricted to cargo aircraft (no passenger aircraft) only (for more details see actual IATA Lithium battery guidance document).

Not every forwarding company is able to handle UN class 9 dangerous goods. Therefore, the transport needs to be planned well and the forwarding company has to be informed in advance. For the transportation via ship or airplane special documents (shipper's declaration) are required. These documents can be exposed by a trained person or the forwarding company. SubCtech is certified for any packing (street, seaways, air) according to ICAO, IATA DGR, ADR/RID and IMDG code, certified to provide and sign all necessary documents such as IMO (according B32F/438.6/382012 by LBA).

In any case, air transportation is restricted to cargo aircraft (no passenger aircraft) only. For more details, see actual IATA Lithium battery guidance document.

When exporting the batteries, they are likely to undergo the judgment on classification of strategic products according to the Export Trade Control Ordinance. Please contact SubCtech, we will assist you.

With UN T38.3 certification

This design may be approved according UN T38.3. SubCtech already approved batteries with external labs, and provide a complete certification.

With this certification, the batteries can be transported via air-cargo. The above mentioned documents are still needed, SubCtech is approved to write these documents.

Without UN T38.3 certification

The battery modules can be transported by air cargo via IATA special regulation A88. SubCtech is approved by government (LBA, approval B32F/438.6/382012) to transport the battery modules in single boxes under the A88 regulation. You have to check special regulations for your departure and eventually destination country.



Image 79: SubCtech common approval for air cargo

SubCtech GmbH	Address	Phone	Fax	Mobile	Web
Wellseedamm 1-3	D-24145 KIEL	+49 (0) 431-22039880	+49 (0) 431-22039881	+49 (0) 178-35 21 99 2	www.subtech.com

SubCtech GmbH	phone: +49 (0) 431-22039880	Bank: Foerde Sparkasse
Wellseedamm 1-3 • D-24145 KIEL • Germany	fax: +49 (0) 431-22039881	IBAN: DE92 2105 0170 1400 0559 58
Managing Director: Dipl.-Phys. Stefan Marx	mobile: +49 (0) 178-35 21 99 2	BIC: NOLADE21KIE
Amtsgericht Kiel	email: info@subtech.com	The protection notice ISO 16016 applies to the content of this document.
VAT-Id.No. DE270099549	web: www.subtech.com	

Li-ion batteries must be transported as dangerous goods:

- UN Class 9
- Packing group II
- Li-ion Battery UN number: UN 3480
- Li-ion Battery packed in/with equipment: UN number: UN 3481
- Technical name: Lithium Ion Batteries / packed with equipment /contained in equipment (this name must be used, don't change it!)
- Accident EmS No.: F-A, S-I (IMDG code)
- Explosive: no
- Dangerous for the marine environment: no

The batteries must be transported according to the special regulation SV310 for prototype testing only. The supplied Aluminum box is suitable for all kinds of transports and comply with the standards of ADR/IMGD/IATA 2017.



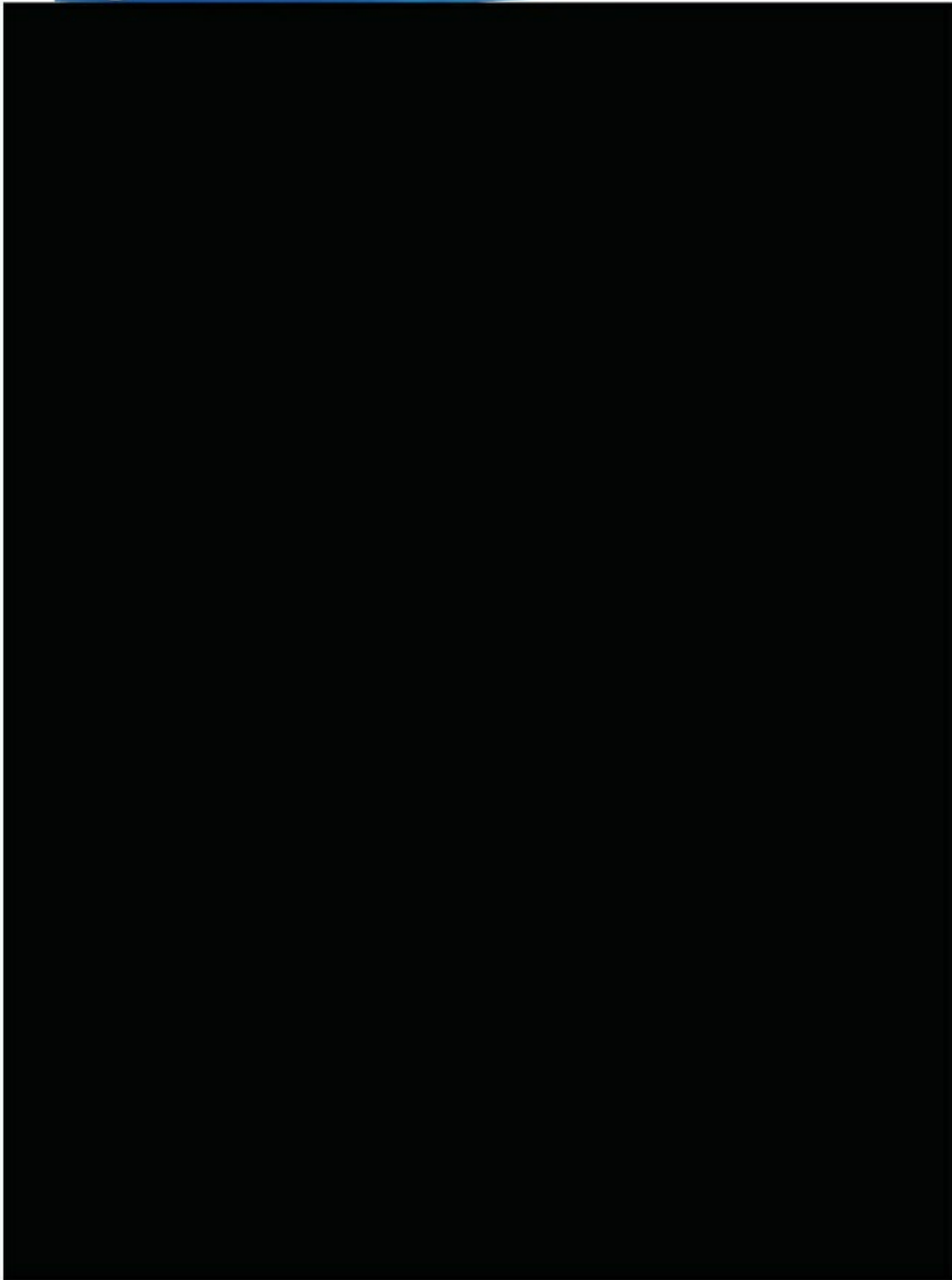
- When exporting the batteries, they are likely to undergo the judgment on classification of strategic products according to the Export Trade Control Ordinance.
- SubCtech is registered as a vendor of batteries. We are pleased to advise you regarding the transport regulations for Li-ion batteries.

- Do not transport when switched on or connected!
- When relocating the equipment use of the original packing is recommended
- Use suitable safety clothing, especially safety shoes, when carrying the equipment, as due to its weight a fall can have serious consequences
- The goods must be packed properly and fully protected against the detrimental effects of moisture, salt, dust, vibration & shock and temperature which the material may subject to during shipment and transportation.
- The temperature during transportation or storage should not exceed +35°C for a longer period of time (approx. ~days). Short temperature up to +60°C is permitted.
- The transportation must follow the EC normative and standards about Lithium transportation: UN 3480 Class 9. Please follow the special and actual regulations.

SubCtech GmbH
Wellseedamm 1-3 • D-24145 KIEL • Germany
Managing Director: Dipl.-Phys. Stefan Marx
Amtsgericht Kiel HRB 11552 KI
VAT-Id.No. DE270099549

phone: +49 (0) 431-22039880
fax: +49 (0) 431-22039881
mobile: +49 (0) 178-35 21 99 2
email: info@subctech.com
web: www.subctech.com

Bank: Foerde Sparkasse
IBAN: DE92 2105 0170 1400 0559 58
BIC: NOLADE21KIE
The protection notice ISO 16016 applies to the content of this document.



4.21.9 Storage

Store the battery in a cool dry place separately from anything hazardous, such as explosives, combustibles, or any other highly flammable material. It is recommended to store the battery in a room with a fire alarm and water-based automatic sprinkler system installed.



Batteries are categorized as dangerous goods class 9. The joint storage with dangerous goods of the following classes is prohibited:

Class 1, Class 1.4, Class 1.5, Class 1.6, Class 4.1, Class 5.2

The battery needs to be long-term stored with a voltage between min. 30% SOC and max. 80% SOC (not critical) and at a temperature range between best +5°C and +20°C.

Max. storage temperatures ratings:

-20 ... +60 °C, 1 month

-20 ... +45 °C, 3 months

-20 ... +25 °C, cont.

While stored for a longer period of time the battery must be recharged (every 3 month) in order to guarantee a long-life time and low capacity lost.

The saved data from the SD-Card should be removed every 3 years of operation.

Your responsibility after usage and for storage:



Never store fully discharged

Charge directly after deployment.

Never store fully charged

Charge directly before deployment

Check regularly

4.21.10 Reactivation of the Battery

After a storage period of more than one month the battery needs to be completely charged and balanced before operation to achieve maximum capacity.

4.21.11 Maintenance

4.21.11.1 Maintenance by the Customer

No regular maintenance, other than regularly recharging the battery during storage is required in order to ensure a long-life time of the battery.

No parts need to be exchanged on a regular basis.

4.21.11.2 Maintenance by the Manufacturer

A standard maintenance procedure means the following will be replaced and/or maintained by the SubCtech technical department:

- Change of battery pack, if required
- Change of tripped fuses, if required
- Software update, if required
- Test-run of "burn in" charge-discharge cycle with certificate

No further maintenance is needed.

4.21.12 Disposal

SubCtech is registered manufacturer of industrial batteries. The EU directive on batteries from 2009 (EC directive 2006/66/EG), ElektroG and WEEE means producers must pay for the collection, treatment and recycling of batteries, unless the person operating the piece of equipment or another, delegated person is conducting the disposal. Our equipment falls under these regulations and is accordingly marked with the following symbol below.

SubCtech is member of the "Melderegister des Umweltbundesamt nach BattG", Register no. 1002655

To fulfil these requirements SubCtech or your dealer is responsible for the redemption and correct disposal of all delivered batteries inside the EU. Please contact SubCtech or your dealer at the end of life of your product.

SubCtech GmbH
Wellseedamm 1-3 • D-24145 KIEL • Germany
Managing Director: Dipl.-Phys. Stefan Marx
Amtsgericht Kiel HRB 11552 KI
VAT-Id.No. DE270099549

phone: +49 (0) 431-22039880
fax: +49 (0) 431-22039881
mobile: +49 (0) 178-35 21 99 2
email: info@subctech.com
web : www.subctech.com

Bank: Foerde Sparkasse
IBAN: DE92 2105 0170 1400 0559 58
BIC: NOLADE21KIE
The protection notice ISO 16016 applies
to the content of this document.

5 Specification HMI battery

This special designed subsea PowerPack™ is suitable to operate under rough offshore conditions and long lifetime. The design was optimized for highest performance, highest safety and highest reliability.

Our batteries have low capacity loss over time as well as high usable energy over a wide state of charge (SOC) range, allowing our systems to meet end-of-life power and energy requirements with minimal pack oversizing. This type of battery and BMS with charger was already successfully used in a number of subsea & vehicle applications.

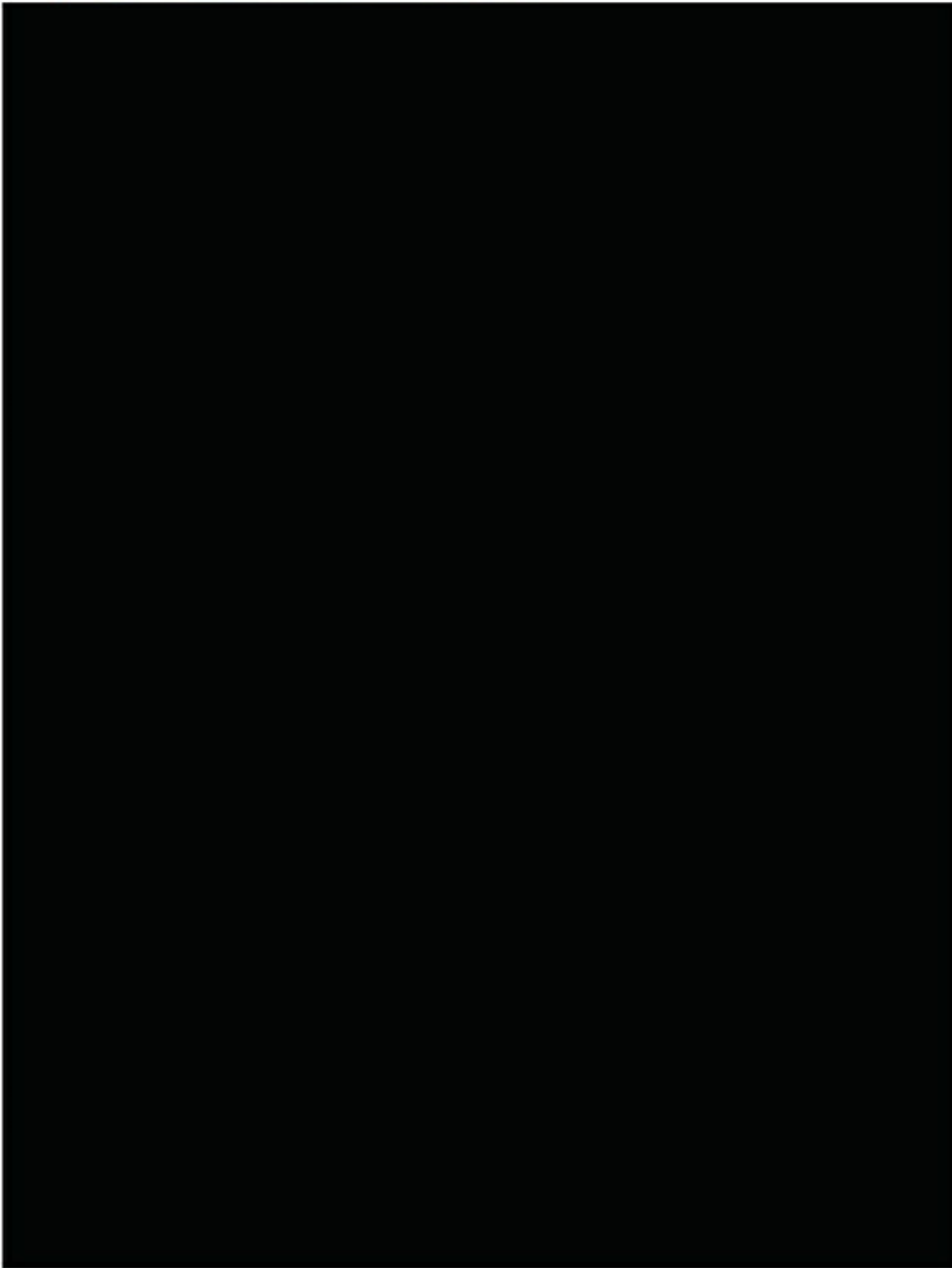
The battery pack construction in this project is a customized COTS on a high TRL level, and therefore on highest safety and reliability level.

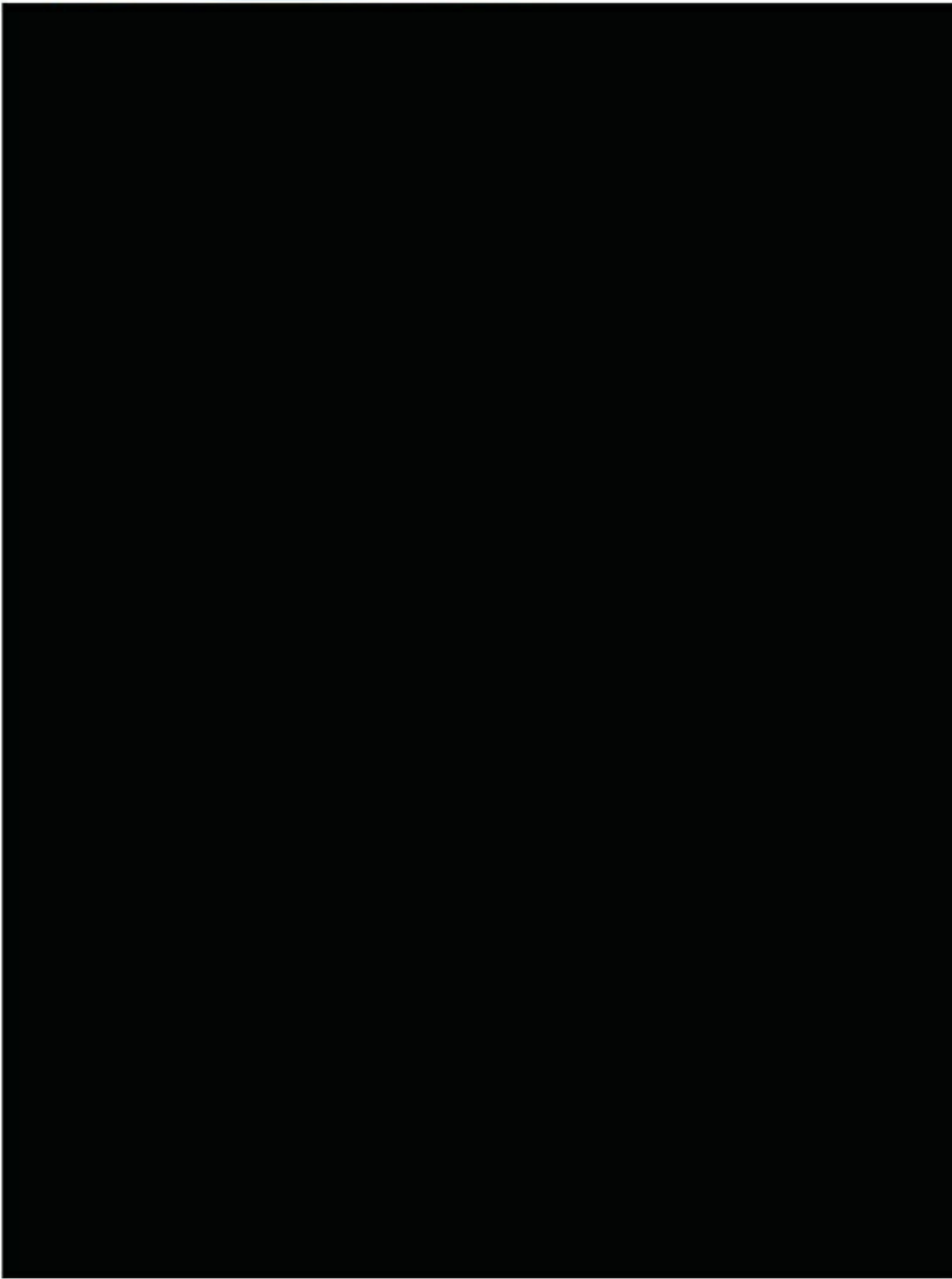
The battery must be charged externally with its own so called PowerCharger™, because the charger is under control of the battery BMS-master and part of the SmartBMS™, to protect the battery and persons in any situation. This feature is already accepted by DNV-GL during our technology conferences OBD in Oslo. Many enhanced features are included to minimize aging and extend lifetime, in opposite to commercial COTS charger.

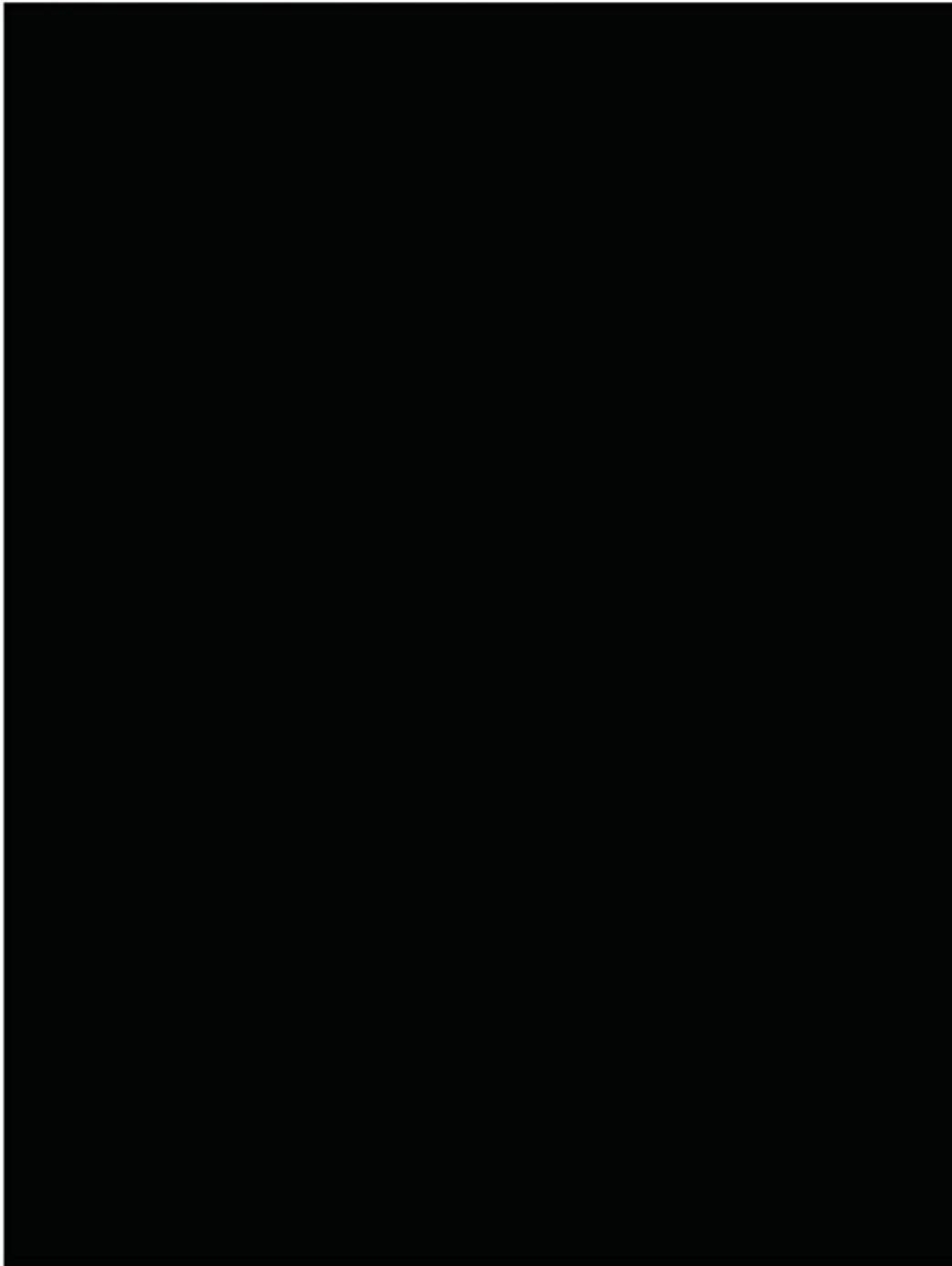


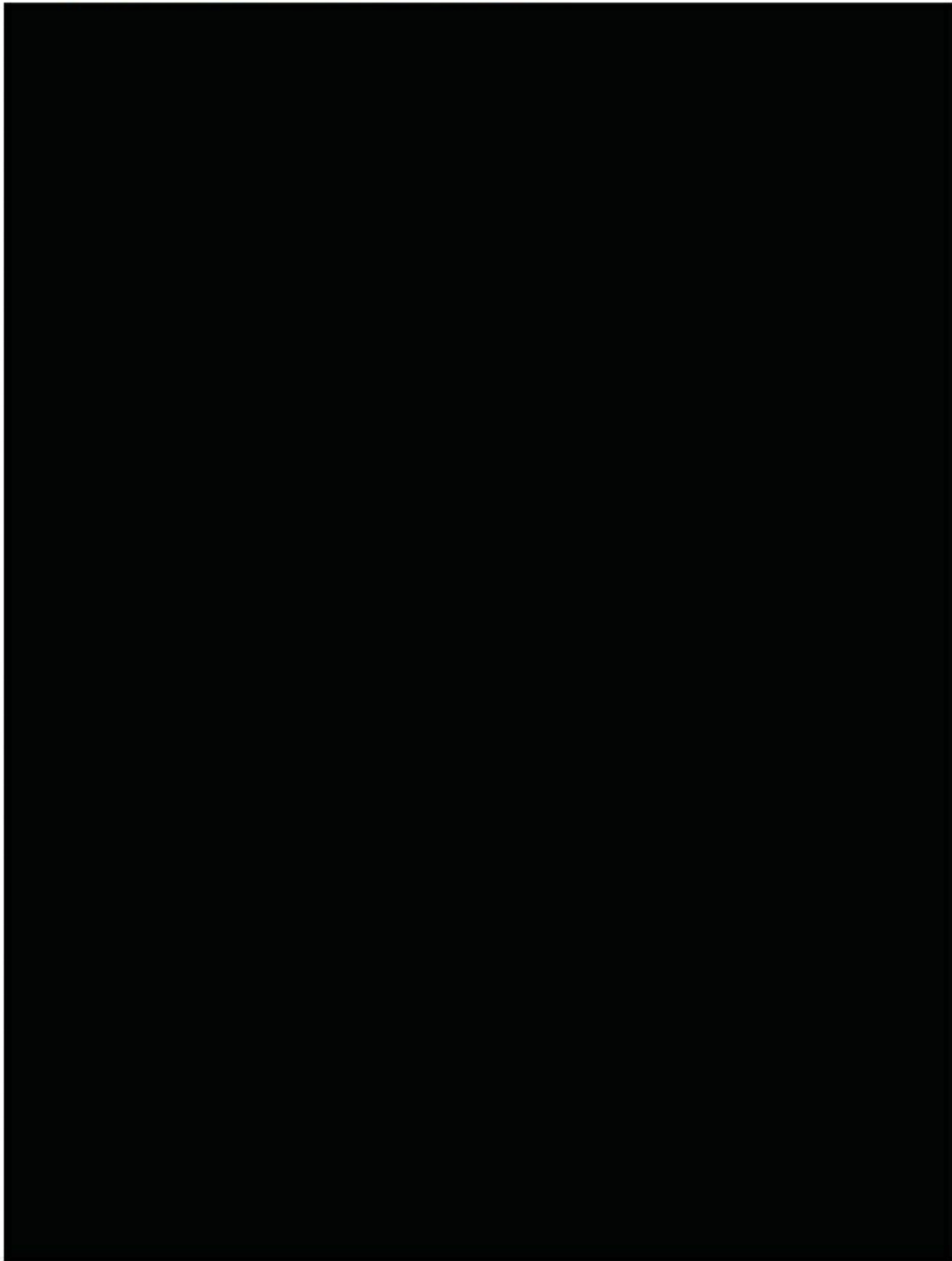
Image 82: Photo of HMI Aquanaut battery and a typical series 416 battery with 5 SPB (here under production)

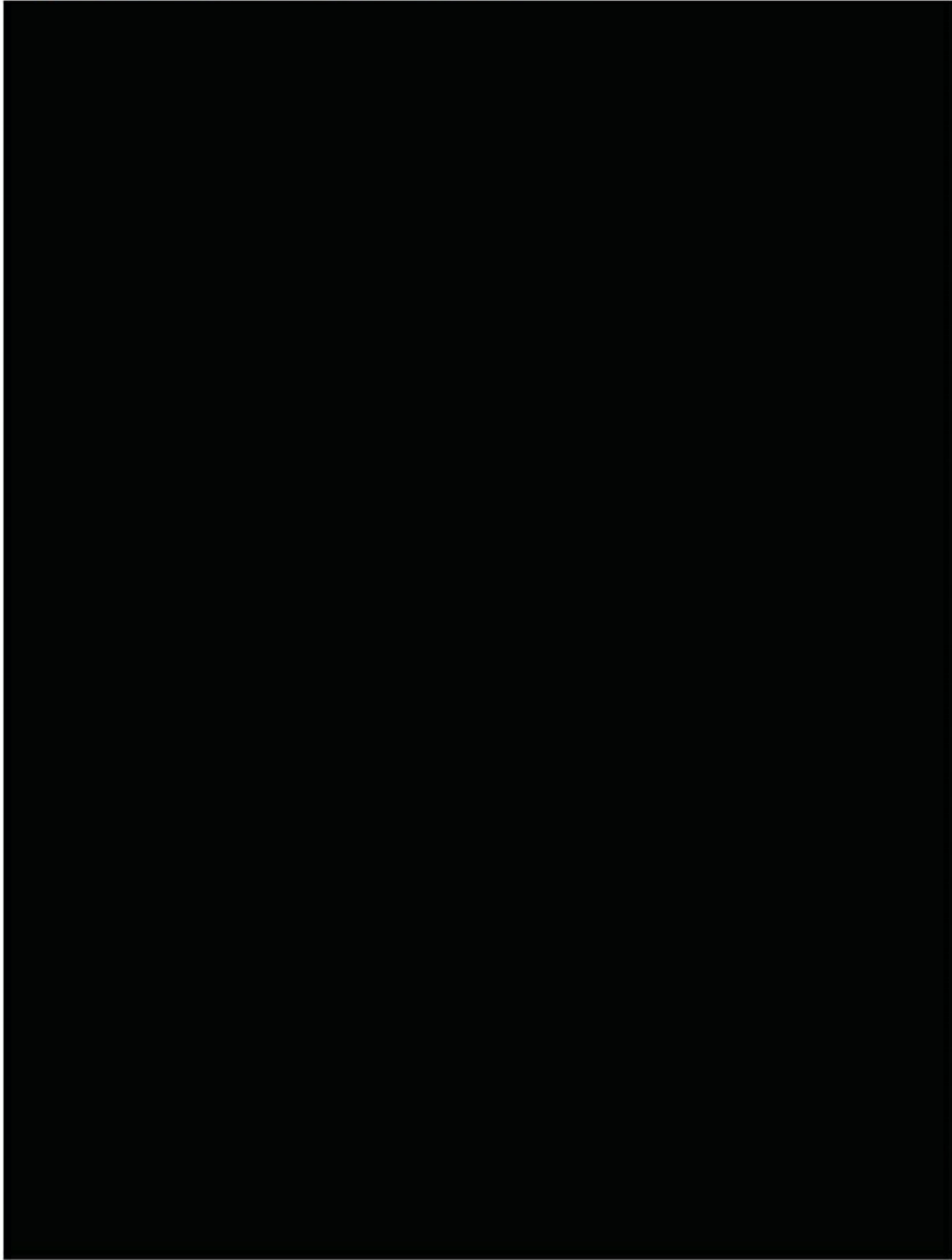
The batteries are always built with two channels, i.e. they are always redundant internally. It must then be calculated if a single channel can handle the full load.

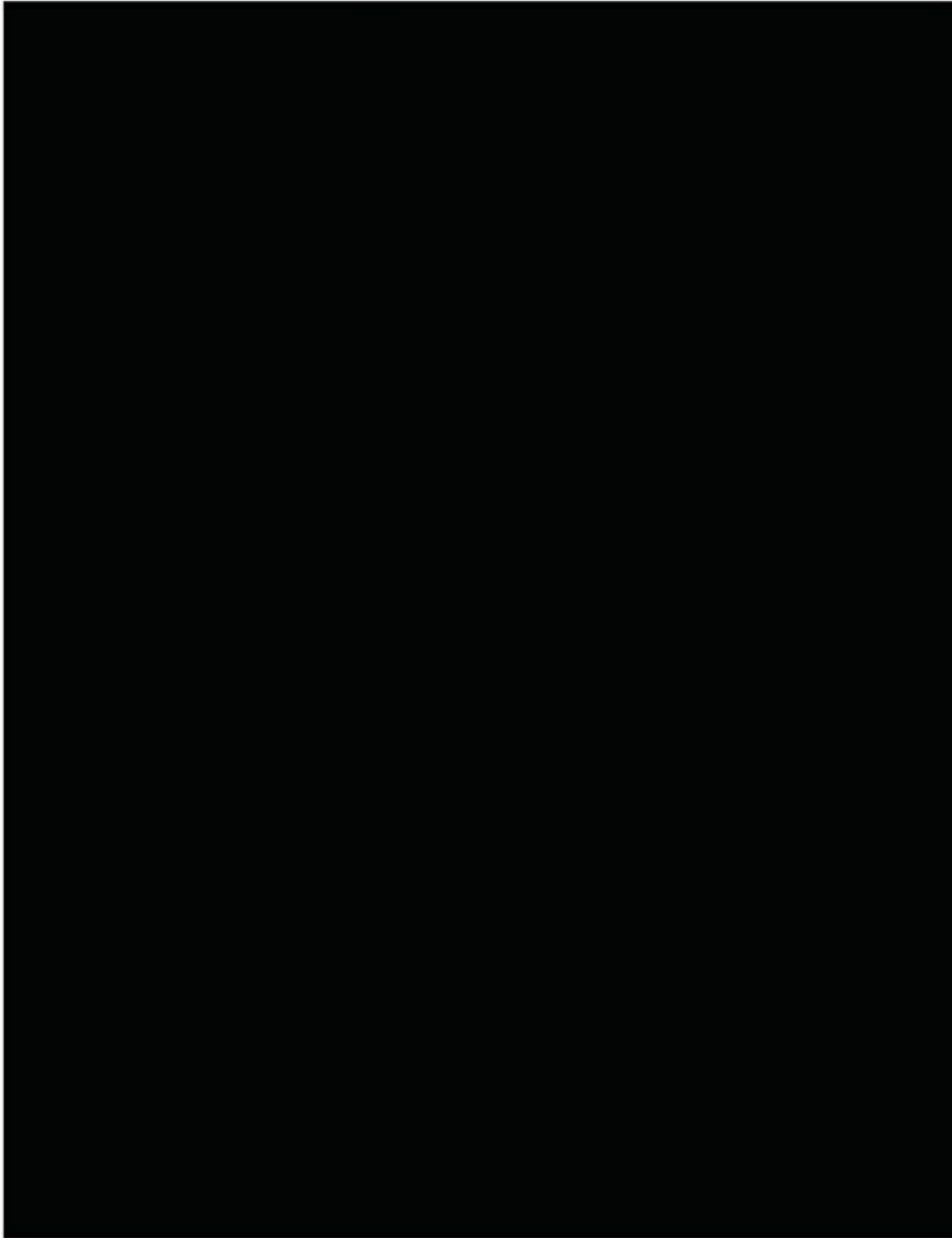


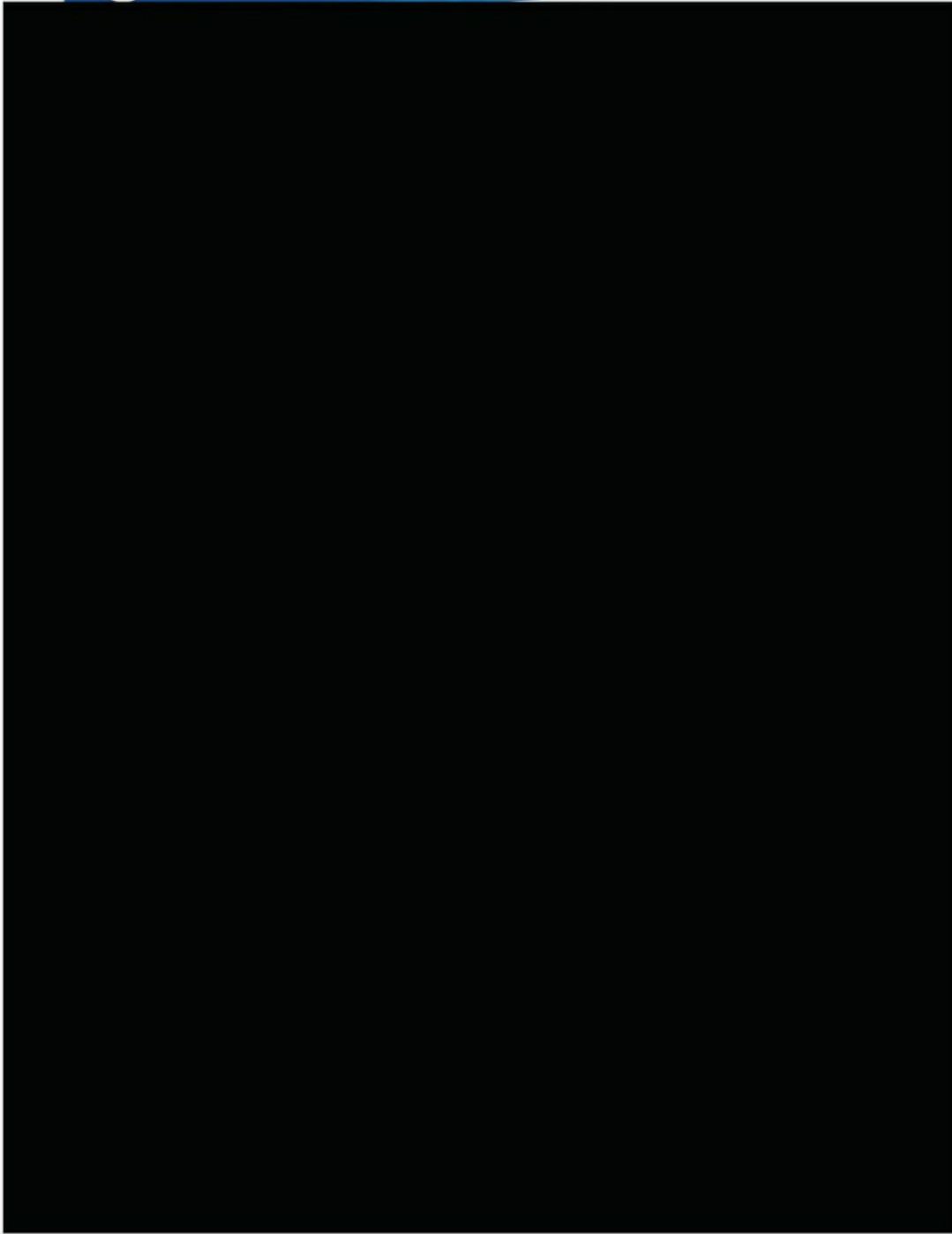


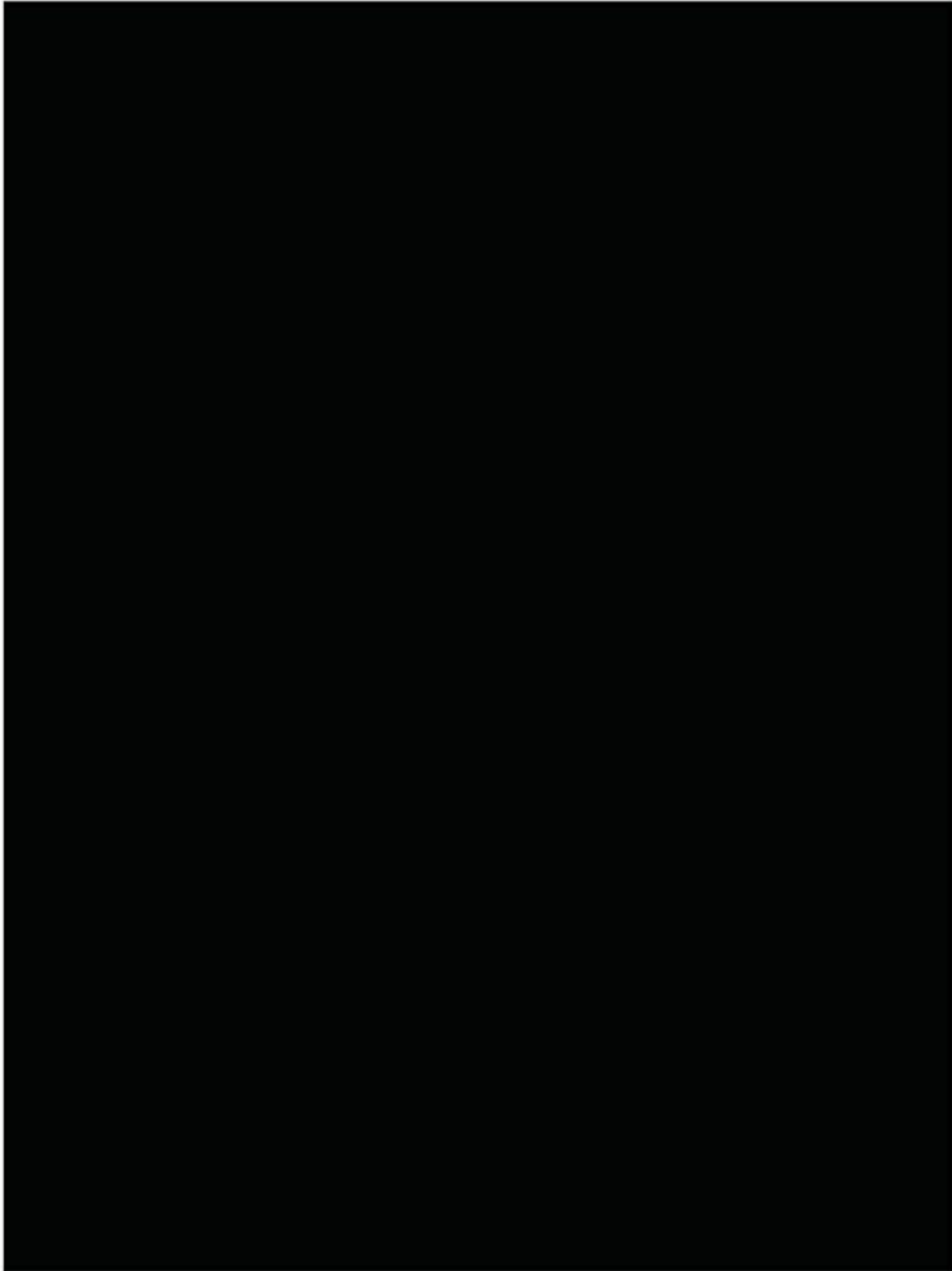


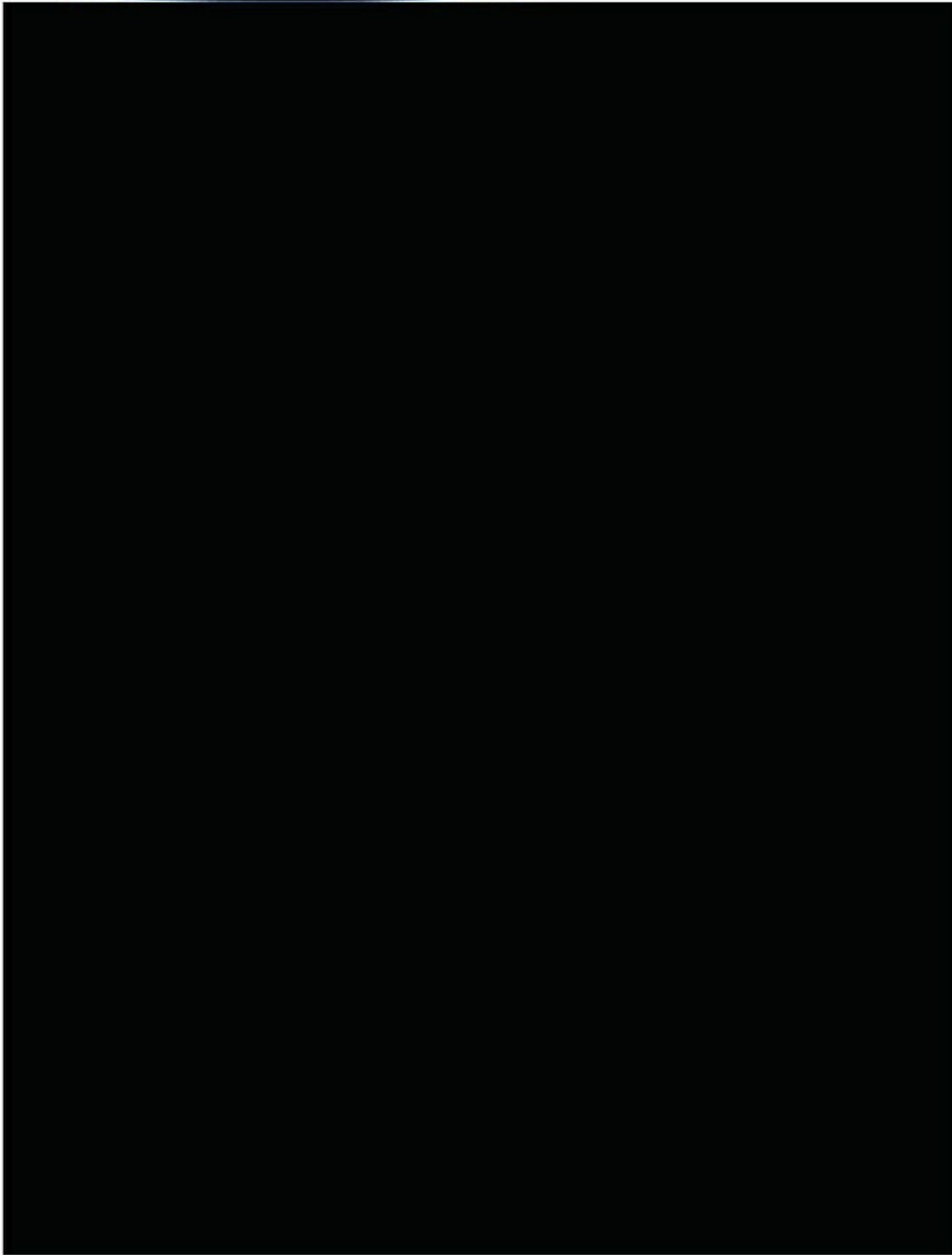


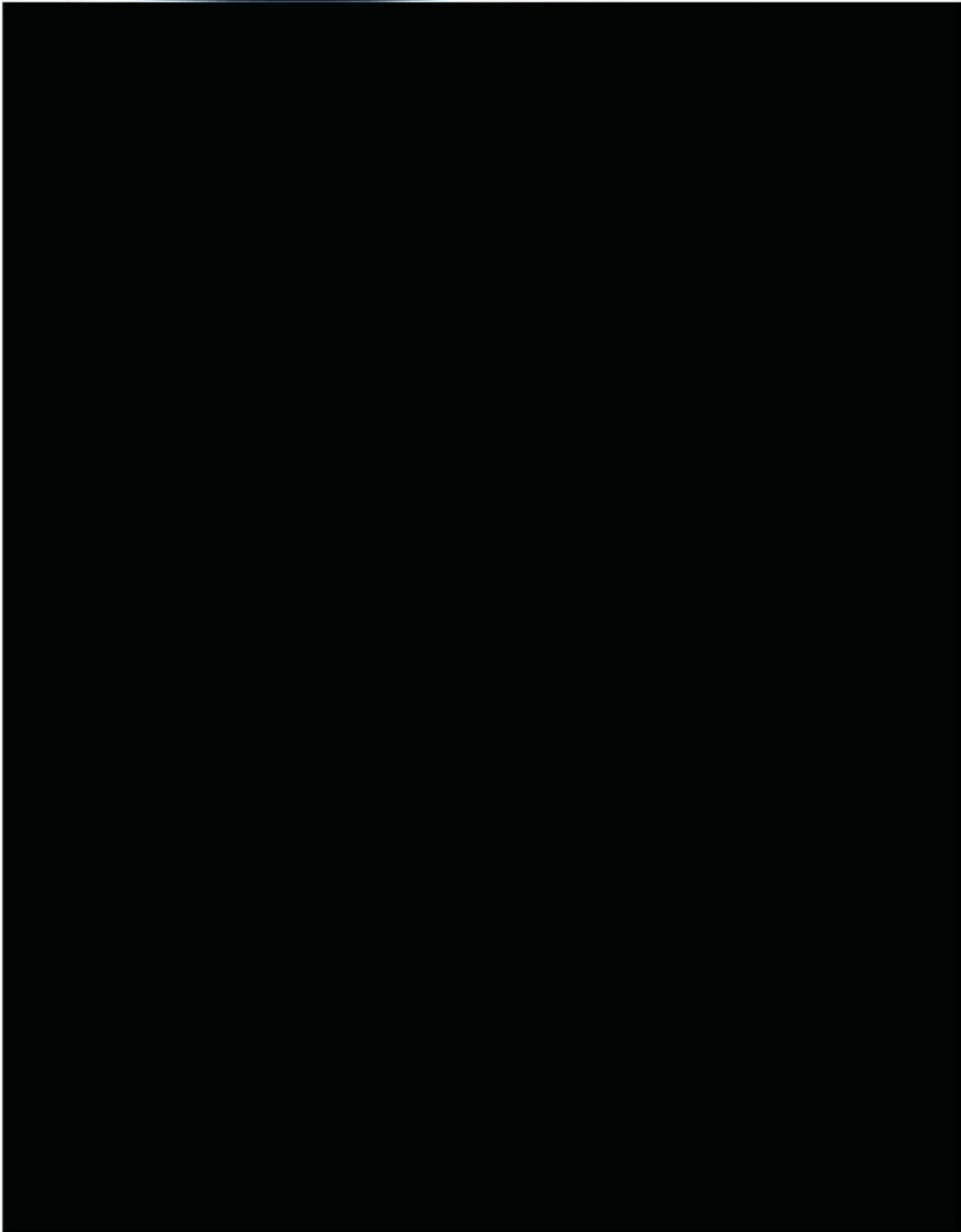












5.8 Cycle and calendar life

Cell manufacturers do not publish any particular performance data. Indeed, the use of the cell is well known and a large number of publications and literature exist.

Normally, Li-Ion cells are always specified with a cycle number of 300 to 500. The calendar life span is difficult to pin down and depends on many conditions. The type of use is essential: heating and long storage periods fully charged or fully discharged reduce the service life, including the cycles, considerably.

By lowering the maximum charge voltage and the minimum discharge voltage, the critical area of the higher internal resistance is masked out. This measure minimizes aging and significantly increases the number of cycles. We can assume a possible number of cycles of 3000.

According to our experience since 2006, the service life (battery calendar life) is more than 10 years. This also emerges from the discussion about the second life. The aging is normally less than specified - provided that it is handled according to the instructions.

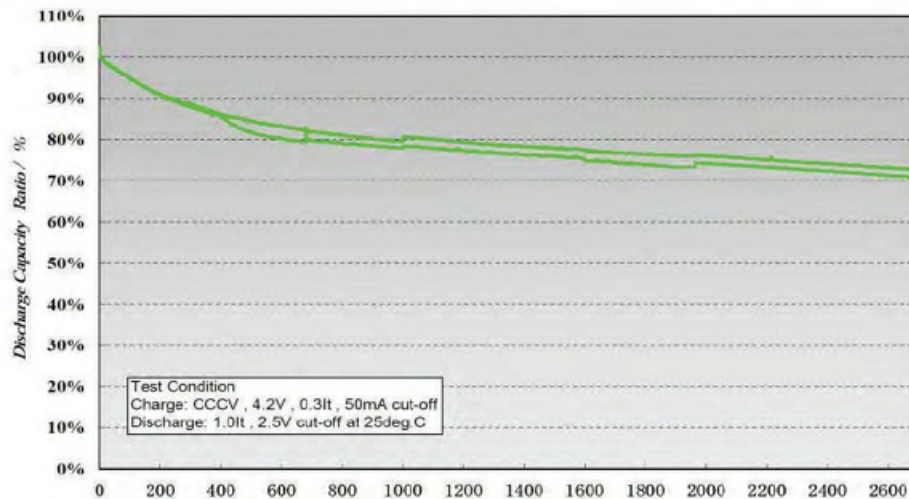


Image 90: Cycle life time test of 2 cells (cell producer internal document)

Lifetime is typ. defined as cycle number until the capacity is 80% of the rated capacity, for this cell already 800 cycles. The battery is still usable up to 2600 cycles with 70% capacity of the rated capacity, if the recommended charging and handling procedures are fulfilled.

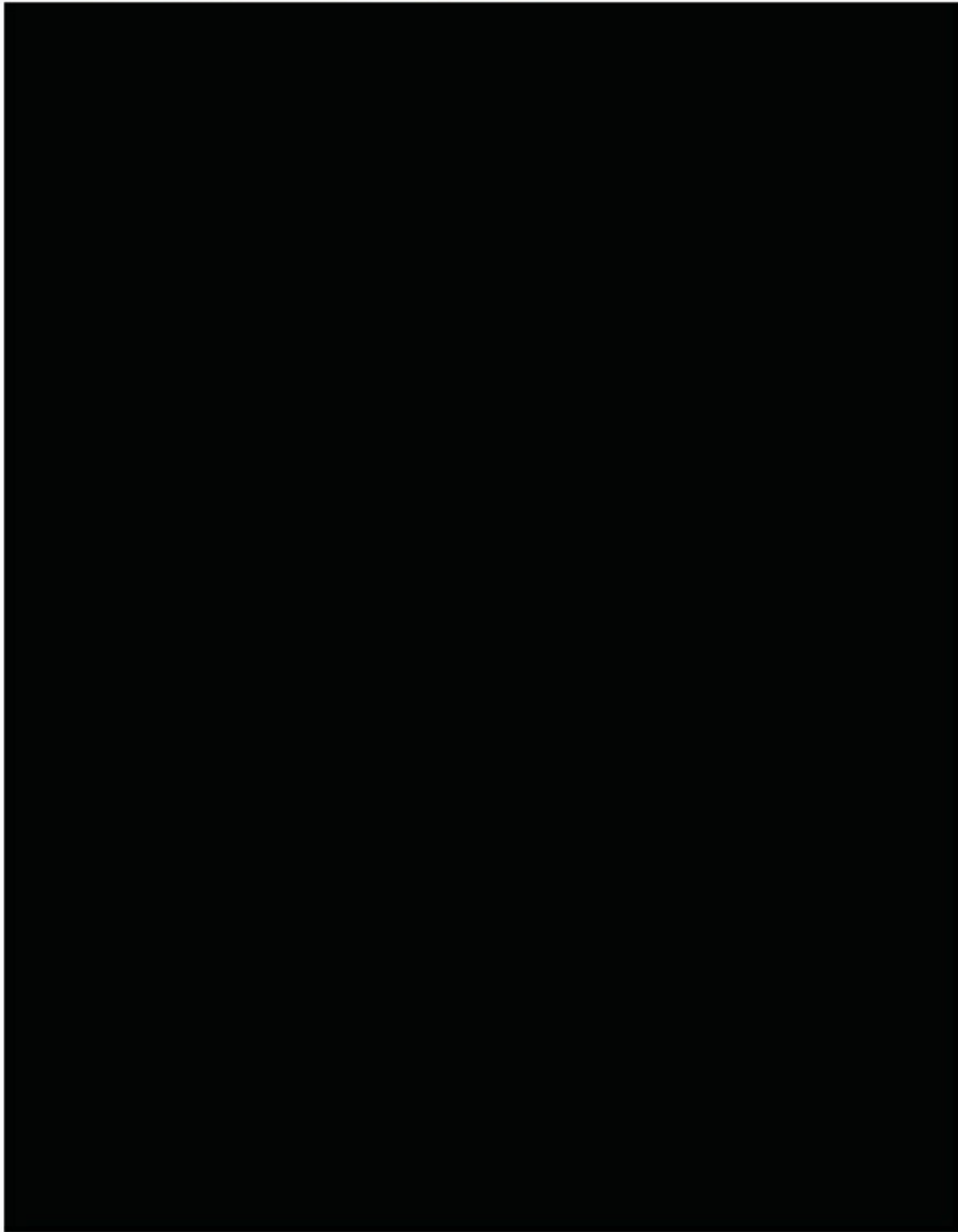
Longer usage is not recommended due to aging and possible fatal failures or fire.

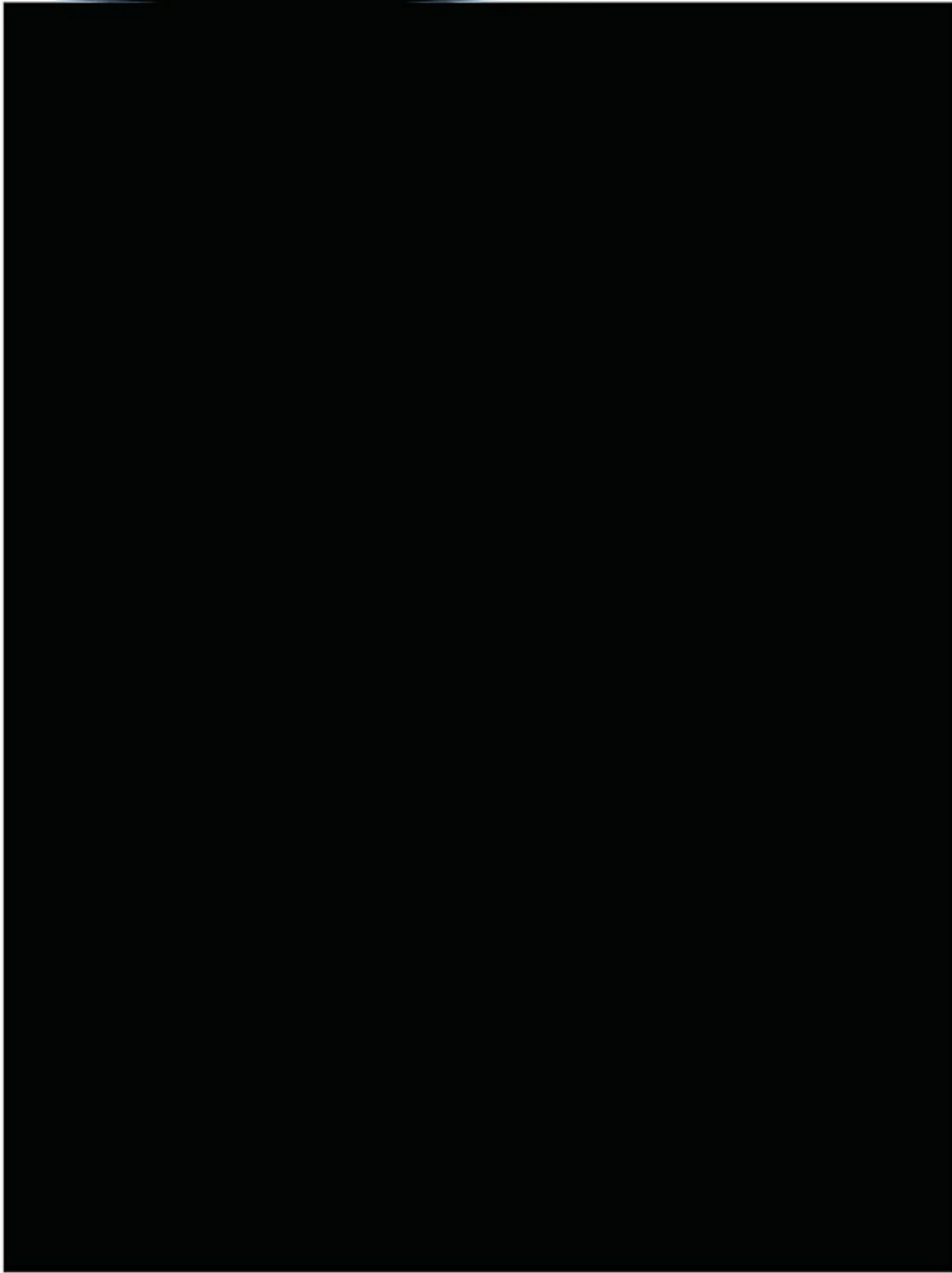
Note: for this test a high load of 1C was used. For large batteries such as AUV batteries the load is typ. 0.1C to max. 0.5C.

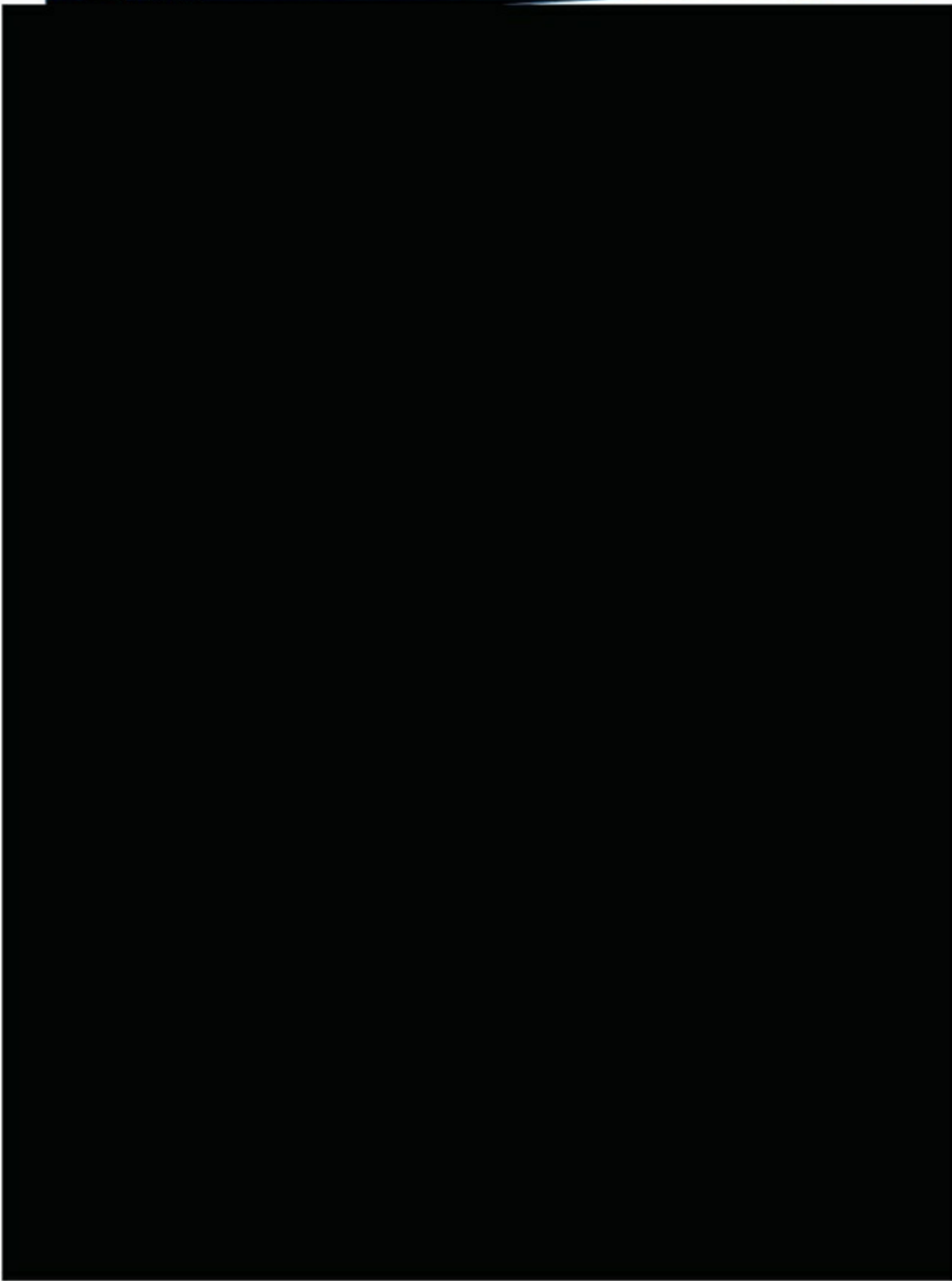
SubCtech GmbH
Wellseedamm 1-3 • D-24145 KIEL • Germany
Managing Director: Dipl.-Phys. Stefan Marx
Amtsgericht Kiel HRB 11552 KI
VAT-Id.No. DE270099549

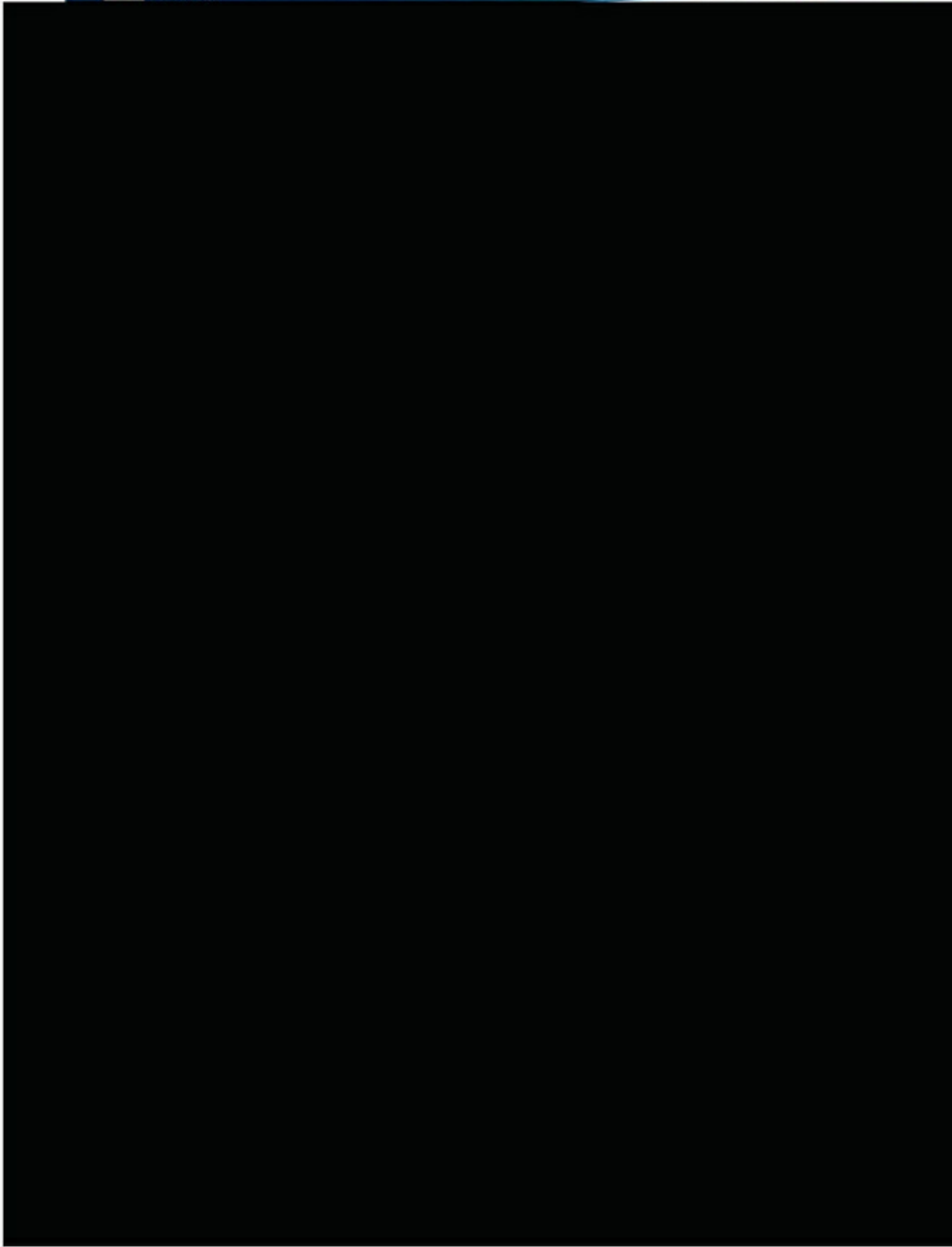
phone: +49 (0) 431-22039880
fax: +49 (0) 431-22039881
mobile: +49 (0) 178-35 21 99 2
email: info@subctech.com
web: www.subctech.com

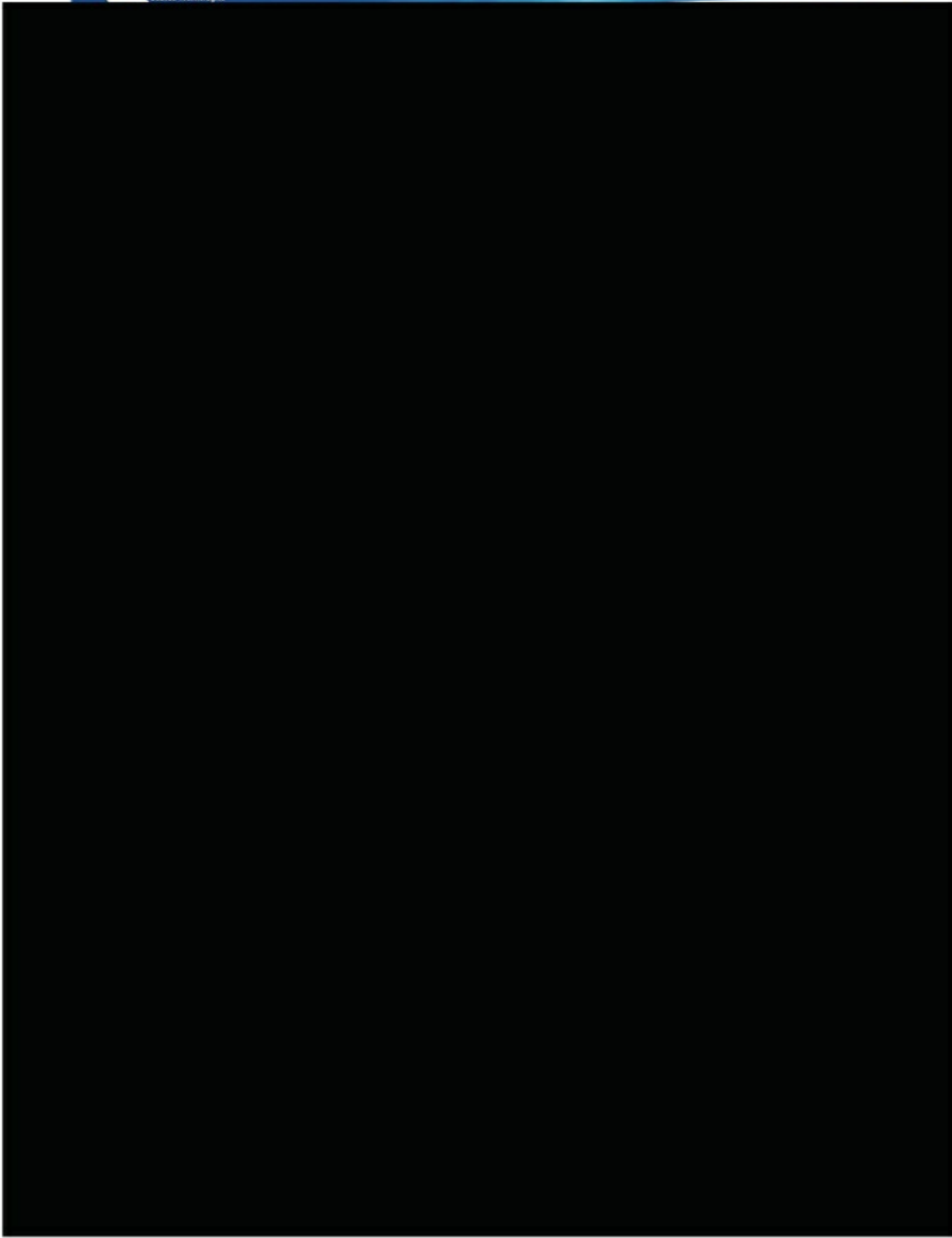
Bank: Foerde Sparkasse
IBAN: DE92 2105 0170 1400 0559 58
BIC: NOLADE21KIE
The protection notice ISO 16016 applies to the content of this document.

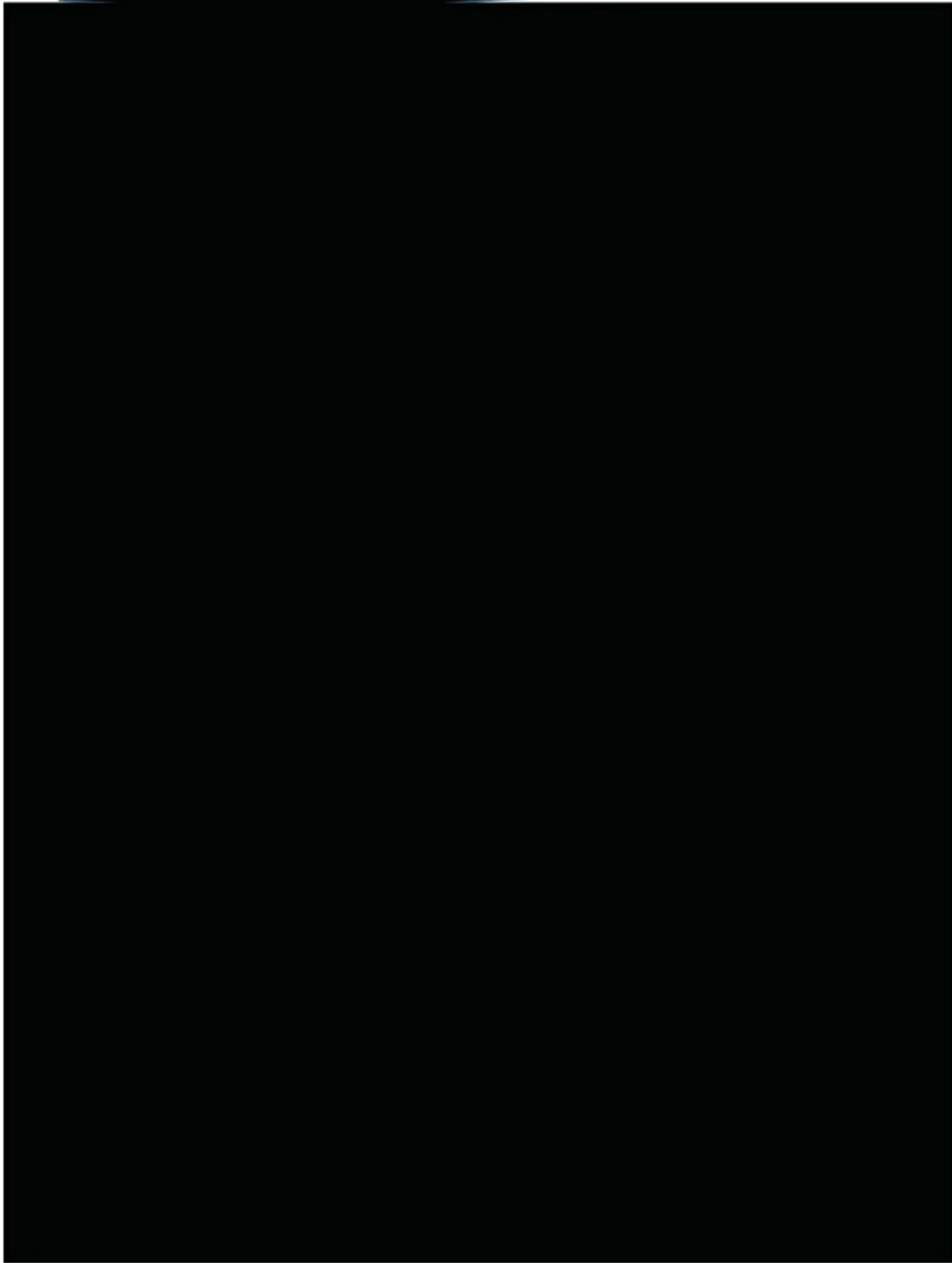


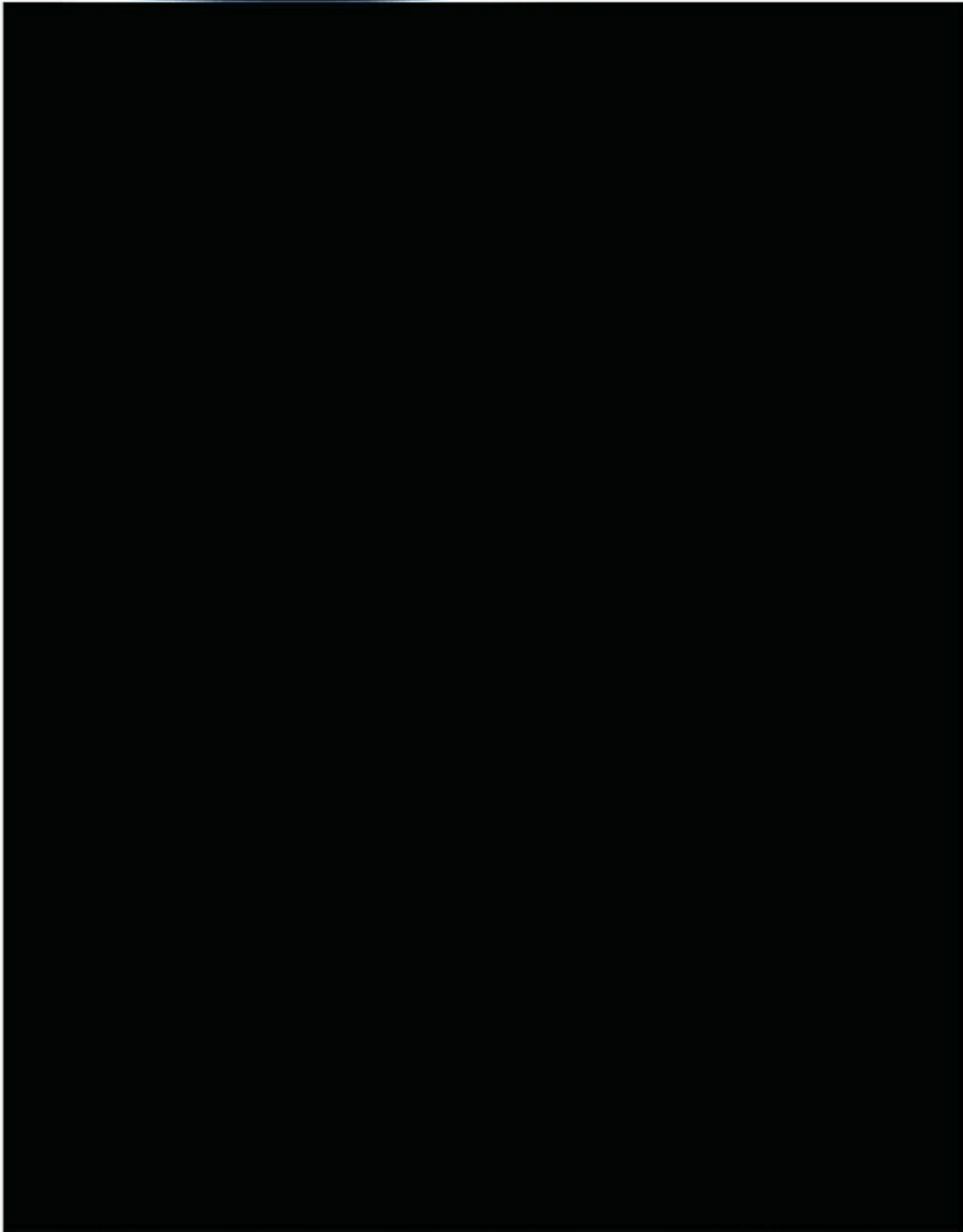


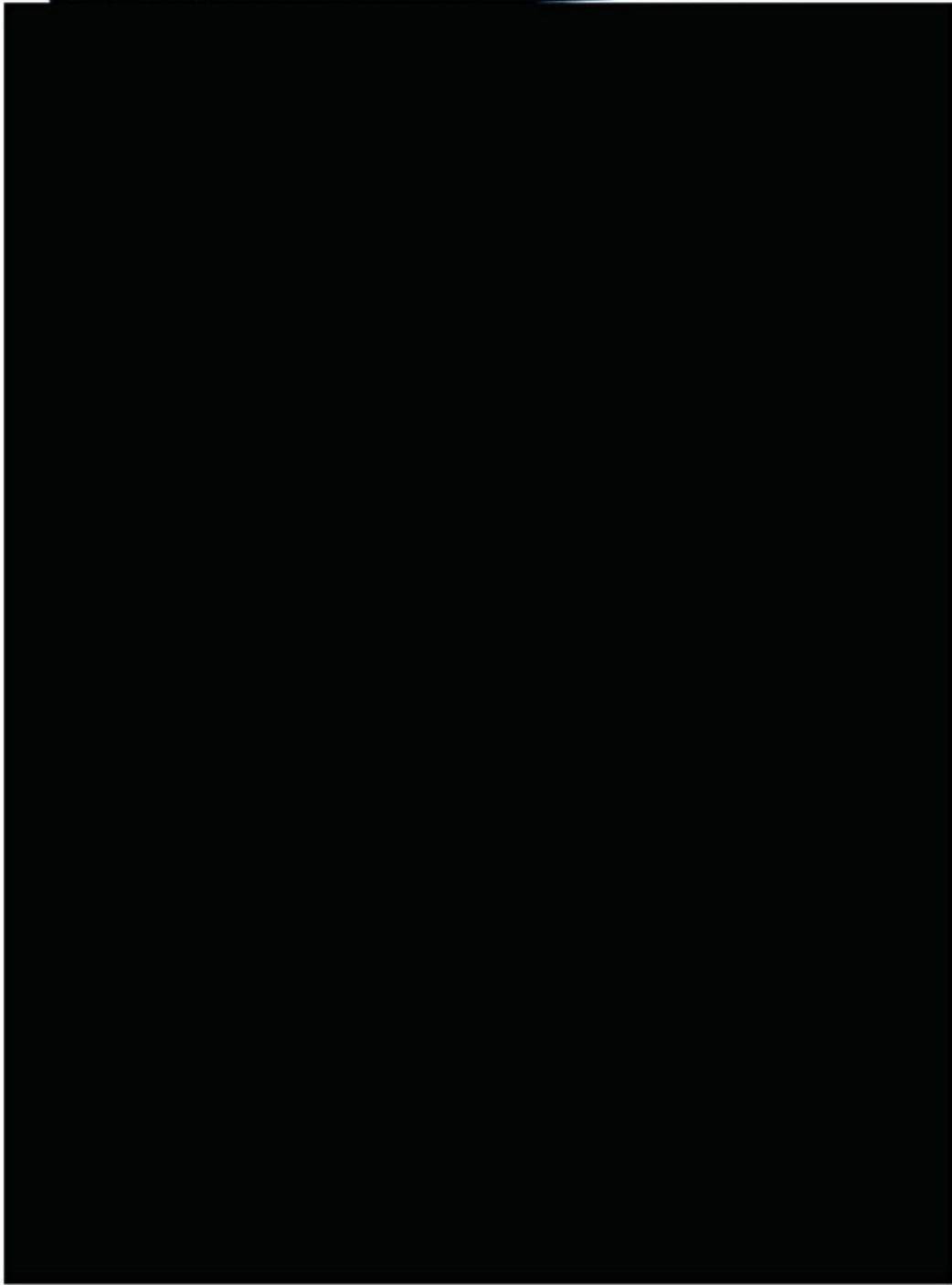


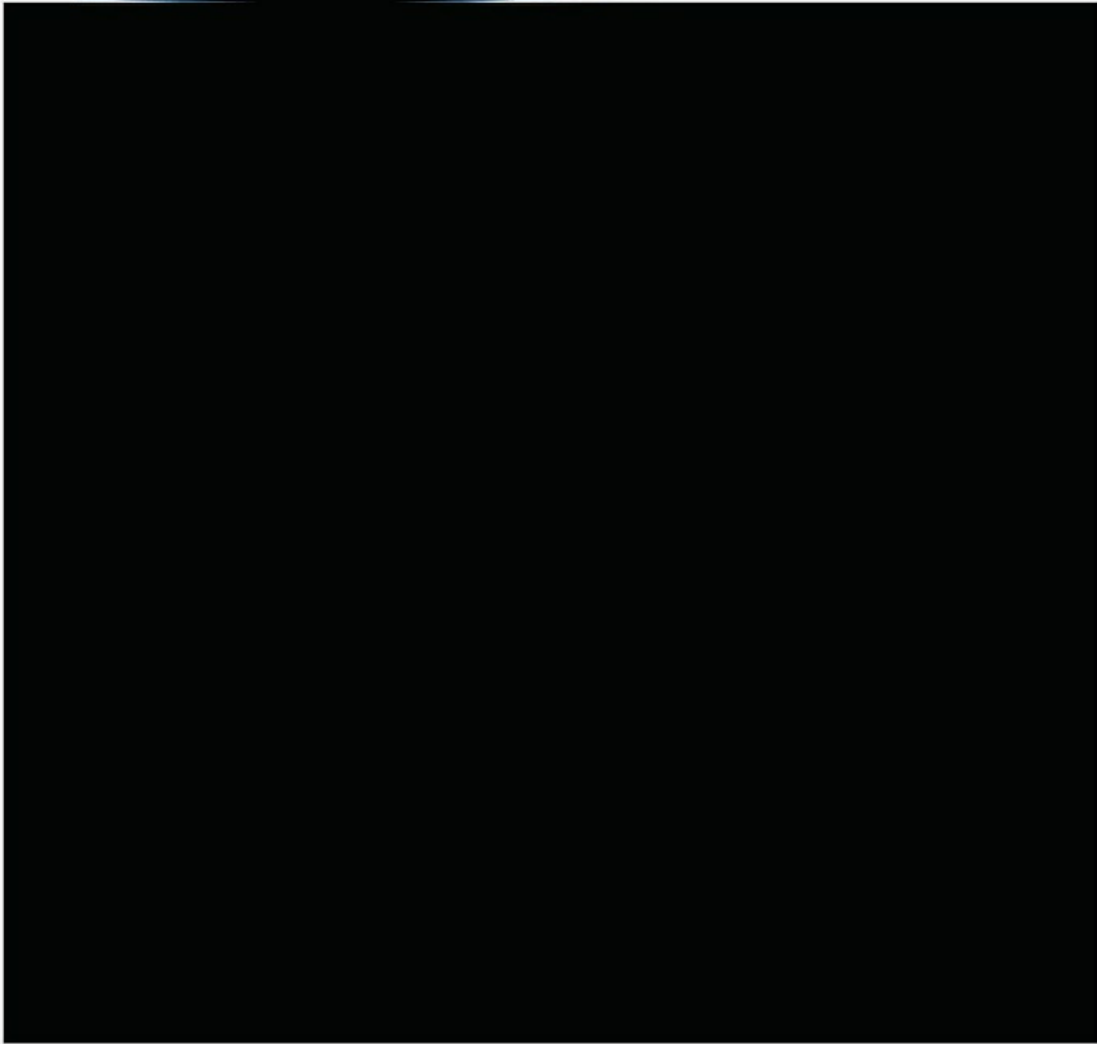


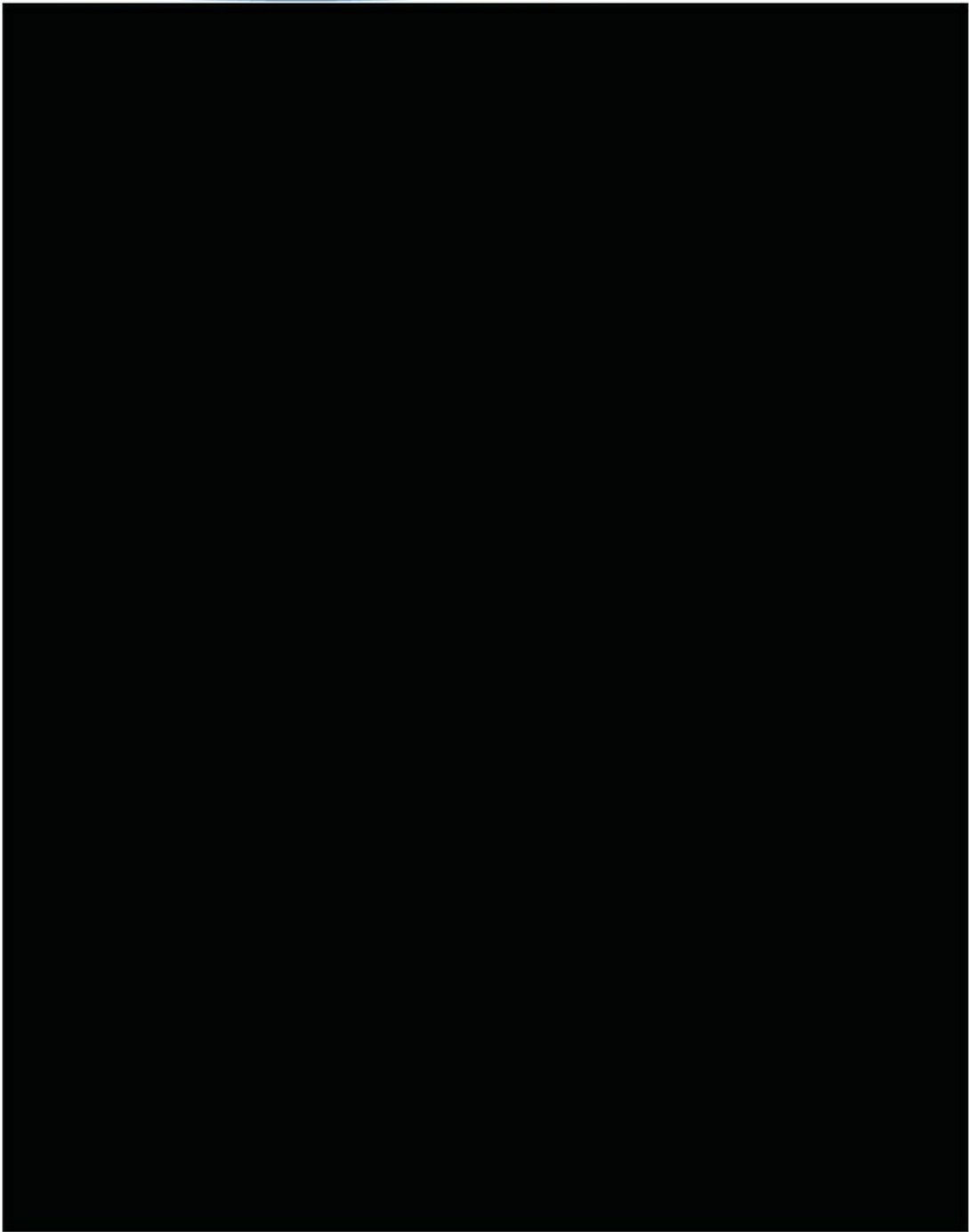


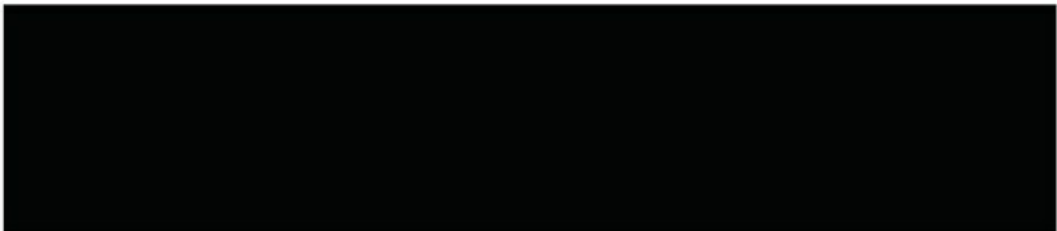
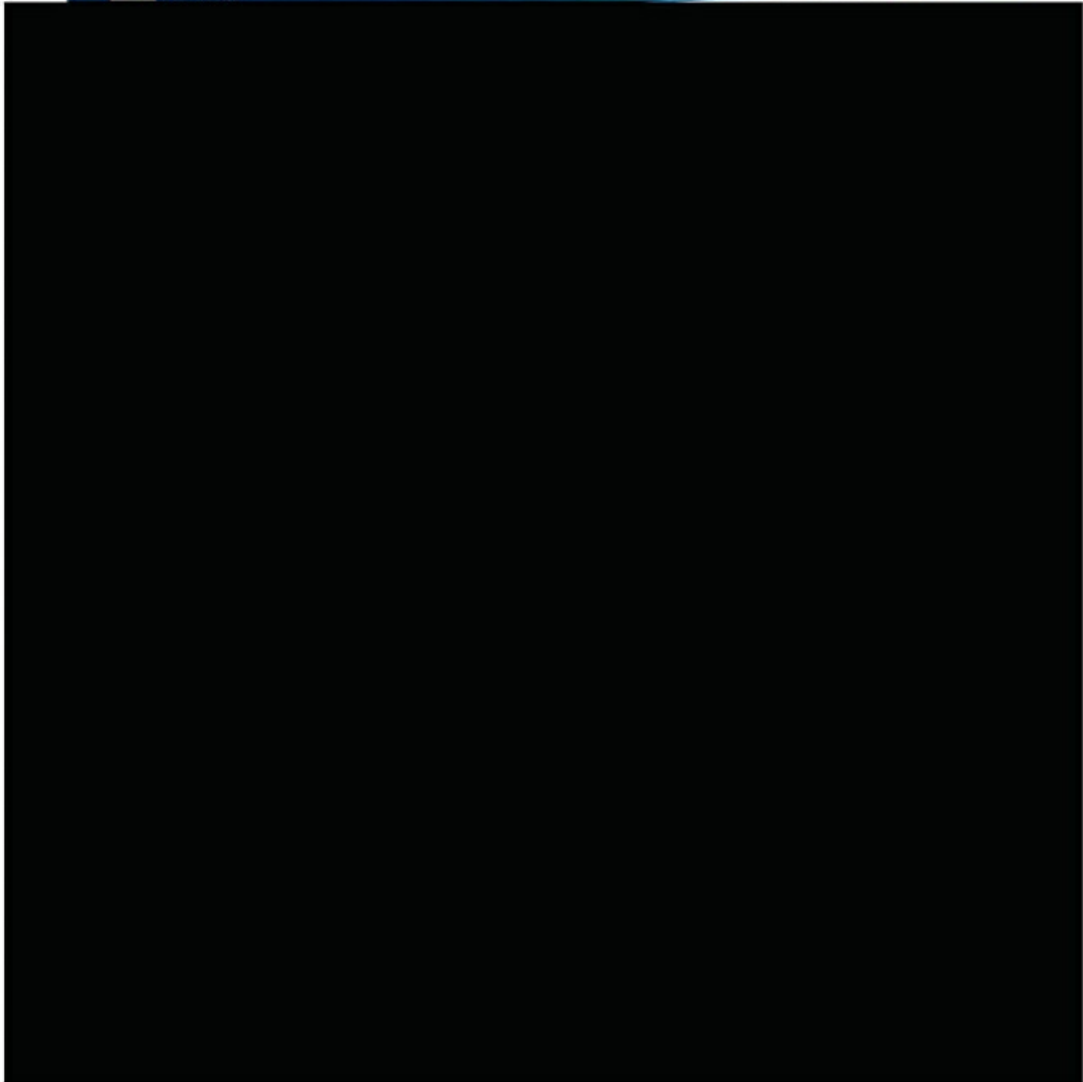


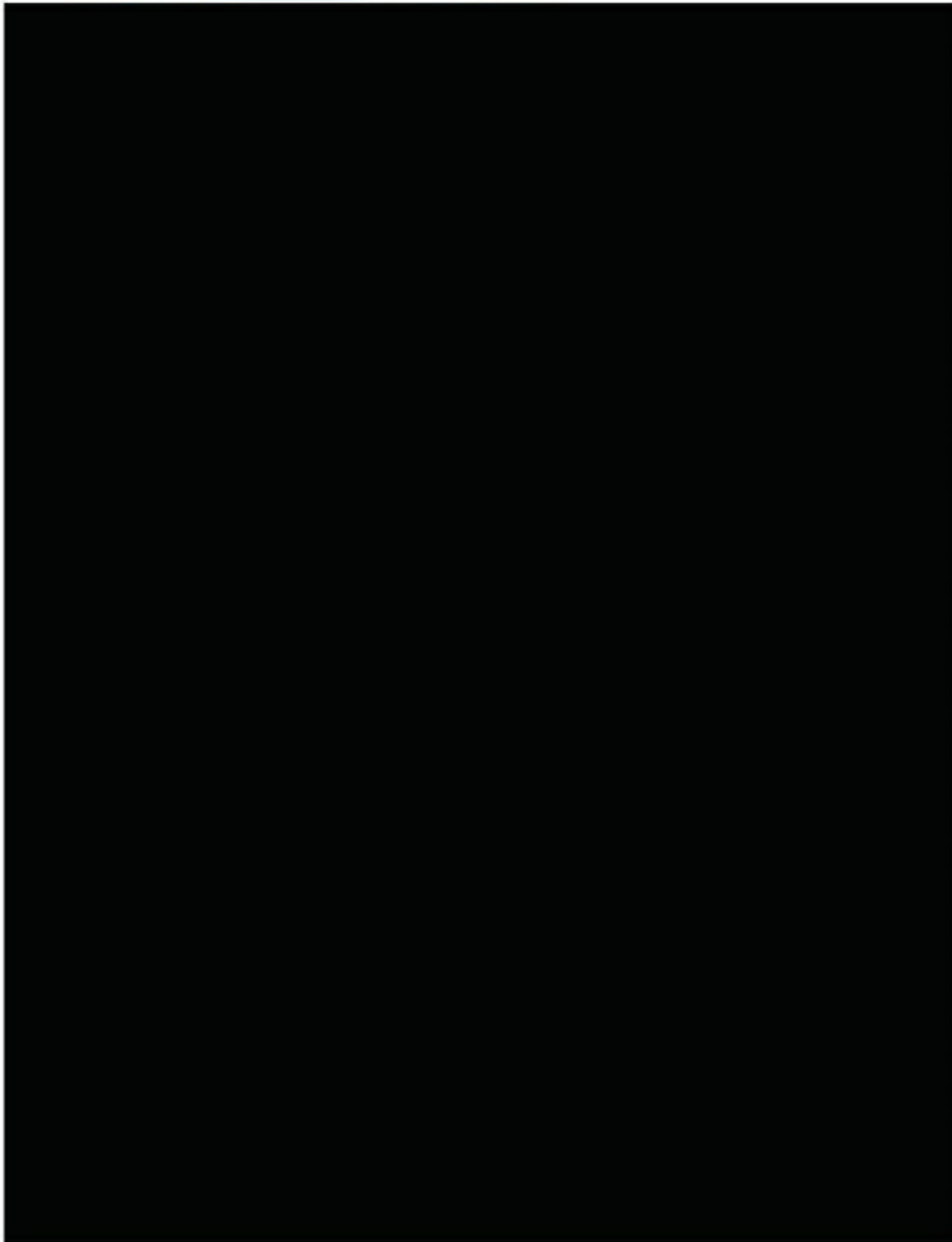












6 Quotation


6.1 Quotation: Battery system - 5 modules – 35 kWh





Art.	Image	Component	Unit price EURO	QTY	Total Price EURO
1-22xx /35kWh /162V /A	 <p>Photo comparable</p>	<p>Li-Ion Series 416 - 162V – 35kWh</p> <p>High-Performance Li-Ion battery. All parameters as specified for the series, core parameters are:</p> <p>Output: direct battery output Switchable using the PDU unit</p> <p>Nominal Voltage: 162 VDC battery</p> <p>Voltage range: 130 VDC ... 185 VDC (V_min ... V_max)</p> <p>Nominal Energy: 35.8 kWh</p> <p>Available Energy: 33.7 kWh</p> <p>Power: 20 kW max. cont.</p> <p>Current: 150 A max. cont. @V_min 200 A peak 10s @V_min TBD</p> <p>Interface: MODBUS RTU (CAN via CIM)</p> <p>Size: Ø416 mm x 850 mm length (approx.)</p> <p>Weight: 168 kg in air, without pressure housing Without electronic (PDU, CIM, DC/DC)</p> <p>Operating temp.: -20 ... +60 °C (cell temp.)</p> <p>Charge temp.: +0 ... +45 °C (cell temp.)</p> <p>Storage: -20 ... +50°C (recommended: +5 ... +20°C) 50..80% SOC, recharge 3...6 months</p> <p><i>Including:</i></p> <ul style="list-style-type: none"> - Gliders and mounting blocks/Stopper blocks for rail mounting <p><i>Not including:</i></p> <ul style="list-style-type: none"> - PDU, CIM - Pressure housing - Underwater cables or connectors - NRE or qualifications - Other components as here mentioned 	82.150,00€	2	164.300,00 €
1-6720	 <p>Customized CIM controller to merge data interfaces Photo comparable</p>	<p>CIM control unit</p> <p>The "Customer Interface Module" (CIM) contain various functions. Several batteries can be interconnected here.</p> <p>The individual BMS interfaces of the battery modules are linked and various data outputs are available. These can be made available exclusively to the higher-level system (vehicle CPU), a diagnostic unit or external charger. There are several interface protocols such as serial RS-232, RS-485 NMEA-0183, MODBUS RTU or CAN / CANopen available.</p> <p>The power outputs can be equipped with PDU (Power Distribution Unit) channels. This means that each output is individually switchable and individually protected. Currents, voltages and temperatures as well as short circuits are recorded. External short circuits or an interchanged connection are protected by optional fuses.</p> <p>The BMS firmware can be upgraded with one single CIM</p>	6.450,00€	1	6.450,00 €

SubCtech GmbH
Wellseedamm 1-3 • D-24145 KIEL • Germany
Managing Director: Dipl.-Phys. Stefan Marx
Amtsgericht Kiel HRB 11552 KI
VAT-Id.No. DE270099549

phone: +49 (0) 431-22039880
fax: +49 (0) 431-22039881
mobile: +49 (0) 178-35 21 99 2
email: info@subctech.com
web: www.subctech.com

Bank: Foerde Sparkasse
IBAN: DE92 2105 0170 1400 0559 58
BIC: NOLADE21KIE
The protection notice ISO 16016 applies to the content of this document.





		<p>interface to top-side PC or PowerCharger. Log files can be uploaded the other way around from the CIM to a PC or PowerCharger™.</p> <p>Data interface: MODBUS RTU, galvanic isolated CAN, CANopen (TCP, Ethernet on request)</p> <p><i>Incl.</i></p> <ul style="list-style-type: none"> - internal cable to the battery <p><i>Not Incl.</i></p> <ul style="list-style-type: none"> - underwater cables - pressure housing <p>Note: if NOT ordered, then</p> <ul style="list-style-type: none"> - no CAN interface is available - no customized data - no direct data download - no direct firmware update - no extensions such as PDU and Converter control 		
<p>11-60xx /HV/5 /500</p>	 <p>Photo comparable</p>	<p>Pressure housing Titanium 500m</p> <p>Titanium pressure housing, corrosion free and robust against mechanical stress e.g. on-board supply vessels. Double O-ring sealing protects against failures and water leaks. 1atm, not oil filled.</p> <p>Installation for battery, CIM controller, PDU fuse&switch, all connectors</p> <p>Burst pressure: 82 Bar Operating depth: 500 m Material: Titanium Size: Ø450 mm x L 1010 mm Weight: 99 kg (empty) 267 kg (battery complete, in air) 103 kg (battery complete, in sea water)</p> <p>Connector:</p> <ul style="list-style-type: none"> 1 x HV, SubConn HPBH 0 x LV Electronics, SubConn BH 1 x HV Charge, SubConn HPBH 2 x Data, SubConn BH <p>Control light: Dual color high-bright low-power LED Marking: Front cover</p> <p><i>Including:</i></p> <ul style="list-style-type: none"> - Complete with spare parts (seals, screws) - marking - connectors, dummy connectors - battery rail inside - lifting straps <p><i>Not Included:</i></p> <ul style="list-style-type: none"> - Pressure test (on request) - Underwater cables 	<p>2</p>	

<p>11-60xx /HV/5 /3000</p>  <p>Photo comparable</p>	<p>Alternative: Pressure housing Titanium 3000m</p> <p>Titanium pressure housing, corrosion free and robust against mechanical stress e.g. on-board supply vessels. Double O-ring sealing protects against failures and water leaks. 1atm, not oil filled.</p> <p>Installation for battery, CIM controller, PDU fuse&switch, all connectors</p> <p>Burst pressure: 360 Bar Operating depth: 3000 m Material: Titanium Size: Ø464 mm x L 1050 mm Weight: 183 kg (empty) 351 kg (battery complete, in air) 168 kg (battery complete, in sea water)</p> <p>Connector: 1 x HV, SubConn HPBH 0 x LV Electronics, SubConn BH 1 x HV Charge, SubConn HPBH 2 x Data, SubConn BH</p> <p>Control light: Dual color high-bright low-power LED Marking: Front cover</p> <p><i>Including:</i> - Complete with spare parts (seals, screws) - marking - connectors, dummy connectors - battery rail inside - lifting straps</p> <p><i>Not Included:</i> - Pressure test (on request) - Underwater cables</p>	<p>0</p>	
<p>11-60xx /HV/5 /6000</p>  <p>Photo comparable</p>	<p>Alternative: Pressure housing Titanium 6000m</p> <p>Titanium pressure housing, corrosion free and robust against mechanical stress e.g. on-board supply vessels. Double O-ring sealing protects against failures and water leaks. 1atm, not oil filled.</p> <p>Installation for battery, CIM controller, PDU fuse&switch, all connectors</p> <p>Burst pressure: 641 Bar Operating depth: 6000 m Material: Titanium Size: Ø476 mm x L 1084 mm Weight: 252 kg (empty) 420 kg (battery complete, in air) 220 kg (battery complete, in sea water)</p> <p>Connector: 1 x HV, SubConn HPBH 0 x LV Electronics, SubConn BH 1 x HV Charge, SubConn HPBH 2 x Data, SubConn BH</p> <p>Control light: Dual color high-bright low-power LED Marking: Front cover</p> <p><i>Including:</i> - Complete with spare parts (seals, screws) - marking - connectors, dummy connectors</p>	<p>0</p>	

SubCtech GmbH
Wellseedamm 1-3 • D-24145 KIEL • Germany
Managing Director: Dipl.-Phys. Stefan Marx
Amtsgericht Kiel HRB 11552 KI
VAT-Id.No. DE270099549

phone: +49 (0) 431-22039880
fax: +49 (0) 431-22039881
mobile: +49 (0) 178-35 21 99 2
email: info@subctech.com
web: www.subctech.com





Bank: Foerde Sparkasse
IBAN: DE92 2105 0170 1400 0559 58
BIC: NOLADE21KIE
The protection notice ISO 16016 applies to the content of this document.

		<ul style="list-style-type: none"> - battery rail inside - lifting straps <p>Not Included:</p> <ul style="list-style-type: none"> - Pressure test (on request) - Underwater cables 			
3-8550		<p>Optional Control lights</p> <p>Additional Low-power bright LED control flashing light for power up, charging, warning, error</p> <p>Depth rating: 1000m</p>		2	
7-1401 /HV		<p>UWCAB2/HP High-power cable, 2 plugs</p> <p>Length: 1,3m – other on request</p> <p>Connector 1: SubConn® -HP battery</p> <p>Connector 2: SubConn® -HP vehicle</p>		2	
7-1001		<p>UWCAB2 Underwater cable with 2 plugs</p> <p>Length: 1,3m – other on request</p> <p>Connector 1: SubConn® battery</p> <p>Connector 2: SubConn® Vehicle data</p>		2	
1-7401 /162V /2x10kW Customized	 <p>Photos comparable</p>	<p>Li-Ion PowerCharger™ 2 x 10 kW</p> <p>High-power Li-Ion charger with SmartBMS™ integration. Charger under control of the battery BMS. Incl. diagnosing and data logging.</p> <p>Two charge modules installed to charge two batteries in parallel.</p> <p>All parameter as specified above, core parameters are:</p> <p>Control: 7" Touch-screen, Control lights (alarm)</p> <p>Power input: 3-phases 400 VAC</p> <p>Charge output: 2 x 10 kW</p> <p>Charge time: 4h for 20-100% SOC 4-5h for full range charging</p> <p>Housing: Ruggedized 19" Flight-Case</p> <p>interface: MODBUS RTU</p> <p>Weight & size: approx. 75 kg</p> <p>Production: IPC-A-600/610 class 2</p> <p>Protection: IP65 lids closed</p> <p>Notes:</p> <ul style="list-style-type: none"> - Requires 64A 3-phases power supply for full power - Lids must be opened during operation <p>Including:</p> <ul style="list-style-type: none"> - Power supply (mains) cable <p>Not included:</p> <ul style="list-style-type: none"> - underwater connectors and cables - other components as offered in this quotation 		1	



SubCtech GmbH
 Wellseedamm 1-3 • D-24145 KIEL • Germany
 Managing Director: Dipl.-Phys. Stefan Marx
 Amtsgericht Kiel HRB 11552 KI
 VAT-Id.No. DE270099549

phone: +49 (0) 431-22039880
 fax: +49 (0) 431-22039881
 mobile: +49 (0) 178-35 21 99 2
 email: info@subctech.com
 web: www.subctech.com

Bank: Foerde Sparkasse
 IBAN: DE92 2105 0170 1400 0559 58
 BIC: NOLADE21KIE
 The protection notice ISO 16016 applies to the content of this document.

7-1401 /HV		UWCAB2/HP High-power cable, 2 plugs Length: 30 m – other on request Connector 1: Charger Connector Connector 2: SubConn® - power Connector 3: SubConn® - data		1	
9-9000		Spare parts Spare parts to operate the products. Spare part from other vendors as provided, if applicable. <ul style="list-style-type: none"> Spare screws and mechanical components, seals, firmware backup etc. Other spare parts as required 		2	
9-8000	 Photo comparable	Documentation <ul style="list-style-type: none"> Installation, operating and maintenance manual in English Interface documentation Quick-Setup sheet for on-board usage Declaration of origin Spare part list CE certificate with DIN/EN regularise Declaration of origin FAT certificate (according DIN EN 10204 3.1b) Transportation, storage and mobilisation indication Transport documentation according ADR, IATA, DGR Note: <ul style="list-style-type: none"> Other certificates on request 		2	
9-1200 /829 /frame	  Photo comparable	Optional certified metal box Transport & storage box (batteries) Robust "Zarges" box made of aluminium. Transport and storage box, with trays for all components. Special for Li-Ion batteries. The battery is stored and transported lying in a V-frame and/or non-flammable foam. <p>Material: Aluminium, wooden & stainless steel Operation: by crane or persons</p> <p>UN 4B / BAM approval, packing group 1, for hazardous goods class 1,2,3, for dangerous goods class 9</p> <p>According to ADR / RID / IATA-DGR und IMBG-Code for air cargo</p> <p>Notes: - for simple installation the transport frame can be removed - handling by crane inside or outside the complete box</p>		2	
Sub total			EURO NET		


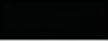

6.2 Quotation: Battery system - 9 modules – 64 kWh





Art.	Image	Component	Unit price EURO	QTY	Total Price EURO
1-22xx /64kWh /162V /A	 <p>Photo comparable</p>	<p>Li-Ion Series 416 - 162V – 64kWh</p> <p>High-Performance Li-Ion battery. All parameters as specified for the series, core parameters are:</p> <p>Output: direct battery output Switchable using the PDU unit</p> <p>Nominal Voltage: 162 VDC battery</p> <p>Voltage range: 130 VDC ... 185 VDC (V_min ... V_max)</p> <p>Nominal Energy: 64.0 kWh</p> <p>Available Energy: 60.2 kWh</p> <p>Power: 20 kW max. cont.</p> <p>Current: 150 A max cont. @V_min 200 A peak 10s @V_min TBD</p> <p>Interface: MODBUS RTU (CAN via CIM)</p> <p>Size: Ø416 mm x 1450 mm length (approx.)</p> <p>Weight: 295 kg in air, without pressure housing Without electronic (PDU, CIM, DC/DC)</p> <p>Operating temp.: -20 ...+60 °C (cell temp.)</p> <p>Charge temp.: +0 ...+45 °C (cell temp.)</p> <p>Storage: -20 ...+50°C (recommended: +5 ...+20°C) 50..80% SOC, recharge 3...6 months</p> <p>Including:</p> <ul style="list-style-type: none"> - Gliders and mounting blocks/Stopper blocks for rail mounting <p>Not including:</p> <ul style="list-style-type: none"> - PDU, CIM - Pressure housing - Underwater cables or connectors - NRE or qualifications - Other components as here mentioned 		2	
1-6720	 <p>Customized CIM controller to merge data interfaces Photo comparable</p>	<p>CIM control unit</p> <p>The "Customer Interface Module" (CIM) contain various functions. Several batteries can be interconnected here.</p> <p>The individual BMS interfaces of the battery modules are linked and various data outputs are available. These can be made available exclusively to the higher-level system (vehicle CPU), a diagnostic unit or external charger. There are several interface protocols such as serial RS-232, RS-485 NMEA-0183, MODBUS RTU or CAN / CANopen available.</p> <p>The power outputs can be equipped with PDU (Power Distribution Unit) channels. This means that each output is individually switchable and individually protected. Currents, voltages and temperatures as well as short circuits are recorded. External short circuits or an interchanged connection are protected by optional fuses.</p> <p>The BMS firmware can be upgraded with one single CIM interface to top-side PC or PowerCharger. Log files can be uploaded the other way around from the CIM to a PC or PowerCharger™.</p>		1	

SubCtech GmbH
Wellseedamm 1-3 • D-24145 KIEL • Germany
Managing Director: Dipl.-Phys. Stefan Marx
Amtsgericht Kiel HRB 11552 KI
VAT-Id.No. DE270099549

phone: +49 (0) 431-22039880
fax: +49 (0) 431-22039881
mobile: +49 (0) 178-35 21 99 2
email: info@subctech.com
web: www.subctech.com

Bank: Foerde Sparkasse
IBAN: DE92 2105 0170 1400 0559 58
BIC: NOLADE21KIE
The protection notice ISO 16016 applies to the content of this document.





		<p>Data interface: MODBUS RTU, galvanic isolated CAN, CANopen (TCP, Ethernet on request)</p> <p><i>Incl.</i></p> <ul style="list-style-type: none"> - internal cable to the battery <p><i>Not Incl.</i></p> <ul style="list-style-type: none"> - underwater cables - pressure housing <p>Note: if NOT ordered, then</p> <ul style="list-style-type: none"> - no CAN interface is available - no customized data - no direct data download - no direct firmware update - no extensions such as PDU and Converter control 			
<p>11-60xx /HV/9 /500</p>	 <p>Photo comparable</p>	<p>Pressure housing Titanium 500m</p> <p>Titanium pressure housing, corrosion free and robust against mechanical stress e.g. on-board supply vessels. Double O-ring sealing protects against failures and water leaks. 1atm, not oil filled.</p> <p>Installation for battery, CIM controller, PDU fuse&switch, all connectors</p> <p>Burst pressure: 78 Bar Operating depth: 500 m Material: Titanium Size: Ø454 mm x L 1610 mm Weight: 157 kg (empty) 452 kg (battery complete, in air) 186 kg (battery complete, in sea water)</p> <p>Connector: 1 x HV, SubConn HPBH 0 x LV Electronics, SubConn BH 1 x HV Charge, SubConn HPBH 2 x Data, SubConn BH</p> <p>Control light: Dual color high-bright low-power LED Marking: Front cover</p> <p><i>Including:</i></p> <ul style="list-style-type: none"> - Complete with spare parts (seals, screws) - marking - connectors, dummy connectors - battery rail inside - lifting straps <p><i>Not Included:</i></p> <ul style="list-style-type: none"> - Pressure test (on request) - Underwater cables 		<p>2</p>	

<p>11-60xx /HV/9 /3000</p>  <p>Photo comparable</p>	<p>Alternative: Pressure housing Titanium 3000m</p> <p>Titanium pressure housing, corrosion free and robust against mechanical stress e.g. on-board supply vessels. Double O-ring sealing protects against failures and water leaks. 1atm, not oil filled.</p> <p>Installation for battery, CIM controller, PDU fuse&switch, all connectors</p> <p>Burst pressure: 357 Bar Operating depth: 3000 m Material: Titanium Size: Ø474 mm x L 1650 mm Weight: 302 kg (empty) 597 kg (battery complete, in air) 297 kg (battery complete, in sea water)</p> <p>Connector: 1 x HV, SubConn HPBH 0 x LV Electronics, SubConn BH 1 x HV Charge, SubConn HPBH 2 x Data, SubConn BH</p> <p>Control light: Dual color high-bright low-power LED Marking: Front cover</p> <p><i>Including:</i> - Complete with spare parts (seals, screws) - marking - connectors, dummy connectors - battery rail inside - lifting straps</p> <p><i>Not Included:</i> - Pressure test (on request) - Underwater cables</p>	<p>0</p>	
<p>11-60xx /HV/9 /6000</p>  <p>Photo comparable</p>	<p>Alternative: Pressure housing Titanium 6000m</p> <p>Titanium pressure housing, corrosion free and robust against mechanical stress e.g. on-board supply vessels. Double O-ring sealing protects against failures and water leaks. 1atm, not oil filled.</p> <p>Installation for battery, CIM controller, PDU fuse&switch, all connectors</p> <p>Burst pressure: 636 Bar Operating depth: 6000 m Material: Titanium Size: Ø484 mm x L 1684 mm Weight: 386 kg (empty) 681 kg (battery complete, in air) 360 kg (battery complete, in sea water)</p> <p>Connector: 1 x HV, SubConn HPBH 0 x LV Electronics, SubConn BH 1 x HV Charge, SubConn HPBH 2 x Data, SubConn BH</p> <p>Control light: Dual color high-bright low-power LED Marking: Front cover</p> <p><i>Including:</i> - Complete with spare parts (seals, screws) - marking - connectors, dummy connectors</p>	<p>0</p>	

SubCtech GmbH
Wellseedamm 1-3 • D-24145 KIEL • Germany
Managing Director: Dipl.-Phys. Stefan Marx
Amtsgericht Kiel HRB 11552 KI
VAT-Id.No. DE270099549

phone: +49 (0) 431-22039880
fax: +49 (0) 431-22039881
mobile: +49 (0) 178-35 21 99 2
email: info@subctech.com
web: www.subctech.com





Bank: Foerde Sparkasse
IBAN: DE92 2105 0170 1400 0559 58
BIC: NOLADE21KIE
The protection notice ISO 16016 applies to the content of this document.

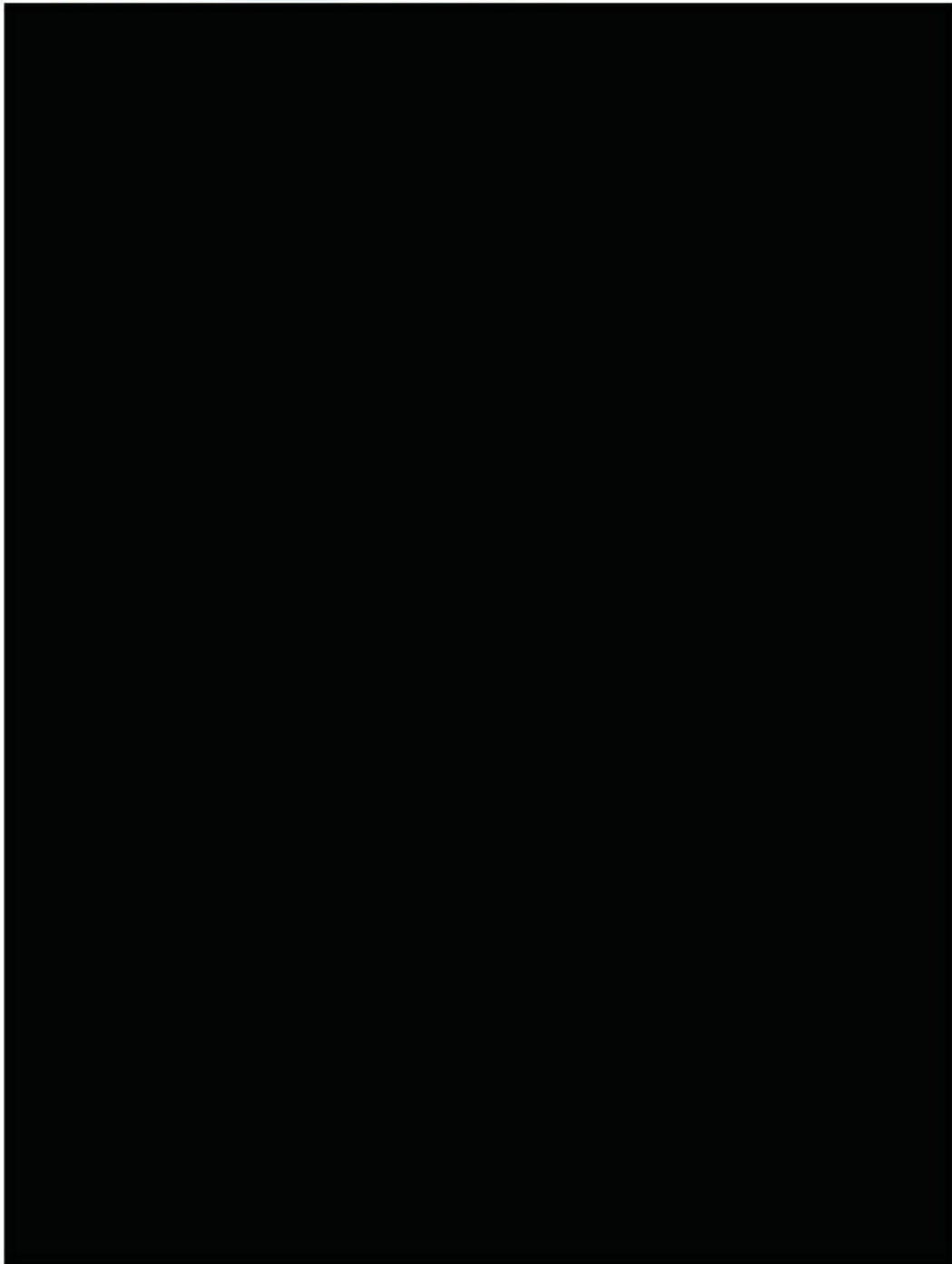
		<ul style="list-style-type: none"> - battery rail inside - lifting straps <p><i>Not Included:</i></p> <ul style="list-style-type: none"> - Pressure test (on request) - Underwater cables 			
3-8550 /3000		<p>Optional Control lights</p> <p>Additional Low-power bright LED control flashing light for power up, charging, warning, error</p> <p>Depth rating: 3000m</p>		2	
7-1401 /HV		<p>UWCAB2/HP High-power cable, 2 plugs</p> <p>Length: 1,3m – other on request</p> <p>Connector 1: SubConn® -HP battery</p> <p>Connector 2: SubConn® -HP vehicle</p>		2	
7-1001		<p>UWCAB2 Underwater cable with 2 plugs</p> <p>Length: 1,3m – other on request</p> <p>Connector 1: SubConn® battery</p> <p>Connector 2: SubConn® Vehicle data</p>		2	
1-7401 /162V /2x15kW Customized	 Photos comparable	<p>Li-Ion PowerCharger™ 2 x 15 kW</p> <p>High-power Li-Ion charger with SmartBMS™ integration. Charger under control of the battery BMS. Incl. diagnosing and data logging.</p> <p>Two charge modules installed to charge two batteries in parallel.</p> <p>All parameter as specified above, core parameters are:</p> <p>Control: 7" Touch-screen, Control lights (alarm)</p> <p>Power input: 3-phases 400 VAC</p> <p>Charge output: 2 x 15 kW</p> <p>Charge time: 4h for 20-100% SOC 4-5h for full range charging</p> <p>Housing: Ruggedized 19" Flight-Case</p> <p>interface: MODBUS RTU</p> <p>Weight & size: approx. 75 kg</p> <p>Production: IPC-A-600/610 class 2</p> <p>Protection: IP65 lids closed</p> <p><i>Notes:</i></p> <ul style="list-style-type: none"> - Requires 64A 3-phases power supply for full power - Lids must be opened during operation <p><i>Including:</i></p> <ul style="list-style-type: none"> - Power supply (mains) cable <p><i>Not included:</i></p> <ul style="list-style-type: none"> - underwater connectors and cables - other components as offered in this quotation 		1	

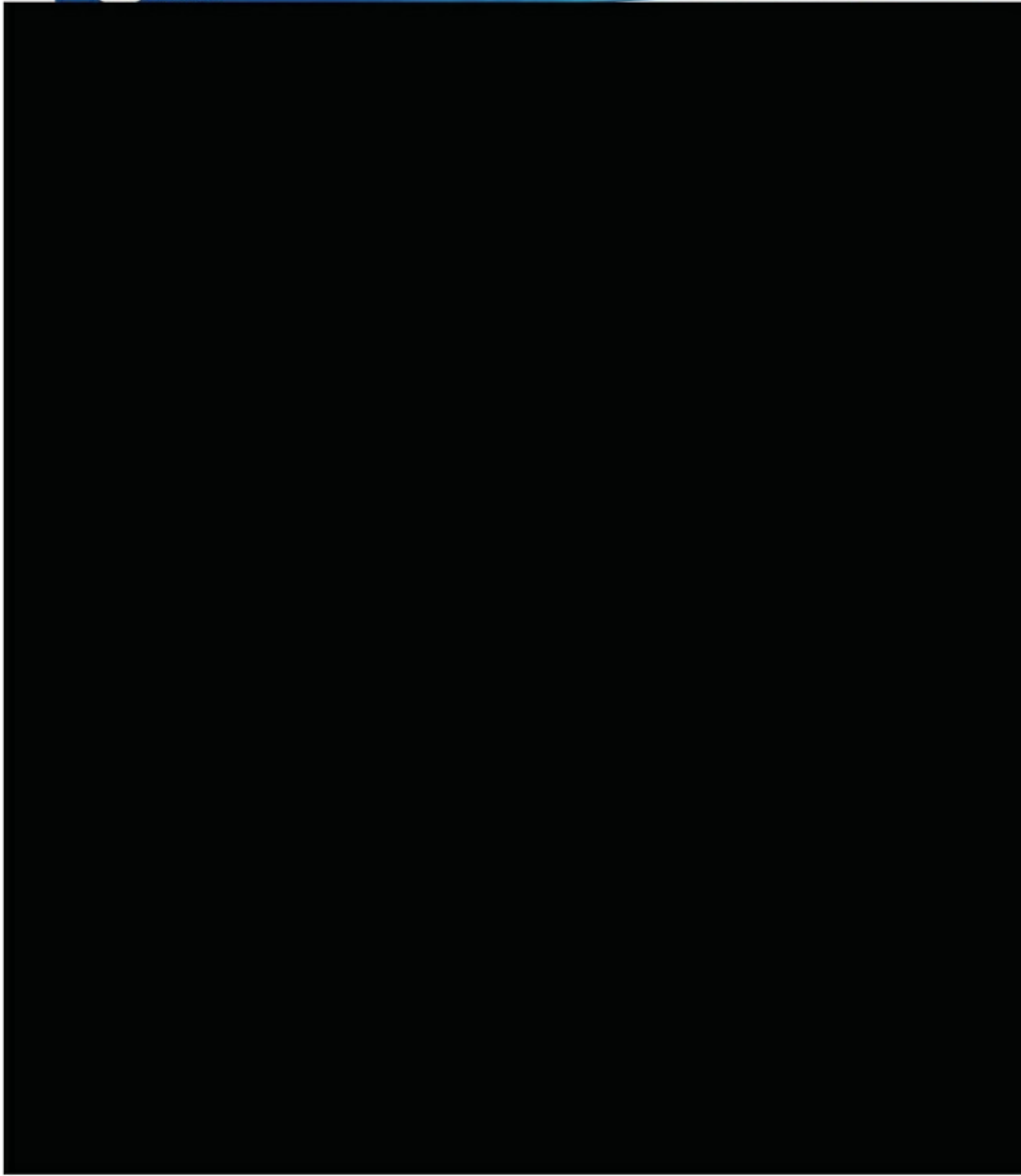
SubCtech GmbH
Wellseedamm 1-3 • D-24145 KIEL • Germany
Managing Director: Dipl.-Phys. Stefan Marx
Amtsgericht Kiel HRB 11552 KI
VAT-Id.No. DE270099549

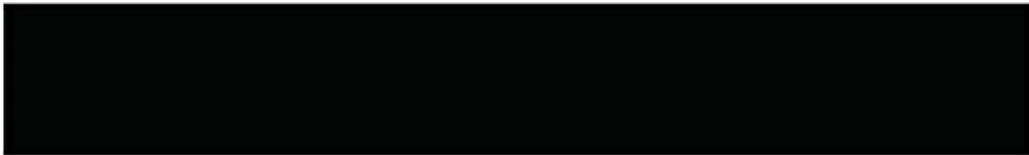
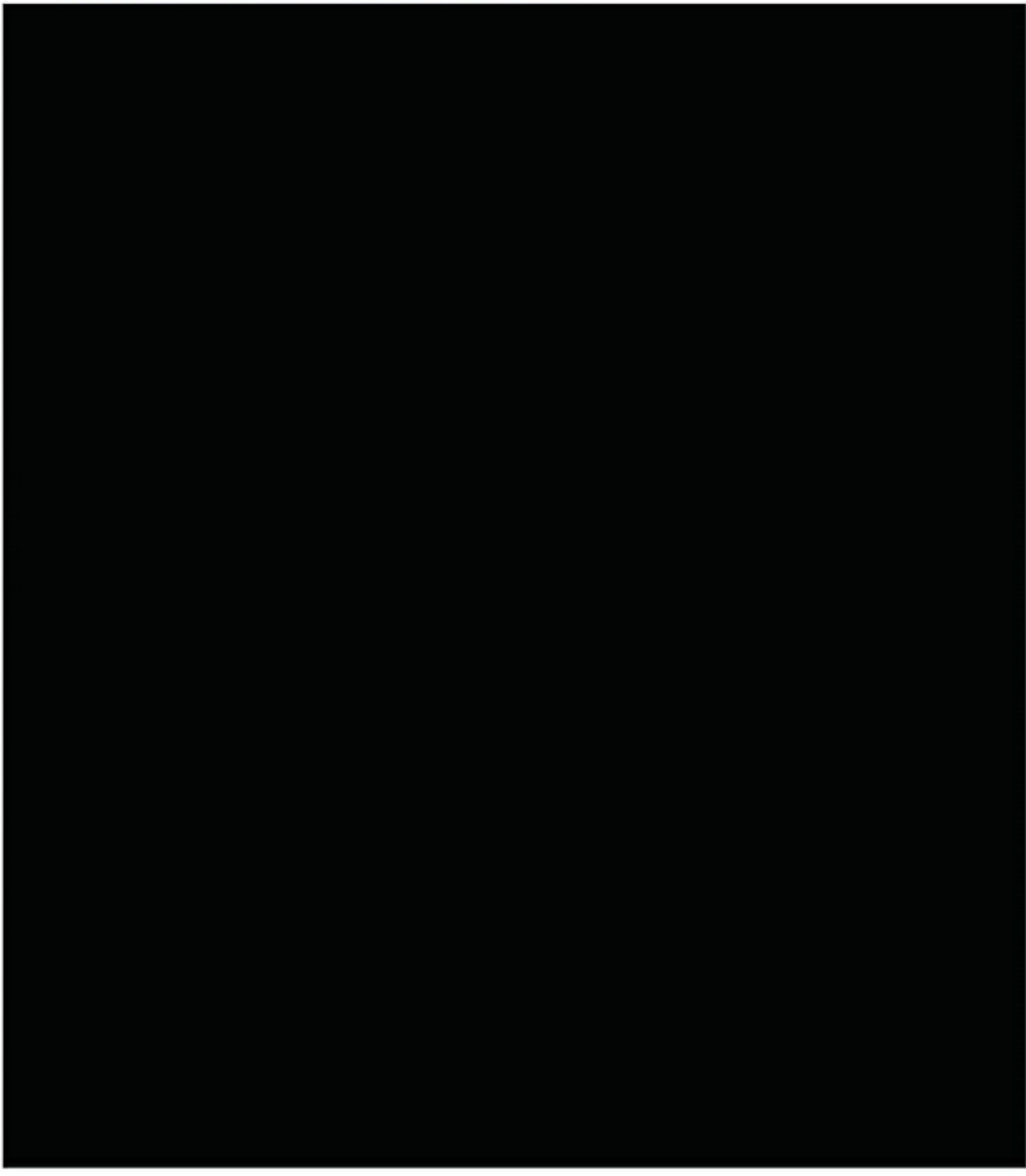
phone: +49 (0) 431-22039880
fax: +49 (0) 431-22039881
mobile: +49 (0) 178-35 21 99 2
email: info@subctech.com
web: www.subctech.com

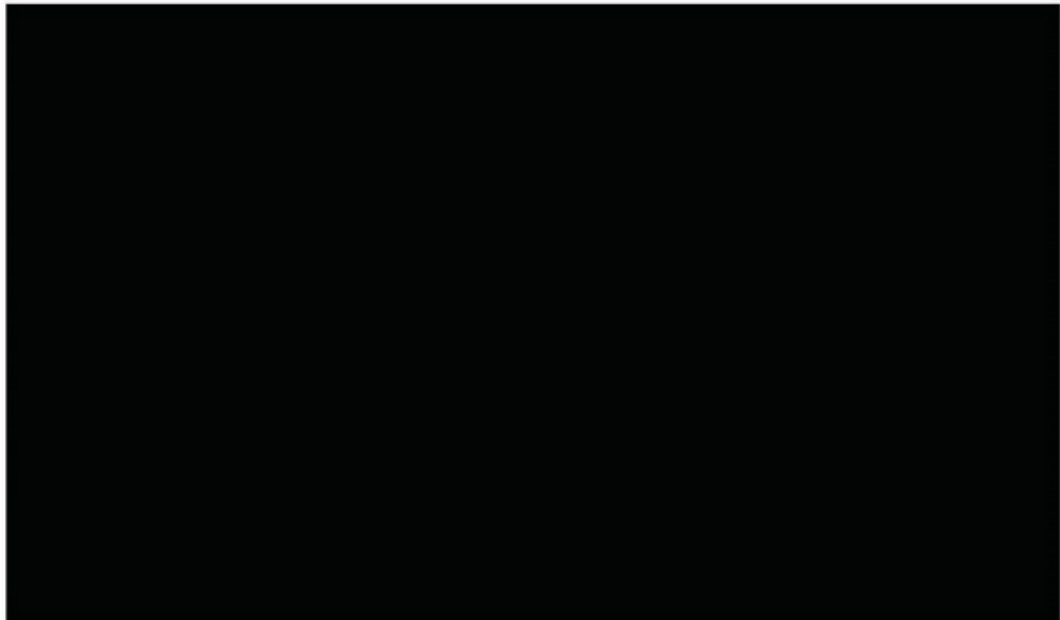
Bank: Foerde Sparkasse
IBAN: DE92 2105 0170 1400 0559 58
BIC: NOLADE21KIE
The protection notice ISO 16016 applies to the content of this document.

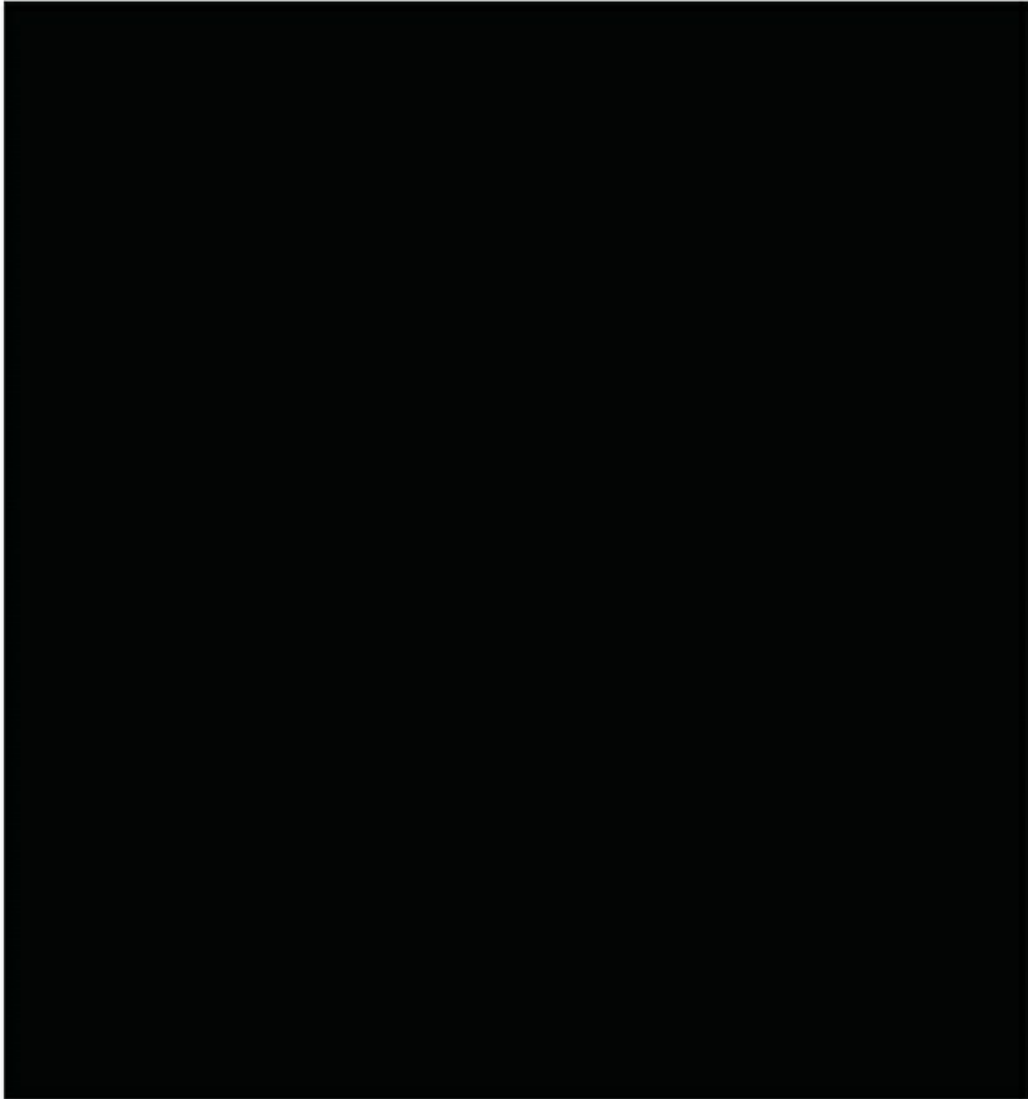
7-1401 /HV		UWCAB2/HP High-power cable, 2 plugs Length: 30 m – other on request Connector 1: Charger Connector Connector 2: SubConn® - power Connector 3: SubConn® - data		1	
9-9000		Spare parts Spare parts to operate the products. Spare part from other vendors as provided, if applicable. <ul style="list-style-type: none"> Spare screws and mechanical components, seals, firmware backup etc. Other spare parts as required 		2	
9-8000	 Photo comparable	Documentation <ul style="list-style-type: none"> Installation, operating and maintenance manual in English Interface documentation Quick-Setup sheet for on-board usage Declaration of origin Spare part list CE certificate with DIN/EN regularise Declaration of origin FAT certificate (according DIN EN 10204 3.1b) Transportation, storage and mobilisation indication Transport documentation according ADR, IATA, DGR Note: <ul style="list-style-type: none"> Other certificates on request 		2	
9-1200 /829 /frame	  Photo comparable	Optional certified metal box only available for batteries up to 1500mm length Transport & storage box (batteries) Robust "Zarges" box made of aluminium. Transport and storage box, with trays for all components. Special for Li-Ion batteries. The battery is stored and transported lying in a V-frame and/or non-flammable foam. <p>Material: Aluminium, wooden & stainless steel Operation: by crane or persons</p> <p>UN 48 / BAM approval, packing group 1, for hazardous goods class 1,2,3, for dangerous goods class 9</p> <p>According to ADR / RID / IATA-DGR und IMBG-Code for air cargo</p> Notes: <ul style="list-style-type: none"> - for simple installation the transport frame can be removed - handling by crane inside or outside the complete box 		0	
Sub total			EURO NET		

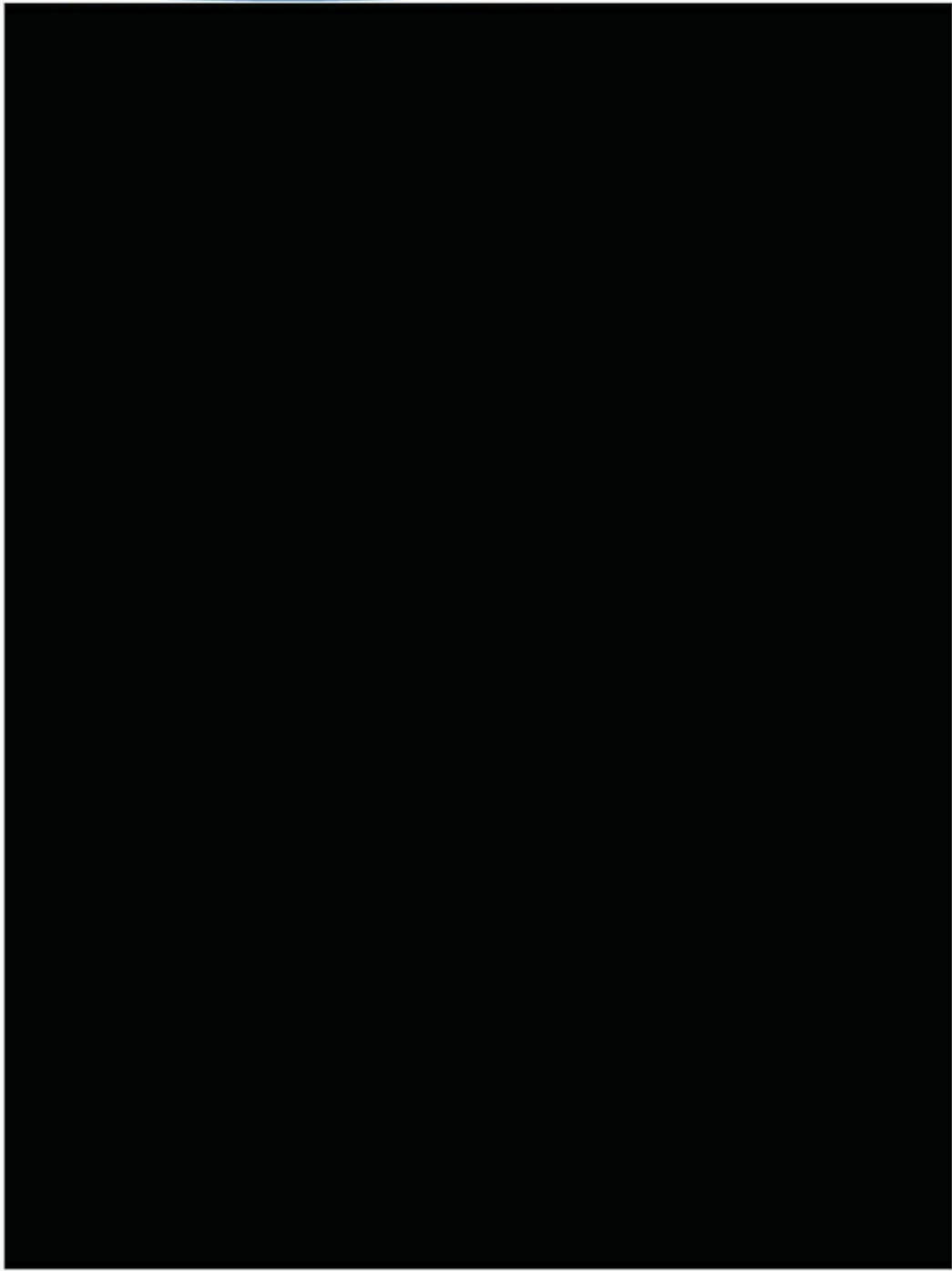












CERTAIN IDENTIFIED INFORMATION HAS BEEN EXCLUDED FROM THIS EXHIBIT BECAUSE IT IS BOTH NOT MATERIAL AND IS THE TYPE THAT THE REGISTRANT TREATS AS PRIVATE OR CONFIDENTIAL.

DocuSign Envelope ID: 2C551645-5F9C-4C1C-8C0F-753F6AF43A6E



FABRICATION AGREEMENT Time & Materials Contract

COMPANY: Nauticus Robotics, Inc. (Nauticus)	CONTRACT NO: AQ001012022
ADDRESS: 17146 Feathercraft Ln, Suite 450 Webster, TX 77598 Attn: Reg Berka (281)-942-9069 e-mail: rberka@nauticusrobotics.com	Time & Materials: Expected 6 to 9 months per rate schedule (actual direct cost)

INTRODUCTION

This Fabrication Agreement ("Agreement"), effective January 17, 2022, is made between Nauticus Robotics, Inc. (hereinafter known as "Nauticus" or "Company"), and International Submarine Engineering Ltd. (hereinafter known as "ISE" or "Fabricator"). Nauticus to provide preliminary design of the Aquanaut system and supply all key components, sensors, manipulators, telemetry, pressure cans, cables, connectors, valve packs, cameras, lights, actuators, batteries, thrusters, etc. in reasonable time to not delay completion.

Nauticus may request ISE to aid in the procurement, fabrication and assembly of the above items based on drawings provided by Nauticus.

ISE will assist with the final assembly design of the overall system, specifically the center and aft section to meet the specification within the footprint specified. ISE will assist with agreed upon procurement and fabrication at its facilities in Port Coquitlam, British Columbia. ISE will provide assembly, component testing and pool testing of the three (3) fully functional and operating Aquanaut subsea vehicles ("ASVs"), in accordance with the terms and conditions set forth therein, and any document referenced herein ("Work").

TERMS AND CONDITIONS

1.0 TERM

The term of this Agreement shall commence upon the effective date above.

2.0 CONTRACT SUM

Company shall pay Fabricator the amounts in current funds for the Fabricator's performance of the Work ("Contract Sum"). The Contract Sum includes the reasonable and necessary cost to perform all Work necessary to provide complete, useable, fully-operational ASVs, as shown in the final approved drawings and specifications and reasonably inferable therefrom, whether or not all items of Work are explicitly shown on or included in the final drawings and specifications. The Contract Sum for this time and materials contract is based on actual materials cost (including Fabricator's suppliers' and subcontractors' costs) and the reasonable and necessary direct labor charged on the rate table as shown in Attachment II. The Contract Sum includes all applicable Canadian federal, provincial and local taxes and duties including, but not limited to, Canadian sales, use and value-added taxes, arising out of or relating to Fabricator's delivery of goods or services to Nauticus' designated location, and including Fabricator's performance of Work under this Agreement. Fabricator shall perform all Work in as efficient manner as possible to avoid rates in excess of 1.0 X the hourly rates set forth in Attachment II. Rates exceeding 1.0 X the hourly rates set forth in Attachment II must be authorized in advance in writing by Company. Given

NAUTICUS ROBOTICS

www.nauticusrobotics.com
{02032936; 1}

17146 FEATHERCRAFT LANE, SUITE 450
WEBSTER, TX 77598
(281) 942-9069



the aggressive timeline, it is safe to assume OT will be required. ISE would like to have 8 hr reg + 3 hr @1.5 X per person (Monday – Friday) approved at this agreement level. Anything above that, Weekends, and STAT holidays will require email approval from the customer's Project Manager or delegate in advance. For the avoidance of doubt, Fabricator is not responsible or liable for any taxes, duties, or levies of any country, state, or local government or any other jurisdiction other than those imposed by Canadian governments or jurisdictions.

Fabricator shall retain a customs broker in British Columbia to provide import services for shipments from Company to Fabricator, including without limitation arranging and paying any requisite Canadian government taxes, duties, and charges on behalf of Fabricator and obtaining the release of goods from Canadian Government agencies and departments. All fees, charges, and disbursements of the Fabricator's customs broker (including without limitation all payments made to Canadian Government agencies and departments) shall be included in Fabricator's invoices and paid by Company.

Company shall retain a customs broker in the United States to provide import services for shipments from Fabricator to Company, including without limitation arranging and paying any requisite Canadian or United States government taxes, duties, and charges and obtaining the release of goods from Canadian and United States Government agencies and departments. Company shall pay for all fees, charges, and disbursements of the Company's customs broker (including without limitation all payments made to Canadian or United States Government agencies and departments).

3.0 DELIVERY/SCHEDULE

3.1 The ASVs and all Work under this Agreement shall be delivered in accordance with this Agreement, including as set forth in Attachment I. TIME IS OF THE ESSENCE WITH REGARD TO FABRICATOR'S OBLIGATIONS UNDER THIS AGREEMENT. The ASVs furnished under this Agreement shall be delivered FOB to Company's location. Nauticus shall pay for all packaging, delivery, carrier, and shipping costs. Delivery shall not be deemed complete until all ASVs and materials have been received and accepted by Nauticus, notwithstanding delivery to any carrier. Services shall be deemed delivered after they have been performed, received, and accepted by Nauticus. A timeline for completing acceptance will be specified in the Statement of Work. Fabricator is not responsible for any delays caused by supply chain issues (provided that Fabricator uses reasonable measures to mitigate any such delays) or the Customer.

3.2 Within thirty (30) days of receipt of a shipment of each ASV, Company shall have the opportunity to inspect the completed Work and may specify in writing to Fabricator any claims that the ASVs are not in compliance with the terms or specifications of this Agreement or Fabricator's warranties hereunder. In case of any defect in any of the ASVs so specified in writing, Fabricator shall (a) rework, repair or replace the defective Work, or (b) if the remedy described in (a) is not possible, issue a credit to Company for value of the defective ASV. Fabricator's obligation to rework, repair or replace defective Work does not include any defective item or material provided by Nauticus.

4.0 INVOICES

Fabricator shall submit invoices electronically to the Nauticus Project Manager (PM) shown in Section 6.0. In addition, invoices should be copied to aberka@nauticusrobotics.com and ap@nauticusrobotics.com. Submit invoices individually with only ONE invoice attached per email request (required supporting cost data should be provided with the invoice in a single PDF file). The subject line must be in the following format: Contract/PO No/Invoice No/Invoice Amount. Invoices shall be submitted to Nauticus in accordance with Article 4.0 and shall contain the following information as the billed-to name and address: Nauticus Robotics, Inc. 17146 Feathercraft Ln, Suite 450, Webster, TX. 77598; and Fabricator's name and remit-to address, quantities, description of item/work, unit prices and extended prices, and/or total cost. Invoices shall clearly reference a unique invoice number on each invoice and the date of the invoice. Invoices shall include, as applicable, the "Amount Previously Billed" and the "Amount of this Invoice." The Payment Terms on the invoice should reflect Net 30 days.

Invoices shall cover costs for a complete month (i.e. January 1 – January 31) and delivered to Nauticus by the 10th day of the following month. Invoices shall have complete time records for labor charges and receipts/bills/vendor invoices for any non-labor, materials cost. This supporting data shall be contained in

NAUTICUS ROBOTICS

www.nauticusrobotics.com
{02032936; 1}

17146 FEATHERCRAFT LANE, SUITE 450
WEBSTER, TX 77598
(281) 942-9069



a single electronic file of PDF format. Supplier costs that are paid in advance can be included in the monthly invoice with the corresponding vendor bill for the advance payment as supporting documentation. If an advance payment is made without a vendor bill, the supporting documentation must include a copy of the PO, with proper notation of advance payment, and documentation of the advance payment (i.e. bank statement, electronic payment receipt, cancelled check).

5.0 PAYMENT

Payment terms are Net 30 Days after receipt of a proper invoice from Fabricator unless otherwise specified in this Agreement. Fabricator may select Automated Clearing House payments ("ACH funds transfer") as the means of payment. With regard to such ACH funds transfer, a payment from Nauticus to Fabricator shall be considered timely with respect to any payment due date if the ACH funds transfer is completed by the payment due date. Nauticus shall not be in breach of these terms and conditions, or suffer any loss of discount or other penalty, with respect to an ACH funds transfer that was initiated properly and timely by Nauticus, but its completion was delayed because of failure or delay by the ACH funds transfer system, the operation of an ACH funds transfer system rule which could not be anticipated by Nauticus, or rejection by the Fabricator's bank. Late payments will incur a late fee calculated as 10% per annum pro rated to the number of days late. Disputed amounts will be identified within 30 days of the Fabricator invoice and not subject to late fees.

5.1 SUPPORTING DOCUMENTATION

Fabricator shall submit invoices to Company for all Work within 10 days from the end of the month the Work was performed. Fabricator's invoice shall be accompanied by all supporting documentation necessary to enable Company to verify all amounts charged, including without limitation, payroll records (hours, employee name, employee classification, multiplier breakdown etc.) that account for total time worked under the Agreement; signed receipts for cash payroll; invoices (including all back-up details) for purchases, receiving and issuing documents, and all inventory records for Fabricator's stock or capital items; paid invoices, receipts, fees paid or received, and supplier and third-party charges; records of required licenses and permits, insurance, applicable safety and accident procedures; records relating to air freight and ground transportation, including but not limited to handling, hauling, and disposing of materials/equipment; accurate, auditable records of gifts, entertainment, and gratuities to individual Company personnel (Fabricator shall assist Company with respect to ensuring that all subcontractors and suppliers adhere to and comply with the above requirements). Company shall pay Fabricator at the rate stipulated in the Attachment II. Company shall pay all undisputed amounts to Fabricator within 30 days after receipt of Fabricator's invoice. If Company disputes any portion of an invoice received, Company will notify Fabricator of the item(s) disputed and payment of such item(s) may be withheld until such time as Company, in its sole determination, has received sufficient information to support payment of the disputed amount. Company may, in its sole discretion, pay disputed item(s) without waiver of its right to seek reimbursement at a later time. Payments to Fabricator may be withheld, in whole or in part, by Company if (a) Company reasonably determines that the withholding is necessary to protect Company from claims or losses due to Fabricator's failure to comply with the Agreement; (b) Fabricator fails to furnish proof satisfactory to Company that all bills for material and labor have been fully paid by Fabricator and its subcontractors; (c) the Work was not performed to the reasonable satisfaction of the Company; (d) goods, equipment, and facilities to which such payment relates are not reasonably satisfactory to Company; or (e) Fabricator has not provided proof that all liens and privileges of Fabricator's suppliers and subcontractors arising out of the Work have been fully released. Company may at its option apply any amounts due to Fabricator to the payment of any sums that Fabricator may owe to Company or to its subcontractors. Company may recover any overpayments made to Fabricator by mistake of law or fact. Interest shall not accrue (a) for charges disputed by Company, (b) with respect to any invoices that do not include sufficient support documentation or that are not timely submitted within said 10 day period, or (c) for any payment withheld by Company as provided in this Agreement. Notwithstanding anything contained in this Agreement to the contrary, Company shall have no responsibility or obligation for payment of any invoices received by Company more than 90 days following the last day of the calendar month in which the services were performed or related expenses incurred. Invoices for ISE proprietary parts will be invoiced as material sold to ISE for the project.

NAUTICUS ROBOTICS

www.nauticusrobotics.com
{02032936; 1}

17146 FEATHERCRAFT LANE, SUITE 450
WEBSTER, TX 77598
(281) 942-9069

5.2 AUDIT

At any time before final payment under this Agreement, Nauticus may request audit of the invoices or vouchers and supporting documentation. Fabricator shall accommodate any such Nauticus request, but may request that Nauticus and Fabricator execute a non-disclosure agreement to provide for the confidentiality of the information that is exchanged. Any physical audit to be done at ISE.

5.3 CLOSEOUT

At the completion of the Work under this Agreement, a completion invoice bearing the statement "COMPLETION INVOICE" is to be sent by Fabricator to Nauticus within 60 days of completion of the Work.

Nauticus may unilaterally close-out this Agreement if the Fabricator fails to submit close-out documentation requested by Nauticus or submit the COMPLETION INVOICE.

5.4 RETENTION OF RECORDS

Unless a longer period is specified in this Agreement or by law or regulation, Fabricator shall provide Nauticus access to such records for a period of 3 years at no additional cost upon request.

6.0 CONTRACT PROJECT MANAGER (PM), TECHNICAL, AND PROJECT REPRESENTATIVES

The following authorized representatives are hereby designated for this Agreement:

FABRICATOR:		NAUTICUS:	
TECHNICAL:		TECHNICAL:	Jide Akinyode
PHONE:		PHONE:	281-942-9069
EMAIL:		EMAIL:	jakinyode@nauticusrobotics.com
CONTRACT:		CONTRACT:	Reg Berka
PHONE:		PHONE:	281-942-9069
EMAIL:		EMAIL:	rberka@nauticusrobotics.com
PROJ MGR:		PROJ MGR:	Jide Akinyode
PHONE:		PHONE:	281-942-9069
EMAIL:		EMAIL:	jakinyode@nauticusrobotics.com

Only the Nauticus Contract Representative has the authority on behalf of Nauticus to make changes to this Agreement, which can be done only in a writing signed by the Nauticus Contract Representative. Either party may change its Technical or Project representative at any time, provided prompt notice is provided to the other party. All notices or other written communication required or permitted to be given under any provision of this Agreement shall be in writing and shall be deemed to have been given by the notifying party if delivered by hand, facsimile (with confirmed receipt), electronic media (with confirmed receipt) or mailed by an overnight delivery service, to the receiving party's above-identified contractual representative. The PM is the individual to provide technical and programmatic oversight and management of the Fabricator, to provide an independent assessment of the Fabricator's performance, and to identify, escalate, and resolve Fabricator performance issues.

7.0 WARRANTY

Fabricator expressly warrants that all Work provided under this Agreement shall be good quality, new, merchantable, free from defects in material and workmanship, of the highest quality, shall conform to all

NAUTICUS ROBOTICS

www.nauticusrobotics.com
{02032936; 1}

17146 FEATHERCRAFT LANE, SUITE 450
WEBSTER, TX 77598
(281) 942-9069

applicable specifications and appropriate standards, and does not and will not give rise to any infringement or misappropriation of any privacy, publicity, patent, copyright, trade secret, trademark or other intellectual property right of any third party. Fabricator warrants that any services provided under this Agreement shall be performed in accordance with the specifications and instructions of Nauticus, and with that degree of skill and judgment exercised by recognized professional firms performing same or similar services. Fabricator shall extend all warranties it receives from its vendors to Nauticus and to Nauticus' customers to whatever extent Fabricator can legally do so. Fabricator shall provide Nauticus with its Standard Warranty of one year commencing from delivery to FOB site. Fabricator makes no warranties or representations other than those expressly set forth in this Agreement and Nauticus waives any warranties implied under applicable law. Fabricator's warranties do not apply to third-party components and items (including software) provided, designed, or specifically required by Nauticus.

8.0 INSPECTION

All goods furnished and services performed pursuant hereto shall be subject to inspection and test by Nauticus at all reasonable times and places, during the Agreement term, and notwithstanding the terms of delivery or payment or that title has not yet passed to Nauticus or its customers, and in any event, prior to Final Acceptance as that term will be defined in the Statement of Work and Schedule to be attached to this Agreement as Attachment 1. No inspection made, or failure to make any inspection, prior to Final Acceptance shall relieve Fabricator from responsibility for defects or other failure to meet the requirements of this Agreement. In the event that goods furnished or services supplied are not in accordance with the Statement of Work and Schedule or other requirements, Nauticus may require Fabricator to promptly correct, repair or replace the goods or services. Fabricator is not responsible for any delays caused by Nauticus' or its customers' inspection.

9.0 INSURANCE

Without prejudice to Fabricator's liability to indemnify Nauticus as stated in any Indemnification provision contained in this Agreement, Fabricator shall procure at its expense and maintain for the duration of this Agreement, and ensure that any of its subcontractors used in connection with this Agreement procure and maintain, the insurance policies required below.

- a. **Commercial General Liability:** Coverage for third party bodily injury and property damage, including products and completed operations, contractual liability, and independent contractor's liability with limits not less than \$5,000,000 per occurrence and \$5,000,000 in the aggregate. Such policy(ies) shall be endorsed to name Nauticus Robotics, Inc., its directors, officers and employees, and Nauticus' customer where required by Nauticus, as Additional Insureds.
- b. **Professional Liability / Errors and Omissions:** Fabricator is performing professional services, therefore, Fabricator shall maintain coverage for liabilities, punitive damages, and claim expenses arising from errors, omissions, or negligent acts in rendering or failing to render professional services, computer or information technology services and in the provisioning of products in the performance of this Agreement, including the failure of products to perform the intended function or serve the intended purposes, with limits not less than \$5,000,000. Coverage for violation of software copyright is to be included. Services to be insured include but are not limited: (1) systems analysis; (2) systems programming; (3) data processing; (4) systems integration; (5) outsourcing, including outsourcing development and design; (6) system design, consulting, development and modification; (7) training services relating to computer software or hardware; (8) management, repair and maintenance of computer products, networks and systems; (9) marketing, selling, servicing, distributing, installing and maintaining computer hardware or software; and (10) data entry, modification, verification, maintenance, storage, retrieval or preparation of data output, and any other technology related services provided by the Fabricator.
- c. **Network Security/Privacy and Privacy Notification Costs (Cyber) Insurance:** If Fabricator is providing services that provide or include direct access to Company's or Company's Client's information technology systems or holding sensitive information of Company or Company's Client, then the above Technology Errors & Omissions insurance shall also include: Network Security /Privacy and

NAUTICUS ROBOTICS

www.nauticusrobotics.com
{02032936; 1}

17146 FEATHERCRAFT LANE, SUITE 450
WEBSTER, TX 77598
(281) 942-9069



PrivacyNotification Costs (Cyber) Insurance: Coverage for loss, disclosure and theft of data in any form; media and content rightsinfringement and liability, including but not limited to, software copyright infringement; network security failure, including but not limited to, denial of service attacks and transmission of malicious code. Coverage shall include data breach regulatory fines and penalties, the cost of notifying individuals of a security or data breach, the cost of credit monitoring services and any other causally- related crisis management expense for up to one (1) year with limits not less than \$5,000,000. Coverage shall contain severability for the insured organization for any intentional act exclusions.

Additionally, such policy(ies) required in (b) and (c) above shall cover consequential or vicarious liability (e.g. claims brought against Company or its Affiliated Companies and their respective directors, officers, and employees due to the wrongful acts and failures committed by Fabricator) and direct losses (e.g. claims made by Nauticus and its Affiliated Companies and their respective directors, officers, and employees against Fabricator for financial loss due to Fabricator's wrongful acts or failures). And, such policy(ies) shall also have the "Insured versus Insured" exclusion amended to allow an "Additional Insured" to bring a claim against the Named Insured. If the insurance required in (b) and/or (c) above are provided on a claims-made basis, then it must be maintained for a period of four (4) years after acceptance of the deliverables and/or services provided in connection with this Agreement.

The Additional Insured coverages above shall be primary and non-contributing with respect to any other insurance that may be maintained by Nauticus and notwithstanding any provision contained herein, the Fabricator, and its employees, agents, representatives, consultants, contractors and suppliers, are not insured by Nauticus, and are not covered under any policy of insurance that Nauticus has obtained or has in place.

Any self-insured retentions, deductibles and exclusions in coverage in the policies required under this Article shall be assumed by, for the account of, and at the sole risk of Fabricator. In no event shall the liability of Fabricator or any Fabricators be limited to the extent of any of insurance or the minimum limits required herein.

Prior to commencement of any work, and within 15 days of any policy renewal that occurs while any Work is on-going under this Agreement, Fabricator shall provide Nauticus evidence of the insurance coverage required above, including evidence of additional insured status. Failure of Company to demand such evidence or to identify any deficiency in the insurance provided shall not be construed as or deemed to be a waiver of Fabricator's, or its contractors', obligations to maintain the above insurance coverages.

10.0 NAUTICUS FURNISHED ITEMS AND INTELLECTUAL PROPERTY

10.1 All items furnished, loaned or bailed by Nauticus hereunder, or purchased, or otherwise acquired by Fabricator for the performance of this Agreement and specifically charged to and paid by Nauticus (collectively, the "Items"), are the property of Nauticus.

10.2 Company and Fabricator acknowledge that during the course of, and as a result of, the performance of the Work by Fabricator for Company, Fabricator or its subcontractors or sub-subcontractors may create or have created certain written materials such as plans, drawings, specifications, books and records, computer files, or other tangible manifestations of Fabricator's efforts related to the Work and ASVs (hereinafter individually or collectively referred to as "Work Product"). Work Product prepared by Fabricator or its subcontractors or sub-subcontractors shall be "works made for hire," and all rights, title and interest to the Work Product, including any and all copyrights in the Work Product, shall be owned by Company when the applicable Work is paid for by Company irrespective of any copyright notices or confidentiality legends to the contrary which may have been placed in or on such Work Product by Fabricator, a subcontractor, sub-subcontractor or any other person. If, for any reason, any part of or all of the Work Product is not considered a work made for hire for Company or if ownership of all right, title and interest in the Work Product shall not otherwise vest in Company, then Fabricator agrees that such ownership and copyrights in the Work Product, whether or not such Work Product is fully or partially complete, shall be automatically assigned from Fabricator to Owner without further consideration, and Company shall thereafter own all right, title and interest in the Work Product, including all copyright

NAUTICUS ROBOTICS

www.nauticusrobotics.com
{02032936; 1}

17146 FEATHERCRAFT LANE, SUITE 450
WEBSTER, TX 77598
(281) 942-9069

interests. However, Fabricator's Background Intellectual Property (as defined below) that is included in the Work or used to create or operate the Work shall continue to be owned by Fabricator, and Fabricator shall continue to own all copyrights and other rights in the Fabricator's software that is included in the Work or used to create or operate such Work; provided that with respect to such Fabricator's Background Intellectual Property and subcontractor's Background Intellectual Property that is included in the Work or used to create or operate the Work, Fabricator hereby grants Company an irrevocable, perpetual and royalty-free license (including with right to assign its rights without consent to any purchaser of an interest in all or part of the Work or Company's assets) to use, modify and copy such Fabricator's Background Intellectual Property and subcontractor's Background Intellectual Property solely for the fabrication and operation of ASVs (the "ISE License"). All subcontracts and sub-subcontractors shall contain provisions consistent with this section 10.2.

10.3 All information, documentation and other sources of intellectual property provided by Company shall remain the property of Company and Fabricator hereby waives and releases any claim to ownership, license, or rights to Company's intellectual property and the Work Product (subject however to the ISE License).

10.4 "Background Intellectual Property" means property and the legal right therein of either or both parties developed before or independent of this Agreement including inventions, patent applications, patents, copyrights, trademarks, mask works, trade secrets and any information embodying proprietary data such as technical data and computer software. Both parties agree to provide the Background Intellectual Property necessary to complete the Work. Both parties shall retain all rights to their respective Background Intellectual Property provided for this purpose. Neither party shall assume any rights in the other party's Background Intellectual Property provided for this project other than the right to use such Background Intellectual Property to perform the Work and for use in the ASV's. Any conflict between any other provision of this Agreement and this section 10.4 shall be controlled by this section 10.4; provided that the granting of the ISE License as set forth in section 10.2 shall control.

11.0 MONTHLY REPORTING

Fabricator shall provide a Monthly Progress Report no later than ten (10) days after the end of each month, which shall be submitted with the invoice for such month, and the Monthly Progress Report shall cover activities up through the end of the previous month. Fabricator shall provide Company with information related to the total costs spent on the Work broken into categories as approved by Company, costs spent in the most recent month, estimated costs to complete the ASVs, scheduled activities for the next month, schedule delays, if any, estimated completion of each ASV, and any other relevant information as requested by Company.

12.0 INDEMNITY

FABRICATOR SHALL, TO THE FULLEST EXTENT PERMITTED BY APPLICABLE LAW, INDEMNIFY, DEFEND, PROTECT AND HOLD HARMLESS THE COMPANY, ALL SUBSIDIARY OR PARENT COMPANIES OF COMPANY, COMPANY REPRESENTATIVES, AGENTS, ENGINEERS, AND ALL OF THE FOREGOING PARTIES' EMPLOYEES, PARTNERS, MEMBERS, STOCKHOLDERS, OFFICERS AND DIRECTORS AND THEIR RESPECTIVE HEIRS, EXECUTORS, ADMINISTRATORS, SUCCESSORS AND ASSIGNS (COLLECTIVELY, THE "COMPANY PARTIES", AND EACH A "COMPANY PARTY") FROM AND AGAINST ANY CLAIMS, DEMANDS, DEBTS, CAUSES OF ACTION, LIABILITIES, LOSSES, DAMAGES, COSTS, EXPENSES, INCLUDING ACTUAL ATTORNEYS' FEES, AWARDS, COURT COSTS, PENALTIES, FINES OR JUDGMENTS (COLLECTIVELY, "CLAIMS"), RESULTING FROM OR ARISING OR ALLEGED TO HAVE ARISEN OUT OF: (1) BODILY INJURY OR DEATH OF ANY PERSON OR DAMAGE TO PROPERTY, INCLUDING LOSS OF USE OF SUCH PROPERTY, ARISING OUT OF THIS AGREEMENT OR FABRICATOR'S PERFORMANCE OF THE WORK OR OTHER ACTIVITIES OF FABRICATOR, BUT ONLY TO THE EXTENT CAUSED IN WHOLE OR IN PART BY ANY FAULT, NEGLIGENT ACT OR OMISSION OF THE FABRICATOR, ANY OF ITS SUBCONTRACTORS, ANY OF THEIR SUB-SUBCONTRACTORS OR ANYONE DIRECTLY OR INDIRECTLY EMPLOYED BY ANY OF THE FOREGOING PARTIES OR ANYONE FOR WHOSE ACTS

NAUTICUS ROBOTICS

www.nauticusrobotics.com
{02032936; 1}

17146 FEATHERCRAFT LANE, SUITE 450
WEBSTER, TX 77598
(281) 942-9069

SUCH PARTIES MAY BE LIABLE; (2) ACTUAL OR ALLEGED FAILURE OF FABRICATOR OR ITS SUBCONTRACTORS OR SUB-SUBCONTRACTORS TO COMPLY WITH APPLICABLE LAW, APPLICABLE CODES AND STANDARDS OR SAFETY REQUIREMENTS UNDER THIS AGREEMENT; (3) ACTUAL OR ASSERTED VIOLATION OR INFRINGEMENT OF ANY DOMESTIC OR FOREIGN PATENTS, COPYRIGHTS OR TRADEMARKS OR OTHER INTELLECTUAL PROPERTY, OR ANY IMPROPER USE OF CONFIDENTIAL INFORMATION OR OTHER PROPRIETARY RIGHTS THAT MAY BE ATTRIBUTABLE TO FABRICATOR OR ANY SUBCONTRACTOR OR SUB-SUBCONTRACTOR IN CONNECTION WITH THE WORK; (4) ACTUAL OR ALLEGED CONTAMINATION OR POLLUTION ARISING OUT OF ACTS OR OMISSIONS OF FABRICATOR'S OR ANY SUBCONTRACTOR'S OR SUB-SUBCONTRACTOR'S USE, HANDLING OR DISPOSAL OF HAZARDOUS MATERIALS; (5) FAILURE OF FABRICATOR TO MAKE PAYMENTS TO ANY SUBCONTRACTOR IN ACCORDANCE WITH THE RESPECTIVE SUBCONTRACT; OR (6) ANY AND ALL LIENS, STOP NOTICES AND CHARGES OF EVERY TYPE, NATURE, KIND OR DESCRIPTION WHICH MAY AT ANY TIME BE RECORDED AGAINST THE WORK, OR ANY PORTION THEREOF, AS A CONSEQUENCE OF ACTS OR OMISSIONS OF THE FABRICATOR, THE FABRICATOR'S AGENTS, SERVANTS, EMPLOYEES, SUBCONTRACTORS, SUB-SUBCONTRACTORS OR ANY OR ALL OF THEM.

13.0 INDEPENDENT CONTRACTOR

Fabricator is an independent contractor in all respects with regard to this Agreement. Nothing contained in this Agreement shall be deemed or construed to create a partnership, joint venture, agency, or other relationship with Nauticus other than that of independent contractor and customer. Fabricator shall be responsible for compliance with all laws applicable to its employees, including, but not limited to, payment of wages, overtime, social security contributions, worker's compensation, and all other employment, labor, or benefits related laws. Fabricator personnel performing work under this Agreement shall not for any purpose be considered employees or agents of Nauticus nor do Fabricator or Fabricator's personnel have any rights under any benefit plans of Nauticus.

14.0 GOVERNING LAW

This Agreement shall be governed by and construed in accordance with the laws of the State of Texas, USA, excluding its conflict of laws principles. The parties irrevocably agree that venue for all disputes and litigation under this Agreement shall be in either the federal or state courts located in Houston, Harris County, Texas and hereby irrevocably and unconditionally waive any defense of an improper venue or inconvenient forum to the maintenance of any action or proceeding in any such court, any objection to venue with respect to any such action or proceeding and any right of jurisdiction on account of the place of residence or domicile of any party thereto. In the event that any suit or action is instituted under or in relation to this Agreement, including without limitation to enforce any provision in this Agreement, the prevailing party in such dispute shall be entitled to recover from the non-prevailing party, in addition to all other damages allowed by law, all fees, costs and expenses of enforcing any right of such prevailing party under or with respect to this Agreement, including without limitation, such reasonable fees and expenses of attorneys, which shall include, without limitation, all fees, costs and expenses of appeals.

14.1 Notwithstanding any other provision of this Agreement, neither Fabricator nor the Company shall be liable to the other under this Agreement or any cause of action related to the subject matter of this Agreement for loss of profits, loss of business, loss of revenue, loss of use, loss of opportunity, loss of goodwill, business interruption, or any other indirect or consequential damages or loss arising out of this Agreement; provided that the limitation of liability set forth in this section 14.1 shall not apply: (i) to Fabricator's indemnification obligations under this Agreement for Third Party Claims (as defined below); (ii) to any consequential or indirect damages that are covered by any insurance required to be obtained and maintained by Fabricator; or (iii) to a breach of any confidentiality obligations pursuant to section 19. "Third Party Claims" means claims made by a Person that is not a Company Party. "Person" has the meaning given in Tex. Gov't Code § 311.005.

14.2 FABRICATOR'S LIABILITY SHALL NOT EXCEED IN THE AGGREGATE THE TOTAL AMOUNT PAID BY THE COMPANY UNDER THIS AGREEMENT; PROVIDED THAT

NAUTICUS ROBOTICS

www.nauticusrobotics.com
{02032936; 1}

17146 FEATHERCRAFT LANE, SUITE 450
WEBSTER, TX 77598
(281) 942-9069



NOTWITHSTANDING THE FOREGOING, THE LIMITATION OF LIABILITY SET FORTH IN THIS SECTION 14.2 SHALL NOT APPLY (I) TO FABRICATOR'S INDEMNIFICATION OBLIGATIONS UNDER THIS AGREEMENT FOR THIRD PARTY CLAIMS; (II) TO FABRICATOR'S OBLIGATIONS UNDER SECTION 19 OR (III) IN THE EVENT OF FABRICATOR'S FRAUD, WILLFUL MISCONDUCT (INCLUDING THE WILLFUL REFUSAL TO PERFORM THE WORK, WILLFUL DELAY IN PERFORMING THE WORK OR ABANDONMENT OF THE WORK) OR GROSS NEGLIGENCE. FABRICATOR'S LIABILITY SHALL BE REDUCED BY ANY TAX BENEFITS ACTUALLY REALIZED BY A COMPANY PARTY IN RESPECT OF THE CLAIM, AND BY ANY INSURANCE PROCEEDS AND ANY INDEMNITY, CONTRIBUTION, OR OTHER SIMILAR PAYMENT ACTUALLY RECEIVED BY A COMPANY PARTY IN RESPECT OF THE CLAIM LESS REASONABLE COSTS INCURRED BY A COMPANY PARTY FOR SUCH RECEIPT. FABRICATOR SHALL NOT BE LIABLE FOR CLAIMS IN RESPECT OF THIRD-PARTY COMPONENTS AND ITEMS (INCLUDING SOFTWARE) PROVIDED, DESIGNED, OR SPECIFICALLY REQUIRED BY COMPANY.

15.0 COMPLIANCE WITH LAW

Fabricator agrees to comply with, and the Work shall be performed in accordance with, the applicable provisions of any Canadian federal, provincial or local law or ordinance and all orders, rules and regulations issued thereunder.

16.0 EXPORT CONTROL COMPLIANCE

Fabricator shall comply with all applicable U.S. export laws and regulations, including International Traffic in Arms Regulations ("ITAR") and the Export Administration Regulations ("EAR") (the ISE Export Contractor costs will be invoiced as material).

17.0 TERMINATION FOR CONVENIENCE

Nauticus shall have the right to terminate this Agreement, in whole or in part, at any time, without cause, by providing seven days' prior written notice to Fabricator. Upon such termination for convenience, Fabricator shall be entitled, and Company shall be liable solely for (a) all Work performed up to the date of termination, and (b) all costs payable to Fabricator's subcontractors and suppliers. Without limiting the preceding sentence, Fabricator shall ensure that all subcontracts and sub-subcontracts shall contain identical termination for convenience provisions for the protection of Nauticus. Fabricator shall settle all outstanding liabilities and terminate all outstanding subcontracts and supply contracts, and the costs thereof shall be paid by Nauticus. Nauticus shall in no event be liable or responsible to pay Fabricator, or any subcontractor or sub-subcontractor, for any lost profits, consequential damages or any wages for Work not performed.

18.0 NON-WAIVER OF RIGHTS

The failure of either party to insist upon strict performance of any of the terms and conditions in the Agreement, or to exercise any rights or remedies, shall not be construed as a waiver of its rights to assert any of the same or to rely on any such terms or conditions at any time thereafter. The invalidity in whole or in part of any term or condition of this Agreement shall not affect the validity of other parts hereof.

19.0 CONFIDENTIAL OBLIGATIONS

The parties agree to abide by the confidential and nondisclosure obligations set forth the Mutual Confidential Disclosure Agreement executed by the parties and dated January 3, 2022 ("Nondisclosure Agreement"). The parties agree that the terms set forth in the Nondisclosure Agreement are hereby incorporated herein as if set forth in full.

20.0 ASSIGNMENT

Fabricator may not assign or delegate its rights and obligations hereunder without the Company's prior written consent. However, ownership of at least a majority shareholding interest in Fabricator or ownership of substantially all of Fabricator's assets, may be transferred without the Company's consent to

NAUTICUS ROBOTICS

www.nauticusrobotics.com
{02032936; 1}

17146 FEATHERCRAFT LANE, SUITE 450
WEBSTER, TX 77598
(281) 942-9069



a third party if the third party assumes ownership expressly subject to all of the rights and obligations of Fabricator in this Agreement. Any purported assignment, sale, transfer, delegation or other disposition of such rights or obligations by Fabricator, except as permitted herein, shall be null and void. Subject to the foregoing, this Agreement shall be binding upon and shall inure to the benefit of the parties and their respective successors and permitted assigns.

21.0 ORDER OF PRECEDENCE

This Agreement and all of the exhibits, schedules and documents attached hereto are intended to be read and construed in harmony with each other, but in the event of an inconsistency or conflict between provisions of this Agreement, the inconsistency or conflict shall be resolved by giving precedence in the following order:

This Agreement

Attachment I: Statement of Work and Schedule – Aquanaut Project, as it is agreed to from time to time by Company and Fabricator

22.0 NO THIRD-PARTY BENEFICIARIES

The terms and provisions of this Agreement are intended solely for the benefit of each party and their respective successors and permitted assigns, and the parties do not confer third party beneficiary rights upon any other entity or person.

23.0 HEADINGS

The headings in this agreement are for convenience only and will not affect the interpretation of this agreement.

24.0 EXECUTION

This Agreement may be executed in counterparts, each of which so executed will be deemed to be an original and such counterparts together will constitute one and the same agreement. Execution and delivery of this Agreement by exchange of facsimile copies bearing the facsimile signature of a party shall constitute a valid and binding execution and delivery of this Agreement by such party.

25.0 ENTIRE AGREEMENT

The parties agree that this Agreement and the Nondisclosure Agreement shall constitute the entire agreement and understanding between the parties hereto and shall supersede and replace any and all prior or contemporaneous representations, agreements or understandings of any kind, whether written or oral, relating to the subject matter hereof. The Introduction paragraphs on page 1 are an integral part of this Agreement.

By Fabricator's signature of this Agreement, Fabricator also certifies that the organization or any of its Principals are not presently debarred, suspended, proposed for debarment or declared ineligible for the award of contracts by any Federal agency. In the event the Fabricator is proposed or debarred by any Federal agency during the performance term of this Agreement, Fabricator shall notify the Nauticus contractual representative immediately in writing.

26.0 SURVIVAL

The provisions of Sections 7, 9, 10, 12, 14 and 19 shall survive any termination of this Agreement.

[Signature Page Follows]

NAUTICUS ROBOTICS

www.nauticusrobotics.com
{02032936; 1}

17146 FEATHERCRAFT LANE, SUITE 450
WEBSTER, TX 77598
(281) 942-9069



IN WITNESS WHEREOF, the parties have caused this Agreement to be executed and delivered by their respective duly authorized representatives as of the date first above written.

**INTERNATIONAL SUBMARINE
ENGINEERING LTD.:**

NAUTICUS ROBOTICS, INC.

DocuSigned by:
Lara Smith
0F4B0CD015A144E...
(Signature)

Name: Lara Smith
Title: Chief Executive Officer
Date: 1/31/2022

DocuSigned by:
Reginald B. Berka
866D8E706D944F4...
(Signature)

Name: Reginald B. Berka, Ph.D
Title: Chief Operating Officer
Date: January 31, 2022

NAUTICUS ROBOTICS

www.nauticusrobotics.com
{02032936; 1}

17146 FEATHERCRAFT LANE, SUITE 450
WEBSTER, TX 77598
(281) 942-9069



ATTACHMENT 1 – STATEMENT OF WORK

The Statement of Work and Schedule – Aquanaut Project: as it is agreed to from time to time by Company and Fabricator.

NAUTICUS ROBOTICS

www.nauticusrobotics.com
{02032936; 1}

17146 FEATHERCRAFT LANE, SUITE 450
WEBSTER, TX 77598
(281) 942-9069

ATTACHMENT II



1734 Broadway Street, Port Coquitlam, BC, V3C 2M8
 Canada Tel: +1 604-942-5223 Fax: +1 604-942-7577
 www.ise.bc.ca info@ise.bc.ca

1. Rates	Onsite		Offsite			
	Hourly		Hourly		Daily (12 hours)	
	CAD	USD	CAD	USD	CAD	USD
Senior Engineer / Senior Specialist	[REDACTED]					
Engineer / Specialist	[REDACTED]					
Technologist / Technician / Designer / QC/QA	[REDACTED]					
Purchasing / Administration	[REDACTED]					

Onsite rate applies to work at International Submarine Engineering Ltd.'s facility in Port Coquitlam, BC and onboard the *Researcher* in Indian Arm, BC only.

Above rates are valid for weekdays (excluding Canadian statutory holidays) only. Hourly rates shown are for first 8 hours at straight time only. Refer to Items 2-5 below.

1. Travel Days

Door to door charge at hourly rates

2. Week Days

First 8 hours at hourly rates

Overtime will be at 1.5 times the hourly rate after 8 hours

3. Weekends

8 hours minimum charge

Overtime rate of 1.5 times the hourly rate applies to all Weekend time

4. Weekend Standby Days

8 hours charged at hourly rates

5. Travel

All out of pocket meals and incidentals will be based on the Treasury Board of Canada Secretarial - National Joint Council (NJC) rates that are in effect during the dates of the travel

[REDACTED]

6. Offshore Days

Additional 15% will be applied to offshore days which include an overnight stay onboard

Standby days do not apply offshore

7. Materials

[REDACTED]

RATES IN EFFECT 01 DEC 2021 - completion of agreement

RATES SUBJECT TO CHANGE IN THE EVENT OF CURRENCY FLUCTUATIONS OF 10% OR GREATER PLEASE CONTACT YOUR PROJECT MANAGER DIRECTLY FOR RATES AFTER THIS DATE

NAUTICUS ROBOTICS

www.nauticusrobotics.com
 {02032936; 1}

17146 FEATHERCRAFT LANE, SUITE 450
 WEBSTER, TX 77598
 (281) 942-9069

SR211201

CERTAIN IDENTIFIED INFORMATION HAS BEEN EXCLUDED FROM THIS EXHIBIT BECAUSE IT IS BOTH NOT MATERIAL AND IS THE TYPE THAT THE REGISTRANT TREATS AS PRIVATE OR CONFIDENTIAL.

DocuSign Envelope ID: EC43D907-A7D6-492E-9DB8-7C8E6B758859

DIVERSE · MARINE

COWES · ISLE OF WIGHT

AGREEMENT FOR THE CONSTRUCTION OF A NEW VESSEL

'Hydronaut 2', Diverse Marine 18m Hydronaut Class

Reference YARD NUMBER DM-2341

THIS DOCUMENT IS INTENDED TO CREATE A LEGALLY BINDING CONTRACT. BEFORE SIGNING IT YOU ARE ADVISED TO TAKE INDEPENDENT LEGAL ADVICE AND FOLLOWING SUCH ADVICE, IF NECESSARY, TO AMEND THE TERMS TO REFLECT THE TERMS THE PARTIES WISH TO AGREE.

Build Number: DM-2341
This Agreement is made on the 14th February 2022

BETWEEN

- 1) Diverse Marine Ltd. a limited company registered in England (registered address Castle Court, 1 Castle Street, Portchester, Fareham, Hampshire, PO16 9QD; registration Number GB 11377970) whose manufacturing address is Medina Yard, Pelham Road, Cowes, Isle of Wight, PO31 7PG (known as "the Builder")

AND

- 2) Nauticus Robotics. a public company incorporated and registered in the United States of America (registration number 0801963930) whose principal place of business is 17146 Feathercraft Lane, Webster, Texas TX77598 (known as "the Purchaser")

1. Agreement and Specification of the Vessel

- 1.1 The Builder agrees to construct, and the Purchaser agrees to buy the boat which is described in the Specification set out in Annex 1 (the "Specification") to include the Acceptance KPI's, and any drawings and plans, (the "Boat") and in accordance with the terms of this Agreement.
- 1.2 The Specification and any drawings and plans shall be signed by the Parties.
- 1.3 If there is any inconsistency between the drawings and plans on the one hand and the Specification on the other, the Specification shall prevail. If there is any inconsistency between the Specification and this Agreement, the terms of this Agreement shall prevail.
- 1.4 The Vessel shall be constructed, surveyed, tested and delivered in compliance with the applicable laws, rules, regulations and requirements of the Classification Society and the Regulatory Authorities. All costs, fees and charges incidental to and in respect of compliance with the applicable laws, rules, regulations and requirements of the Classification Society or Regulatory Authorities referred to above shall be for the Builder's cost and expense.

2. Modifications and changes to the Specification

- 2.1 The Builder may make minor changes to the Specification, which do not adversely affect the Boat's performance or the requirements of the classification society or regulatory authorities and will consult with the Purchaser on such changes which shall not be unreasonably withheld or delayed but, otherwise, no modifications or changes to the Specification, Delivery Date or Contract Price shall be binding on the Parties unless and until they have been set out in writing and signed by the Parties or its authorised representatives.
- 2.2 The Builder shall have the right to decline any modification or change to the Specification or plans requested by the Purchaser after the signing of this Agreement except for reasonable, minor changes improving or simplifying the build which will be fairly considered and discussed on their merits by both parties.

DM.  NR. 

British Marine Federation BM6-2017 Standard Agreement for the Construction of a New Boat

1 of 17

DIVERSE · MARINE

COWES · ISLE OF WIGHT

3. Contract Price and Payment

- 3.1 The price of the Boat is the Contract Price set out in Annex 2 together with the cost of any extras, modifications or changes to the Specification agreed between the Parties after the date of this Agreement and, if applicable, VAT.
- 3.2 The Purchaser agrees to pay the Contract Price by instalments as set out in Annex 2 and as provided in this Agreement.
- 3.3 The Builder shall give the Purchaser seven (7) days' notice of the anticipated date of completion of each stage of construction as provided in Annex 2. On achievement of stage completion, the Purchaser shall certify that the stage has been satisfactorily completed (the "Stage Certificate"), such certification not to be unreasonably withheld, whereupon the relevant stage payment will become due and payable in full without discount, deduction or set off seven days from such date.
- 3.4 The Contract Price shall not be subject to any increase, except for modifications or changes agreed between the Parties or a change in the rate of VAT. Such modifications to be charged at a fixed labour rate of £40 per hour and materials and consumables to be charged at cost plus 10%.
- 3.5 If the Contract Price is increased in accordance with Clause 3.4, the Builder shall be entitled to require payment of that increase in the Contract Price by way of increase of one or more of the remaining Stage Payments.

4. Unpaid Instalments

- 4.1 If the Purchaser fails to pay the full amount of any Stage Payment or other sum due to the Builder on the due date, the Builder shall be entitled to stop construction of the Boat until all outstanding sums due to the Builder have been paid in full, and the Delivery Date shall be extended by the period of the delay in payment.
- 4.2 If the Purchaser's failure to pay any sums due to the Builder continues for fourteen (14) days after the due date, the Builder shall be entitled to charge interest at one percent (1%) over the Bank of England base rate, calculated from the dates upon which the payments were due.
- 4.3 After a further period of twenty eight (28) days' delay, the Builder shall, without affecting any of its other rights, be entitled:
- 4.3.1 to require immediate payment from the Purchaser of the full balance of the Contract Price then remaining (including any interest earned under Clause 4.2 above) and to complete the construction of the Boat; or, as a last resort after exhausting all other options:
- 4.3.2 to terminate this Agreement and to sell the Boat pursuant to Clause 10.2;
- 4.4 Legitimate non-payment by the Purchaser caused by lack of progress under Clause 3.3.1.1 does not permit the Builder to invoke any perceived rights that might otherwise be applicable under this clause

5. Acceptance Trial and Delivery

- 5.1 The Boat shall be completed and ready for Delivery at the place and on the date stated in Annex 3 or on such later date as may be determined in accordance with the terms of this Agreement (the "Delivery Date").
- 5.2 Unless otherwise agreed between the Parties, the Boat shall, at the Builder's expense, be taken on a trial trip before Delivery (the "Acceptance Trial"). The Builder shall give the Purchaser at least fourteen (14) days' written notice of the date, place and approximate duration of the Acceptance Trial. If the

DIVERSE · MARINE

COWES · ISLE OF WIGHT

date is not convenient to the Purchaser, the Parties will agree an alternative date not more than one (1) week after the date initially proposed by the Builder.

- 5.3 If any defects in workmanship or materials or deviations from the Specification are found during the Acceptance Trial then the Builder shall rectify them without delay and shall carry out a further Acceptance Trial following the procedure set out in Clause 5.2.
- 5.4 If the Purchaser fails to attend the first Acceptance Trial, the Builder shall carry out a further Acceptance Trial following the procedure set out in Clause 5.2.
- 5.5 If the Purchaser fails to attend the second (or any subsequent) Acceptance Trial and the Parties fail to agree an alternative date for a subsequent Acceptance Trial, the Builder may certify to the Purchaser in writing that a satisfactory Acceptance Trial is deemed to have taken place (the "Acceptance Certificate").
- 5.6 At the satisfactory conclusion of an Acceptance Trial, the Purchaser shall sign the Certificate of Delivery and Acceptance in the form provided in Annex 4. The final balance of the Contract Price shall become due and payable immediately upon signature of the Certificate of Delivery and Acceptance or upon provision by the Builder to the Purchaser of the Acceptance Certificate referred to in Clause 5.5 or upon the Purchaser's wrongful failure or refusal to sign the Certificate of Delivery and Acceptance (the "Acceptance"). The Acceptance Certificate signature date is the date for calculation under Annex 3.
- 5.7 From the moment of the Purchaser's signature of the Certificate of Delivery and Acceptance or the Builder's signature of the Acceptance Certificate (as the case may be), the Boat and all its gear and equipment shall be the responsibility and at the risk of the Purchaser, who will be immediately responsible for insuring it.
- 5.8 The Purchaser's signature of the Certificate of Delivery and Acceptance will (save for any matters listed in the Certificate of Delivery and Acceptance) or the Builder's signature of the Acceptance Certificate (as the case may be) constitute evidence that the Boat complied with the Specification at the time of delivery.
- 5.9 The Purchaser shall take Delivery of the Boat upon signature by the Purchaser of the Certificate of Delivery & Acceptance or upon signature by the Builder of the Acceptance Certificate (as the case may be), and immediately upon payment of the final balance of the Contract Price and any other sums owing to the Builder by the Purchaser. If the Purchaser fails to take Delivery of the Boat or fails to pay any outstanding sums due to the Builder without good reason then, in addition to any other rights which the Builder may have, the Builder shall be entitled to require the Purchaser to pay the reasonable berthing and/or storage charges together with any other expenses reasonably incurred by the Builder, including insurance, maintenance and lifting of the Boat in or out of the water until actual delivery shall take place.
- 5.10 Upon Delivery of the Boat the Builder will provide the Purchaser with a Builder's Certificate, a receipted VAT invoice (if applicable) and any other documents listed in Annex 5.
- 5.11 The Purchaser and the Builder expressly agree that the Builder shall not be responsible for investigating or otherwise ensuring that the Purchaser is competent and experienced in the proper control and navigation of the Boat. A list of boat handling and training establishments is available from the Royal Yachting Association.

DM. NR. 

British Marine Federation BM6-2017 Standard Agreement for the Construction of a New Boat

6. Delays and Extensions of Time (Force Majeure)

6.1 The boat is to be delivered by 19th January 2023 (see Annex 3) If construction of the Boat is delayed directly or indirectly due to any cause beyond the Builder's reasonable control then the Delivery Date shall be extended by the period of time during which that delaying cause continues. Force Majeure events are defined as:

1. acts of God;
2. any government requisition, control, intervention, requirement or interference;
3. threat or act of war, warlike operations, terrorism or the consequences thereof;
4. riots, civil commotions, blockades or embargoes;
5. epidemics;
6. earthquakes, landslides, floods, tidal waves or extraordinary weather conditions;
7. strikes, lockouts or other industrial action, but only if of a general nature and not limited solely to the Builder and/or the Sub-contractors or their employees;
8. fire, accident, explosion (whether in the Shipyard or elsewhere);
9. any interruption to the supply of public utilities to the Builder;
10. any other cause of a similar nature to the above beyond the control of the Builder or its named Sub-contractors;
11. Coronavirus disease (COVID-19) or severe acute respiratory syndrome coronavirus 2 (SARS-CoV-2) or any mutation or variation of the former to cover events outside of the builder's direct control for example delays or cost increases from supply chain and contractors as a direct result of the above.

6.1.1 It is agreed the following events are not to be construed as Force Majeure:

- 1) a fire, accident or explosion caused by negligence or mismanagement of the builder
- 2) any interruption to the supply of public utilities to the Builder caused by failure to pay utility bills or through negligence or mismanagement

6.2 The Builder shall give the Purchaser written notice of any event in respect of which the Builder claims to be entitled to an extension of time:

- 6.2.1 within seven (7) days of its commencement, stating the date on which the delay commenced, the cause of it and its estimated duration; and
- 6.2.2 within seven (7) days of its end, stating the date on which it ended and the total period of the extension to the Delivery Date.

6.3 If the Builder's premises, plant, machinery or equipment shall be so damaged by the operation of a delaying cause for which the Builder is not responsible so as to make it impracticable or impossible for the Builder to complete the construction of the Boat in a timely manner, the Builder may, at its option and in any event within twenty one (21) days of the operation of the delaying cause, cancel this Agreement by notice in writing to the Purchaser, whereupon the Purchaser shall be entitled by written election either:

- 6.3.1 to take over and complete the Boat without further liability on the Builder whereupon the Purchaser shall pay to the Builder all sums then due, whether by way of the Stage Payments or otherwise; or
- 6.3.2 to require repayment of all Stage Payments paid by the Purchaser to the Builder up to that date, and upon such repayment, title in the Boat and all materials and equipment appropriated to the Boat shall re-vest in the Builder.

DM. NR. 

British Marine Federation BM6-2017 Standard Agreement for the Construction of a New Boat

7. Access to the Boat and to Builder's Premises

7.1 The Purchaser shall have the right to inspect the progress of construction of the Boat as the Purchaser sees fit which shall include any of the Builder's subcontracted scopes subject to the following conditions:

- 7.1.1 inspections shall take place during the Builder's normal business hours;
- 7.1.2 inspections shall be on reasonable notice –as to the timing, identity and authority of the persons attending – and subject to the consent of the Builder (such consent not to be unreasonably withheld);
- 7.1.3 the Builder shall be entitled to accompany the Purchaser or his representative(s) and require strict observance of the Builder's insurance requirements, Health and Safety policy and other regulatory requirements;
- 7.1.4 access shall extend only to those parts of the Builder's premises necessary for the inspection of the Boat and/or the materials and equipment intended for the Boat; and
- 7.1.5 the length, timing or frequency of such inspections shall not unreasonably interfere with the Builder's construction programme.

7.2 During such inspections and while at the Builder's premises or on the Boat, the Purchaser and his representative(s) shall observe all current rules and regulations applied by and to the Builder and its premises.

8. Warranties

8.1 In addition to the Purchaser's statutory rights, the warranties in Clause 8.2 shall apply.

8.2 Subject to the conditions which are set out at Clause 8.3, the Builder warrants to the Purchaser that the Boat will:

- 8.2.1 be of satisfactory quality and fit for the purpose made known to the Builder prior to the date of this Agreement whether or not such purpose is one for which the Boat is commonly supplied;
- 8.2.2 correspond with the Specification and any agreed variations, additions or modifications to the Specification;
- 8.2.3 be free from defects in materials and workmanship for a period of twelve (12) months from Delivery;
- 8.2.4 comply with all legislative requirements and regulations relating to the sale of the Boat in the UK and European Union for any purpose made known under Clause 8.2.1 above; and
- 8.2.5 comply with any other requirements or regulations which may be agreed between the Parties or its authorised representatives.

8.3 The Purchaser's statutory rights and the warranties set out in Clause 8.2 shall be subject to the following conditions:

DM,  NR 

DIVERSE · MARINE

COWES · ISLE OF WIGHT

- 8.3.1 the Builder shall have no liability for any defect or regulatory non-conformity in the Boat which arises directly as a result of the Builder's adherence to any part of the Specification which is specified, supplied or developed by the Purchaser or his agents;
- 8.3.2 the Builder shall be given the opportunity to repair or replace any defect or deficiency in workmanship, materials or equipment or any failure to conform with the Specification. Such repair or replacement shall be carried out by the Builder at its premises without cost to the Purchaser or, where that is not convenient to the Parties, for example where the vessel is working and the defects are small in nature, with no need to lift the vessel from the water, then the Builder shall travel to the vessel to rectify agreed defects. Where work is carried out away from the Builders premises the travel and accommodation expenses are to be for the Purchasers account. The Builder may decide to pay the reasonable cost of having such work carried out elsewhere by a third party such as one located at the Purchasers base port for the contract that it is on. In this case it is only done with the prior authorisation of the Builder and issuance of a purchase order from the Builder to the nominated contractor. No work will be paid for without a valid purchase order from the Builder;
- 8.3.3 the Purchaser shall notify the Builder in writing as soon as reasonably practicable on discovery of any alleged defect or deficiency and the Builder or its agent shall have the right to inspect the Boat including the right to carry out sea trials to enable the Builder or its agent to examine or assess the extent of the alleged defect or deficiency. The expense of any such trials shall be borne by the Builder if the defect is shown to be one of workmanship or materials.

9. Insurance

- 9.1 The Builder shall insure the Boat (together with all equipment and materials installed or intended for it and within the Builder's premises including the equipment 'free issued' by the Purchaser) from the date of this Agreement until the date of Delivery, noting, insofar as possible, the Purchaser's interest in the Boat. Please also see Clause 22.
- 9.2 Such insurance shall be effected with a reputable insurer for a sum equal to the replacement cost of the completed Boat (to a value of £3.25million inclusive of the free issued items) and shall include the cost of any additions or variations to the Specification which have been agreed between the Parties.
- 9.3 Such insurance shall be on terms no less favourable than the Institute Clauses for Builder's Risks published by the Institute of London Underwriters, as applicable from time to time. Documentary evidence of such insurance, its terms and conditions and proof of payment of the premium shall be provided to the Purchaser on request.
- 9.4 In the event that the Boat, equipment or materials sustain damage at any time before Delivery, any monies received in respect of the insurance shall be receivable by the Builder and shall be applied by it in making good such damage in a reasonable and workmanlike manner and the Delivery Date shall be extended by such period as shall be reasonably necessary to affect the necessary repairs. The Purchaser shall not be entitled to reject the Boat, equipment, or materials on account of such damage or repairs or to make any claim in respect of any resultant depreciation. If the Boat is declared an actual or constructive total loss the Purchaser shall have the option, to be exercised within twenty-eight (28) days of the loss, of cancelling this Agreement in which event the insurance money to the value of Stage Payments already paid shall be paid direct to the Purchaser by the insurers and the Purchaser will abandon all rights under the said insurance to the Builder. This Agreement will then terminate in all respects as if it had been duly completed and the Purchaser shall have no further right to claim against the Builder.

DM. NR. 

British Marine Federation BM6-2017 Standard Agreement for the Construction of a New Boat

10. Termination

- 10.1 Either Party shall be entitled to terminate this Agreement by written notice if:
- 10.1.1 the other Party becomes insolvent or initiates or becomes subject to any formal insolvency procedure or, in the case of an individual, is declared bankrupt or makes any arrangement with or for the benefit of their creditors.
 - 10.1.2 the other Party has breached a fundamental term of this Agreement and has been given written notice of the need to correct the breach but has failed to do so within twenty eight (28) days of that written notice and has not referred the matter to dispute resolution under the provisions of Clauses 18 and 0.
- 10.2 If the Builder exercises its right to terminate this Agreement under this Clause 10, title to the Boat shall pass to the Builder and the Builder shall be entitled to sell the Boat, the materials and the equipment and/or any other property of the Purchaser in the possession of the Builder for the purpose of the construction of the Boat. The Builder shall give the Purchaser twenty-eight (28) days' written notice of its intention to sell the Boat and/or other property and such notice shall give details of the reasons for the sale including details of any sums due and payable to the Builder together with details of the proposed method of sale. Following the sale of the Boat and/or other property the Builder shall repay to the Purchaser the balance of the proceeds of sale after deduction of all sums owing to the Builder and all reasonable legal or other expenses including, but not limited to, the costs of sale and maintenance and storage charges incurred by the Builder.
- 10.3 Where this Agreement is governed by English law, in addition to any other rights contained in this Agreement, the provisions of the Torts (Interference with Goods) Act 1977 (the "Act") shall apply in relation to an uncollected Boat and/or other property. This Act confers a Right of Sale on the Builder in circumstances where the Purchaser fails to collect or accept delivery of goods (which includes the Boat and any other property). Such sale will not take place until the Builder has given notice to the Purchaser in accordance with the Act. For the purpose of the Act it is recorded that:
- 10.3.1 the Builder's obligation to the Purchaser as custodian of the Boat and other property ends on the expiry or termination of this Agreement.
 - 10.3.2 the place for Delivery and collection of the Boat shall be at the Builder's premises.
- 10.4 The Purchaser shall co-operate with the Builder insofar as may be necessary to affect a sale of the Boat including signing or confirming any authority or instructions.
- 10.5 Termination under this Clause 10 shall not affect any other rights or remedies which the Parties may have.
- 10.6 All 'free issued' items by the Purchaser will remain the property of the Purchaser, be marked with the Purchaser's name and be returned in the event of Builders insolvency. See also Clause 22.

DIVERSE · MARINE

COWES · ISLE OF WIGHT

10.7 The Purchaser shall have the right to terminate this Contract forthwith upon giving notice in the event that: the Builder fails to perform any work relating to the construction of the Vessel for a running period of at least 30 days. If this Contract is terminated by the Purchaser, the Builder shall release the Purchaser from the obligations of this Contract upon payment of the next non-issued Stage Payment Installation (invoice to be raised by the Builder without delay) as provided in Annex 2. On the Builders receipt of payment, the Builder shall release the Purchaser from the claim provided in Clause 11.1 and all materials, gear or equipment bought or appropriated to the Agreement can be collected within 5 working days. Storage costs will be charged beyond this date and be paid prior to collection.

11. Ownership of the Boat

11.1 The Boat and/or all materials and equipment purchased or appropriated from time to time by the Builder specifically for its construction (whether in its premises, upon the water or elsewhere) shall become the property of the Purchaser upon payment to the Builder of the 1st Stage Payment. As and from that date, title in additional materials, gear and equipment bought for or appropriated to the Agreement shall pass to the Purchaser upon such purchase or appropriation. The Builder shall, however, have a claim (known as a "lien") over and be entitled to retain possession of the Boat and any materials or equipment purchased for or appropriated to the construction until it has received full payment of all sums due to it under this Agreement and any variations, whether invoiced or not excluding those free issued items supplied by the Purchaser. Title in any materials or equipment rejected by the Purchaser or otherwise not used in construction of the Boat shall immediately pass back to the Builder.

11.2 The Builder shall, so far as it is reasonably practicable to do so, mark all individual items of equipment and materials which are purchased for or appropriated to the construction of the Boat.

11.3 The Purchaser shall not without the prior written consent of the Builder (which shall not be unreasonably withheld) sell, assign, pledge or otherwise charge this Agreement or any rights arising under it, or the Boat itself by way of security for any indebtedness prior to Delivery except for the sole purpose of obtaining a loan to finance the construction of the Boat. If the Purchaser charges the Boat in breach of the terms of this Clause 11.3, the full balance of the Contract Price shall become immediately due and payable without affecting any other rights or remedies of the Builder.

12. Consumer Rights



12.1 If:

12.1.1 the Builder is acting in the course of his/her trade;

12.1.2 the Purchaser is a consumer for the purposes of the Consumer Contract (Information, Cancellation and Additional Charges) Regulations 2013; and

12.1.3 this Agreement is a distance or off-premises contract for the purposes of the Consumer Contract (Information, Cancellation and Additional Charges) Regulations 2013,

the Purchaser may be entitled to cancel this Agreement within fourteen (14) days from the day on which the Purchaser acquires physical possession of the Boat (the "Cancellation Period"). If this right to cancel this Agreement is exercised by the Purchaser, the Purchaser shall bear the cost (if any) of transporting and redelivering it to the Builder, as well as any other relevant charges as may be notified to the Purchaser by the Builder. If, as a result of the Purchaser's handling of the Boat, beyond what is necessary to establish the nature, characteristics and functioning of the Boat, the Boat's value is diminished by any amount, the Builder may recover that amount (up to the Purchase Price) from the Purchaser.

DM  NR 

British Marine Federation BM6-2017 Standard Agreement for the Construction of a New Boat

8 of 17

DIVERSE · MARINE

COWES · ISLE OF WIGHT

13. Third Party Rights

13.1 A person who is not a party to this Agreement shall have no right under the Contracts (Rights of Third Parties) Act 1999 to enforce any term of this Agreement.

14. Copyright

14.1 Any copyright or similar protection in manuals, drawings, or plans, specifications, including the Specification, prepared by the Builder or its employees or agents, shall at all times remain the property of the Builder. Any copyright or similar protection in manuals, drawings or plans including the specification provided by the Purchaser or its chosen vessel designer remain the property of the Purchaser.

15. Notices

15.1 Any notice to be served under this Agreement on either Party shall be in writing and shall be sufficiently served if delivered personally or posted by recorded delivery to the address set out in this Agreement (unless the Party has by written notice to the other Party substituted a different address in England as the notice address). Any posted notice shall be deemed to have been received on the third business day after the time of posting.

15.2 Notices may also be served by e-mail or fax, in which case they shall be deemed received upon despatch if despatch was on a business day in the United Kingdom and within 0900-1700 hours UTC and there was no delivery failure notice. If despatched before 0900 hours UTC on a business day, the notice shall be deemed received at 0900 hours UTC that day. If despatched after 1700 hours UTC on a business day or on any non-business day, the notice shall be deemed received at 0900 hours UTC on the next business day.

Address for notices:

Diverse Marine Ltd
Medina Yard, Pelham Road, Cowes, Isle of Wight, PO31 7PG, United Kingdom
FAO Mr Ben Colman
e-mail: bencolman@diversemarine.co.uk
Tel: +44 1983 300656

Nauticus Robotics

17146 Feathercraft Lane, Webster, TX77598, United States of America
FAO Mr Todd Newell
e-mail: tnewell@nauticusrobotics.com
Tel: +1 832 577 8234

16. Entire Agreement

16.1 This Agreement constitutes the entire agreement between the Parties and supersedes any previous arrangement, understanding or agreement between them relating to the subject matter of the Agreement.

16.2 Each Party acknowledges that, in entering into the Agreement it does not rely on any statement, representation, assurance or warranty of any person (whether a party to the Agreement or not) other than as expressly set out in the Agreement.

16.3 Nothing in this Clause 16 shall limit or exclude any liability for fraud.

16.4 Any variations or alterations to this Agreement must be in writing and signed by the Parties.

DM  NR 
British Marine Federation BM6-2017 Standard Agreement for the Construction of a New Boat
9 of 17

DIVERSE · MARINE

COWES · ISLE OF WIGHT

- 16.5 This Agreement may be executed by the Parties in any number of counterparts, each of which shall be deemed to be an original but all of which taken together shall constitute one and the same instrument and shall become effective when one or more counterparts have been signed by each of the Parties and delivered to the other party.
- 17. Interpretation**
- 17.1 The construction and meaning of this Agreement is not to be affected by any headings.
- 17.2 To the extent that the terms of this Agreement contradict any laws on consumer rights, the rights conferred on any Party who is a consumer shall remain unaffected.
- 17.3 If any provision of this Agreement is deemed for any reason to be invalid, void or deleted, the Agreement shall nonetheless remain in full force and effect as if such provision had not originally been included. In such circumstances, the Parties shall negotiate in good faith in order to agree the terms of a mutually acceptable and satisfactory alternative provision in place of the invalid, void or deleted provision. If such agreement cannot be reached, the Agreement shall remain in full force and effect without such provision.
- 18. Law & Jurisdiction**
- 18.1 If the Purchaser is not a consumer for the purposes of the Consumer Contract (Information, Cancellation and Additional Charges) Regulations 2013:-
- 18.1.1 This Agreement and any non-contractual obligations arising out of, or in connection with, this Agreement shall be governed by and construed in accordance with:
- 18.1.1.1 English law, if the principal place of business of the Builder is in England; or
- 18.1.1.2 Scots law, if the principal place of business of the Builder is in Scotland.
- 18.2 If the Purchaser is a consumer for the purposes of the Consumer Contract (Information, Cancellation and Additional Charges) Regulations 2013:-
- 18.2.1 This Agreement and any non-contractual obligations arising out of, or in connection with, this Agreement shall be governed by and construed in accordance with:
- 18.2.1.1 English law, if the principal place of residence of the Purchaser is in England; or
- 18.2.1.2 Scots law, if the principal place of residence of the Purchaser is in Scotland.
- 18.3 Subject to Clause 19. below, the Parties irrevocably agree that any and every dispute (and any non-contractual obligations, as aforesaid) arising out of or in connection with this Agreement shall be subject to the non-exclusive jurisdiction of the English courts.
- 18.4 A dispute on a technical issue may, with the agreement of both Parties, be referred to a single surveyor who shall be independent of the Parties and whose identity and terms of reference shall be agreed by the Parties or, in default of agreement by the Parties within seven (7) days from receipt of the written notice from one of the Parties for such a referral, a surveyor shall be appointed from an independent Naval Architect, Walker Marine Design Ltd.
- 18.5 A surveyor appointed or nominated under Clause 18.4 shall act as an expert and not as an arbitrator and his written decision shall be final and binding upon the Parties and his fees and expenses shall be borne equally by the Parties.

DIVERSE · MARINE

COWES · ISLE OF WIGHT

18.6 For the purposes of Clause 18.4, technical issues include, by way of example, whether a Stage Payment is due, the operation or duration of a delaying event, whether for the purposes of the insurance the Boat has suffered damage, and the Boat's conformity with the Specification.

19. Arbitration

19.1 Any dispute arising out of or in connection with this Contract shall be referred to arbitration in London in accordance with the Arbitration Act 1996 or any statutory modification or re-enactment thereof save to the extent necessary to give effect to the provisions of this Clause.

19.2 The arbitration shall be conducted in accordance with the London Maritime Arbitrators Association (LMAA) Terms current at the time when the arbitration proceedings are commenced.

19.3 The reference shall be to three arbitrators. A Party wishing to refer a dispute to arbitration shall appoint its arbitrator and send notice of such appointment in writing to the other Party requiring the other Party to appoint its own arbitrator within fourteen (14) calendar days of that notice and stating that it will appoint its arbitrator as sole arbitrator unless the other Party appoints its own arbitrator and gives notice that it has done so within the fourteen (14) days specified. If the other Party does not appoint its own arbitrator and give notice that it has done so within the fourteen (14) days specified, the Party referring a dispute to arbitration may, without the requirement of any further prior notice to the other Party, appoint its arbitrator as sole arbitrator and shall advise the other Party accordingly. The award of a sole arbitrator shall be binding on both Parties as if he had been appointed by agreement.

19.4 Nothing herein shall prevent the Parties agreeing in writing to vary these provisions to provide for the appointment of a sole arbitrator.

19.5 In cases where neither the claim nor any counterclaim exceeds the sum of £75,000 (or such other sum as the Parties may agree) the arbitration shall be conducted in accordance with the LMAA Small Claims Procedure current at the time when the arbitration proceedings are commenced.

20. Subcontracting

20.1 The Builder may employ the Sub-contractor Aluminium Marine Consultants for fabrication and Boat Electrics & Electronics or electrical/electronic works. Otherwise except for minor work, the Builder shall not employ other sub-contractors without the Purchaser's approval, which shall not be unreasonably withheld. Notwithstanding any sub-contracting, the Builder shall remain fully responsible for the due performance of all such work as if undertaken by the Builder.

21. Reporting

21.1 As soon as possible and not later than ten (10) days after the effective date of the Contract the Builder shall provide the Purchaser with a detailed build timeline. The timeline will be continually updated as the build progresses and issued to the Purchaser on fortnightly basis highlighting any areas of delay or concern.

DM.  NR. 
British Marine Federation BM16-2017 Standard Agreement for the Construction of a New Boat
11 of 17

DIVERSE · MARINE

COWES · ISLE OF WIGHT

22. Free Issue Items

- 22.1 The Builder shall safely store and handle the Purchasers free-issue items after delivery thereof at a warehouse or other storage facility at the Shipyard and shall, at its own cost, expense and responsibility, install them in or on the Vessel in accordance with the Specification, provided that the Builder shall not be responsible for the quality, efficiency and/or performance of any of the items.
- 22.2 The items shall at all times remain the property of the Purchaser but shall be at the Builder's risk from the time of their delivery to the Shipyard until the time of their redelivery to the Purchaser whether or not as part of the Vessel.

DIVERSE · MARINE

COWES · ISLE OF WIGHT



DM.  NR. 
British Marine Federation BM6-2017 Standard Agreement for the Construction of a New Boat
13 of 17

DIVERSE · MARINE

COWES · ISLE OF WIGHT

ANNEX 1

SPECIFICATION

The Specification for the Boat is as set out below or as identified below and attached to this Agreement and signed by the Parties.

Contract Specification Reference & Attached
DM-2341 Vessel Specification Issue A 19-01-22

Contract General Arrangement & Attached:
21021-010101_F 11-11-21

ANNEX 2

AGREEMENT VALUE & STAGE PAYMENT SCHEDULE

Contract Value: [REDACTED] (Great British Pounds)

DM Gratuities:

- o 1 x 1:30 Scale Model

Nauticus Robotics Free Issue Equipment:

- o Kongsberg Launch & Recovery System (LARS) Complete:
 - o Structure
 - o Rails & Track
 - o Winch & Powerpack
 - o Commissioning & Testing
 - o Diverse Marine have allowed to bolt down equipment only
- o Nauticus Robotics Aquanaut
 - o Complete with all Associated Equipment & Charging
- o Aquanaut Control, Monitoring & Autonomy Equipment
- o WiFi Mesh System
- o Cyber Security Hardware & Software Costs
- o Operational Equipment & Anything Not Specifically Mentioned in the Specification

Stage Payment Schedule:

Boat Name		Value	Delivery
Hydraeust 2 (HY2)		[REDACTED]	10/02/2023

Stage Description	%	Value	Indicative Payment	Supporting Information for Payment
Deposit	10%	[REDACTED]	Feb-22	Signed Contract
Completion of Marine Kit Design & Drawing Package	5%	[REDACTED]	Mar-22	Shipyards Declaration Supported by GMD Information
Aluminium Kit Arrival	5%	[REDACTED]	May-23	Shipyards Declaration, Photographs & Quality Certificates
Frames Complete & Keels Standing	15%	[REDACTED]	Jun-23	Shipyards Declaration & Photographs
Hull Structure Complete	25%	[REDACTED]	Oct-23	Shipyards Declaration, Photographs & TRF Quality Form
IPS System Ready to Dispatch	15%	[REDACTED]	Oct-22	Shipyards Declaration & Supporting Golden Arrow Documentation
Installation of IPS System	15%	[REDACTED]	Dec-23	Shipyards Declaration, Photographs & TRF Quality Form
Acceptance	10%	[REDACTED]	Feb-02	Signed Acceptance Certificate

DM [Signature] NR [Signature]^{DS}
 British Marine Federation BM6-2017 Standard Agreement for the Construction of a New Boat
 15 of 17

ANNEX 3

DELIVERY DATE & LATE DELIVERY PENALTIES

Delivery Date: 10th February 2023

A3.1 If delivery takes place more than 30 days after the delivery date then for each day thereafter the Contract Price shall be reduced by the amount GBP600 per day as liquidated damages up to a maximum delay of 90 days (comprising a 30-day grace period plus 60 days). If the delay exceeds 90 days, the Purchaser shall have the option to terminate this Agreement in accordance with Clause 10.1.

DIVERSE · MARINE

COWES · ISLE OF WIGHT

ANNEX 4

CERTIFICATE OF DELIVERY & ACCEPTANCE

TO BE INSERTED

DM  NR ^{DS}
British Marine Federation BM6-2017 Standard Agreement for the Construction of a New Boat
17 of 17

AGREEMENT FOR THE CONSTRUCTION OF A NEW VESSEL

'Hydronaut 3', Diverse Marine 18m Hydronaut Class

Reference YARD NUMBER DM-2342

THIS DOCUMENT IS INTENDED TO CREATE A LEGALLY BINDING CONTRACT. BEFORE SIGNING IT YOU ARE ADVISED TO TAKE INDEPENDENT LEGAL ADVICE AND FOLLOWING SUCH ADVICE, IF NECESSARY, TO AMEND THE TERMS TO REFLECT THE TERMS THE PARTIES WISH TO AGREE.

Build Number: DM-2342
This Agreement is made on the 14th February 2022

BETWEEN

1) Diverse Marine Ltd. a limited company registered in England (registered address Castle Court, 1 Castle Street, Portchester, Fareham, Hampshire, PO16 9QD; registration Number GB 11377970) whose manufacturing address is Medina Yard, Pelham Road, Cowes, Isle of Wight, PO31 7PG (known as "the Builder")

AND

2) Nauticus Robotics. a public company incorporated and registered in the United States of America (registration number 0801963930) whose principal place of business is 17146 Feathercraft Lane, Webster, Texas TX77598 (known as "the Purchaser")

1. Agreement and Specification of the Vessel

1.1 The Builder agrees to construct, and the Purchaser agrees to buy the boat which is described in the Specification set out in Annex 1 (the "Specification") to include the Acceptance KPI's, and any drawings and plans, (the "Boat") and in accordance with the terms of this Agreement.

1.2 The Specification and any drawings and plans shall be signed by the Parties.



1.3 If there is any inconsistency between the drawings and plans on the one hand and the Specification on the other, the Specification shall prevail. If there is any inconsistency between the Specification and this Agreement, the terms of this Agreement shall prevail.

1.4 The Vessel shall be constructed, surveyed, tested and delivered in compliance with the applicable laws, rules, regulations and requirements of the Classification Society and the Regulatory Authorities. All costs, fees and charges incidental to and in respect of compliance with the applicable laws, rules, regulations and requirements of the Classification Society or Regulatory Authorities referred to above shall be for the Builder's cost and expense.

2. Modifications and changes to the Specification

2.1 The Builder may make minor changes to the Specification, which do not adversely affect the Boat's performance or the requirements of the classification society or regulatory authorities and will consult with the Purchaser on such changes which shall not be unreasonably withheld or delayed but, otherwise, no modifications or changes to the Specification, Delivery Date or Contract Price shall be binding on the Parties unless and until they have been set out in writing and signed by the Parties or its authorised representatives.

2.2 The Builder shall have the right to decline any modification or change to the Specification or plans requested by the Purchaser after the signing of this Agreement except for reasonable, minor changes improving or simplifying the build which will be fairly considered and discussed on their merits by both parties.

DM  NR 

British Marine Federation BM6-2017 Standard Agreement for the Construction of a New Boat

DIVERSE · MARINE

COWES · ISLE OF WIGHT

3. Contract Price and Payment

- 3.1 The price of the Boat is the Contract Price set out in Annex 2 together with the cost of any extras, modifications or changes to the Specification agreed between the Parties after the date of this Agreement and, if applicable, VAT.
- 3.2 The Purchaser agrees to pay the Contract Price by instalments as set out in Annex 2 and as provided in this Agreement.
- 3.3 The Builder shall give the Purchaser seven (7) days' notice of the anticipated date of completion of each stage of construction as provided in Annex 2. On achievement of stage completion, the Purchaser shall certify that the stage has been satisfactorily completed (the "Stage Certificate"), such certification not to be unreasonably withheld, whereupon the relevant stage payment will become due and payable in full without discount, deduction or set off seven days from such date.
- 3.4 The Contract Price shall not be subject to any increase, except for modifications or changes agreed between the Parties or a change in the rate of VAT. Such modifications to be charged at a fixed labour rate of £40 per hour and materials and consumables to be charged at cost plus 10%.
- 3.5 If the Contract Price is increased in accordance with Clause 3.4, the Builder shall be entitled to require payment of that increase in the Contract Price by way of increase of one or more of the remaining Stage Payments.

4. Unpaid Instalments

- 4.1 If the Purchaser fails to pay the full amount of any Stage Payment or other sum due to the Builder on the due date, the Builder shall be entitled to stop construction of the Boat until all outstanding sums due to the Builder have been paid in full, and the Delivery Date shall be extended by the period of the delay in payment.
- 4.2 If the Purchaser's failure to pay any sums due to the Builder continues for fourteen (14) days after the due date, the Builder shall be entitled to charge interest at one percent (1%) over the Bank of England base rate, calculated from the dates upon which the payments were due.
- 4.3 After a further period of twenty eight (28) days' delay, the Builder shall, without affecting any of its other rights, be entitled:
- 4.3.1 to require immediate payment from the Purchaser of the full balance of the Contract Price then remaining (including any interest earned under Clause 4.2 above) and to complete the construction of the Boat; or, as a last resort after exhausting all other options:
- 4.3.2 to terminate this Agreement and to sell the Boat pursuant to Clause 10.2;
- 4.4 Legitimate non-payment by the Purchaser caused by lack of progress under Clause 3.3.1.1 does not permit the Builder to invoke any perceived rights that might otherwise be applicable under this clause.

5. Acceptance Trial and Delivery

- 5.1 The Boat shall be completed and ready for Delivery at the place and on the date stated in Annex 3 or on such later date as may be determined in accordance with the terms of this Agreement (the "Delivery Date").
- 5.2 Unless otherwise agreed between the Parties, the Boat shall, at the Builder's expense, be taken on a trial trip before Delivery (the "Acceptance Trial"). The Builder shall give the Purchaser at least fourteen (14) days' written notice of the date, place and approximate duration of the Acceptance Trial. If the

DM. NR. 

DIVERSE · MARINE

COWES · ISLE OF WIGHT

date is not convenient to the Purchaser, the Parties will agree an alternative date not more than one (1) week after the date initially proposed by the Builder.

- 5.3 If any defects in workmanship or materials or deviations from the Specification are found during the Acceptance Trial then the Builder shall rectify them without delay and shall carry out a further Acceptance Trial following the procedure set out in Clause 5.2.
- 5.4 If the Purchaser fails to attend the first Acceptance Trial, the Builder shall carry out a further Acceptance Trial following the procedure set out in Clause 5.2.
- 5.5 If the Purchaser fails to attend the second (or any subsequent) Acceptance Trial and the Parties fail to agree an alternative date for a subsequent Acceptance Trial, the Builder may certify to the Purchaser in writing that a satisfactory Acceptance Trial is deemed to have taken place (the "Acceptance Certificate").
- 5.6 At the satisfactory conclusion of an Acceptance Trial, the Purchaser shall sign the Certificate of Delivery and Acceptance in the form provided in Annex 4. The final balance of the Contract Price shall become due and payable immediately upon signature of the Certificate of Delivery and Acceptance or upon provision by the Builder to the Purchaser of the Acceptance Certificate referred to in Clause 5.5 or upon the Purchaser's wrongful failure or refusal to sign the Certificate of Delivery and Acceptance (the "Acceptance"). The Acceptance Certificate signature date is the date for calculation under Annex 3.
- 5.7 From the moment of the Purchaser's signature of the Certificate of Delivery and Acceptance or the Builder's signature of the Acceptance Certificate (as the case may be), the Boat and all its gear and equipment shall be the responsibility and at the risk of the Purchaser, who will be immediately responsible for insuring it.
- 5.8 The Purchaser's signature of the Certificate of Delivery and Acceptance will (save for any matters listed in the Certificate of Delivery and Acceptance) or the Builder's signature of the Acceptance Certificate (as the case may be) constitute evidence that the Boat complied with the Specification at the time of delivery.
- 5.9 The Purchaser shall take Delivery of the Boat upon signature by the Purchaser of the Certificate of Delivery & Acceptance or upon signature by the Builder of the Acceptance Certificate (as the case may be), and immediately upon payment of the final balance of the Contract Price and any other sums owing to the Builder by the Purchaser. If the Purchaser fails to take Delivery of the Boat or fails to pay any outstanding sums due to the Builder without good reason then, in addition to any other rights which the Builder may have, the Builder shall be entitled to require the Purchaser to pay the reasonable berthing and/or storage charges together with any other expenses reasonably incurred by the Builder, including insurance, maintenance and lifting of the Boat in or out of the water until actual delivery shall take place.
- 5.10 Upon Delivery of the Boat the Builder will provide the Purchaser with a Builder's Certificate, a receipted VAT invoice (if applicable) and any other documents listed in Annex 5.
- 5.11 The Purchaser and the Builder expressly agree that the Builder shall not be responsible for investigating or otherwise ensuring that the Purchaser is competent and experienced in the proper control and navigation of the Boat. A list of boat handling and training establishments is available from the Royal Yachting Association.

DM,  NR 

- 6. Delays and Extensions of Time (Force Majeure)**
- 6.1 The boat is to be delivered by 19th January 2023 (see Annex 3) If construction of the Boat is delayed directly or indirectly due to any cause beyond the Builder's reasonable control then the Delivery Date shall be extended by the period of time during which that delaying cause continues. Force Majeure events are defined as:
1. acts of God;
 2. any government requisition, control, intervention, requirement or interference;
 3. threat or act of war, warlike operations, terrorism or the consequences thereof;
 4. riots, civil commotions, blockades or embargoes;
 5. epidemics;
 6. earthquakes, landslides, floods, tidal waves or extraordinary weather conditions;
 7. strikes, lockouts or other industrial action, but only if of a general nature and not limited solely to the Builder and/or the Sub-contractors or their employees;
 8. fire, accident, explosion (whether in the Shipyard or elsewhere);
 9. any interruption to the supply of public utilities to the Builder;
 10. any other cause of a similar nature to the above beyond the control of the Builder or its named Sub-contractors;
 11. Coronavirus disease (COVID-19) or severe acute respiratory syndrome coronavirus 2 (SARS-CoV-2) or any mutation or variation of the former to cover events outside of the builders direct control for example delays or cost increases from supply chain and contractors as a direct result of the above.
- 6.1.1 **It is agreed the following events are not to be construed as Force Majeure:**
- 1) a fire, accident or explosion caused by negligence or mismanagement of the builder
 - 2) any interruption to the supply of public utilities to the Builder caused by failure to pay utility bills or through negligence or mismanagement.
- 6.2 The Builder shall give the Purchaser written notice of any event in respect of which the Builder claims to be entitled to an extension of time:
- 6.2.1 within seven (7) days of its commencement, stating the date on which the delay commenced, the cause of it and its estimated duration; and
 - 6.2.2 within seven (7) days of its end, stating the date on which it ended and the total period of the extension to the Delivery Date.
- 6.3 If the Builder's premises, plant, machinery or equipment shall be so damaged by the operation of a delaying cause for which the Builder is not responsible so as to make it impracticable or impossible for the Builder to complete the construction of the Boat in a timely manner, the Builder may, at its option and in any event within twenty one (21) days of the operation of the delaying cause, cancel this Agreement by notice in writing to the Purchaser, whereupon the Purchaser shall be entitled by written election either:
- 6.3.1 to take over and complete the Boat without further liability on the Builder whereupon the Purchaser shall pay to the Builder all sums then due, whether by way of the Stage Payments or otherwise; or
 - 6.3.2 to require repayment of all Stage Payments paid by the Purchaser to the Builder up to that date, and upon such repayment, title in the Boat and all materials and equipment appropriated to the Boat shall re-vest in the Builder.

DM.  NR. 

7. Access to the Boat and to Builder's Premises

7.1 The Purchaser shall have the right to inspect the progress of construction of the Boat as the Purchaser sees fit which shall include any of the Builder's subcontracted scopes subject to the following conditions:

- 7.1.1 inspections shall take place during the Builder's normal business hours;
- 7.1.2 inspections shall be on reasonable notice –as to the timing, identity and authority of the persons attending – and subject to the consent of the Builder (such consent not to be unreasonably withheld);
- 7.1.3 the Builder shall be entitled to accompany the Purchaser or his representative(s) and require strict observance of the Builder's insurance requirements, Health and Safety policy and other regulatory requirements;
- 7.1.4 access shall extend only to those parts of the Builder's premises necessary for the inspection of the Boat and/or the materials and equipment intended for the Boat; and
- 7.1.5 the length, timing or frequency of such inspections shall not unreasonably interfere with the Builder's construction programme.

7.2 During such inspections and while at the Builder's premises or on the Boat, the Purchaser and his representative(s) shall observe all current rules and regulations applied by and to the Builder and its premises.



8. Warranties

8.1 In addition to the Purchaser's statutory rights, the warranties in Clause 8.2 shall apply.

8.2 Subject to the conditions which are set out at Clause 8.3, the Builder warrants to the Purchaser that the Boat will:

- 8.2.1 be of satisfactory quality and fit for the purpose made known to the Builder prior to the date of this Agreement whether or not such purpose is one for which the Boat is commonly supplied;
- 8.2.2 correspond with the Specification and any agreed variations, additions or modifications to the Specification;
- 8.2.3 be free from defects in materials and workmanship for a period of twelve (12) months from Delivery;
- 8.2.4 comply with all legislative requirements and regulations relating to the sale of the Boat in the UK and European Union for any purpose made known under Clause 8.2.1 above; and
- 8.2.5 comply with any other requirements or regulations which may be agreed between the Parties or its authorised representatives.

8.3 The Purchaser's statutory rights and the warranties set out in Clause 8.2 shall be subject to the following conditions:

DM.  NR. 
British Marine Federation BM6-2017 Standard Agreement for the Construction of a New Boat
5 of 17

DIVERSE · MARINE

COWES · ISLE OF WIGHT

- 8.3.1 the Builder shall have no liability for any defect or regulatory non-conformity in the Boat which arises directly as a result of the Builder's adherence to any part of the Specification which is specified, supplied or developed by the Purchaser or his agents;
- 8.3.2 the Builder shall be given the opportunity to repair or replace any defect or deficiency in workmanship, materials or equipment or any failure to conform with the Specification. Such repair or replacement shall be carried out by the Builder at its premises without cost to the Purchaser or, where that is not convenient to the Parties, for example where the vessel is working and the defects are small in nature, with no need to lift the vessel from the water, then the Builder shall travel to the vessel to rectify agreed defects. Where work is carried out away from the Builders premises the travel and accommodation expenses are to be for the Purchasers account. The Builder may decide to pay the reasonable cost of having such work carried out elsewhere by a third party such as one located at the Purchasers base port for the contract that it is on. In this case it is only done with the prior authorisation of the Builder and issuance of a purchase order from the Builder to the nominated contractor. No work will be paid for without a valid purchase order from the Builder;
- 8.3.3 the Purchaser shall notify the Builder in writing as soon as reasonably practicable on discovery of any alleged defect or deficiency and the Builder or its agent shall have the right to inspect the Boat including the right to carry out sea trials to enable the Builder or its agent to examine or assess the extent of the alleged defect or deficiency. The expense of any such trials shall be borne by the Builder if the defect is shown to be one of workmanship or materials.

9. Insurance

- 9.1 The Builder shall insure the Boat (together with all equipment and materials installed or intended for it and within the Builder's premises including the equipment 'free issued' by the Purchaser) from the date of this Agreement until the date of Delivery, noting, insofar as possible, the Purchaser's interest in the Boat. Please also see Clause 22.
- 9.2 Such insurance shall be affected with a reputable insurer for a sum equal to the replacement cost of the completed Boat (to a value of £3.25million inclusive of the free issued items) and shall include the cost of any additions or variations to the Specification which have been agreed between the Parties.
- 9.3 Such insurance shall be on terms no less favourable than the Institute Clauses for Builder's Risks published by the Institute of London Underwriters, as applicable from time to time. Documentary evidence of such insurance, its terms and conditions and proof of payment of the premium shall be provided to the Purchaser on request.
- 9.4 In the event that the Boat, equipment or materials sustain damage at any time before Delivery, any monies received in respect of the insurance shall be receivable by the Builder and shall be applied by it in making good such damage in a reasonable and workmanlike manner and the Delivery Date shall be extended by such period as shall be reasonably necessary to affect the necessary repairs. The Purchaser shall not be entitled to reject the Boat, equipment, or materials on account of such damage or repairs or to make any claim in respect of any resultant depreciation. If the Boat is declared an actual or constructive total loss the Purchaser shall have the option, to be exercised within twenty-eight (28) days of the loss, of cancelling this Agreement in which event the insurance money to the value of Stage Payments already paid shall be paid direct to the Purchaser by the insurers and the Purchaser will abandon all rights under the said insurance to the Builder. This Agreement will then terminate in all respects as if it had been duly completed and the Purchaser shall have no further right to claim against the Builder.

DM,  NR, 

10. Termination

- 10.1 Either Party shall be entitled to terminate this Agreement by written notice if;
- 10.1.1 the other Party becomes insolvent or initiates or becomes subject to any formal insolvency procedure or, in the case of an individual, is declared bankrupt or makes any arrangement with or for the benefit of their creditors.
 - 10.1.2 the other Party has breached a fundamental term of this Agreement and has been given written notice of the need to correct the breach but has failed to do so within twenty eight (28) days of that written notice and has not referred the matter to dispute resolution under the provisions of Clauses 18 and 0.
- 10.2 If the Builder exercises its right to terminate this Agreement under this Clause 10, title to the Boat shall pass to the Builder and the Builder shall be entitled to sell the Boat, the materials and the equipment and/or any other property of the Purchaser in the possession of the Builder for the purpose of the construction of the Boat. The Builder shall give the Purchaser twenty-eight (28) days' written notice of its intention to sell the Boat and/or other property and such notice shall give details of the reasons for the sale including details of any sums due and payable to the Builder together with details of the proposed method of sale. Following the sale of the Boat and/or other property the Builder shall repay to the Purchaser the balance of the proceeds of sale after deduction of all sums owing to the Builder and all reasonable legal or other expenses including, but not limited to, the costs of sale and maintenance and storage charges incurred by the Builder.
- 10.3 Where this Agreement is governed by English law, in addition to any other rights contained in this Agreement, the provisions of the Torts (Interference with Goods) Act 1977 (the "Act") shall apply in relation to an uncollected Boat and/or other property. This Act confers a Right of Sale on the Builder in circumstances where the Purchaser fails to collect or accept delivery of goods (which includes the Boat and any other property). Such sale will not take place until the Builder has given notice to the Purchaser in accordance with the Act. For the purpose of the Act it is recorded that:
- 10.3.1 the Builder's obligation to the Purchaser as custodian of the Boat and other property ends on the expiry or termination of this Agreement.
 - 10.3.2 the place for Delivery and collection of the Boat shall be at the Builder's premises.
- 10.4 The Purchaser shall co-operate with the Builder insofar as may be necessary to affect a sale of the Boat including signing or confirming any authority or instructions.
- 10.5 Termination under this Clause 10 shall not affect any other rights or remedies which the Parties may have.
- 10.6 All 'free issued' items by the Purchaser will remain the property of the Purchaser, be marked with the Purchaser's name and be returned in the event of Builders insolvency. See also Clause 22.

DIVERSE · MARINE

COWES - ISLE OF WIGHT

10.7 The Purchaser shall have the right to terminate this Contract forthwith upon giving notice in the event that the Builder fails to perform any work relating to the construction of the Vessel for a running period of at least 30 days. If this Contract is terminated by the Purchaser, the Builder shall release the Purchaser from the obligations of this Contract upon payment of the next non-issued Stage Payment Installation (invoice to be raised by the Builder without delay) as provided in Annex 2. On the Builders receipt of payment, the Builder shall release the Purchaser from the claim provided in Clause 11.1 and all materials, gear or equipment bought or appropriated to the Agreement can be collected within 5 working days. Storage costs will be charged beyond this date and be paid prior to collection.

11. Ownership of the Boat

11.1 The Boat and/or all materials and equipment purchased or appropriated from time to time by the Builder specifically for its construction (whether in its premises, upon the water or elsewhere) shall become the property of the Purchaser upon payment to the Builder of the 1st Stage Payment. As and from that date, title in additional materials, gear and equipment bought for or appropriated to the Agreement shall pass to the Purchaser upon such purchase or appropriation. The Builder shall, however, have a claim (known as a "lien") over and be entitled to retain possession of the Boat and any materials or equipment purchased for or appropriated to the construction until it has received full payment of all sums due to it under this Agreement and any variations, whether invoiced or not excluding those free issued items supplied by the Purchaser. Title in any materials or equipment rejected by the Purchaser or otherwise not used in construction of the Boat shall immediately pass back to the Builder.

11.2 The Builder shall, so far as it is reasonably practicable to do so, mark all individual items of equipment and materials which are purchased for or appropriated to the construction of the Boat.

11.3 The Purchaser shall not without the prior written consent of the Builder (which shall not be unreasonably withheld) sell, assign, pledge or otherwise charge this Agreement or any rights arising under it, or the Boat itself by way of security for any indebtedness prior to Delivery except for the sole purpose of obtaining a loan to finance the construction of the Boat. If the Purchaser charges the Boat in breach of the terms of this Clause 11.3, the full balance of the Contract Price shall become immediately due and payable without affecting any other rights or remedies of the Builder.

12. Consumer Rights


12.1 If:

12.1.1 the Builder is acting in the course of his/her trade;

12.1.2 the Purchaser is a consumer for the purposes of the Consumer Contract (Information, Cancellation and Additional Charges) Regulations 2013; and

12.1.3 this Agreement is a distance or off-premises contract for the purposes of the Consumer Contract (Information, Cancellation and Additional Charges) Regulations 2013,

the Purchaser may be entitled to cancel this Agreement within fourteen (14) days from the day on which the Purchaser acquires physical possession of the Boat (the "Cancellation Period"). If this right to cancel this Agreement is exercised by the Purchaser, the Purchaser shall bear the cost (if any) of transporting and redelivering it to the Builder, as well as any other relevant charges as may be notified to the Purchaser by the Builder. If, as a result of the Purchaser's handling of the Boat, beyond what is necessary to establish the nature, characteristics and functioning of the Boat, the Boat's value is diminished by any amount, the Builder may recover that amount (up to the Purchase Price) from the Purchaser.

DM. NR. ^{DS}

DIVERSE · MARINE

COWES · ISLE OF WIGHT

13. Third Party Rights

- 13.1 A person who is not a party to this Agreement shall have no right under the Contracts (Rights of Third Parties) Act 1999 to enforce any term of this Agreement.

14. Copyright

- 14.1 Any copyright or similar protection in manuals, drawings, or plans, specifications, including the Specification, prepared by the Builder or its employees or agents, shall at all times remain the property of the Builder. Any copyright or similar protection in manuals, drawings or plans including the specification provided by the Purchaser or its chosen vessel designer remain the property of the Purchaser.

15. Notices

- 15.1 Any notice to be served under this Agreement on either Party shall be in writing and shall be sufficiently served if delivered personally or posted by recorded delivery to the address set out in this Agreement (unless the Party has by written notice to the other Party substituted a different address in England as the notice address). Any posted notice shall be deemed to have been received on the third business day after the time of posting.
- 15.2 Notices may also be served by e-mail or fax, in which case they shall be deemed received upon despatch if despatch was on a business day in the United Kingdom and within 0900-1700 hours UTC and there was no delivery failure notice. If despatched before 0900 hours UTC on a business day, the notice shall be deemed received at 0900 hours UTC that day. If despatched after 1700 hours UTC on a business day or on any non-business day, the notice shall be deemed received at 0900 hours UTC on the next business day.

Address for notices:

Diverse Marine Ltd
Medina Yard, Pelham Road, Cowes, Isle of Wight, PO31 7PG, United Kingdom
FAO Mr Ben Colman
e-mail: bencolman@diversemarine.co.uk
Tel : +44 1983 300656

Nauticus Robotics
17146 Feathercraft Lane, Webster, TX77598, United States of America
FAO Mr Todd Newell
e-mail: tnewell@nauticusrobotics.com
Tel : +1 832 577 8234

16. Entire Agreement

- 16.1 This Agreement constitutes the entire agreement between the Parties and supersedes any previous arrangement, understanding or agreement between them relating to the subject matter of the Agreement.
- 16.2 Each Party acknowledges that, in entering into the Agreement it does not rely on any statement, representation, assurance or warranty of any person (whether a party to the Agreement or not) other than as expressly set out in the Agreement.
- 16.3 Nothing in this Clause 16 shall limit or exclude any liability for fraud.
- 16.4 Any variations or alterations to this Agreement must be in writing and signed by the Parties.

DM.  NR. 
British Marine Federation BM6-2017 Standard Agreement for the Construction of a New Boat
9 of 17

DIVERSE · MARINE

COWES · ISLE OF WIGHT

- 16.5 This Agreement may be executed by the Parties in any number of counterparts, each of which shall be deemed to be an original but all of which taken together shall constitute one and the same instrument and shall become effective when one or more counterparts have been signed by each of the Parties and delivered to the other party.
- 17. Interpretation**
- 17.1 The construction and meaning of this Agreement is not to be affected by any headings.
- 17.2 To the extent that the terms of this Agreement contradict any laws on consumer rights, the rights conferred on any Party who is a consumer shall remain unaffected.
- 17.3 If any provision of this Agreement is deemed for any reason to be invalid, void or deleted, the Agreement shall nonetheless remain in full force and effect as if such provision had not originally been included. In such circumstances, the Parties shall negotiate in good faith in order to agree the terms of a mutually acceptable and satisfactory alternative provision in place of the invalid, void or deleted provision. If such agreement cannot be reached, the Agreement shall remain in full force and effect without such provision.
- 18. Law & Jurisdiction**
- 18.1 If the Purchaser is not a consumer for the purposes of the Consumer Contract (Information, Cancellation and Additional Charges) Regulations 2013:-
- 18.1.1 This Agreement and any non-contractual obligations arising out of, or in connection with, this Agreement shall be governed by and construed in accordance with:
- 18.1.1.1 English law, if the principal place of business of the Builder is in England; or
- 18.1.1.2 Scots law, if the principal place of business of the Builder is in Scotland.
- 18.2 If the Purchaser is a consumer for the purposes of the Consumer Contract (Information, Cancellation and Additional Charges) Regulations 2013:-
- 18.2.1 This Agreement and any non-contractual obligations arising out of, or in connection with, this Agreement shall be governed by and construed in accordance with:
- 18.2.1.1 English law, if the principal place of residence of the Purchaser is in England; or
- 18.2.1.2 Scots law, if the principal place of residence of the Purchaser is in Scotland.
- 18.3 Subject to Clause 19. below, the Parties irrevocably agree that any and every dispute (and any non-contractual obligations, as aforesaid) arising out of or in connection with this Agreement shall be subject to the non-exclusive jurisdiction of the English courts.
- 18.4 A dispute on a technical issue may, with the agreement of both Parties, be referred to a single surveyor who shall be independent of the Parties and whose identity and terms of reference shall be agreed by the Parties or, in default of agreement by the Parties within seven (7) days from receipt of the written notice from one of the Parties for such a referral, a surveyor shall be appointed from an independent Naval Architect, Walker Marine Design Ltd.
- 18.5 A surveyor appointed or nominated under Clause 18.4 shall act as an expert and not as an arbitrator and his written decision shall be final and binding upon the Parties and his fees and expenses shall be borne equally by the Parties.

DM.  NR. 
British Marine Federation BM6-2017 Standard Agreement for the Construction of a New Boat
10 of 17

DIVERSE · MARINE

COWES · ISLE OF WIGHT

- 18.6 For the purposes of Clause 18.4, technical issues include, by way of example, whether a Stage Payment is due, the operation or duration of a delaying event, whether for the purposes of the insurance the Boat has suffered damage, and the Boat's conformity with the Specification.
- 19. Arbitration**
- 19.1 Any dispute arising out of or in connection with this Contract shall be referred to arbitration in London in accordance with the Arbitration Act 1996 or any statutory modification or re-enactment thereof save to the extent necessary to give effect to the provisions of this Clause.
- 19.2 The arbitration shall be conducted in accordance with the London Maritime Arbitrators Association (LMAA) Terms current at the time when the arbitration proceedings are commenced.
- 19.3 The reference shall be to three arbitrators. A Party wishing to refer a dispute to arbitration shall appoint its arbitrator and send notice of such appointment in writing to the other Party requiring the other Party to appoint its own arbitrator within fourteen (14) calendar days of that notice and stating that it will appoint its arbitrator as sole arbitrator unless the other Party appoints its own arbitrator and gives notice that it has done so within the fourteen (14) days specified. If the other Party does not appoint its own arbitrator and give notice that it has done so within the fourteen (14) days specified, the Party referring a dispute to arbitration may, without the requirement of any further prior notice to the other Party, appoint its arbitrator as sole arbitrator and shall advise the other Party accordingly. The award of a sole arbitrator shall be binding on both Parties as if he had been appointed by agreement.
- 19.4 Nothing herein shall prevent the Parties agreeing in writing to vary these provisions to provide for the appointment of a sole arbitrator.
- 19.5 In cases where neither the claim nor any counterclaim exceeds the sum of £75,000 (or such other sum as the Parties may agree) the arbitration shall be conducted in accordance with the LMAA Small Claims Procedure current at the time when the arbitration proceedings are commenced.
- 20. Subcontracting**
- 20.1 The Builder may employ the Sub-contractor Aluminium Marine Consultants for fabrication and Boat Electrics & Electronics or electrical/electronic works. Otherwise except for minor work, the Builder shall not employ other sub-contractors without the Purchaser's approval, which shall not be unreasonably withheld. Notwithstanding any sub-contracting, the Builder shall remain fully responsible for the due performance of all such work as if undertaken by the Builder.
- 21. Reporting**
- 21.1 As soon as possible and not later than ten (10) days after the effective date of the Contract the Builder shall provide the Purchaser with a detailed build timeline. The timeline will be continually updated as the build progresses and issued to the Purchaser on fortnightly basis highlighting any areas of delay or concern.

DIVERSE · MARINE

COWES · ISLE OF WIGHT

22. Free Issue items

- 22.1 The Builder shall safely store and handle the Purchasers free-issue items after delivery thereof at a warehouse or other storage facility at the Shipyard and shall, at its own cost, expense and responsibility, install them in or on the Vessel in accordance with the Specification, provided that the Builder shall not be responsible for the quality, efficiency and/or performance of any of the items.
- 22.2 The items shall at all times remain the property of the Purchaser but shall be at the Builder's risk from the time of their delivery to the Shipyard until the time of their redelivery to the Purchaser whether or not as part of the Vessel.

DM.  NR. 
British Marine Federation BM6-2017 Standard Agreement for the Construction of a New Boat
12 of 17

DIVERSE · MARINE

COWES · ISLE OF WIGHT



DM.  NR ^{DS}

British Marine Federation BM6-2017 Standard Agreement for the Construction of a New Boat

DIVERSE · MARINE

COWES · ISLE OF WIGHT

ANNEX 1

SPECIFICATION

The Specification for the Boat is as set out below or as identified below and attached to this Agreement and signed by the Parties.

Contract Specification Reference & Attached
DM-2342 Vessel Specification Issue A 19-01-22

Contract General Arrangement & Attached:
21021-010101_F 11-11-21

ANNEX 2

AGREEMENT VALUE & STAGE PAYMENT SCHEDULE

Contract Value: [REDACTED] (Great British Pounds)

Nauticus Robotics Free Issue Equipment:

- o Kongsberg Launch & Recovery System (LARS) Complete:
 - o Structure
 - o Rails & Track
 - o Winch & Powerpack
 - o Commissioning & Testing
 - o Diverse Marine have allowed to bolt down equipment only
- o Nauticus Robotics Aquanaut
 - o Complete with all Associated Equipment & Charging
- o Aquanaut Control, Monitoring & Autonomy Equipment
- o WIFI Mesh System
- o Cyber Security Hardware & Software Costs
- o Operational Equipment & Anything Not Specifically Mentioned in the Specification

Stage Payment Schedule:

Boat Name		Value	Delivery
Hyeronaut 3 (HY3)		[REDACTED]	24/03/2023

Stage Descriptions	%	Value	Indicative Payment	Supporting Information for Payment
Deposit	10%	[REDACTED]	Feb-22	Signed Contract
Completion of Marine R&D Design & Drawing Package	5%	[REDACTED]	Mar-22	Shipyards Declaration Supported by GND Information
Manufacture R&D Approval	5%	[REDACTED]	Jul-22	Shipyards Declaration, Photographs & Quality Certificates
Frames Complete & Keels Standing	15%	[REDACTED]	Aug-22	Shipyards Declaration & Photographs
Hull Structure Complete	25%	[REDACTED]	Dec-22	Shipyards Declaration, Photographs & TRF Quality Form
IPS System Ready to Dispatch	15%	[REDACTED]	Dec-22	Shipyards Declaration & Supporting Golden Arrow Documentation
Installation of IPS System	15%	[REDACTED]	Feb-23	Shipyards Declaration, Photographs & TRF Quality Form
Acceptance	10%	[REDACTED]	Mar-23	Signed Acceptance Certificate

DM  NR  DS
 British Marine Federation BM6-2017 Standard Agreement for the Construction of a New Boat
 15 of 17

ANNEX 3

DELIVERY DATE & LATE DELIVERY PENALTIES

Delivery Date: 24th March 2023

A3.1 If delivery takes place more than 30 days after the delivery date then for each day thereafter the Contract Price shall be reduced by the amount GBP600 per day as liquidated damages up to a maximum delay of 90 days (comprising a 30-day grace period plus 60 days). If the delay exceeds 90 days, the Purchaser shall have the option to terminate this Agreement in accordance with Clause 10.1.

DIVERSE · MARINE

COWES · ISLE OF WIGHT

ANNEX 4

CERTIFICATE OF DELIVERY & ACCEPTANCE

TO BE INSERTED

CERTAIN IDENTIFIED INFORMATION HAS BEEN EXCLUDED FROM THIS EXHIBIT BECAUSE IT IS BOTH NOT MATERIAL AND IS THE TYPE THAT THE REGISTRANT TREATS AS PRIVATE OR CONFIDENTIAL.



Nauticus Robotics Inc.

**Commercial Proposal for DriX Uncrewed Surface Vehicle
(USV) & ancillaries**



iXblue document ref. QU_2111_41317 dated December 6, 2021

iXblue property

iXblue Inc.
1580 Lincoln St. Suite 860, Denver CO 80203
www.ixblue.com

1 Reference of the inquiry

Nauticus Robotics Point of Contact

Mr. Todd NEWELL
SVP Business Development
17146 Feathercraft Lane, Suite 450 Webster, TX 77598
Cell: (823) 577-8234
tnewell@nauticusrobotics.com

iXblue Point of Contact

Mr. Euan MACKAY
Business Development Manager North America
1580 Lincoln St, Suite 860, Denver CO 80203
Cell: (832) 474- 1182
euan.mackay@ixblue.com

Mr. Stephane VANUFFELEN

Marine Autonomy Technical Director
46 Quai François Mitterrand, NEF A 13600 La Ciotat France
Cell: +33 6 12 60 24 23
stephane.vannuffelen@ixblue.com

Offer Details

Nauticus Robotics Hydronaut vessel delivery schedule is currently 12-14 months and out with the scope of delivery requirements for their end client. The Aquanaut Robotic system is available in 8 to 9 months and hence consideration to purchase the DriX System to provide the complete solution.

Nauticus Robotics Inc. are requesting the DriX Solution to host the Acomm modem system to be delivered in June of 2022.

Therefore iXblue Inc., will provide both the Commercial & Technical proposal on DriX system and all associated communication ancillaries.

Delivery preference with the DriX is to TAU Testing center, near Stavanger / Norway for August 2022 so that full SAT's on the DriX and the Aquanaut system can be commissioned in August/ September 2022 timeframe. The complete Turnkey solution is expected to be in the field by February/March 2023 operating in UK & European waters. This schedule is subject to change.

Applicable documents

- ✓ Technical description of DriX USV is detailed in document ref: "*DRIX Technical description_12_Nauticus_Robotics*"
- ✓ Technical description of iXblue GAPS USBL M7 ref: "*TD-GAPSM7-AN-001-C*"
- ✓ Technical description of iXblue Oceano MT912S-R ref: "*iXblue-DS-Oceano MT912S Series - 2019-04(1)*"
- ✓ IXBLUE GENERAL TERMS AND CONDITIONS OF SALE FOR DRIX USV Rev. 26/04/21
- ✓ DriX Concept of Operations 'CONOPS', User manual, FAT/SAT/HAT as well as Survey Mission Reports are available upon request.

2 Commercial offer

Summary

Detailed pricing for Nauticus Robotics Inc., for iXblue DriX Uncrewed Surface Vehicle (USV) in accordance with the data specifications & concept of operations set by Nauticus Robotics Inc.

Item	Product	Unit price	Qty	Total Price
1.	DriX USV			
	✓ Including Custom Gondola			
	<i>Design, production, cable (except modem cables) and weight balance of Gondola DOLPHIN + SUBNERO + GAPS M7 (USBL). Sensors & cables can be customer supplied or priced separately as listed in Section 2</i>			
	✓ Including Payload Integration, offset, setup and testing			
	<i>Processor unit installation in DriX. Offset measurements, cable connection, configuration setup and trials using associated software</i>			
	✓ Including LARS DDS			
	<i>Launch and recovery system includes the launcher, the docking auto function (including 1 iXblue Quadrans AHRS inside the DDS) Excluding 2 lift points for Davit application, this is an optional extra if required and priced upon request</i>			
	✓ Including Shipping container			
	<i>Forty feet long, hardtop container. Includes one cart to get DriX out of the container.</i>			
	✓ Including Spare parts package			
<i>Basic spare list – available upon request</i>				
✓ Including Maintenance Kit				
<i>For up to 3000 hours of operation</i>				
✓ Including Delivery FCA La Ciotat France				
<i>As per Incoterm ICC 2010</i>				
2.	DriX USV add-on: Payload & Sensors			
	✓ Including Valeport Sound velocity sonder mini SVS			
	<i>Fitted in in Gondola</i>			
	✓ Including iXblue GAPS USBL M7			
	<i>As per datasheet & technical description Ref: TD-GAPSM7-AN-001-C</i>			
✓ Including iXblue OCEANO MT912S-R				
<i>Required for Acoustic positioning of Aquanaut Robot As per datasheet & technical description Refⁿ iXblue-DS-Oceano MT912S Series - 2019-04(1)</i>				
3.	DriX USV add-on: Communication & Navigation			
	✓ Including Over the horizon capability			
	<i>Over the Horizon SATCOM Thales Vessel Link 350 - recommended considering 4G coverage uncertainty. It does not include any service subscription.</i>			
	✓ Including Radar Halo 20+			
✓ Including MBR 144 antenna for DriX USV				

Item	Product	Unit price	Qty	Total Price
4.	DriX Training & Support			
	✓ Including DriX Supervisor Training <i>Including E-learning and onsite 6 days training in La Ciotat, France. Transportation and accommodation for trainees are not included in this price which is for up to 4 persons in La Ciotat, France. From that basis, an extra 7,230 USD is required for any additional persons</i>			
	✓ Including Maiden Mission support <i>One iXblue engineer assistance for first mission(s) - max 30 business days of customer assistance, excluding "Travels and Expenses"</i>			
	✓ Including DriX Software's & updates <i>DriX routine updates for 2 years after delivery). Software Extended Maintenance SEMA (Annual extension fee of \$ 6000.00), including DriX software routine updates & Simulator updates.</i>			
5	✓ Not Included - Additional Support from DriX Operational Service Team <i>Day rate is \$1,500.00 per person per day, excluding "Travels and Expenses"</i>			
	DriX USV add-on: Payload & Sensor Options			
	✓ Not Included - Winch for CTD/ SVP sounder			
	✓ Not Included - Valeport SVP SWIFT sound velocity profiler <i>Fitted on winch</i>			
TOTAL				

Conditions on pricing for DriX (USV)

- **Terms and conditions:** The iXblue general terms and conditions of sale, as listed in 'Applicable Documents in section 1' ref. 'IXBLUE GENERAL TERMS AND CONDITIONS OF SALE FOR DRIX USV Rev. 26/04/21' are fully applicable to the present quote and to the related order/s. They are completed by the following terms and conditions which will prevail, as the case may be.
- **Delivery schedule:** Delivery time for the DriX USV configured to accommodate required sensors is T0 + 7 months from the time the Purchase Order is received at iXblue. **Purchase Order must be received no later than the 17th of December 2021.** Delivery for the DriX USV is per Incoterm EXW La Ciotat France, as per Incoterm ICC 2010. Transit time for DriX shipment direct from the Shipyard in La Ciotat to TAU in Stavanger Norway will be determined after order is received. Whenever external sensors are required, the delivery terms stipulated above are conditional to the receipt of these goods in due time at iXblue shipyard for their integration in DriX USV as per the production planning. iXblue are not responsible for delays with the DriX System/s if any components due by the client is not received within the requested timeframe. The timeframe for these components will be determined on the Order Acknowledgement. Whenever an export, import or transfer license or authorization is required, iXblue shall not deliver the concerned goods or services before receiving the said license or authorization. Therefore, the delivery terms stipulated in this quote are conditional to the receipt of any export, import or transfer license or authorization required.

- **Prices:** Net in US Dollars, exclusive of VAT, freight, insurance, import taxes, custom fee or other duties. The Incoterm applicable is FCA – France, according to INCOTERMS ICC 2010.
- **Payments:** Payments can be remitted via check or wire transfer.
- **Invoicing for Item 1, 2, 3 & 5:** Payment terms for all invoices are 30 days net upon presentation of Commercial Invoice. iXblue will invoice for all payments based on the following milestone billing schedule:
 - *30% down payment at the time of PO issuance*
 - *60% due at the time of Factory Acceptance Testing of DriX USV in La Ciotat, France*
 - *10 % due at Sea Acceptance Tests, full report to be signed and witnessed by both iXblue and customer situated in TAU Testing Centre, Norway*
- **Invoicing for Item 4:** 100% upon delivery of goods or completion of services, NET30 upon presentation of Commercial Invoice.
- **Warranty:** Each DriX package comes with a 12-month warranty upon delivery.
- **Offer validity:** This offer is valid until 12/17/2021, with delivery within 24 months.
- **COVID-19 Disclaimer:** The implications of the Coronavirus pandemic are currently difficult to foresee. iXblue will make all reasonable commercial efforts to overcome the Coronavirus pandemic implications in the best interest of the customer, but formally reserve the right, subject to reasonable prior written notice and consultation with the customer, to delay, extend, or suspend the deliveries or services to the extent necessary due to any relevant impeding implications on deliveries or services caused by or related to the Coronavirus pandemic. iXblue will cover its own costs in relation to such necessary delay, extension, or suspension, but shall not be liable for or responsible for, and the customer shall hold iXblue harmless from and against, any costs or consequences incurred by or on part of the customer.

IXBLUE GENERAL TERMS AND CONDITIONS OF SALE FOR DRiX USV

Rev. 26/04/21

ARTICLE 1 – APPROVAL OF THE GENERAL TERMS AND CONDITIONS OF SALE

1.1. The present General Terms and Conditions of Sale (hereinafter referred to as the "GTCS"), together with the particular conditions which complete or modify the GTCS, set out the conditions under which iXblue sells the DriX USV and its related accessories and services (hereinafter the "USV") to the customer (hereinafter referred to as the "Customer") and are part of the order (hereinafter referred to as the "Order") between iXblue and Customer. iXblue's offer is also ruled by present terms and conditions and is part of the Order.

1.2. If accepted in writing by iXblue, any particular conditions shall be prevail on the GTCS.

1.3. Save with iXblue's written consent, any terms and conditions included in the general conditions of purchase or any other documents coming from the Customer are not applicable to the Order.

1.4. By accepting any offer from iXblue, the Customer shall be deemed to have approved the Order's terms and conditions unconditionally, and hereby undertakes not to invoke any document against any of the provisions herein.

ARTICLE 2 – CONTRACT OF SALE

2.1. Only Orders confirmed in writing by iXblue will be deemed definitely agreed and binding. The confirmation will be formalized by issuance of an Order acknowledgment, subject to any constraint due to export control rules.

2.2. In case of contradiction between quotation, Order and Order acknowledgment from iXblue, the later shall prevail.

2.3. In case a Customer wishes to cancel any Order after the unconditional acceptance of iXblue, the Customer shall be liable to pay to iXblue, by rights, an order cancellation compensation of 30% of the Order value. Moreover, for any Order or item of an Order corresponding to non-recurrent engineering activities and/or to goods with lead times of ten (10) weeks or more, the said compensation will be increased by:

- 20%, to a total of 50% of the Order value, if the cancellation is received at iXblue's premises more than eight (8) weeks before the last planned delivery date,
- 40%, to a total of 70% of the Order value, if the cancellation is received at iXblue's premises between eight (8) and four (4) weeks before the last planned delivery date,
- 70%, to a total of 100% of the Order value, if the cancellation is received at iXblue's premises within four (4) weeks of the last planned delivery date.

2.5. iXblue shall have the right to charge the compensation, in whole or in part, against any advance payment received. The balance of the compensation shall be paid by the Customer upon its Order cancellation. Any delay in payment shall trigger application of the interest payments as per article 7.3 below, starting on the cancellation receipt date. Upon payment of the compensation, the Customer is deemed to have waived any right on the ordered goods.

ARTICLE 3 – DELIVERY OF THE USV**3.1. Conditions**

The USV shall be delivered to the Customer in accordance with the Incoterm (ICC 2020) stipulated in the offer issued by iXblue. Transfer of risks occurs according to the conditions of said Incoterm. If no incoterm is specified, Incoterm FCA La Ciotat harbor (France) shall be applicable by default.

3.2. Delivery time

The planned lead times stated in iXblue's Order acknowledgment have indicative value. Delays with respect to the planned lead times shall not give rise to any damages, indemnification, liquidated damages, compensation, price reduction or cancellation of Order. Whenever possible, iXblue will inform the Customer as soon as it will appear that the last communicated planned delivery date will not be fulfilled and will provide a new planned delivery date simultaneously.

3.3. Transfer of title and of risks

The transfer of property and of the risks of the USV (including all risks associated with USV operations at sea) from iXblue to the Customer shall occur upon the delivery date of the USV. Upon transfer of property and risks of the USV to the Customer, the Customer shall assume solely and exclusively all responsibilities related to the operation and use of its USV anywhere in the world and shall save, defend and indemnify iXblue against all and any claim, action, recourse, liability or demand of any kind, resulting from the use, rental and/or operation of the USV by the Customer or from any damage to third party by the Customer.

3.4. Partial deliveries

iXblue may make partial or total deliveries after prior notification to the Customer.

ARTICLE 4 – EXPORT/IMPORT CONTROL

4.1. Whenever an export, import or transfer license is required for the Order approval and performance, iXblue is committed and bound to the said Order only once all the licenses required have been received. To that extent, iXblue reserves the right to issue a first Order acknowledgment conditional to the reception of the said licenses. In this case, a second non-conditional Order acknowledgment may be issued once the said licenses would have been received, confirming the planned delivery date.

4.2. Pursuant to the applicable export control rules, the Customer undertakes to comply with any obligation stated by the French authorities and with any declaration on his behalf, particularly as related to the final utilization of the sold USV or to the commitment to non-re-exportation without prior authorization.

4.3. iXblue shall not be liable to the Customer for any denial or withdrawal of any export license by the competent authorities. Such a situation shall be considered as a force majeure event under this Order and article 13 shall apply.

ARTICLE 5 – AUTHORIZATION TO RE-SELL THE USV SOLD

The Customer is deemed to use the USV sold in the Customer's normal course of business. Up until full discharge of the sold USV from the property reserve in accordance with article 8 below, the Customer shall not re-sell the USV delivered, nor pledge the USV delivered or use them as security, or transfer the title thereto, even as a guarantee. Notwithstanding the above-mentioned points, the Customer shall not re-sell the sold USV in breach of the provisions of article 4 above.

ARTICLE 6 – SERVICES RELATED TO THE USV

6.1. The performance of any service related to the USV will be accomplished at the premises of iXblue or in any other place mutually agreed with the Customer. Except as otherwise stated, the said services shall be performed in accordance with the applicable procedures in force in iXblue and iXblue shall provide the Customer with all the possible prerequisites and prior dispositions that fall under Customer's responsibility. The concerned personnel from

iXblue and the Customer, including any contractors, sub-contractors and consultants, shall be informed of the regulations in force in any location where the services are to be performed and shall comply with said dispositions, iXblue and the Customer remaining responsible for their own personnel.

6.2. Except in case of expressly stipulated and justified reserve by the Customer following the completion of any service and confirmed in writing to iXblue within three (3) calendar days, the said service performance shall be deemed accepted without reserve by the Customer.

ARTICLE 7 – PRICE AND PAYMENT TERMS

7.1. Pricing

The price of the USV and any related services is in Euro and is defined within iXblue's offer issued to the Customer and in the Order acknowledgment. Each party the taxes, charges or duties said party is liable for under the applicable law. Any banking costs shall be borne by the Customer.

7.2. Terms of payment

Unless otherwise stated, the price shall be paid by the Customer according to the payment terms stipulated in the offer issued by iXblue. Unless otherwise stated in iXblue offer, payment shall be made by bank transfer at maturity as stated on the invoice(s) – or thirty (30) calendar days net from invoice date if no maturity mentioned on invoice(s) – and using the bank details provided by iXblue. A payment is deemed as done when the corresponding sum is received on iXblue bank account.

7.3. Delays of payment

In case of delay of payment, iXblue shall be entitled to apply a penalty on the amount of the relevant invoice, calculated on the basis of an interest rate equal to the refinancing rate of the European Central Bank increased by ten (10) percentage points. In addition to this penalty, iXblue shall be entitled to the payment of a lump sum as defined in the article L441-6 of the French Commercial Code. When the payment recovery costs supported effectively are greater than the lump sum compensation, iXblue may also claim, upon justification, an indemnity for the extra costs incurred. In addition, iXblue has the right to suspend execution of the Order upon notice to the Customer. In case of continued non-payment, iXblue is entitled to terminate the Order for default of the Client, without prejudice to any right iXblue to claim for any damages or start any action for the return of the USV.

ARTICLE 8 – RETENTION OF TITLE

iXblue shall keep full title to the USV sold until the price has been fully paid, including the principal, and any applicable interests, penalties and indemnities. Any failure to pay any amounts payable on due date shall entitle iXblue to claim for the USV. In case of a seizure, or in case of a third-party procedure, before full payment of the due amounts, the Customer shall notify iXblue immediately and shall inform the said third party of the retention of title by iXblue. The above provisions shall not make obstacle to the transfer to the Customer, upon delivery, of all the risks (loss and damage) associated to the USV sold.

ARTICLE 9 – ACCEPTANCE OF THE USV

9.1. Any test and trials of the USV shall be carried out in La Ciotat (France). iXblue shall provide the crew for the performance of these tests and trials. If some Customer's equipment is installed on board USV or used during USV trials, all risks of loss or damage to these Customer's equipment shall be borne by the Customer who waive any right of claim (including from its insurers) against iXblue as

a result of these later loss and damage to Customer's equipment

9.2. Except in case of expressly stipulated and justified reserve issued by the Customer within five (5) calendar days following date of completion of the tests and trials of the USV, the Customer is considered as having accepted the USV with no reserve and iXblue shall be entitled to carry on the performance of the Contract and to ask to the Customer to perform its own obligations. In case of reserve, the Customer shall provide iXblue with all evidence in proof of the defects detected. iXblue shall provide of certificate of acceptance of the USV.

9.2. All transportation costs and risks associated with the return of the USV shall be borne by the Customer.

9.3. In case of any apparent defect or non-conformity observed on the USV, and provided that it has been duly ascertained by iXblue in writing, this defect shall be remedied by iXblue at its own costs as soon as possible. The Customer is prohibited from intervening on its own or having any third party intervene and shall facilitate any action from iXblue intended to remedy to the defect.

ARTICLE 10 – WARRANTY

10.1. iXblue warrants that the USV shall be delivered free from defective material, workmanship, design or assembly during normal use. This warranty is valid for twelve (12) months from the date of delivery as per article 3 above.

10.2. As soon as the Customer is aware of any defect covered by the warranty, the Customer shall notify in writing such defect to iXblue. As part of the warranty, iXblue shall decide at its sole discretion the nature of actions to take to repair the USV. This warranty covers, at iXblue's costs, the repair or re-performance of parts of defect on the USV. Any part of the USV repaired by iXblue or its authorized representatives duly chosen and instructed in writing by iXblue, within the warranty provided under this article 10 shall benefit from a new warranty period of six (6) months, starting from the delivery of the repaired USV to the Customer.

10.3. This warranty is definitely void and not applicable if:

- If the nonconformity, defectiveness or malfunction affecting the USV was caused by an improper use or changes made by the Customer, without iXblue's consent, or
- If the defect develops as a result of mishandling or non-adherence to the planned maintenance schedule, or
- Any use of the USV contrary to instruction manual or any other instruction that may have been given by iXblue, or
- In case for normal deterioration (wear and tear) of the USV.

10.4. Transportation costs and risks

Any return of USV to iXblue under warranty shall be previously agreed upon in writing by iXblue, all costs and risks to return the USV to the location stipulated by iXblue being borne by the Customer. All costs and risks for the return of the USV to the Customer, to the location stipulated by the Customer within France mainland, shall be borne by iXblue.

10.5. Intervention on site

The interventions by iXblue personnel in the Customer's premises shall be performed in accordance with the applicable procedures in force within iXblue and iXblue shall provide the Customer with all prerequisites and prior dispositions that fall under the later's responsibility. The concerned personnel from iXblue and the Customer, including any contractors, sub-contractors and consultants, shall be informed of any regulation in force in any location where the services are to be performed, iXblue and the

Customer remaining responsible for their own personnel. In case the terms of the contractual warranty as exposed in article 10 above or the stated prerequisites and prior dispositions happen not to be satisfied, iXblue reserves the right to invoice the Customer for the intervention realized (personnel and travel costs), with prices available upon demand.

ARTICLE 11 – DRIX USV OBLIGATIONS AND TRAINING

11.1. The Customer acknowledges that the USV purchased from iXblue is a standard product designed to be compliant with the standard laws and regulations applicable in France and with iXblue's own operational requirements.

11.2. The Customer is deemed to be the only party to have full knowledge about all legal, regulatory and operational requirements applicable in the place where the USV, after delivery by iXblue, shall be used and/or registered by the Customer. As a consequence of the foregoing, it shall be the exclusive Customer's responsibility, before signature of the Order, to ensure compliance of the USV with all legal, regulatory or operational requirements applicable in the areas where the Customer wishes to use the USV after delivery and which could have impact on the construction and/or the operational deployment and use of the USV by the Customer.

11.3. Failing to notify to iXblue, prior to conclusion of the Order, any specific legal, regulatory and operational requirement, other than the standard specifications or information communicated by iXblue:

- (i) The Customer acknowledges that the USV offered by iXblue and accepted by the Customer is compliant with the Customer's needs and with legal, regulatory and operational requirements applicable in the areas where the USV shall be used, and
- (ii) The Customer shall be exclusively liable for and shall indemnify and hold iXblue harmless for all consequences, including legal and financial, arising from non-compliance of the USV with any legal, regulatory and operational requirement applicable in the areas of use of the USV and which would not have been notified by the Customer to iXblue prior to conclusion of the Order.

11.4. iXblue shall provide for a training for the trainees sent by the Customer according to the conditions of iXblue's offer accepted by the Customer. In case of non-participation of the Customer to the training provided by iXblue:

- a) iXblue shall be released from all and any liability of any kind towards the Customer regarding the consequences of the lack of skill of the Customer while operating the USV after delivery, and
- b) In case of any incident after delivery resulting from the use of the USV by Customer, the Customer shall indemnify and hold iXblue harmless for all consequences of any kind (including legal and financial) arising from this aforementioned.

11.5. This article 11 shall apply notwithstanding any other contradictory or non-contradictory provision of the Order and shall survive to the termination or expiration of the Order.

ARTICLE 12 – INTELLECTUAL PROPERTY

12.1. All the intellectual property rights, existing prior to the Order or generated within the Order performance, protectable or not, related to the USV and its related services and accessories, including without limitation, rights related to studies, know-how, software, firmware, patents, schemes, models, drawings, technical descriptions, calculations, test

results and any other documents provided or not by iXblue, shall remain the sole property of iXblue.

12.2. iXblue shall grant to Customer a non-exclusive right of use of all intellectual property right belonging to iXblue for the purpose of use, operation and maintenance of the USV for the Customer's own needs. This right is not assignable and is given without right to sublicense. Any other right not expressly listed above is excluded, in particular right to commercially exploit, to distribute, to modify, to reproduce, to manufacture, or to copy for any purpose.

12.3. The Customer shall take all necessary measures in order to protect iXblue intellectual property rights integrity and confidentiality pursuant to article 20, in particular with regard to any "industrial secret" attached to technical documents, studies, information or know-how.

12.4. For the purpose of the GTCS, the word "Software(s)" means any software or firmware provided by iXblue to Customer and embedded or not within the USV. Subject to the specific provisions of the software licence associated to the concerned Software which, as the case may be, shall prevail, the Customer shall only have a right to use said Software for the sole purpose of operating the USV its own needs, to the exclusion of any other right. In particular, no source code of the Software shall be assigned or transferred to the Customer.

12.5. It shall be the Customer's exclusive responsibility to ensure that Customer's hardware and software environment is compliant and suitable for the use of the Software.

12.6. iXblue's liability shall be excluded:

- With regard to the use of Software by the Customer and of the results so generated by the Customer. The use of the Software shall be under sole and exclusive responsibility of the Customer.
- With regard to the consequences of whatever kind, resulting from a Software modification to the sole initiative of the Customer or from the integration of the Software, without iXblue's consent, within a Customer's larger hardware or software package.

ARTICLE 13 – FORCE MAJEURE

13.1. A Force majeure event shall be understood, pursuant to French law, as an unpredictable, irresistible and beyond a party's control event.

13.2. Upon occurrence of a Force Majeure event, and within a maximum period of ten (10) calendar days starting from its occurrence, the affected party shall notify the other party by registered letter with return receipt requested and indicate the circumstances, complete with any written evidence required. All the obligations affected by a Force Majeure event shall be suspended.

13.3. Should any Force Majeure event prevent either party to fulfil its contractual obligations for more than ninety (90) calendar days, starting from the abovementioned notification, and without any agreement to pursue the performance of the Order, iXblue shall be entitled to terminate the Order or any part thereof in accordance with article 14.2 below.

ARTICLE 14 – TERMINATION

14.1. In case of breach by a party of its contractual obligations, and without this breach being remedied within a period of thirty (30) calendar days from the date of a formal notice of the other party requesting to do so, the non-defaulting party shall be entitled to terminate immediately and without any further formality the concerned Order.

14.2. Upon any termination of the Order, iXblue shall be paid for the work delivered to the Customer up to the termination date and shall be reimbursed by the Customer for all the direct costs incurred because of the termination.

The amounts indicated here above are the only amounts the parties may claim in respect of the termination and no other compensation or damages may be claimed by either party from the other party, save in case of termination for default of or breach by a party where the non-breaching party shall be entitled to claim for such damages or compensation.

14.3. Without prejudice to the foregoing, it is agreed that iXblue shall recover the property of any part of the work (including the USV) delivered to the Customer and for which iXblue has reimbursed to the Customer the corresponding payments.

ARTICLE 15 – COMPLIANCE WITH LAWS AND REGULATIONS

Each party undertakes to comply with all applicable laws and regulations and in particular all the applicable laws and regulations about taxation, anti-bribery and integrity, personal data protection (in particular GDPR regulation) and health, safety and environment.

ARTICLE 16 – INDEMNIFICATION

16.1. Except in case of a gross negligence or wilful misconduct from the Customer, iXblue shall be responsible for and shall save, indemnify, defend and hold harmless the Customer from and against all claims, losses, damages, costs expenses and liabilities in respect of:

- a) Loss of or damage to property of iXblue in connection with the performance or non-performance of the Order; and
- b) Personal injury including death or disease to any person employed by iXblue arising from, relating the performance or non-performance of the Order; and
- c) damage to the property of any third party to the extent that any such injury, loss or damage is caused by the gross negligence or breach of duty (whether statutory or otherwise) of the iXblue.

16.2. Except in case of a gross negligence or wilful misconduct from iXblue, the Customer shall be responsible for and shall save, indemnify, defend and hold harmless iXblue from and against all claims, losses, damages, costs expenses and liabilities in respect of:

- a) Loss of or damage to property of the Customer (including any equipment used on board or with the USV during trials before delivery) in connection with the performance or non-performance of the Order; and
- b) Personal injury including death or disease to any person employed by the Customer arising from, relating the performance or non-performance of the Order; and
- c) Damage to the property of any third party to the extent that any such injury, loss or damage is caused by the gross negligence or breach of duty (whether statutory or otherwise) of the Customer.

16.3. Without prejudice to article 17 below, upon written request of iXblue, each party shall submit to the other party a written statement by its respective insurers that they shall have no claim and no recourse against the other party and its respective insurers for claims specified in the present clause.

ARTICLE 17 – INSURANCE

17.1. Upon delivery of the USV as per this Order, it shall be Customer's responsibility to arrange, at its own costs, the necessary insurance coverage for the USV.

17.2. The Customer shall also subscribe all the other necessary insurances to cover any kind of damage that could arise within the performance of the Order.

ARTICLE 18 – LIABILITY

18.1. Whenever related, including presumably, to any breach, act or omission of iXblue, its employees, agents, representatives or subcontractors, arising from or in any way relating to the Order, whether based on the Order, tort (including negligence), strict liability or any other legal theory:

- In no event shall iXblue, its employees, agents, representatives or subcontractors be liable for loss of contract, work interruption, loss of use, loss of data, loss of revenue, profit or anticipated savings, loss of goodwill or any indirect, special, incidental, consequential, exemplary or punitive damages, even if advised of the possibility of such losses or damages ; and,
- The maximum aggregate liability of iXblue, including its employees, agents, representatives and subcontractors, shall not exceed the total value of the Order concerned by the claim.

18.2. The aforementioned restrictions on liability are not applicable in cases of damage to third party, personal injury or death or damages resulting from any fraudulent act, wilful misconduct or gross negligence of iXblue or its employees.

ARTICLE 19 – APPLICABLE LAW AND SETTLEMENT OF DISPUTES

19.1. The interpretation, performance or non-performance of the Order and any and all matters in dispute between the Customer and iXblue, whether arising from the Order, or arising from alleged extra-contractual facts prior to, during, or subsequent to the Order, shall be governed by the laws of France, and, excluding the 11th April 1980 United Nations convention on international sales of goods.

19.2. Any dispute related to or arising from this Order, and which cannot be settled by amicable agreement within one (1) month from notification of the said dispute, shall be submitted to arbitration according to the arbitration rules of the International Chamber of Commerce (ICC). The arbitration tribunal shall be composed by three (3) arbitrators: each Party shall appoint one (1) arbitrator and the two appointed arbitrators shall appoint the third arbitrator who shall act as president of the arbitration tribunal. The arbitrators shall have to comply with all the ICC arbitration rules and the president of the arbitration tribunal shall not have the nationality of any of the Parties. The arbitration tribunal shall have its seat in Paris, France. The arbitration award shall be final and binding upon the Parties.

ARTICLE 20 – MISCELLANEOUS

20.1. Waiver

The failure, in a particular case, of iXblue to exercise or enforce any right, remedy or provision contained in the Order shall not constitute a waiver and shall not prevent iXblue from subsequently exercising any rights.

20.2. Confidentiality

Customer shall hold confidential and shall not use, disclose or permit others to use any confidential information identified as such in writing or orally by iXblue or information which the Customer knows or ought to reasonably know is confidential, proprietary or trade secret information of iXblue, including, without limitation, trade secrets embodied in the goods/USV or the related services. For this purpose, any iXblue offer is a confidential information.

20.3. Assignment

The Order shall not be assigned or otherwise transferred by the Customer (by operation of law or otherwise) without the prior written consent of iXblue.

20.4. Severability

In the event that any of the terms of the Order, become or are declared to be invalid, the parties shall remain bound by the other provisions and shall meet as soon as possible to remedy to the said invalid clauses in the same vein as when drafting the Order. All the other terms not affected shall remain in full force and effect.

20.5. No Third Party

The parties hereby confirm that no provision of the Order shall confer any benefit on, nor be enforceable, by any person (physical or legal) who is not a party to this Contract.

20.6. Entire agreement

The Order constitutes the entire agreement between the parties hereto concerning the subject matter of the Order, apart from existing non-disclosure agreements, and there are no understandings, agreements, representations, conditions, warranties, or other terms, express or implied, which are not specified herein. The Order may only be modified through amendment signed by authorized representatives of iXblue and the Customer.

20.7. Notification

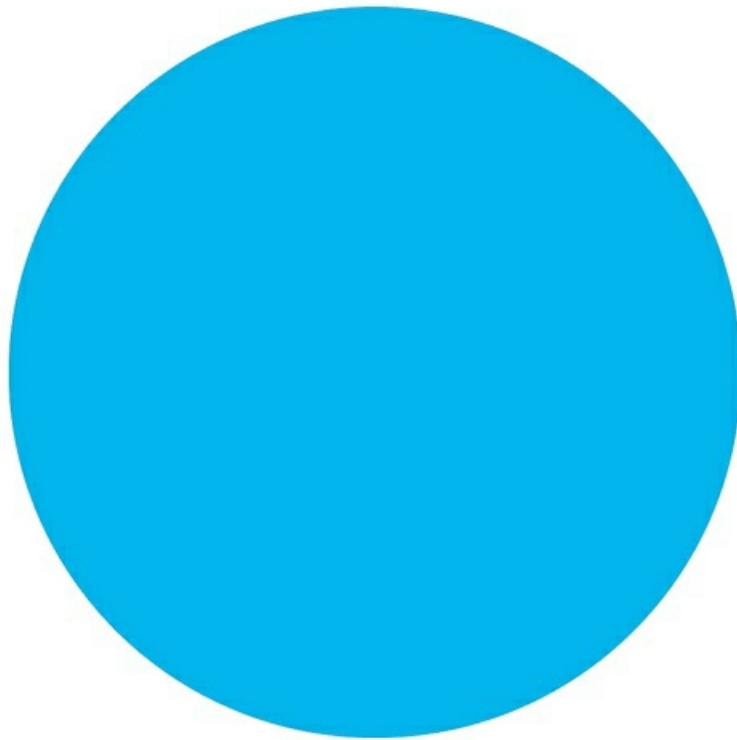
Any written communication or notification to be sent between iXblue and the Customer for the purpose of this Order shall be sent by registered letter or registered email with acknowledgement of receipt.

NAUTICUS ROBOTICS INC.

Technical offer for DriX USV

Linked to commercial offer Ref.: QU_2111_41317_1

Dated December 5, 2021



iXblue property

COMMERCIAL IN CONFIDENCE



Table of Content

1	<i>DriX Standard package</i>	3
1.1	DriX USV.....	3
1.2	DriX Deployment System (DDS).....	9
1.3	Special transportation Container.....	10
1.4	Road Trailer (<i>Not Included in the Commercial Offer</i>)	11
2	<i>DriX Options</i>	11
2.1	DRiX Certification	11
2.2	Communication & Navigation options	12
3	<i>Other LARS & Logistics systems</i>	13
3.1	DriX Offshore Platform (DOP) compatible with DDS only	13
4	<i>Training & Support (Included in Commercial Offer)</i>	13
4.1	Training.....	13
4.2	Support.....	15
5	<i>Payload Systems</i>	16
5.1	SVP automatic System	16
5.2	DriX Gondola systems.....	17
5.3	Custom Gondola option	18
5.4	Payload Integration, offset, setup and testing	19
6	<i>Payload Sensors</i>	19

1 DriX Standard package

DriX is an internationally patented system, the autonomous system is divided in various optional products and services such as:

- ✓ DRIX (USV)
- ✓ Payload systems (Gondola and sensors)
- ✓ LARS system
- ✓ Support and services.
- ✓ Options

1.1 DriX USV

1.1.1 DriX main characteristics

- **Main Dimensions**

- ✓ Length Overall (LOA): 7.7 m
- ✓ Beam: 0.82 m
- ✓ Draft: 2.0 m
- ✓ Full load displacement: 1.6 metric tons

- **DRIX USV's Performances**

- ✓ Speed range: from 3.5 to 13 knots
- ✓ Fuel capacity: 250 litres.
- ✓ Operability in sea states > 4

- **Indicative Survey performance on calm water***

- ✓ Average survey Speed: @ 8 knots > 800 Nm
- ✓ Long range survey Speed: @ 6 knots > 1000 Nm
- ✓ Fast Transit Speed: @ 12 knots > 350 Nm

**Performance may vary depending on Payloads.*



1.1.2 Technical description

- **Hull Construction (BV Classed)**

DriX is constructed out of composite materials (E-Glass, Kevlar, carbon, and epoxy Resin) using infusion process.

The hull is divided in three watertight compartments and fitted with a crash-box which can be replaced with a simple tool (requiring minimal downtime).



DriX starboard view

• **Crashbox**

DriX stem is protected with a sacrificial crashbox which is profiled to ensure efficient wave piercing effect. It is fixed on a watertight bulkhead.

The crash box can be replaced in less than 5 minutes with a simple tool.



• **Propulsion**

- ✓ 1 x 37.5 HP N4.38 Nanni Diesel engine
- ✓ 1 x ZF 25A gear box with trolling valve
- ✓ 1 x 3 blades fixed pitch propeller
- ✓ 1 x 250 liters diesel fuel tank; 1 x fixed pitch propeller mounted on a direct shaft

• **Stabilization**

- ✓ 1 x T-Foil rudder
- ✓ 1 x 2 meters draft lifting keel (fully extended during navigation and retracted within the mast when docked)
- ✓ 1 x hydrodynamically active stabilizer located on the keel profile (roll stabilizer). Roll stabilization is achieved with a servo motor slaved to the integrated iXblue PHINS C7 inertial unit.



• **Electrical power systems**

DriX electrical power is provided by two DC alternators charging a set of batteries.

- ✓ Alternators Total capacity: 2.4 kW (1.2 kW dedicated for payloads)
- ✓ Batteries total capacity: 120 Ah

- ✓ DriX is fitted with smart digital switching electrical distribution network and telemetry.
- ✓ Deck mounted Data and Shore-power plugs
- **DriX Control Station (for remote monitoring & control)**
 - ✓ One radio remote control (VHF, Wi-Fi)
 - ✓ One hardened laptop PC with Navigation & Mission planning software
 - ✓ Second hardened laptop PC (in option)

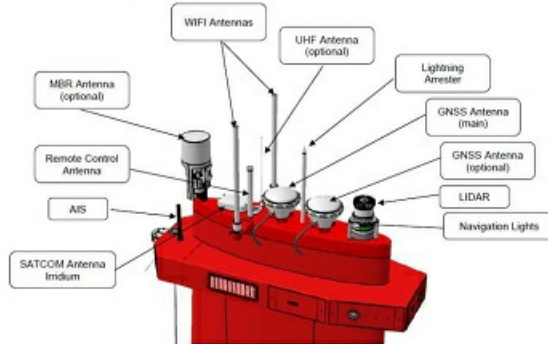


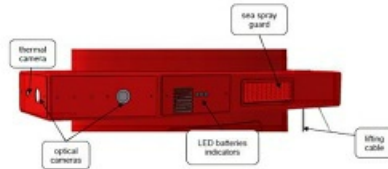
Hardened laptop PC



Radio remote control

- **Emergency Stop**
 - ✓ DriX is equipped with a safety emergency wire shut off safety system which can be manually activated with a boathook.
 - ✓ The Iridium edge recovery system is automatically started to provide the position of the DRIX while automatic shut off is activated.
- **Situational Awareness**
 - ✓ 360° HD video coverage
 - ✓ 70° frontal forward looking infrared camera
 - ✓ 360° 3D LIDAR
 - ✓ AIS emitter
 - ✓ Navigation lights
 - ✓ Working lights
 - ✓ Auto pilot for direct (remote control), semi-autonomous (mission pattern), autonomous (transit + mission pattern as per mission preparation)
 - ✓ Radar is available in option





Example of DRiX USV mast head

- **iXblue SW package for vessel operation under supervised autonomy - CORTIX**

CORTIX Autonomy is taking care of the execution of the DRiX autonomous behaviours. The autonomous behaviours configuration is done through the CORTIX user HMI.

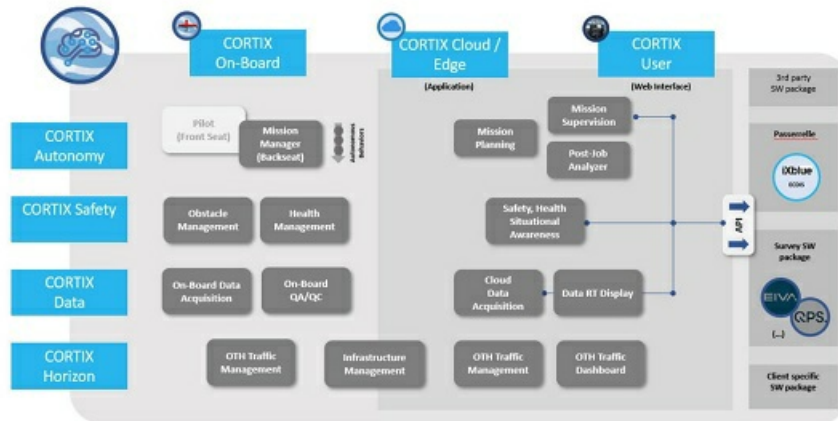
The CORTIX Autonomous behaviours are described in the following sections.

The DRiX is designed to operate with a high level of autonomy under the supervision of a human operator located remotely. The DRiX relies on the iXblue CORTIX Software (SW) framework to manage its autonomy CORTIX includes:

- ✓ CORTIX Autonomy (Mission planning and Execution)
- ✓ CORTIX Safety (Obstacle Avoidance, Vehicle Health Management)
- ✓ CORTIX Data (On-board Data Acquisition, Data QA/QC)
- ✓ CORTIX Horizon (Communication infrastructure management)

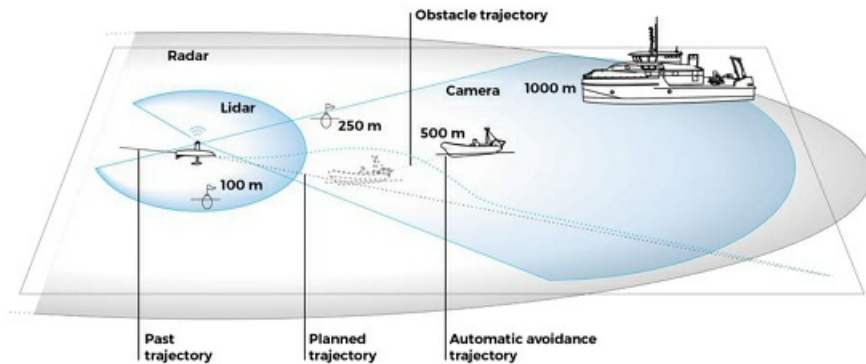
CORTIX has three deployed components:

- ✓ CORTIX On-board (Autonomy SW running on-board)
- ✓ CORTIX Cloud /Edge (Autonomy SW running on the user side either on a physical computer with no global connectivity requirement (Edge) or in the Cloud (for OTH operations).
- ✓ CORTIX User (Web based HMI, User interface for mission planning and supervision running on top of CORTIX Edge/Cloud)



- **CORTIX Autonomy** takes care of Mission planning and execution. A DriX mission is defined through a set of autonomous behaviors. The CORTIX autonomous behaviors include:
 - ✓ Stop and Hold Position – available to the operator during normal operations. The DriX will stop and hold its current position if it loses connection with the operator after an operator-defined period of time.
 - ✓ Hovering.
 - ✓ Survey Path Following (allows DriX to execute an operator defined Path).
 - ✓ Go To (a specific position on the map).
 - ✓ Exact Follow-me behavior (follow the same trajectory as the mother vessel within a minimum and maximum distance from the vessel).
 - ✓ Tracking Follow Me Behavior (follow the Mothership in tracking mode with its heading aligned with the vessel one, with an offset vs the vessel and within a minimum and maximum distance from the vessel).
 - ✓ Box In (DriX circling around a user-defined point with a user-defined radius).
 - ✓ Auto Docking in Launch and Recovery System (DDS or UDS).

The Autonomous behaviors are parametrized by the user through the CORTIX User interface. The user can define Exclusion Zones. CORTIX can be interfaced with a WMS Chart Server as a service to distribute ENC (Electronic Nautical Chart) files to the CORTIX deployed components.



• **On board Communications**

DriX is fitted with a range of complementary communications systems to allow the monitoring and control in any mode of operation including Wi-Fi for short range and satellite comms for over the horizon operations.

Standard

- ✓ 360° radio coverage (Line of Sight) / (Radio / WIFI / LTE)
- ✓ Recovery back up: IRIDIUM Edge (low bandwidth OTH) (Iridium subscription not included)

Optional

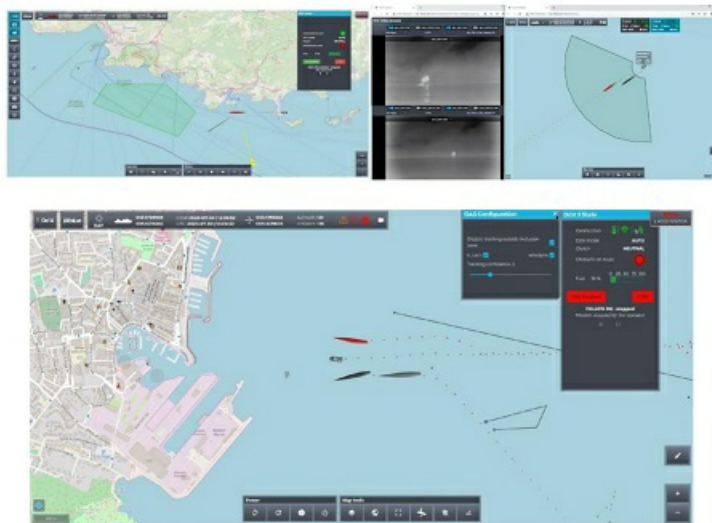
- ✓ Extra range UHF: Kongsberg Maritime Broadband Radio (MBR)
- ✓ Over the Horizon (OTH): Satcom (High Bandwidth) Iridium Certus



Indicative Communication system range

Mission System

- ✓ 1 x CORTIX Software suite for mission planning, execution and supervision as described above
- ✓ The DriX includes a Survey computer free of use for 3rd party software package such as QINCY QPS, EIVA, HIPACK, ... (Licenses not included)
- ✓ 1 x Obstacle Avoidance System as part of CORTIX OAS
- ✓ 1 x integrated inertial navigation System (INS) reference: iXblue Phins C7
- ✓ 1 x payload electronic cabinet for equipment control 1 x Mother vessel Wi-Fi station (second station optional)



Mission system software

- **Maintenance Kit**

All the necessary consumables parts and special tools (except oils) to maintain DriX operational over a year (3000 hours) in operations are included with DriX USV and can be reviewed in Section 1 of the Commercial Offer Ref: QU_2111_41317- iXblue USV DriX Nauticus Robotics.

Spares parts package is included in this offer and can be reviewed in Section 1 of the Commercial Offer Ref: QU_2111_41317-iXblue USV DriX Nauticus Robotics. This can also be adapted to customer needs depending on operational environment.

1.2 DriX Deployment System (DDS)

The DriX Deployment System (DDS) is the DriX Launch and Recovery System. It is both used as a lifting device (Bureau Veritas Certified under the “Loose Gear & Lifting Accessory” section) to deploy and retrieve a DriX from the water, and a protective shelter when DriX is inside.



DDS with single lifting point

The DDS is fitted with:

- ✓ 1 x iXblue Quadrans gyrocompass AHRS
- ✓ 1 x GNSS system (subscription for correction services not included)
- ✓ 1 x GNSS antenna
- ✓ 1 x Programmable Logic Controller (locking and unlocking of the DriX when inside the DDS)

- **Main characteristics**

- ✓ Length : 8.8 m
- ✓ Width : 2.3 m
- ✓ Height under lifting point : 4.52 m
- ✓ Material : Glass / Carbon / Epoxy
- ✓ Weight : 1200 kg
- ✓ Maximum payload : 1500 kg



All the maintenance on DriX can be done whilst DriX is stored inside the DDS. It can be used onboard a vessel, or even on the road, with DriX and its DDS on a trailer.

From the navigator point of view, DriX will be recovered in the same spirit as a RHIB would. The DDS remains attached to the crane, Davit or A-frame, and the DriX steps inside, manually or autonomously (user's choice). Once it is secured inside the DDS, the DDS is lifted back onboard.



DriX inside its DDS on a davit

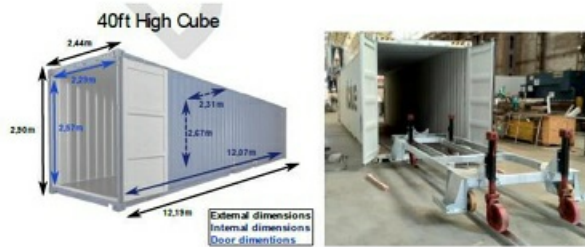
The DDS comes with **one or two (optional) lifting points** to be defined prior to order, and can be used from a Davit, an A-frame or a Crane. *This is also mentioned in Section 1 of the Commercial Offer Ref: QU_2111_41317-ixblue USV DriX Nauticus Robotics.docx. Price Upon request.*

1.3 Special transportation Container

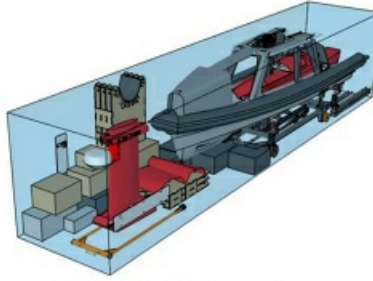
Because DriX is likely to be shipped around internationally, iXblue developed a sliding cart designed to store the DriX and its deployment system inside a 40-foot hi-cube Container. The entire DriX package holds into that container.

External Dimensions: Length: 12192 mm / Width : 2438 mm / Height: 2896 mm

Included in the Commercial Offer Ref: QU_2111_41317-ixblue USV DriX Nauticus Robotics.docx refer to Section 1.



DriX Special Transportation Container



Container DriX+DDS+Spare parts

1.4 Road Trailer (Not Included in the Commercial Offer)

One 4 wheel axle US Made Road trailer consists of ;

- ✓ 26 feet
- ✓ 14,000 Lb G.V.W.R
- ✓ 7,000 Lb x 2 G.A.W.R



Example of DriX and its DDS siting on a trailer

2 DriX Options

2.1 DRIX Certification

DriX can be delivered with a construction certificate from an IACS company such as Bureau Veritas, or Lloyds. This certificate will cover the following items:

- ✓ Hull structure
- ✓ Stability
- ✓ Control system
- ✓ Electrical systems
- ✓ Navigation systems
- ✓ Propulsion and maneuvering
- ✓ Fire
- ✓ Auxiliary systems

• **Bureau Veritas (BV) Certification**

**I ♦ HULL
SPECIAL SERVICE**

Including:

- ✓ Construction visits for Hull on construction site
- ✓ Intact stability booklet verification
- ✓ Risk analysis examination HAZID & FMEA
- ✓ Final weight experiment and stability test
- ✓ Tests and sea trials
- ✓ Delivery of class Certificate
- ✓ Delivery of approval in principle (AIP) under BV's Marine & Offshore NI641

2.2 Communication & Navigation options

2.2.1 MBR 144 (Included in Commercial Offer)

The Maritime Broadband Radio from Kongsberg is a smart antenna designed for use in maritime applications where digital high-speed reliable communication and data transfer is crucial for efficient and safe operations. Completely enclosed with integrated antennas the MBR 144 is designed for installations on small manned and unmanned vessels. The unit has an integrated bracket for easy installation on vertical or horizontal rails, and with built-in GNSS sensor, the unit has possibility for absolute positioning. With its neat and slim design, and only one cable to connect, the MBR 144 is easy to deploy on the vessel.

2.2.2 MBR 179 (mother vessel- Not Included in Commercial Offer)

The Maritime Broadband Radio is a smart antenna designed for use in any application where resilient high-speed communication and high-capacity data transfer are crucial for efficient and safe operation. With beamforming the MBR 179 provides steerable high-gain antenna direction in an omnidirectional sector, ideal for vessels and moving assets. With narrow fan shaped antenna diagram, a strong link margin is maintained and continuously updated as the unit is unaffected of vessel movements.

2.2.3 Over the Horizon (OTH) SATCOM OPTION (Included in Commercial Offer)



- Iridium Certus Thales VesseLINK 350
- Antenna and transceiver are installed on DRIX
- Antenna is mounted on a transom dedicated mast to avoid shadowing effect and avoid green water areas.
- ✓ License for communication plan is not included in the option.

2.2.4 Radar (Included in Commercial Offer)

A radome radar is installed forward of the Mast on a dedicated support.



Model: SIMRAD Halo 20+. (36 Nm)
HALO20+ radar delivers a full 360-degree sweep every second, thanks to its industry-first 60 rpm rotation at ranges up to 1.5 nautical miles. These updates give operators an almost real-time view at close range – offering collision avoidance of fast-moving targets. High-quality short-, mid- and long-range detection.



MARPA Target Tracking & Velocity-Track Doppler technology.

3 Other LARS & Logistics systems

3.1 DriX Offshore Platform (DOP) compatible with DDS only

(Not Included in Commercial Offer)

In order to simplify the daily use of DriX at sea onboard a vessel work-deck, iXblue developed an offshore DriX working station. This half-height 20 ft equivalent transformer container unfolds into a working bench and a deck cradle to work on DriX.



DriX Deployable Workbench

4 Training & Support (Included in Commercial Offer)

4.1 Training

DriX supervisor training has been externalized to a third-party specialized company.

Those involved in projects with DriX must provide qualified personnel to operate it. A DriX Supervisor certification is issued after completion of on iXblue's official training; a program articulated in two parts:

- ✓ The theoretical part, mainly consisting of text lessons, videos, presentations, quizzes, etc. as published on an e-learning platform
- ✓ The practical part, where the theoretical concepts, will be put to test via hands-on experience in a training facility with an instructor and other domain specialists.



Drix Supervisor Course

iXblue Official Training Course for DriX



Hundreds of lessons in rich content format to make you explore all there is to know about DriX.

Followed by 6 days of instructor-led hands-on training.



This was designed to help participants build the knowledge needed to understand how to operate, deploy, store and transport DriX, but also to be able to troubleshoot, make some repairs, diagnose problems and make preventive maintenance.

A personal certificate is issued following an examination at the end of the complete training session.

4.1.1 E-learning

The **Theory Session** of the course, online study, and covers 16 topics (about 80 hours):

- ✓ DriX General Presentation
- ✓ Telecommunications equipment
- ✓ Cameras and Lidar
- ✓ Internal Sensors
- ✓ Actuators
- ✓ Survey Equipment - Payload Integration
- ✓ Remote Control
- ✓ Programmable Logic Controller (PLC)
- ✓ The Electrical Architecture
- ✓ Human-Machine Interface (HMI)
- ✓ Piloting
- ✓ The Diesel Engine
- ✓ Mobilization/Demobilization and Transport
- ✓ Launch and Recovery
- ✓ Preventive Maintenance
- ✓ Composite Repairs

For more information on the syllabus, please refer to each section online on the public [home page](https://www.elearn.education/courses/DriX-pilot) for the course (<https://www.elearn.education/courses/DriX-pilot>).

Extra e-learning access can be open for people who are not taking part of the Full training. E-learning only will not be eligible for DriX Training Certificate.

4.1.2 Practical sessions

The **Practical Session** of the course (held in La Ciotat - France) lasts 6 days and is run in small groups (4 people). After completing the theory modules online, instructor-led hands-on training will cover all practical aspects of:

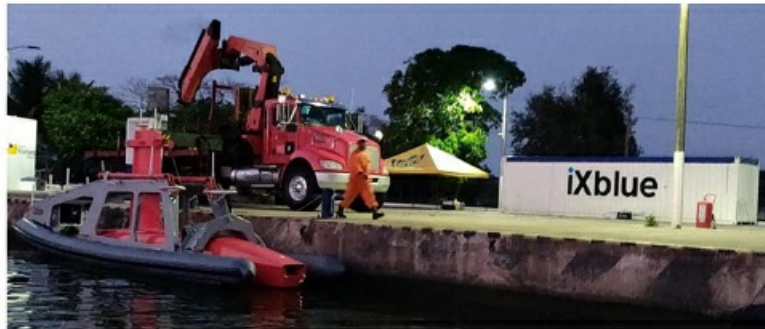
- ✓ Piloting at sea (manual piloting and auto-piloting + Exam)
- ✓ DriX Deployment
- ✓ Containerization & Transport
- ✓ Payload Integration
- ✓ Electric circuitry
- ✓ Composite repairs
- ✓ Maintenance
- ✓ DriX engine
- ✓ Diagnosis

Details on training conditions:

- Full training on DriX package for four (4) people in La Ciotat Shipyards, France
- From that basis, extra cost applies for any additional personal.
- Transports, board and lodging of trainees are not included in that price

4.2 Support

Our qualified teams of hydrographers and geophysicists are available to support our customers during their initial hydrographic surveys with the DriX. From data acquisition all the way to the processing and reporting phases, our team of professional surveyors are available at every step should there be any need for additional guidance after the training.

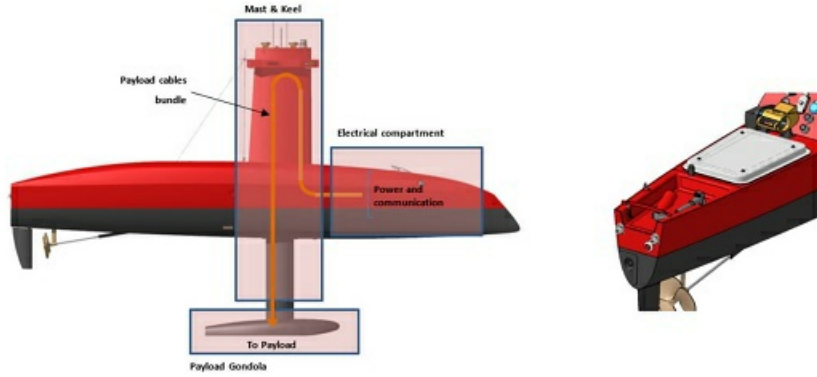


Full DriX package in operation

5 Payload Systems

DriX is ready to receive various mission payload systems including:

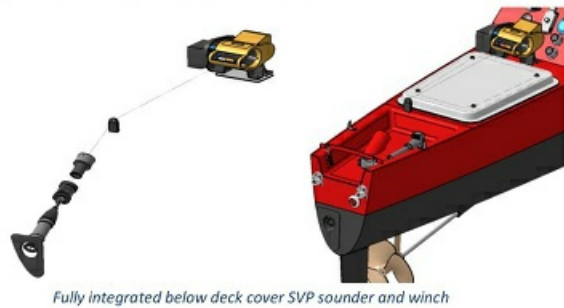
- One underway profiling winch for SVP or CTD fully integrated deck system.
- One underwater gondola (various standard design or custom designs)
- One electronic compartment (fitting up to 3U, 19")



5.1 SVP automatic System (Not Included refer to section 2 in the Commercial Offer, Ref: QU_2111_41317-ixblue USV DriX Nauticus Robotics.docx)

DriX can perform its SVP castings autonomously if needed, thanks to this optional Automatic Sound Velocity Profiler system. It includes the SVP launch and recovery winch system from the DriX for shallow water.

Note: DriX must be in Idle mode to use the SVP sounder.



5.2 DriX Gondola systems

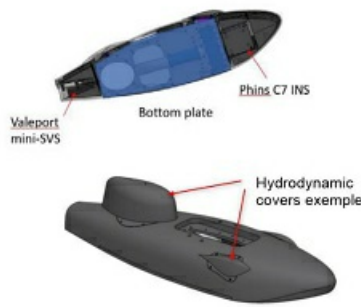
A gondola is an underwater system specifically designed to reduce the noise and increase the data quality. It is located 2 meters below the water surface. The DriX structure and the gondola shape are designed as to reduce the acoustic and hydrodynamic noises as well as to prevent the formation of air bubbles at the surface of payload equipment.

Combining the DriX Best in Class line keeping capabilities, the low noise, and the controlled motion for bathymetric survey operation the post-processing time requirement is drastically reduced.

All Gondola are specifically designed using CFD software to optimize the hydrodynamic performances and reduce the noise. The Gondolas are designed to accommodate various payloads configurations. Custom gondola can be supplied and is proposed in the Commercial offer under DriX Payload Systems.

The Gondola bottom plate is divided in three areas:

- ✓ Aft area is pre-engineered to integrate a Valeport Mini-SVS sensor, included in the Commercial Offer (refer to section 2, Ref: QU_2111_41317-ixblue USV DriX Nauticus Robotics.docx)
- ✓ Middle area is swappable Payload bottom plate receiving various payloads
- ✓ Forward area is fitted with the Inertial Navigation System PHINS C7 from iXblue.



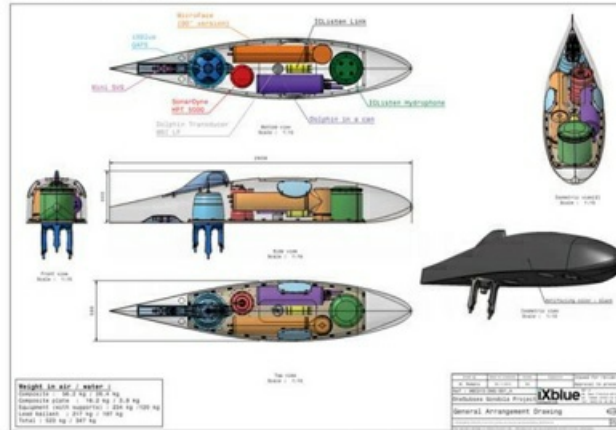
The bottom payload interface plate can be switch from a shore base or from a ship using pre-installed cables connected to the payload compartment.

5.3 Custom Gondola option

Specific gondolas can be tailor-made to the customer requirements and will be priced accordingly.

Note: Refer to section 2, of the Commercial Offer Ref: QU_2111_41317-ixblue USV DriX Nauticus Robotics.docx for pricing details on payload package included.

CUSTOM GONDOLA DRAFT EXAMPLE



Payload Summary example

<i>Equipment / Transducers</i>	<i>Supplied by</i>	<i>Fitted by</i>	<i>Cables provided by</i>
Valeport mini SVS	iXblue	iXblue	iXblue
iXblue Phins C7	iXblue	iXblue	iXblue
iXblue GAPS 7	iXblue	iXblue	iXblue
DOLPHIN	Customer	iXblue	Customer
SUBNERO	Customer	iXblue	Customer



Example of a custom-made gondola (including GAPS USBL)

5.4 Payload Integration, offset, setup and testing

Client payload to be installed as per request and set procedures. Any specific installation steps requiring attention or with potential impact on equipment integrity must be communicated to iXblue prior to installation. iXblue might require client assistance and personnel for payload gondola integration depending on its own risk assessment.

iXblue will provide the cables between the gondola and the DriX electrical compartment. Cables used to connect client provided equipment within the gondola is not defined at present (customer responsibility) and therefore not included in the offer.

The payload integration includes:

- ✓ Processor unit installation inside DriX electronic compartment.
- ✓ Wiring of payloads between Electronics compartment and underwater sensors.
- ✓ Offset measurements
- ✓ Setup and trials of payload system

• **Notes**

- ✓ iXblue standard Factory Acceptance Test procedures will cover all of DriX core functionalities (test coverage available on demand)
- ✓ Able to demonstration of communication with client Payload equipment from Survey PC to equipment (IP Ping or via customer provided Software)

6 Payload Sensors

Description of payload sensors included in this DriX USV package, priced accordingly under section under 2 of the Commercial Offer *Ref: QU_2111_41317-ixblue USV DriX Nauticus Robotics.docx*

Sensor description	
<i>Equipment / Transducers</i>	<i>Datasheet</i>
Valeport mini SVS	Link to datasheet
iXblue GAPS M7	Link to datasheet
iXblue Oceano MT912S-R	Link to datasheet

CERTAIN IDENTIFIED INFORMATION HAS BEEN EXCLUDED FROM THIS EXHIBIT BECAUSE IT IS BOTH NOT MATERIAL AND IS THE TYPE THAT THE REGISTRANT TREATS AS PRIVATE OR CONFIDENTIAL.

AWARD/CONTRACT		1. THIS CONTRACT IS A RATED ORDER UNDER DPAS (15 CFR 700)		RATING	PAGE OF PAGES 1 80	
2. CONTRACT (Proc. Inst. Ident.) NO. [REDACTED]		3. EFFECTIVE DATE 30 Aug 2021		4. REQUISITION/PURCHASE REQUEST /PROJECT NO.		
5. ISSUED BY DEFENSE INNOVATION UNIT 230 RT JONES RD MOUNTAIN VIEW CA 94043		CODE HQ0845	6. ADMINISTERED BY (If other than Item 5) See Item 5			
7. NAME AND ADDRESS OF CONTRACTOR (No. street, city, county, state and zip code) HOUSTON MECHATRONICS, NC. HMI REGINALD B. BERKA 17146 FEATHERCRAFT LANE, STE 450 WEBSTER TX 77598-4364			8. DELIVERY <input type="checkbox"/> FOB ORIGIN <input checked="" type="checkbox"/> OTHER (See below)		9. DISCOUNT FOR PROMPT PAYMENT	
CODE 7LK31			FACILITY CODE		10. SUBMIT INVOICES (4 copies unless otherwise specified) TO THE ADDRESS SHOWN IN: ITEM	
11. SHIP TO/MARK FOR See Schedule		CODE	12. PAYMENT WILL BE MADE BY DFAS-COMWEST ENTITLEMENT OPERATIONS PO BOX 182317 COLUMBUS OH 43218-2317 CODE HQ0339			
13. AUTHORITY FOR USING OTHER THAN FULL AND OPEN COMPETITION: <input type="checkbox"/> 10 U.S.C. 2304(c)() <input type="checkbox"/> 41 U.S.C. 253(c)()			14. ACCOUNTING AND APPROPRIATION DATA See Schedule			
15A. ITEM NO.	15B. SUPPLIES/ SERVICES	15C. QUANTITY	15D. UNIT	15E. UNIT PRICE	15F. AMOUNT	
SEE SCHEDULE						
15G. TOTAL AMOUNT OF CONTRACT						
16. TABLE OF CONTENTS						
(X)	SEC	DESCRIPTION	PAGE(S)	(X)	SEC	DESCRIPTION
PART I - THE SCHEDULE				PART II - CONTRACT CLAUSES		
X	A	SOLICITATION/ CONTRACT FORM	1	I		CONTRACT CLAUSES
X	B	SUPPLIES OR SERVICES AND PRICES/ COSTS	2 - 13	PART III - LIST OF DOCUMENTS, EXHIBITS AND OTHER ATTACH.		
	C	DESCRIPTION/ SPECS/ WORK STATEMENT		J		LIST OF ATTACHMENTS
	D	PACKAGING AND MARKING		PART IV - REPRESENTATIONS AND INSTRUCTIONS		
X	E	INSPECTION AND ACCEPTANCE	14	K		REPRESENTATIONS, CERTIFICATIONS AND OTHER STATEMENTS OF OFFERORS
X	F	DELIVERIES OR PERFORMANCE	15 - 16	L		INSTRS. CONDS. AND NOTICES TO OFFERORS
X	G	CONTRACT ADMINISTRATION DATA	17	M		EVALUATION FACTORS FOR AWARD
X	H	SPECIAL CONTRACT REQUIREMENTS	18 - 80			
CONTRACTING OFFICER WILL COMPLETE ITEM 17 (SEALED BID OR NEGOTIATED PROCUREMENT) OR 18 (SEALED BID PROCUREMENT) AS APPLICABLE						
17 <input type="checkbox"/> CONTRACTOR'S NEGOTIATED AGREEMENT (Contractor is required to sign this document and return copies to issuing office) Contractor agrees to furnish and deliver all items or perform all the services set forth or otherwise identified above and on any continuation sheets for the consideration stated herein. The rights and obligations of the parties to this contract shall be subject to and governed by the following documents: (a) this award/contract, (b) the solicitation, if any, and (c) such provisions, representations, certifications, and specifications, as are attached or incorporated by reference herein. (Attachments are listed herein.)				18 <input type="checkbox"/> SEALED-BID AWARD (Contractor is not required to sign this document) Your bid on Solicitation Number _____ including the additions or changes made by you which additions or changes are set forth in full above, is hereby accepted as to the terms listed above and on any continuation sheets. This award consummates the contract which consists of the following documents: (a) the Government's solicitation and your bid, and (b) this award/contract. No further contractual document is necessary. (Block 18 should be checked only when awarding a sealed-bid contract.)		
19A. NAME AND TITLE OF SIGNER (Type or print) Reginald B. Berka, Chief Operating Officer				20A. NAME OF CONTRACTING OFFICER [REDACTED]		
19C. DATE SIGNED September 1, 2021				20B. UNITED STATES OF AMERICA [REDACTED] <i>(Signature of Contracting Officer)</i>		20C. DATE SIGNED 30-Aug-2021

Previous edition is NOT usable

STANDARD FORM 26 (REV 5/2011)
Prescribed by GSA - FAR (48 CFR) 53.214(a)

Section B - Supplies or Services and Prices

ITEM NO	SUPPLIES/SERVICES	QUANTITY	UNIT	UNIT PRICE	AMOUNT
0001	Kick-off Meeting FFP Kick-off Meeting FOB: Destination MFR PART NR: 000 1353	1	Each	██████████	██████████
					██████████
				NET AMT	██████████
	ACRN AA CIN: ██████████				██████████

ITEM NO	SUPPLIES/SERVICES	QUANTITY	UNIT	UNIT PRICE	AMOUNT
0002	Data Collection Event 1 FFP Data Collection Event 1 FOB: Destination MFR PART NR: 000 1353	1	Each	██████████	██████████
					██████████
				NET AMT	██████████
	ACRN AA CIN: ██████████				██████████



ITEM NO	SUPPLIES/SERVICES	QUANTITY	UNIT	UNIT PRICE	AMOUNT
0003	Data Collection Event 2 FFP Data Collection Event 2 FOB: Destination MFR PART NR: 000 1353	1	Each	[REDACTED]	[REDACTED]
				NET AMT	[REDACTED]
ACRN AA					[REDACTED]
CIN: [REDACTED]					[REDACTED]

ITEM NO	SUPPLIES/SERVICES	QUANTITY	UNIT	UNIT PRICE	AMOUNT
0004	Object Perception Demonstration FFP Object Perception Demonstration FOB: Destination MFR PART NR: 000 1353	1	Each	[REDACTED]	[REDACTED]
				NET AMT	[REDACTED]
ACRN AA					[REDACTED]
CIN: [REDACTED]					[REDACTED]

ITEM NO	SUPPLIES/SERVICES	QUANTITY	UNIT	UNIT PRICE	AMOUNT NSP
0005	Monthly Reporting FFP Monthly Reporting (at the completion of all) FOB: Destination MFR PART NR: 000 1353				
NET AMT					

ITEM NO	SUPPLIES/SERVICES	QUANTITY	UNIT	UNIT PRICE	AMOUNT NSP
0006	Bi-Weekly Update Calls FFP Bi-Weekly Update Calls (at completion of all) FOB: Destination MFR PART NR: 000 1353				
NET AMT					

ITEM NO	SUPPLIES/SERVICES	QUANTITY	UNIT	UNIT PRICE	AMOUNT
0007 OPTION	Preliminary Design Review FFP Preliminary Design Review FOB: Destination MFR PART NR: 000 1353	1	Each	██████████	██████████
NET AMT					██████████

ITEM NO	SUPPLIES/SERVICES	QUANTITY	UNIT	UNIT PRICE	AMOUNT
0008 OPTION	Critical Design Review FFP Critical Design Review FOB: Destination MFR PART NR: 000 1353	1	Each	██████████	██████████
				NET AMT	██████████

ITEM NO	SUPPLIES/SERVICES	QUANTITY	UNIT	UNIT PRICE	AMOUNT
0009 OPTION	Hardware in the Loop Demonstration FFP Hardware in the Loop Demonstration FOB: Destination MFR PART NR: 000 1353	1	Each	██████████	██████████
				NET AMT	██████████

ITEM NO	SUPPLIES/SERVICES	QUANTITY	UNIT	UNIT PRICE	AMOUNT
0010 OPTION	Tethered Autonomy Demonstration FFP Tethered Autonomy Demonstration FOB: Destination MFR PART NR: 000 1353	1	Each	████████	████████

NET AMT ██████████

ITEM NO	SUPPLIES/SERVICES	QUANTITY	UNIT	UNIT PRICE	AMOUNT
0011 OPTION	Untethered Autonomy Demonstration 1 FFP Untethered Autonomy Demonstration 1 FOB: Destination MFR PART NR: 000 1353	1	Each	████████	████████

NET AMT ██████████

ITEM NO	SUPPLIES/SERVICES	QUANTITY	UNIT	UNIT PRICE	AMOUNT
0012 OPTION	Interface Control Document Delivery FFP Interface Control Document Delivery FOB: Destination MFR PART NR: 000 1353	1	Each	████████	████████

NET AMT ██████████

ITEM NO	SUPPLIES/SERVICES	QUANTITY	UNIT	UNIT PRICE	AMOUNT
0013 OPTION	Environmental Testing Support FFP Environmental Testing Support FOB: Destination MFR PART NR: 000 1353	1	Each	██████████	██████████

NET AMT ██████████

ITEM NO	SUPPLIES/SERVICES	QUANTITY	UNIT	UNIT PRICE	AMOUNT
0014 OPTION	UMMA Compliance Report Delivery FFP UMMA Compliance Report Delivery FOB: Destination MFR PART NR: 000 1353	1	Each	██████████	██████████

NET AMT ██████████



ITEM NO	SUPPLIES/SERVICES	QUANTITY	UNIT	UNIT PRICE	AMOUNT	
0015 OPTION	ATR Expansion 1 FFP ATR Expansion 1 FOB: Destination MFR PART NR: 000 1353	1	Each	████████	████████	
					NET AMT	████████

ITEM NO	SUPPLIES/SERVICES	QUANTITY	UNIT	UNIT PRICE	AMOUNT	
0016 OPTION	ATR Expansion 2 FFP ATR Expansion 2 FOB: Destination MFR PART NR: 000 1353	1	Each	████████	████████	
					NET AMT	████████

ITEM NO	SUPPLIES/SERVICES	QUANTITY	UNIT	UNIT PRICE	AMOUNT	
0017 OPTION	ATR Expansion 3 FFP ATR Expansion 3 FOB: Destination MFR PART NR: 000 1353	1	Each	████████	████████	
					NET AMT	████████

ITEM NO	SUPPLIES/SERVICES	QUANTITY	UNIT	UNIT PRICE	AMOUNT
0018 OPTION	Untethered Demonstration 2 FFP Untethered Demonstration 2 - Prices for this CLIN are subject to the Government's future definitized requirements. Final prices shall not exceed the unit price shown herein. FOB: Destination MFR PART NR: 000 1353	1	Each	[REDACTED]	[REDACTED] NTE

NET AMT

[REDACTED]

ITEM NO	SUPPLIES/SERVICES	QUANTITY	UNIT	UNIT PRICE	AMOUNT
0019 OPTION	Sensor Payload 1 FFP Sensor Payload 1 -- Prices for this CLIN are subject to the Government's future definitized requirements. Final prices shall not exceed the unit price shown herein. FOB: Destination MFR PART NR: 000 1353	1	Each	[REDACTED]	[REDACTED] NTE

NET AMT

[REDACTED]

ITEM NO	SUPPLIES/SERVICES	QUANTITY	UNIT	UNIT PRICE	AMOUNT
0020 OPTION	Sensor Payload 2 FFP Sensor Payload 2 -- Prices for this CLIN are subject to the Government's future definitized requirements. Final prices shall not exceed the unit price shown herein. FOB: Destination MFR PART NR: 000 1353	1	Each	[REDACTED]	[REDACTED] NTE

NET AMT [REDACTED]

ITEM NO	SUPPLIES/SERVICES	QUANTITY	UNIT	UNIT PRICE	AMOUNT
0021 OPTION	Sensor Payload 3 FFP Sensor Payload 3 - Prices for this CLIN are subject to the Government's future definitized requirements. Final prices shall not exceed the unit price shown herein. FOB: Destination MFR PART NR: 000 1353	1	Each	[REDACTED]	[REDACTED] NTE

NET AMT [REDACTED]

ITEM NO	SUPPLIES/SERVICES	QUANTITY	UNIT	UNIT PRICE	AMOUNT
0022		1	Each	██████████	██████████
OPTION	Communication Payload Integration 1 FFP Communication Payload Integration 1- Prices for this CLIN are subject to the Government's future definitized requirements. Final prices shall not exceed the unit price shown herein. FOB: Destination MFR PART NR: 000 1353				NTE

NET AMT

██████████

ITEM NO	SUPPLIES/SERVICES	QUANTITY	UNIT	UNIT PRICE	AMOUNT
0023		1	Each	██████████	██████████
OPTION	Engineering Services 1 FFP Engineering Services 1- Prices for this CLIN are subject to the Government's future definitized requirements. Final prices shall not exceed the unit price shown herein. FOB: Destination MFR PART NR: 000 1353				NTE

NET AMT

██████████

ITEM NO	SUPPLIES/SERVICES	QUANTITY	UNIT	UNIT PRICE	AMOUNT
0024	Engineering Services 2	1	Each	[REDACTED]	[REDACTED]
OPTION	FFP				NTE
	Engineering Services 2 - Prices for this CLIN are subject to the Government's future definitized requirements. Final prices shall not exceed the unit price shown herein.				
	FOB: Destination				
	MFR PART NR: 000				
	1353				

NET AMT [REDACTED]

ITEM NO	SUPPLIES/SERVICES	QUANTITY	UNIT	UNIT PRICE	AMOUNT
0025	Engineering Services 3	1	Each	[REDACTED]	[REDACTED]
OPTION	FFP				NTE
	Engineering Services 3 - Prices for this CLIN are subject to the Government's future definitized requirements. Final prices shall not exceed the unit price shown herein.				
	FOB: Destination				
	MFR PART NR: 000				
	1353				

NET AMT [REDACTED]

ITEM NO	SUPPLIES/SERVICES	QUANTITY	UNIT	UNIT PRICE	AMOUNT
0026	Two (2) Prototypes Delivery	1	Each	[REDACTED]	[REDACTED]
OPTION	FFP Two (2) Prototypes Delivery - Prices for this CLIN are subject to the Government's future definitized requirements. Final prices shall not exceed the unit price shown herein. FOB: Destination MFR PART NR: 000 1353				NTE
				NET AMT	[REDACTED]

ITEM NO	SUPPLIES/SERVICES	QUANTITY	UNIT	UNIT PRICE	AMOUNT
0027	Operator & Maintainer Training	1	Each	[REDACTED]	[REDACTED]
OPTION	FFP Operator & Maintainer Training - Prices for this CLIN are subject to the Government's future definitized requirements. Final prices shall not exceed the unit price shown herein. FOB: Destination MFR PART NR: 000 1353				NTE
				NET AMT	[REDACTED]

Section E - Inspection and Acceptance

INSPECTION AND ACCEPTANCE TERMS

Supplies/services will be inspected/accepted at:

CLIN	INSPECT AT	INSPECT BY	ACCEPT AT	ACCEPT BY
0001	Destination	Government	Destination	Government
0002	Destination	Government	Destination	Government
0003	Destination	Government	Destination	Government
0004	Destination	Government	Destination	Government
0005	Destination	Government	Destination	Government
0006	Destination	Government	Destination	Government
0007	Destination	Government	Destination	Government
0008	Destination	Government	Destination	Government
0009	Destination	Government	Destination	Government
0010	Destination	Government	Destination	Government
0011	Destination	Government	Destination	Government
0012	Destination	Government	Destination	Government
0013	Destination	Government	Destination	Government
0014	Destination	Government	Destination	Government
0015	Destination	Government	Destination	Government
0016	Destination	Government	Destination	Government
0017	Destination	Government	Destination	Government
0018	Destination	Government	Destination	Government
0019	Destination	Government	Destination	Government
0020	Destination	Government	Destination	Government
0021	Destination	Government	Destination	Government
0022	Destination	Government	Destination	Government
0023	Destination	Government	Destination	Government
0024	Destination	Government	Destination	Government
0025	Destination	Government	Destination	Government
0026	Destination	Government	Destination	Government
0027	Destination	Government	Destination	Government

Section F - Deliveries or Performance

DELIVERY INFORMATION

CLIN	DELIVERY DATE	QUANTITY	SHIP TO ADDRESS	DODAAC / CAGE
0001	05-SEP-2021	1	N/A FOB: Destination	
0002	23-SEP-2021	1	N/A FOB: Destination	
0003	15-NOV-2021	1	N/A FOB: Destination	
0004	15-DEC-2021	1	N/A FOB: Destination	
0005	15-JAN-2022		N/A FOB: Destination	
0006	15-JAN-2022		N/A FOB: Destination	
0007	N/A	N/A	N/A	N/A
0008	N/A	N/A	N/A	N/A
0009	N/A	N/A	N/A	N/A
0010	N/A	N/A	N/A	N/A
0011	N/A	N/A	N/A	N/A
0012	N/A	N/A	N/A	N/A
0013	N/A	N/A	N/A	N/A
0014	N/A	N/A	N/A	N/A
0015	N/A	N/A	N/A	N/A
0016	N/A	N/A	N/A	N/A
0017	N/A	N/A	N/A	N/A
0018	N/A	N/A	N/A	N/A
0019	N/A	N/A	N/A	N/A
0020	N/A	N/A	N/A	N/A

0021	N/A	N/A	N/A	N/A
0022	N/A	N/A	N/A	N/A
0023	N/A	N/A	N/A	N/A
0024	N/A	N/A	N/A	N/A
0025	N/A	N/A	N/A	N/A
0026	N/A	N/A	N/A	N/A
0027	N/A	N/A	N/A	N/A

Section G - Contract Administration Data

ACCOUNTING AND APPROPRIATION DATA

[REDACTED]

AMOUNT: [REDACTED]

ACRN	CLIN/SLIN	CIN	AMOUNT
AA	0001	[REDACTED]	[REDACTED]
	0002	[REDACTED]	[REDACTED]
	0003	[REDACTED]	[REDACTED]
	0004	[REDACTED]	[REDACTED]



Section H - Special Contract Requirements

AGREEMENT NO. HQ08452190031

OTHER TRANSACTION FOR PROTOTYPE AGREEMENT

between

The United States Government
Defense Innovation Unit
230 R.T. Jones Rd
Mountain View, CA 94043

and

Houston Mechatronics Inc
17146 Feathercraft Ln Suite 450 Webster, Texas
DUNS Number: 079574594
CAGE: 7LK31

Agreement No.: [REDACTED]

Effective Date: See SF26 Block 3, Agreement

This Agreement is entered into between the United States of America, represented by Defense Innovation Unit, hereinafter called Government and Houston Mechatronics Inc, hereinafter called COMPANY, pursuant to 10 U.S.C. §2371b and under United States Federal law. Government and COMPANY are collectively referred to as the "Parties."

TABLE OF CONTENTS

ARTICLE 1: DEFINITIONS
ARTICLE 2: SCOPE OF THE AGREEMENT
ARTICLE 3: TERM OF THE AGREEMENT AND TERMINATION
ARTICLE 4: MANAGEMENT, ADMINISTRATION, AND MODIFICATION
ARTICLE 5: OBLIGATION AND PAYMENT*
ARTICLE 6: DISPUTES
ARTICLE 7: CONFIDENTIAL INFORMATION
ARTICLE 8: PUBLICATION AND ACADEMIC RIGHTS
ARTICLE 9: PATENT RIGHTS
ARTICLE 10: DATA RIGHTS
ARTICLE 11: SOFTWARE LICENSE
ARTICLE 12: FOREIGN ACCESS TO TECHNOLOGY*
ARTICLE 13: OPERATIONAL SECURITY*
ARTICLE 14: GOVERNING LAW AND JURISDICTION*
ARTICLE 15: TITLE AND DISPOSITION OF PROPERTY
ARTICLE 16: GOVERNMENT FURNISHED PROPERTY
ARTICLE 17: SAFEGUARDING COVERED DEFENSE INFORMATION AND CYBER INCIDENT REPORTING*
ARTICLE 18: STATUTORY AUTHORITY*
ARTICLE 19: INDEMNITY*
ARTICLE 20: ASSIGNMENT AND TRANSFER
ARTICLE 21: FORCE MAJEURE
ARTICLE 22: ORDER OF PRECEDENCE
ARTICLE 23: MISCELLANEOUS

ATTACHMENTS

ATTACHMENT 1: STATEMENT OF WORK
ATTACHMENT 2: WIDE AREA WORKFLOW INSTRUCTIONS

ATTACHMENT 3: AGREEMENT ADMINISTRATION
ATTACHMENT 4: DATA ASSERTIONS LIST
ATTACHMENT 5: COMPANY'S END USER LICENSE AGREEMENT ("EULA")
ATTACHMENT 6: AFFIRMATION OF BUSINESS STATUS CERTIFICATION
ATTACHMENT 7: PROHIBITION ON USE OF CERTAIN TELECOMMUNICATIONS AND VIDEO
SURVEILLANCE SERVICES OR EQUIPMENT

ARTICLE 1: DEFINITIONS

- 1.1. "Adequate security" means protective measures that are commensurate with the consequences and probability of loss, misuse, or unauthorized access to, or modification of information.
- 1.2. "Agreement" or "OTA" refers to the Other Transaction Agreement, as authorized under 10 U.S.C. 2371b, between the Government and COMPANY Agreement No. HQ0845-21-9-0031.
- 1.3. "Agreements Officer (AO)" is the Defense Innovation Unit Contracting Activity warranted Contracting Officer authorized to sign the final agreement for the Government.
- 1.4. "Agreements Officer's Representative (AOR)" is the individual designated by the Government on a per project basis to monitor all technical and administrative aspects.
- 1.5. "Commercial Computer Software" means software developed or regularly used for non-governmental purposes which -
- a. Has been sold, leased, or licensed to the public;
 - b. Has been offered for sale, lease, or license to the public;
 - c. Has not been offered, sold, leased, or licensed to the public but will be available for commercial sale, lease, or license in time to satisfy the delivery requirements of this agreement; or
 - d. Satisfies a criterion expressed in paragraphs a, b, or c of this definition and would require only minor modification to meet the requirements of this agreement.
- 1.6. "Commercial Computer Software License" means the license terms under which Commercial Computer Software is sold or offered for sale, lease or license to the general public.
- 1.7. "COMPANY attributional/proprietary information" means information that identifies the COMPANY(s), whether directly or indirectly, by the grouping of information that can be traced back to the COMPANY(s) (e.g., program description, facility locations), personally identifiable information, as well as trade secrets, commercial or financial information, or other commercially sensitive information that is not customarily shared outside of the company.
- 1.8. "Compromise" means disclosure of information to unauthorized persons, or a violation of the security policy of a system, in which unauthorized intentional or unintentional disclosure, modification, destruction, or loss of an object, or the copying of information to unauthorized media may have occurred.
- 1.9. "Computer Data Base" as used in this Agreement, means a collection of data recorded in a form capable of being processed by a computer. The term does not include computer software.
-

1.10. "Computer program" as used in this Agreement means a set of instructions, rules, or routines in a form that is capable of causing a computer to perform a specific operation or series of operations.

1.11. "Computer software" as used in this Agreement means computer programs, source code, source code listings, object code listings, design details, algorithms, processes, flow charts, formulae and related material that would enable the software to be reproduced, recreated or recompiled. Computer software does not include computer databases or computer software documentation.

1.12. "Computer software documentation" means owner's manuals, user's manuals, installation instructions, operating instructions, and other similar items, regardless of storage medium, that explain the capabilities of the computer software or provide instructions for using the software.

1.13. "Confidential Information" means information and materials of a Disclosing Party which are designated as confidential or as a Trade Secret in writing by such Disclosing Party, whether by letter or by use of an appropriate stamp or legend, prior to or at the same time any such information or materials are disclosed by such Disclosing Party to the Receiving Party. Notwithstanding the foregoing, materials and other information which are orally, visually, or electronically disclosed by a Disclosing Party, or are disclosed in writing without an appropriate letter, stamp, or legend, shall constitute Confidential Information or a Trade Secret if such Disclosing Party, within thirty calendar days after such disclosure, delivers to the Receiving Party a written document or documents describing the material or information and indicating that it is confidential or a Trade Secret, provided that any disclosure of information by the Receiving Party prior to receipt of such notice shall not constitute a breach by the Receiving Party of its obligations. "Confidential Information" includes any information and materials considered a Trade Secret by the COMPANY on its own behalf or on behalf of their subcontractors or suppliers.

1.14. "Contracting Activity" means an element of an agency designated by the agency head and delegated broad authority regarding acquisition functions. It also means elements or another agency designated by the director of a defense agency which has been delegated contracting authority through its agency charter.

1.15. "Controlled technical information" means technical information with military or space application that is subject to controls on the access, use, reproduction, modification, performance, display, release, disclosure, or dissemination. Controlled technical information would meet the criteria, if disseminated, for distribution statements B through F using the criteria set forth in DoD Instruction 5230.24, Distribution Statements on Technical Documents. The term does not include information that is lawfully publicly available without restrictions.

1.16. "Covered COMPANY information system" means an unclassified information system that is owned, or operated by or for, a COMPANY and that processes, stores, or transmits covered defense information.

1.17. "Covered defense information" means unclassified controlled technical information or other information, as described in the Controlled Unclassified Information (CUI) Registry at <http://www.archives.gov/cui/registry/category-list.html>, that requires safeguarding or dissemination controls pursuant to and consistent with law, regulations, and Government wide policies, and is—

- a. Marked or otherwise identified in the agreement, task order, or delivery order and provided to the COMPANY by or on behalf of DoD in support of the performance of the agreement; or
 - b. Collected, developed, received, transmitted, used, or stored by or on behalf of the COMPANY in support of the performance of the Agreement.
-

1.18. "Cyber incident" means actions taken through the use of computer networks that result in a compromise or an actual or potentially adverse effect on an information system and/or the information residing therein.

1.19. "Data" means recorded information, regardless of form or the media on which it may be recorded. The term includes technical data and computer software. The term does not include information incidental to agreement administration, such as financial, administrative, cost or pricing, or management information.

1.20. "Date of Completion" is the date on which all work is completed or the date on which the period of performance ends.

1.21. "Developed" means that an item, component, or process exists and is workable. Thus, the item or component must have been constructed or the process practiced. Workability is generally established when the item, component, or process has been analyzed or tested sufficiently to demonstrate to reasonable people skilled in the applicable art that there is a high probability that it will operate as intended. Whether, how much, and what type of analysis or testing is required to establish workability depends on the nature of the item, component, or process, and the state of the art. To be considered "developed," the item, component, or process need not be at the stage where it could be offered for sale or sold on the commercial market, nor must the item, component, or process be actually reduced to practice within the meaning of Title 35 of the United States Code.

1.22. "Development" means the systematic use of scientific and technical knowledge in the design, development, testing, or evaluation of a potential new product or service (or of an improvement in an existing product or service) to meet specific performance requirements or objectives. It includes the functions of design engineering, prototyping, and engineering testing.

1.23. "Disclosing Party" means COMPANY, or their subcontractors or suppliers, or the Government who discloses Confidential Information.

1.24. "Form, fit and function data" means technical data that describes the required overall physical, functional and performance characteristics (along with the qualification requirements, if applicable) of an item, component, or process to the extent necessary to permit identification of physically and functionally interchangeable items.

1.25. "Foreign Firm or Institution" means a firm or institution organized or existing under the laws of a country other than the United States, its territories, or possessions. The term includes, for purposes of this Agreement, any agency or instrumentality of a foreign government; and firms, institutions or business organizations which are owned or substantially controlled by foreign governments, firms, institutions, or individuals.

1.26. "Forensic analysis" means the practice of gathering, retaining, and analyzing computer-related data for investigative purposes in a manner that maintains the integrity of the data.

1.27. "Government" means the U.S. Government.

1.28. "Government Fiscal Year" means the period commencing on October 1 and ending September 30 of the following calendar year.

1.29. "Information system" means a discrete set of information resources organized for the collection, processing, maintenance, use, sharing, dissemination, or disposition of information.

1.30. "Know-How" means all information including, but not limited to discoveries, formulas, materials, inventions, processes, ideas, approaches, concepts, techniques, methods, software, programs, documentation, procedures, firmware, hardware, technical data, specifications, devices, apparatus and machines.

1.31. "Malicious software" means computer software or firmware intended to perform an unauthorized process that will have adverse impact on the confidentiality, integrity, or availability of an information system. This definition includes a virus, worm, Trojan horse, or other code-based entity that infects a host, as well as spyware and some forms of adware.

1.32. "Media" means physical devices or writing surfaces including, but is not limited to, magnetic tapes, optical disks, magnetic disks, large-scale integration memory chips, and printouts onto which covered defense information is recorded, stored, or printed within a covered COMPANY information system.

1.33. "Milestone" means a scheduled event signifying the completion of a major deliverable or a set of related deliverables as identified in the Statement of Work.

1.34. "Operationally critical support" means supplies or services designated by the Government as critical for airlift, sealift, intermodal transportation services, or logistical support that is essential to the mobilization, deployment, or sustainment of the Armed Forces in a contingency operation.

1.35. "Receiving Party" means COMPANY, or their subcontractors or suppliers, or the Government who receives Confidential Information disclosed by a Disclosing Party.

1.36. "Signatory Authority" refers to the individual that has the authority to legally bind a party to an agreement.

1.37. "Subject Invention" means any invention or discovery of the Government or Company, individually or jointly, that is conceived or first actually reduced to practice in the course of or under this agreement, and includes any art, method, process, machine, manufacture, design, or composition of matter, or any new and useful improvement thereof, whether patented or unpatented under the Patent Laws of the United States or any foreign country.

1.38. "Technical information" means technical data or computer software, examples of technical information include research and engineering data, engineering drawings, and associated lists, specifications, standards, process sheets, manuals, technical reports, technical orders, catalog-item identifications, data sets, studies and analyses and related information, and computer software executable code and source code.

1.39. "Trade Secret" means all forms and types of financial, business, scientific, technical, economic, or engineering or otherwise proprietary information, including, but not limited to, patterns, plans, compilations, program devices, formulas, designs, prototypes, methods, techniques, processes, procedures, programs, or codes, whether tangible or intangible, and whether or how stored, compiled, or memorialized physically, electronically, graphically, photographically, or in writing if:

- a. The owner thereof has taken reasonable measures to keep such information secret; and
 - b. The information derives independent economic value, actual or potential, from not being generally known to, and not being readily ascertainable through proper means by, the public.
-

1.40. "Technology" means discoveries, innovations, Know-How and inventions, whether patentable or not, including computer software, recognized under U.S. law as intellectual creations to which rights of ownership accrue, including, but not limited to, patents, trade secrets, mask works, and copyrights developed under this Agreement.

1.41. "Controlled Unclassified Information (CUI)" means unclassified information that requires safeguarding or dissemination controls, pursuant to and consistent with applicable law, regulations, and Government-wide policies. Instructions for the use, marking, dissemination, and storage of CUI can be found in DoD Instruction 5200.48, "Controlled Unclassified Information (CUI)."

ARTICLE 2: SCOPE OF THE AGREEMENT

2.1. Background

Other Transactions Agreement (OTA) is the term commonly used to refer to the 10 USC 2371b authority to enter into transactions other than contracts, grants or cooperative agreements. The Department of Defense (DoD) currently has authority to make awards that are directly relevant to enhancing the mission effectiveness of military personnel and the supporting platforms, systems, components, or materials proposed to be acquired or developed by the Department of Defense, or to improvement of platforms, systems, components, or materials in use by the armed forces. OTAs are acquisition instruments that are generally not subject to the Federal laws and regulations governing procurement (FAR based) contracts. As such, they are not required to comply with the Federal Acquisition Regulation (FAR), its supplements (e.g., DFARS) or laws that are limited in applicability to procurement contracts. This OTA is awarded in accordance with Commercial Solutions Opening (CSO) HQ0845-20-S-C001 procedures, posted Area of Interest, and is the result of a competitive process based on the COMPANY's submitted proposals.

2.2. Scope

2.2.1. This Agreement is an Other Transaction Agreement pursuant to 10 U.S.C. § 2371b. The principal purpose of this Agreement is to conduct a prototype project per Attachment 1: Statement of Work (SOW).

2.2.2. COMPANY shall be responsible for performance of the work set forth in the SOW. The COMPANY shall provide all documentation required in accordance with the deliverables table set forth in the SOW.

2.2.3. The COMPANY shall be paid a fixed amount for each milestone accomplished in accordance with the Schedule of Milestones and Payments set forth in Attachment 2: Wide Area Workflow Instructions and Article 5 procedures.

2.3. Potential for Follow-On Production

2.3.1. 10 U.S.C. Section § 2371b authorizes DoD to structure OT agreements with potential to award a follow-on, sole source production contract or transaction to the OT agreement participants. Two criteria must be met to use this authority; 1) competitive procedures were used to select the COMPANY and 2) the participants must have successfully completed the prototype project provided for in the transaction. This award leveraged competitive procedures outlined in accordance with the Area of Interest under the

solicitation vehicle represented in Article 2.1. This meets the first criterion needed to use the follow-on authority provided under title 10 U.S.C. § 2371b.

2.3.2. In accordance with 10 U.S.C. § 2371b the parties will consider this agreement or portions thereof successfully completed upon acceptance of specific: milestones, objectives, outcomes, or accomplishments as outlined in the SOW. In accordance with OSD policy, successful completion may occur prior to the completion of the entire prototype project. Additionally, completion can occur prior to the conclusion of a prototype project to allow the Government to transition any aspect of the prototype project determined to provide utility into production while other aspects of the prototype project have yet to be completed.

ARTICLE 3: TERM OF AGREEMENT AND TERMINATION

3.1. Term of this Agreement

The term of this agreement commences upon the effective date and continues as defined in the Statement of Work. Provisions of this Agreement, which, by their express terms or by necessary implication, apply for periods of time other than specified herein, shall be given effect, notwithstanding this Article.

3.2. Termination Provisions

The Government may terminate this Agreement by written notice to the COMPANY, provided that such written notice is preceded by consultation between the Parties. The COMPANY may request Agreement termination by giving the Government written notification with sufficient notice of their intent to do so. Failure of the Parties to agree to terminate shall be resolved pursuant to Article 6, Disputes.

3.3. Extending the Term

The Parties may extend, by mutual written agreement, the term of this Agreement if opportunities within the scope set forth in Article 2 reasonably warrant. Any extension shall be formalized through modification of the Agreement by the Agreements Officer and the COMPANY and in accordance with procedures outlined in Article 4.2.

3.4. Special Termination Clause

In the event the Government is made aware of an "outside investor" in violation of the Committee on Foreign Investment in the United States (CFIUS) or The Foreign Investment Risk Review Modernization Act of 2018 (FIRRMA), this Agreement will be subject to immediate termination without notification pursuant to Article 3.2. The COMPANY is encouraged to disclose outside investor activity in order for the Government to perform risk assessment of critical technology and national defense.

ARTICLE 4: MANAGEMENT, ADMINISTRATION, AND MODIFICATION

4.1. Administration. Unless otherwise provided in this Agreement, changes to this Agreement may only be made by the Agreements Officer. Administrative and contractual matters under this Agreement shall be referred to the representatives identified in Attachment 3: Agreement Administration.

4.2. Modifications

4.2.1. Recommendations for modifications, including justifications to support any changes to the SOW and terms of this agreement may originate with either a request from the COMPANY to the AOR and Agreements Officer, or the Government through the Agreements Officer. This documentation will detail the technical, chronological, and financial impact of the proposed modification to the program. The AO and the COMPANY shall approve any Agreement modification. The Government is not obligated to pay for additional or revised future milestones until the Milestone Payment chart in the SOW is formally revised and made part of this Agreement via a modification signed by the Agreements Officer.

4.2.2. The Agreements Officer is responsible for the review and approval of any recommendations to modify the SOW, or other proposed changes to the terms and conditions of this Agreement. If additional terms and conditions are required to be included to address work that may be required under this Agreement, they will be included by mutual written modification to this Agreement.

4.3.3. For minor or administrative Agreement modifications (e.g. changes in the paying office or appropriation data, changes to Government or the Company's personnel identified in the Agreement) no signature is required by the Company. Administrative modifications may be unilaterally executed by the Agreements Officer. All modifications except for administrative modifications shall be made by mutual written agreement of the parties.

4.3.4. The Agreements Officer is responsible for initiating all modifications to this Agreement.

ARTICLE 5: OBLIGATION AND PAYMENT

5.1. Obligation

This Agreement is funded in accordance with the amount annotated in the SF 26 Section G. In no case shall the Government's financial obligations exceed the amount obligated on the Agreement or by amendment to this Agreement. The Government is not obligated to reimburse the COMPANY for expenditures in excess of the amount of obligated funds allotted by the Government. If a modification becomes necessary in performance of this Agreement, pursuant to Article 4.2, the Agreements Officer and the COMPANY shall execute a revised Schedule of Milestones and Payments for prospective milestones.

5.2. Payments

5.2.1. The Parties agree that payments will be made in accordance with completion of milestones. These payments reflect value received by the Government toward the accomplishment of the prototype project goals of this Agreement.

5.2.2. The COMPANY shall document the accomplishments of each completed milestone by submitting or otherwise providing the Milestone Report required by the SOW. After verification (written or otherwise) of the accomplishment of the milestone by the AOR, the COMPANY will submit their invoice through Wide Area Workflow (WAWF), as detailed in Attachment 2.

5.2.3. Limitation of Funds: In no case shall the Government's financial liability exceed the amount obligated under this Agreement.

5.2.4. Payments will be made by the cognizant Defense Finance and Accounting Service office, as indicated in Attachment 2, within thirty (30) calendar days of an accepted invoice in WAWF. Attachment 2 details how to submit and process invoices through WAWF.

5.2.5. Payments shall be made in the amounts set forth in SF26 Section B, provided the AOR has verified the completion of the milestones.

5.2.6. The COMPANY shall maintain adequate records to account for all funding under this Agreement.

5.3. Financial Records and Reports:

5.3.1. The COMPANY shall maintain adequate records to account for Federal funds received under this Agreement and shall maintain adequate records to account for COMPANY Project Agreement funding provided under this Agreement. COMPANY relevant financial records are subject to examination or audit by or on behalf of the Comptroller General, DIU Contracting Activity, or other Government Official for a period not to exceed three years after expiration of the term of the Agreement. The Comptroller General, Agreements Officer or designee shall have direct access to sufficient records and information of any party to this agreement or any entity that participates in the performance of this agreement to ensure full accountability for all funding under this Agreement. Such audit, examination or access shall be performed during business hours on business days upon prior written notice and shall be subject to the security requirements of the audited party. Any audit required during the course of the program may be conducted by the Comptroller General or other Government Official using Government auditors or, at the request of COMPANY's external CPA accounting firm at the expense of the COMPANY. This requirement shall not apply with respect to a party or entity, or a subordinate element of a party or entity, that has not entered into any other agreement that provides for audit access by a Government entity in the year prior to the date of the agreement.

5.2.2. The COMPANY shall include this Article, suitably modified to identify the Parties, in all subcontracts or lower tier agreements entered into solely in connection with this Agreement.

ARTICLE 6: DISPUTES

6.1. General

The Parties shall communicate with one another in good faith and in a timely and cooperative manner when raising issues pertaining to this Agreement under this article, with the objective of resolving any misunderstanding, disagreement, claims, or disputes by mutual agreement.

6.2. Dispute Resolution Procedures

6.2.1. Any disagreement, claim or dispute between the Government and the COMPANY concerning questions of fact or law arising from or in connection with this Agreement, and, whether or not involving an alleged breach of this Agreement, may be raised only under this Article.

6.2.2. Whenever disputes, disagreements, or misunderstandings arise, the Parties shall attempt to resolve the issue(s) involved by discussion and mutual agreement as soon as practicable, with the goal of settlement within three (3) months of identification of the issue. Every reasonable attempt will be made to resolve all issues at the Agreements Officer's level. Alternative Dispute Resolution (ADR) procedures to include, but not limited to settlement negotiations, mediation and fact-finding, will be used to the maximum extent practicable. Whenever the COMPANY submits, in writing, a claim or issue to the Government, the Agreements Officer shall consider the claim or issue and, within 30 calendar days of receipt of the claim or issue in dispute, either:

- a. Prepare and transmit a written decision to the COMPANY, which shall include the basis for the decision, and accordingly document the Agreement file or;
- b. Notify the COMPANY of a specific date when the Agreements Officer will render a decision if more time is needed for response. The notice will inform the COMPANY of the reason for delaying the decision.

6.2.3. In the event the COMPANY decides to appeal the decision, the Agreements Officer shall make every effort to encourage the COMPANY to enter into ADR procedures with the Agreements Officer. The ADR procedure applicable to this Agreement expressed in subparagraphs below:

- a. Failing resolution by mutual agreement, the aggrieved Party shall document the dispute, disagreement, or misunderstanding by notifying the other Party through the cognizant Agreements Officer in writing documenting the relevant facts, identifying unresolved issues, specifying the clarification or remedy sought, and documenting the rationale as to why the clarification/remedy is appropriate. Within ten (10) working days after providing notice to the other Party, the aggrieved Party may, in writing, request a decision by the Senior Contracting Official, DIU. The other Party shall submit a written position on the matter(s) in dispute within thirty (30) calendar days after being notified that a decision has been requested. The Senior Contracting Official, DIU, will conduct a review of the matter(s) in dispute and render a decision in writing within thirty (30) calendar days of receipt of such position. Any such decision is final and binding, unless a Party shall, within thirty (30) calendar days request further review as provided by this article. If requested within thirty (30) calendar days of the decision by the Senior Contracting Official, DIU, further review will be conducted by the President of the COMPANY and the DIU Director. In the event of a decision, or in absence of a decision within sixty (60) calendar days of referral to the President of the COMPANY and the DIU Director (or such other period as agreed to by the parties), either party may pursue any right or remedy provided by law. Alternatively, the parties may agree to explore and establish an Alternate Disputes Resolution procedure to resolve this dispute.

- b. If the COMPANY chooses not to participate in the Dispute Resolution Procedure or does not accept the results of the Dispute Resolution Procedure, the COMPANY may bring a formal claim as authorized by 28 U.S.C. 1491 or other applicable statutes, and pursue any right and remedy in a court of competent jurisdiction. The Parties' attempt to resolve issues through settlement negotiations, mediation and fact-finding pursuant to this Article 6 shall be non-binding and without prejudice to either Party.

6.3. Limitation of Damages

Claims for damages of any nature whatsoever pursued under this Agreement shall be limited to direct damages only up to the aggregate amount of Government funding disbursed as of the time the dispute arises. In no event shall the Government be liable for claims for consequential, punitive, special and incidental damages, claims for lost profits, or other indirect damages.

ARTICLE 7: CONFIDENTIAL INFORMATION

7.1. Exchange of Information

The Government may from time to time disclose Government Confidential Information to the COMPANY and its subcontractors or suppliers, in connection with a particular project, and the COMPANY and its subcontractors or suppliers, may from time to time disclose information that is Trade Secret or Confidential Information to the Government in connection with the OTA or performance thereunder. Neither the

Government nor COMPANY or their subcontractors or suppliers shall be obligated to transfer Confidential Information or Trade Secrets independently developed by the Government or the COMPANY or their subcontractors or suppliers, absent an express written agreement between the Parties providing the terms and conditions for such disclosure.

7.2. Confidentiality and Authorized Disclosure

The Receiving Party agrees, to the extent permitted by law, that Confidential Information and Trade Secrets shall remain the property of the Disclosing Party (no one shall disclose unless they have the right to do so), and that, unless otherwise agreed to by the Disclosing Party, Confidential Information and Trade Secrets shall not be disclosed, divulged, or otherwise communicated by it to third parties or used by it for any purposes other than in connection with specified project efforts and the licenses granted in Article 8, Article 9, and Article 10, provided that the duty to protect such "Confidential Information" and "Trade Secrets" shall not extend to materials or information that:

1. Are received or become available without restriction to the Receiving Party under a proper, separate agreement,
2. Are not identified with a suitable notice or legend per Article entitled "Confidential Information" herein,
3. Are lawfully in possession of the Receiving Party without such restriction to the Receiving Party at the time of disclosure thereof as demonstrated by prior written records,
4. Are or later become part of the public domain through no fault of the Receiving Party,
5. Are received by the Receiving Party from a third party having no obligation of confidentiality to the Disclosing Party that made the disclosure,
6. Are developed independently by the Receiving Party without use of Confidential Information or Trade Secrets as evidenced by written records,
7. Are required by law or regulation to be disclosed; provided, however, that the Receiving Party has provided written notice to the Disclosing Party promptly so as to enable such Disclosing Party to seek a protective order or otherwise prevent disclosure of such information.

7.3. Return of Proprietary Information

Upon the request of COMPANY, the Government shall promptly return all copies and other tangible manifestations of the Confidential Information or Trade Secrets disclosed. Upon request by the Government, COMPANY shall promptly return all copies and other tangible manifestations of the Confidential Information disclosed by the Government. As used in this section, tangible manifestations include human readable media as well as magnetic and digital storage media.

7.4. Term

Except to the extent covered by and subject to other provisions of this Agreement, the obligations of the Receiving Party under this Article shall continue for a period of five (5) years after the expiration or termination of this Agreement.

7.5. Subcontracts

The Government and the COMPANY shall flow down the requirements of this Article to their respective personnel, agents, partners, and team members receiving such Confidential Information or Trade Secrets under this OTA.

ARTICLE 8: PUBLICATION AND ACADEMIC RIGHTS

8.1. Use of Information

Subject to the provisions of Article 7, Confidential Information, and this Article, Publication and Academic Rights, the COMPANY and the Government shall have the right to publish or otherwise disclose information and/or data developed by the Government and/or the respective COMPANY under this Agreement. The COMPANY and the Government (and its employees) shall include an appropriate acknowledgement of the sponsorship of the Research Projects by the Government and the COMPANY in such publication or disclosure. The Parties shall have only the right to use, disclose, and exploit any such data and Confidential Information or Trade Secrets in accordance with the rights held by them pursuant to this Agreement. Notwithstanding the above, the Parties shall not be deemed authorized by Article 8.1, alone, to disclose any Confidential Information or Trade Secrets of the Government or the COMPANY. Nothing contained herein shall contradict or contravene any use of unlimited data rights obtained under Article 10 below.

8.2. Classified Research Projects

If a release of Confidential Information or Trade Secrets is for a classified Research Project, the provisions of the DoD Security Agreement (DD Form 441), Certificate Pertaining to Foreign Interests (SF 328), and the DoD Contract Security Classification Specification (DD Form 254) apply. The Government will be responsible for the completion of the DD Form 254. The COMPANY member must complete the DD Form 441 and SF 328 and provide them to the Government through for review by the proper Government representatives, the Industrial Security Representative at the cognizant Defense Security Service (DSS) office for DD Form 441 and SF 328 and the requiring activity's local Security office for the DD Form 254.

8.3. Review or Approval of Technical Information for Public Release

8.3.1. At least 30 days prior to the scheduled release date, COMPANY shall submit to the Agreements Officer two copies of the information to be released. The Agreements Officer will route the information to the AOR and other appropriate parties for review and approval.

8.3.2. The AOR is hereby designated as the approval authority for the Agreements Officer for such releases.

8.3.3. Parties to this Agreement are responsible for ensuring that an acknowledgment of government support will appear in any publication of any material based on or developed under this OTA, using the following acknowledgement terms:

"Effort sponsored by the U.S. Government under Other Transaction number HQ0845-21-9-0031 between the COMPANY and the Government. The U.S. Government is authorized to reproduce and distribute reprints for Governmental purposes notwithstanding any copyright notation thereon."

8.3.4. Parties to this Agreement are also responsible for assuring that every publication of material based on or developed under this project contains the following disclaimer:

“The views and conclusions contained herein are those of the authors and should not be interpreted as necessarily representing the official policies or endorsements, either expressed or implied, of the U.S. Government.”

8.3.5. The COMPANY shall flow down these requirements to its partners and team members, at all tiers.

8.4. Filing of Patent Applications

During the course of any such thirty (30) calendar day period, the COMPANY and/or the Government shall provide notice to the Agreements Officer as to whether it desires that a patent application be filed on any invention disclosed in such materials. In the event that a COMPANY and/or the Government desires that such a patent be filed, the COMPANY or the Government proposing to publish or disclose such materials agrees to withhold publication and disclosure of such materials until the occurrence of the first of the following:

1. Filing of a patent application covering such invention, or
2. Written agreement, from the Agreements Officer and the COMPANY that no patentable invention is disclosed in such materials.
3. Further, during the course of any such thirty (30) calendar day period, the COMPANY shall notify the Agreements Officer and the Government if it believes any of its Confidential Information or Trade Secrets have been included in the proposed publication or disclosure and shall identify the specific Confidential Information or Trade Secrets that need to be removed from such proposed publication. The Government and the COMPANY agree to remove from the proposed publication or disclosure all such Confidential Information or Trade Secrets so identified by the COMPANY.

ARTICLE 9: PATENT RIGHTS

9.1. Allocation of Principal Rights

9.1.1. Unless the COMPANY notifies the Government, in accordance with subparagraph 2 below, that the COMPANY does not intend to retain title, the COMPANY shall retain the entire right, title, and interest throughout the world to each Subject Invention consistent with the provisions of this Article.

9.1.2. With respect to any Subject Invention in which the COMPANY retains title, the Government shall receive a nonexclusive, nontransferable, irrevocable, paid-up license to practice, or to have practiced (make, have made, use, have used, or import) the Subject Invention throughout the world on behalf of the United States for U.S. Government purposes and on behalf of any foreign government or international organization pursuant to any existing or future treaty or agreement with the United States in accordance with 35 U.S.C. § 209(d)(1) and 37 C.F.R. 404.7(a)(2)(i). The COMPANY shall record a confirmatory instrument of the Government's license to the Subject Invention with the United States Patent and Trademark Office.

9.1.3. In accordance with 37 C.F.R. 404.7(a)(2)(ii), the Government retains the right to grant licenses to third parties on reasonable terms when necessary to fulfill health, safety, or other needs of the public to the extent such needs are not being reasonably satisfied by COMPANY.

9.2. EULA Considerations

All Data delivered to the Government under this Agreement, other than Data Developed or Generated under this Agreement, shall be subject to the restrictions and limitations set forth in COMPANY's End User License Agreement ("EULA") at Attachment 5 (if applicable) provided they are consistent with federal law. To the extent the terms and conditions in the COMPANY's EULA, including all subcontractor EULAs, are inconsistent with federal law, they shall be deemed deleted and unenforceable including, but not limited to the following:

1. Any future changes to this Agreement or the EULA must be signed by a duly warranted Agreements Officer, in writing. The same requirement applies to contract modifications affecting the rights of the parties. All terms and conditions intended to bind the Government must be included within the contract signed by a warranted Agreements Officer.
2. Clauses in the EULA referencing termination or cancellation are hereby deemed to be deleted. Termination and cancellations will be governed by Article 3 of this Agreement.
3. Any disputes relating to the EULA shall be resolved in accordance with Article 6 of this Agreement. Any provisions of the EULA that would subject the United States to any law, jurisdiction, or venue other than that of the United States is hereby deemed to be deleted. The validity, interpretation and enforcement of this Agreement and the attached EULA will be governed by and construed in accordance with federal law as opposed to any state or local law.
4. All EULA clauses referencing Licensee Indemnities are hereby deemed to be deleted. All EULA clauses that (1) violate the Department of Justice's right to represent the Government in any case (28 U.S.C. § 516) and/or (2) require that the Government give sole control over the litigation and/or settlement, are hereby deemed to be deleted.
5. All EULA clauses that violate the Anti-Deficiency Act (31 U.S.C. § 1341), which prohibits the Government from paying any fees or penalties beyond the Agreement amount (including attorney's and expert witness fees), unless specifically authorized by existing statutes, are hereby deemed to be deleted. This includes, but is not limited to, provisions indicating paid services, fees, charges, and/or billing practices will renew automatically until the licensee elects to cancel.
6. COMPANY's warranty clause shall not impair the U.S. Government's right to recover for fraud or crimes arising out of or related to this Agreement under any federal fraud statute, including, but not limited, to the False Claims Act, 31 U.S.C. §§ 3729-3733.
7. The EULA does not represent the entire agreement, but will be incorporated as an attachment and made a material part of the Agreement.

9.3. Marking of Data

Pursuant to Article 9.1 and Article 1 any Data delivered under this Agreement, except for Data subject to COMPANY's EULA pursuant to Article 9.2, above, shall be marked with the appropriate data rights markings and the COMPANY's name and address and include the following legend:

"Use, duplication, or disclosure is subject to the restrictions as stated in Agreement HQ0845-21-9-0031 between the Government and the COMPANY."

9.4. Lower Tier Agreements

The COMPANY shall include this Article, suitably modified to identify the Parties, in all subcontracts or lower tier agreements entered into solely in connection with this Agreement.

ARTICLE 10: DATA RIGHTS

10.1. Allocation of Principal Rights

10.1.1. Data that will be delivered, furnished, or otherwise provided to the Government under this Agreement, in which the Government has previously obtained rights, shall be delivered, furnished, or provided with the pre-existing rights, unless (a) the parties have agreed otherwise, or (b) any restrictions on the Government's rights to use, modify, reproduce, release, perform, display, or disclose the data have expired or no longer apply.

10.1.2. Identification of Principal Rights: See Attachment 4.

10.1.3. Marking of Data: Any Data delivered under this Agreement shall be marked with the following legend:

"This data is being delivered as Commercial Computer Software or Technical Data, as defined in Agreement HQ0845-21-9-0031. Use, duplication, or disclosure is subject to the restrictions as stated in Agreement HQ0845-21-9-0031 between the COMPANY and the Government."

10.1.4. In the event that the COMPANY learns of a release to the Government of its unmarked Data that should have contained a restricted legend, the COMPANY will have the opportunity to cure such omission going forward by providing written notice to the Agreements Officer within six (6) months of the erroneous release.

10.2. Prior Technology

In the event it is necessary for the COMPANY to furnish the Government with Data which existed prior to, or was produced outside of this Agreement, and such Data embodies trade secrets or comprises commercial or financial information which is privileged or confidential, and such Data is so identified with a suitable notice or legend, the Data will be maintained in confidence and disclosed and used by the Government and such Government Contractors or contract employees that the Government may hire on a temporary or periodic basis only for the purpose of carrying out the Government's responsibilities under this Agreement. Data protection will include proprietary markings and handling, and the signing of nondisclosure agreements by such Government Contractors or contract employees. The COMPANY shall not be obligated to provide Data that existed prior to, or was developed outside of this Agreement to the Government. Upon completion of activities under this Agreement, such Data will be disposed of as requested by the COMPANY.

10.3. Oral and Visual Information

If information which the COMPANY considers to embody trade secrets or to comprise commercial or financial information which is privileged or confidential is expressly disclosed orally or visually directly to the Government, the exchange of such information must be memorialized in tangible, recorded form and marked with a suitable notice or legend, and furnished to the Government within thirty (30) calendar days after such oral or visual disclosure, or the Government shall have no duty to limit or restrict, and shall not incur any liability for any disclosure and use of such information. If the Government reasonably

determines that the memorialization of the exchange is insufficiently detailed to enable it to identify the privileged or confidential information, COMPANY shall provide additional detail at the Government's request, subject to restrictions on use and disclosure.

10.4. Disclaimer of Liability

10.4.1. Notwithstanding the above, the Government shall not be restricted in, nor incur any liability for, the disclosure and use of:

- a. Data not identified with a suitable notice or legend as set forth in this Article; nor
- b. Information contained in any Data for which disclosure and use is restricted, if such information is or becomes generally known without breach of the above, is properly known to the Government or is generated by the Government independent of carrying out responsibilities under this Agreement, is rightfully received from a third party without restriction, or is included in Data which the COMPANY has furnished, or is required to furnish to the Government without restriction on disclosure and use.

10.4.2. Notwithstanding Article 10.4.1.a., if the COMPANY cures the omission of the suitable notice or legend, the restrictions, and related liability for disclosure and use of such information shall apply after cure unless it is then unrestricted under Article 10.4.1.b.

10.5. Copyright

The COMPANY hereby grants to the U.S. Government a non-exclusive, non-transferable, royalty-free, fully paid-up license to reproduce, prepare derivative works, distribute copies to the public, and perform publicly and display publicly any copyrighted materials developed (excluding Data) under this Agreement to which it owns the copyright, and to authorize others to do so.

10.6. Lower Tier Agreements

The COMPANY shall include this Article, suitably modified to identify the parties, in all, subcontracts or lower tier agreements, regardless of tier, or experimental, developmental, or research work.

10.7. Survival Rights

Provisions of this Article shall survive termination of this Agreement.

ARTICLE 11: SOFTWARE LICENSE

11.1. License and Restrictions

11.1.1. Subject to the terms and conditions of this Agreement, the COMPANY grants to the Government, a non-sublicensable, nonexclusive license (the "License") to the Products set forth in this OTA during the term of the License Term in each Order placed under this Agreement. The Government may allow access to the Products to Government Authorized Users. Under the License, the COMPANY grants the

Government the right to permit Government Authorized Users to access the Products and where applicable, Reports, through the applicable interfaces.

11.1.2. License to Documentation. Subject to Article 7 (Confidential Information) and Article 10 (Data Rights), the Government may make and distribute copies of the Documentation for use solely by Government Authorized Users in connection with use of the Products in accordance with this Agreement, but no more than the amount reasonably necessary. Any permitted copy of the Documentation must contain the same copyright and other proprietary notices that appear in the Documentation.

11.1.3. License Restrictions. Except for the rights expressly granted under this Agreement, the Government shall not:

- a. use the Products in (A) violation of any applicable law (including, where applicable, Children's Online Privacy Protection Act (COPPA)), or in connection with unlawful material (such as material that violates any obscenity, defamation, harassment, privacy, or intellectual property laws); or (B) a manner that would cause a material risk to the security or operations of COMPANY or any of its customers, or to the continued normal operation of other COMPANY customers;
- b. republish, display, sell, rent, lease, host, circulate, disseminate, assign or sub-license the Products;
- c. offer, use, or permit the use of the Products in a computer service business, third-party outsourcing service, on a membership or subscription basis, on a service bureau basis, on a time-sharing basis, as part of a hosted service, or on behalf of any third party;
- d. attempt to interact with the operating system underlying the Products, or modify, create derivative works of, adapt, translate, reverse engineer, decompile, or otherwise attempt to discover the source code in, any COMPANY technical data. This restriction will not apply to the extent it limits any non-waivable right Government may enjoy under applicable law;
- e. remove, obscure, or alter any proprietary notices associated with the Products (including any notices in reports that are deliverables under this Agreement);
- f. use any software components, modules, or other services that may be delivered with the Products, but which are not licensed to Government; or
- g. unbundle any components of the Products for use on different computers or devices as the Products are designed and provided to Government for use as single non-severable offerings. The COMPANY reserves all other rights not expressly granted in this Agreement.

11.2. Security and Support

The COMPANY shall:

1. not use, modify or disclose to anyone any electronic data or information submitted by the Government to or through the Products or specific identifiable information on the Government's use of the Products ("Government Data"), except as reasonably required to provide the Products to the Government;
 2. provide the Government with support for the Products in accordance with the COMPANY's then-current standard support policies and all support requirements required under this OTA. The COMPANY may from time to time at its sole discretion modify, update, upgrade or extend the Products
-

(including, without limitation, for the purposes of adding features and functionality, or enhancing security or usability).

11.3. Third Party Access

11.3.1. Subject to Article 7 (Confidential Information) and Article 10 (Data Rights) above, the Government may allow a third-party covered Government support contractor to operate, use or access the data/Products solely on Government's behalf. The COMPANY may require the Government support contractor to enter into a non-disclosure agreement directly with the COMPANY regarding the Government support contractor's operation, use or access of such data/Products, or alternatively, that the COMPANY (or party asserting restrictions) may waive in writing the requirement for a nondisclosure agreement.

11.3.1.1 Anticipated Government support contractors assisting in this effort are identified below:



11.3.2. COMPANY Responsibility. Submission of a proposal under this RPP will constitute a grant of authority by the COMPANY to the Government to allow the use of Government support contractors to operate, use or access the data/Products solely on Government's behalf, and such use or access shall be subject to the terms of this Agreement. If the COMPANY determines the need to enter into a non-disclosure agreement directly with the Government support contractor, the COMPANY shall notify the Agreements Officer, DIU PM and AOR in writing.

11.4. Limited Warranty

Limited Warranty and Remedy for Software. COMPANY warrants that the Software, as delivered to Government, will substantially perform as stated. The Government will notify COMPANY of a claim under this warranty within 30 days of the date on which the condition giving rise to the claim first appeared. To the extent permitted by law, Government's sole and exclusive remedy and COMPANY's sole liability under or in connection with this warranty will be a replacement of the Distributed Code (as applicable), or if replacement is not commercially reasonable, a termination of the applicable Software and a refund of any pre-paid unused fees for the applicable Software.

ARTICLE 12: FOREIGN ACCESS TO TECHNOLOGY

This Article shall remain in effect during the term of the Agreement and for five (5) years thereafter.

12.1. General

The Parties agree that research findings and technology developments arising under this Agreement may constitute a significant enhancement to the national defense, and to the economic vitality of the United States. Accordingly, access to important technology developments under this Agreement by Foreign Firms or Institutions must be carefully controlled. The controls contemplated in this Article are in addition to, and are not intended to change or supersede, the provisions of the International Traffic in Arms Regulations (22 C.F.R. Part 120, et seq.), the National Industrial Security Program Operating Manual (NISPOM) (DoD

5220.22-M), and the Department of Commerce's Export Administration Regulations (15 C.F.R. Part 730, et seq.).

12.2. Restrictions on Sale or Transfer of Technology to Foreign Firms or Institutions

12.2.1. In order to promote the national security interests of the United States and to effectuate the policies that underlie the regulations cited above, the procedures stated in Article 12.2.2, 12.2.3, and 12.2.4 below shall apply to any transfer of Technology. For purposes of this paragraph, a transfer includes a sale of the company, or sales or licensing of Technology. Transfers include:

- a. Sales of products or components; or
- b. Licenses of the software or documentation related to sales of products or components; or
- c. Transfer to foreign subsidiaries of the COMPANY for purposes related to this Agreement; or
- d. Transfer which provides access to Technology to a Foreign Firm or Institution which is an approved source of supply or source for the conduct of research under this Agreement provided that such transfer shall be limited to that necessary to allow the firm or institution to perform its approved role under this Agreement.

12.2.2. The COMPANY shall provide timely notice to the Government of any proposed transfers from the COMPANY of Technology developed under this Agreement to Foreign Firms or Institutions. If the Government determines that the transfer may have adverse consequences to the national security interests of the United States, the COMPANY, its vendors, and the Government shall jointly endeavor to find alternatives to the proposed transfer which obviate or mitigate potential adverse consequences of the transfer but which provide substantially equivalent benefits to the COMPANY.

12.2.3. In any event, the COMPANY shall provide written notice to the Agreements Officer of any proposed transfer to a foreign firm or institution at least sixty (60) calendar days prior to the proposed date of transfer. Such notice shall cite this Article and shall state specifically what is to be transferred and the general terms of the transfer. Within thirty (30) calendar days of receipt of the COMPANY's written notification, the Agreements Officer shall advise the COMPANY whether it consents to the proposed transfer. In cases where the Government does not concur or sixty (60) calendar days after receipt and the Government provides no decision, the COMPANY may utilize the procedures under Article V, Disputes. No transfer shall take place until a decision is rendered.

12.2.4. In the event a transfer of Technology to Foreign firms or Institutions which is NOT approved by the Government takes place, the COMPANY shall (a) refund to the Government funds paid for the development of the Technology and (b) the Government shall have a non-exclusive, nontransferable, irrevocable, paid-up license to practice, or to have practiced on behalf of the United States the Technology throughout the world for Government and any and all other purposes, particularly to effectuate the intent of this Agreement. Upon request of the Government, the COMPANY shall provide written confirmation of such licenses.

12.3. Export Compliance

Each Party agrees to comply with U.S. Export regulations including, but not limited to, the requirements of the Arms Export Control Act, 22 U.S.C. § § 2751-2794, including the International Traffic in Arms Regulation (ITAR), 22 C.F.R. § 120 et seq.; and the Export Administration Act, 50 U.S.C. app. § 2401-2420. Each party is responsible for obtaining from the Government export licenses or other authorizations/approvals, if required, for information or materials provided from one party to another under

this Agreement. Accordingly, the COMPANY shall not export, directly, or indirectly, any products and/or technology, Confidential Information, Trade Secrets, or Classified and Unclassified Technical Data in violation of any U.S. Export laws or regulations.

12.4. Lower Tier Agreements

The COMPANY shall include this Article, suitably modified, to identify the Parties, in all subcontracts or lower tier agreements, regardless of tier, for experimental, developmental, or research work.

ARTICLE 13: OPERATIONAL SECURITY

Access and General Protection/Security Policy and Procedures. All COMPANY employees, including subcontractor employees, shall comply with all installation and facility access and local security policies and procedures (provided by Government representative), and security/emergency management exercises. The COMPANY shall also provide all information required for background checks to meet installation access requirements. The COMPANY workforce shall comply with all personal identity verification and accountability requirements as directed by DoD, the Government customer and/or local policy. Should the Force Protection Condition (FPCON) at any individual facility or installation change, the Government may require changes in COMPANY security matters or processes. During FPCONs Charlie and Delta, services/installation access may be discontinued/postponed due to higher threat. Services will resume when FPCON level and/or threat is reduced to an acceptable level as determined by the Installation Commander. The COMPANY shall be subject to and comply with vehicle searches, wearing of ID badges, etc. If access to classified information becomes required in the performance of this Agreement such access will be in accordance with the DoD 5220.22-M, National Industrial Security Program Operating Manual (NISPOM), and all applicable DoD personnel security regulations.

ARTICLE 14: GOVERNING LAW AND JURISDICTION

This Agreement shall be construed and enforced in accordance with the laws of the United States in a Federal Court with competent jurisdiction. Any dispute arising under this Agreement shall first be handled in accordance with Article 5: Disputes of this Agreement.

ARTICLE 15: TITLE TO AND DISPOSITION OF PROPERTY

Company is required to obtain Agreement Officer written approval for any acquired property valued at \$5,000 or more under this Agreement. The Government will not take title to Company acquired or produced property, except property the agreement identifies as deliverable property, unless the parties agree otherwise. Title to all other property shall remain with the COMPANY. The COMPANY shall be responsible for the maintenance, repair, protection, and preservation of all such property at its own expense.

ARTICLE 16: GOVERNMENT FURNISHED PROPERTY

The Government will provide the COMPANY with the Government Furnished Property (GFP) listed in the Statement of Work (SOW) and/or referenced in a Government Furnished Property List that may be incorporated as an attachment to this Agreement to facilitate the performance of this OTA.

The COMPANY shall assume the risk of and be responsible for any loss or destruction of, or damage to, the GFP while it is in the COMPANY's possession or control, with the exception of reasonable wear and tear or reasonable and proper consumption. The GFP shall be returned at the end of the OTA Period of Performance in a condition that is as good as when it was received with the exception of said reasonable wear and tear, or in accordance with the provisions of the OTA regarding its use. The COMPANY shall obtain explicit written authorization for any transfer or disposition of the GFP.

ARTICLE 17: SAFEGUARDING COVERED DEFENSE INFORMATION AND CYBER INCIDENT REPORTING

17.1. Adequate Security. The COMPANY shall provide adequate security on all covered COMPANY information systems. To provide adequate security, the COMPANY shall implement, at a minimum, the following information security protections:

17.1.1. For covered COMPANY information systems that are part of an Information Technology (IT) service or system operated on behalf of the Government, the following security requirements apply:

a. Cloud computing services shall be subject to the security requirements specified:

(1) The COMPANY shall implement and maintain administrative, technical, and physical safeguards and controls with the security level and services required in accordance with the Cloud Computing Security Requirements Guide (SRG) found at http://iase.disa.mil/cloud_security/Pages/index.aspx, unless notified by the Agreements Officer Representative that this requirement has been waived by the DoD Chief Information Officer.

(2) The COMPANY shall maintain within the United States or outlying areas all Government data that is not physically located on Government premises, unless the COMPANY receives written notification from the Agreements Officer Representative to use another location.

b. Any other such IT service or system (i.e., other than cloud computing) shall be subject to the security requirements specified elsewhere in this contract.

17.1.2. For 'covered COMPANY information systems' that are not part of an IT service or system operated on behalf of the Government and therefore are not subject to the security requirement specified at Article 17.1.1., the following security requirements apply:

a. Except as provided in Article 17.1.1.b, the covered COMPANY information system shall be subject to the security requirements in National Institute of Standards and Technology (NIST) Special Publication (SP) 800-171, "Protecting Controlled Unclassified Information in Nonfederal Information Systems and Organizations" (available via the internet at <http://dx.doi.org/10.6028/NIST.SP.800-171>) in effect at the time the solicitation is issued or as authorized by the Contracting Officer.

b. The National Institute of Standards and Technology Considerations:

(1) The COMPANY shall implement NIST SP 800-171, as soon as practical.

(2) The COMPANY shall submit requests to vary from NIST SP 800-171 in writing to the Agreements Officer, for consideration by the DoD CIO. The COMPANY need not implement any security requirement adjudicated by an authorized representative of the DoD CIO to be non-applicable or to have an alternative, but equally effective, security measures that may be implemented in its place.

(3) If the DoD CIO has previously adjudicated the COMPANY's requests indicating that a requirement is not applicable or that an alternative security measure is equally effective, a copy of that approval shall be provided to the Agreements Officer or Agreements Officer Representative when requesting its recognition under this agreement.

(4) If the COMPANY intends to use an external cloud service provider to store, process, or transmit any covered defense information in performance of this contract, the COMPANY shall require and ensure that the cloud service provider meets security requirements equivalent to those established by the Government for the Federal Risk and Authorization Management Program (FedRAMP) Moderate baseline (<https://www.fedramp.gov/resources/documents/>) and that the cloud service provider complies with requirements in Article 17.2 to 17.6 for cyber incident reporting, malicious software, media preservation and protection, access to additional information and equipment necessary for forensic analysis, and cyber incident damage assessment.

17.1.3. Apply other information systems security measures when the COMPANY reasonably determines that information systems security measures, in addition to those identified in Article 17.1.2.b(1) and Article 17.1.2.b(2), may be required to provide adequate security in a dynamic environment or to accommodate special circumstances (e.g., medical devices) and any individual, isolated, or temporary deficiencies based on an assessed risk or vulnerability. These measures may be addressed in a system security plan.

17.2. Cyber Incident Reporting Requirement

17.2.1. When the COMPANY discovers a cyber incident that affects a covered COMPANY information system or the covered defense information residing therein, or that affects the COMPANY's ability to perform the requirements of the contract that are designated as operationally critical support and identified in the agreement, the COMPANY shall—

a. Conduct a review for evidence of compromise of covered defense information, including, but not limited to, identifying compromised computers, servers, specific data, and user accounts. This review shall also include analyzing covered COMPANY information system(s) that were part of the cyber incident, as well as other information systems on the COMPANY's network(s), that may have been accessed as a result of the incident in order to identify compromised covered defense information, or that affect the COMPANY's ability to provide operationally critical support; and

b. Rapidly report any cyber incident(s) within 72 hours of discovery to DoD at <http://dibnet.dod.mil>

17.2.2. Cyber incident report. The cyber incident report shall be treated as information created by or for DoD and shall include, at a minimum, the required elements at <http://dibnet.dod.mil>.

17.2.3. Medium assurance certificate requirement. In order to report cyber incidents in accordance with this clause, the COMPANY or subcontractor shall have or acquire a DoD-approved medium assurance certificate to report cyber incidents. For information on obtaining a DoD-approved medium assurance certificate, see <http://iase.disa.mil/pki/cca/Pages/index.aspx>.

17.3. Malicious software. When the COMPANY or subcontractors discover and isolate malicious software in connection with a reported cyber incident, submit the malicious software to DoD Cyber Crime Center (DC3) at this website: <https://www.dc3.mil/> or in accordance with additional instructions provided by DC3 or the Agreements Officer or the Agreements Officer Representative. Do not send the malicious software to the Agreements Officer or Agreements Officer Representative.

17.4. Media preservation and protection. When a COMPANY discovers a cyber incident has occurred, the COMPANY shall preserve and protect images of all known affected information systems identified in Article 17.2.1.a and all relevant monitoring/packet capture data for at least 90 days from the submission of the cyber incident report to allow DoD to request the media or decline interest.

17.5. Access to additional information or equipment necessary for forensic analysis. Upon request by DoD, the COMPANY shall provide DoD with access to additional information or equipment that is necessary to conduct a forensic analysis.

17.6. Cyber incident damage assessment activities. If DoD elects to conduct a damage assessment, the AO will request that the COMPANY provide all of the damage assessment information gathered in accordance with Article 17.4.

17.7. DoD safeguarding and use of COMPANY attributional/proprietary information. The Government shall protect against the unauthorized use or release of information obtained from the COMPANY (or derived from information obtained from the COMPANY) under this clause that includes COMPANY attributional/proprietary information, including such information submitted in accordance with Article 17.2. To the maximum extent practicable, the COMPANY shall identify and mark attributional/proprietary information. In making an authorized release of such information, the Government will implement appropriate procedures to minimize the COMPANY attributional/proprietary information that is included in such authorized release, seeking to include only that information that is necessary for the authorized purpose(s) for which the information is being released.

17.8. Use and release of COMPANY attributional/proprietary information not created by or for DoD

Information that is obtained from the COMPANY (or derived from information obtained from the COMPANY) under this clause that is not created by or for the Government is authorized to be released outside of Government-

1. To entities with missions that may be affected by such information;
2. To entities that may be called upon to assist in the diagnosis, detection, or mitigation of cyber incidents;
3. To Government entities that conduct counterintelligence or law enforcement investigations;
4. For national security purposes, including cyber situational awareness and defense purposes (including with Defense Industrial Base (DIB) participants in the program at 32 CFR part 236).

17.9. Use and release of COMPANY attributional/proprietary information created by or for DoD

Information that is obtained from the COMPANY (or derived from information obtained from the COMPANY) under this Article that is created by or for the Government (including the information submitted pursuant to Article 17.2) is authorized to be used and released outside of the Government for purposes and activities authorized by Article 17.8 , and for any other lawful Government purpose or

activity, subject to all applicable statutory, regulatory, and policy based restrictions on the Government's use and release of such information.

17.10. Other safeguarding or reporting requirements. The safeguarding and cyber incident reporting required by this clause in no way abrogates the COMPANY's responsibility for other safeguarding or cyber incident reporting pertaining to its unclassified information systems as required by other applicable clauses of this contract, or as a result of other applicable U.S. Government statutory or regulatory requirements.

17.11. Lower Tier Agreements. The COMPANY shall include this Article, suitably modified to identify the Parties, in all subcontracts or lower tier agreements entered into solely in connection with this Agreement.

ARTICLE 18: STATUTORY AUTHORITY

This Agreement is not a Federal procurement contract, grant or cooperative agreement. Nothing in this Agreement or its attachments will be construed as incorporating by reference or implication any provision of Federal acquisition law or regulation not specifically mentioned in this Agreement. This Agreement is subject to the compliance requirements of Title VI of the Civil Rights Act of 1964 as amended (42 U.S.C. § 2000d) relating to nondiscrimination in Federally assisted programs. The COMPANY has signed an Assurance of Compliance with the nondiscriminatory provisions of the Act. Additionally, this Agreement is subject to the Trafficking Victims Protection Act of 2000, as amended (22 U.S.C. chapter 78), Executive Order 13627, Strengthening Protections Against Trafficking in Persons in Federal Contracts, the international Traffic in Arms Regulations (22 C.F.R. Part 120, et seq.), the National Industrial Security Program Operating Manual (NISPOM) (DoD 5220.22-M), the Department of Commerce's Export Administration Regulations (15 C.F.R. Part 730, et seq.), and the Federal Property and Administrative Services Act (40 U.S.C. chapter 5), to the extent applicable to the activities to be conducted under this Agreement. In addition, the Procurement integrity Act (41 U.S.C. §2101-2107) shall apply to this Agreement.

ARTICLE 19: INDEMNITY

19.1. The COMPANY shall defend, indemnify and hold the Government harmless (including payment of all reasonable costs, attorneys' fees, settlements and damages) from any actions brought against Government to the extent that it is based on a claim that the Products or Documentation infringe any U.S. registered copyright of any third party, provided that: (i) the COMPANY is promptly notified in writing of the claim; (ii) the COMPANY has sole control of the investigation, preparation, defense, and/or settlement of such claim, and the Government does not settle such claim without the COMPANY's consent; and (iii) at the COMPANY's request and expense, Government provides reasonable assistance and information to the COMPANY. Nothing contained herein shall be deemed to contradict or contravene the authority of the Department of Justice as per 28 USC §516.

19.2. In the event of any such infringement claim, the COMPANY may at its sole option:

1. replace the infringing Products with functionally equivalent software;
 2. modify such Products to render the same non- infringing, while retaining substantively equivalent functionality
-

3. procure for the Government a license to continue to use such Products under the terms of this Agreement; or

4. if the foregoing are not commercially reasonable, direct the Government to terminate use of such Products. If the COMPANY directs Government to terminate use of such Products (or a permanent injunction is issued against such use), the COMPANY shall refund any prepaid unearned fees as of the date of the termination.

19.3. Notwithstanding the foregoing, the COMPANY will have no liability with respect to any claim that arises from any such infringement claim to the extent that it results from: (i) use, operation, or combination of the Products or Documentation with programs, data, equipment, or materials not provided by the COMPANY if such infringement would have been avoided by the use of the Products or Documentation without such other programs, data, equipment, or materials; (ii) modifications to the Products made by a party other than COMPANY or its agents; (iii) data accessed or generated by the Products (including, without limitation Third Party Materials); (iv) the combination, operation or use of the Products with equipment, devices, data or software not provided or approved by COMPANY; (v) the Government's failure to use updated or modified versions of the Products provided by COMPANY to avoid a claim; (vi) COMPANY's compliance with any specifications or requirements provided by Government; or (vii) the Government's use of the Products other than in accordance with this Agreement.

19.4. This article specified the Government's sole and exclusive remedy and the COMPANY'S sole and exclusive obligation with respect to the infringement of intellectual property rights.

19.5. The Government shall not indemnify any entity. The Government agrees to pay for any loss, liability or expense, which arises out of or relates to the Government's acts or omissions with respect to its obligations hereunder, where a final determination of liability on the part of the Government is established by a court of law, or where settlement has been agreed to by the Government agency with, where appropriate, the coordination of the Department of Justice. This provision shall not be construed to limit the Government's rights, claims or defenses which arise as a matter of law or pursuant to any other provision of this Agreement

ARTICLE 20: ASSIGNMENT AND TRANSFER

Neither Party may assign, reassign, or transfer such Party's rights and obligations under this Agreement without the prior written consent of the other Party, provided that (1) the Government may delegate or transfer its administrative authority over this Agreement to a different Agreements Officer within the U.S. Department of Defense, and (2) nothing herein shall be construed to preclude Company from assigning proceeds under this Agreement in accordance with the Assignment of Claims Act. Any assignment, reassignment or transfer is subject to payment of then- current license and support fees, as applicable for the number of Applications required by such assignee or transferee

ARTICLE 21: FORCE MAJEURE

Neither Parties failure or omission in the performance of any obligation of this Agreement shall be deemed a breach of this Agreement or create any liability if the same shall arise from any cause or causes beyond the control of the Parties, including but not limited to, the following: acts of God; Acts or omissions of any Government; Any rules, regulations or orders issued by any Governmental authority or by any officer, department, and agency or instrumentality thereof; fire; storm; flood; earthquake; accident; war; rebellion;

insurrection; riot; and invasion and provided that such failure or omission resulting from one of the above causes is cured as soon as is practicable after the occurrence of one or more of the above mentioned cause.

ARTICLE 22: ORDER OF PRECEDENCE

In the event of any inconsistency between the terms and conditions of this Agreement and language set forth in the Attachments, the inconsistency shall be resolved by giving precedence in the following order: (1) The Agreement, and (2) all Attachments to the Agreement.

ARTICLE 23: MISCELLANEOUS

23.1. Entire Agreement. This Agreement constitutes the entire agreement of the Parties and supersedes all prior and contemporaneous agreements, understandings, negotiations, and discussions among the Parties, whether oral or written, with respect to the subject matter hereof.

23.2. Severability. To the extent permitted by applicable law, the parties hereby waive any provision of law that would render any clause of this Agreement invalid or otherwise unenforceable in any respect. If a provision of this Agreement is held to be invalid or otherwise unenforceable, such provision will be interpreted to fulfill its intended purpose to the maximum extent permitted by applicable law, and the remaining provisions of this Agreement will continue in full force and effect.

23.3. Headings. The headings appearing at the beginning of the sections contained in this Agreement have been inserted for identification and reference purposes only and shall not be used in the construction and interpretation of this Agreement.

23.4. Counterparts. This Agreement, or modifications thereto, may be executed in counterparts each of which shall be deemed as original, but all of which taken together shall constitute one and the same instrument.

ATTACHMENT 1: STATEMENT OF WORK
STATEMENT OF WORK

for

Autonomous EOD Maritime Response Vehicle

1.0 BACKGROUND:

Navy Explosive Ordnance Disposal (EOD) forces are manned, trained and equipped to neutralize or remove explosive hazards in the maritime and undersea environment to enable Naval and Joint force maneuver. The possible operational environments range from permissive to hostile. The physical environment also varies, including deep sea, littorals, very shallow water and surf zone, protected harbors and ports. Common to the disparate potential use cases is the requirement for highly mobile, rapidly deployable, highly reliable and sustainable solutions.

In contested operating environments, the presence of EOD operators in the operational area may present an unacceptable risk to force. In these circumstances the capability to conduct the full spectrum of EOD tasks using autonomous vehicles with a human-on-the-loop is desirable. To accomplish this, autonomous vehicles must be capable of detecting, localizing, navigating to, inspecting, identifying and – with human consent – neutralizing mine-like objects on the seafloor, in the water column, and at the water surface.

2.0 OBJECTIVE/SCOPE

The objective of this project is to develop a prototype autonomous EOD maritime response vehicle. To accomplish this, the Navy, in partnership with DIU, will retrofit the Navy's fielded Remotely Operated Vehicles (ROVs) with additional embedded hardware and software. Mature commercial technologies will be integrated onto the Navy's Mk 20 Mod 0, commercially marketed as the VideoRay Mission Specialist Series Defender.

The prototype will be evaluated on its ability to conduct the detect-to-engage spectrum of EOD tasks autonomously, the affordability of additional hardware components and software licenses, and interoperability with other Navy systems. The government will also consider the impact of data rights assertions.

Per this agreement, the program intends to procure prototype systems for government and fleet evaluation. The primary objective of this prototype phase is to integrate mature commercial off the shelf (COTS) technology onto fielded Navy ROVs to yield a new prototype system. To achieve this objective the program will evaluate the prototype system against the advertised government need, the manufacturer's advertised performance criteria, and the performance parameters outlined in section 4.0 of this agreement. The prototype system will be evaluated through a series of operationally relevant characterization and demonstration events to ensure effectiveness and suitability. These evaluations will be completed with various stakeholder Subject Matter Expert (SME) input, including fleet end-users.

3.0 APPLICABLE DOCUMENTS

- MIL-STD 810
- MIL-STD 461
- MIL-STD 129R
- Common Operator Interface Navy (COIN) Software Development Kit (SDK)
- Neptune/SOLAR SDK
- Mine Countermeasures Sensor Hierarchical Data Format (HDF) Specification
- VideoRay MSS Defender ICD

4.0 TECHNICAL REQUIREMENTS:

4.1 Task 1: Conduct Contract Kick-Off Meeting

4.1.1 The government shall host a virtual contract kick-off meeting with the contractor within 5 business days of contract award. The government shall provide a high-level overview of the *Task 4: Mine-Like Object Perception Demonstration* at the kickoff meeting.

4.1.2 The contractor shall provide a time-phased integrated master schedule (IMS) in an excel spreadsheet at the kick-off meeting. The contractor shall assume that all subsequent priced optional milestones described below will be exercised within 14 days of completion of *Task 4: Mine-Like Object Perception Demonstration* event. In addition to the IMS, the contractor shall provide any subcontractor dependencies, "must-have" requirements, long lead time items and risk matrices.

4.1.3 The contractor shall ensure that subcontractors are represented at the kickoff meeting.

4.1.4 The contractor shall provide a list of personnel that will require access to the Government-owned Secure Unclassified Network (SUNet) environment no later than the Kick-Off Meeting. Every individual that requires access to SUNet will meet the following requirements: have completed the DoD Annual [Cyber Awareness Challenge](#) within the 6 months prior to contract award, sign the [SUNet User Agreement](#), submit required personal information (country of citizenship, contact information etc) to the government point of contact.

4.1.5 The government shall furnish SUNet login credentials to all contractor personnel who correctly complete access requirements within 21 days of receipt.

4.1.6 This task will exit successfully upon end of the Kickoff meeting and delivery of the specified materials.

4.2 Task 2: Data Collection Event 1

4.2.1 The government shall furnish a Computer-Assisted Design (CAD) digital file of a mine-like object within 14 days of contract award which will be transmitted through SUNet.

4.2.2 The government shall host a 1 to 2 day data collection event for the contractor at the Naval Information Warfare Center - Pacific (NIWC-PAC) within 30 days of contract award.

4.2.3 The contractor shall participate in Data Collection Event 1 at NIWC-PAC. The contractor shall collect data at this event utilizing the combination of sensors (sonar and electro-optical [E-O]) that will be subsequently used to develop and train the object detection & tracking algorithm for *Task 4: Mine-Like Object Perception Demonstration*.

4.2.4 The contractor shall, at Data Collection Event 1, facilitate the collection of data for the government to use as a validation set in later testing. The contractor shall assist the government in gathering data using the contractor's sensors, and saving the collected data to a separate government furnished data storage device. This data shall not be retained by the contractor, or used - in whole or in part - in the training of the contractors object detection & tracking algorithm prior to *Task 4: Mine-Like Object Perception Demonstration*.

4.2.5 This task will exit successfully upon collection of data for contractor use and delivery of validation data to the Government.

4.3 Task 3: Data Collection Event 2

4.3.1 The government shall host a 1 to 2 day data collection event for the contractor at the NIWC-PAC no later than 30 days prior to the start of *Task 4: Mine-Like Object Perception Demonstration*.

4.3.2 The contractor shall participate in Data Collection Event 2 at NIWC-PAC. The contractor shall collect data at this event utilizing the combination of sensors (sonar and E-O) that will be subsequently used to develop and train the object detection & tracking algorithm for *Task 4: Mine-Like Object Perception Demonstration*.

4.3.3 The contractor shall, at Data Collection Event 2, facilitate the collection of data for the government to use as a validation set in later testing. The contractor shall assist the government in gathering data using the contractors sensors, and saving the collected data to a separate government furnished storage device. This data shall not be retained by the contractor, or used - in whole or in part - in the training of the contractors object detection & tracking algorithm prior to *Task 4: Mine-Like Object Perception Demonstration*.

4.3.4 This task will exit successfully upon collection of data for contractor use and delivery of validation data to the Government.

4.4 Task 4: Mine-Like Object Perception Demonstration

4.4.1 The contractor shall participate in an object perception demonstration at NIWC-PAC within 4 months of contract award. The object perception demonstration may include an in-simulation evaluation of object recognition algorithm performance and a live in-water demonstration of the perception subsystem. The perception system sensors are not required to be integrated onto a vehicle for the purposes of this demonstration, and may be manually controlled by an operator. Additionally, the object recognition algorithms are not required to run on embedded hardware for the purposes of this demonstration. The demonstration will evaluate the object detection & tracking algorithm based on the following criteria:



In addition the government shall assess the perception system qualitatively based on characteristics such as accuracy and precision of distance to object estimates, form factor compatibility, size, weight and power usage (SWAP).

4.4.2 The contractor shall deliver a copy of the object detection & tracking algorithm not later than 5 days prior to the object detection demonstration. The object detection & tracking algorithm shall be delivered to the government in the Secure Unclassified Network (SUNet).

4.4.3 The contractor shall deliver a copy of the labeled training dataset (real and synthetic) used to train the object detection & tracking algorithm delivered under section 4.4.2. The dataset shall be delivered to the government in the Secure Unclassified Network (SUNet).

4.4.4 The contractor shall deliver a report to the government no later than 5 days prior to the object detection demonstration. The report shall include:

- An analysis of the feasibility of deploying the demonstrated object recognition algorithm to embedded hardware aboard the Mk 20, Mod 0 (VideoRay MSS Defender ROV).
- The report should also detail any required hardware updates to the Mk 20, Mod 0 that the contractor views as necessary.
- An analysis of how the contractor would approach generating excerpts from the post-ATR processed sensor data that is optimized for transmission over bandwidth constrained communications links - specifically acoustic communications links.

4.4.5 This task will exit successfully upon completion of the demonstration event and delivery of the specified materials.

4.5 Task 5: Monthly Report

4.5.1 The contractor shall prepare monthly reports covering project tasks including build, delivery, testing, training, development, feedback, and recommendations. Reports will be submitted through the project folder on the Defense Intelligence Information Enterprise (<https://www.di2e.net/>). Report contents will be further refined between the government and the contractor over the period of performance.

4.5.2 The contractor shall provide a list of personnel that will require access to the project DI2E project folder no later than the Kick-Off Meeting

4.5.3 This task will exit successfully upon completion of the Task 4 demonstration event and delivery of the specified materials.

4.6 Task 6: Bi-Weekly Meeting

4.6.1 The contractor will host virtual bi-weekly update meetings with the government team. Topics will include status updates on build, delivery, testing, training, development, feedback, and recommendations. In addition any schedule deviations, changes to the status of long lead time items, significant changes to risk matrices, and other items with the potential to impact project success at the contractors discretion. Bi-weekly meeting agenda will be further refined between the government and the contractor over the period of performance.

4.6.2 This task will exit successfully upon completion of the Task 4 demonstration event and delivery of the specified materials.

4.7 Task 7: Preliminary Design Review (PDR)

4.7.1 The contractor shall host a PDR meeting within 30 days After Option Exercise (AOE) and submit supporting documentation no later than 48 hours prior to the PDR meeting.

4.7.2 The contractor shall include the following items in the PDR documentation: overall preliminary system description, overall block diagram and component specifications, preliminary CAD models for prototype vehicle, to include any planned new sensor integrations, preliminary SWaP estimates/budgets, preliminary interface control documentation (ICDs), preliminary software architecture and a list of long lead items with cost and dates required for procurement to support on-schedule delivery, risk matrices, dependencies and impacts.

4.7.3 The government shall review the PDR within 7 days and notify the contractor of approval or any deficiencies.

4.7.4 The contractor shall not proceed to later milestones without the express written direction of the Agreements Officer.

4.7.5 This task will exit successfully upon completion of the PDR meeting, delivery of specified materials, and delivered response government notice of approval or deficiencies.

4.8 Task 8: Critical Design Review (CDR)

4.8.1 The contractor shall host a CDR meeting within 90 days AOE and submit supporting documentation no later than 48 hours prior to the CDR meeting.

4.8.2 The contractor shall include the following items in the CDR documentation: overall final system description, overall block diagram and component specifications, final CAD models for prototype vehicle, to include any planned new sensor integrations, final SWaP estimates/budgets, interface control documentation (ICDs), software architecture and a status update on long lead items with cost and dates required for procurement to support on-schedule delivery, risk matrices, dependencies and impacts.

4.8.3 The government shall review the PDR within 7 days and notify the contractor of approval or any deficiencies.

4.8.4 The contractor shall not proceed to later milestones without the express written direction of the Agreements Officer.

4.8.5 This task will exit successfully upon completion of the PDR meeting, delivery of specified materials, and delivered response government notice of approval or deficiencies.

4.9 Task 9: Hardware-in-the-Loop Demonstration:

4.9.1 The contractor shall host a hardware-in-the-loop demonstration either virtually or at the contractor's location within 5 months AOE.

4.9.2 The contractor shall demonstrate the integration of the perception subsystem onto the vehicle, and demonstrate the ability of those algorithms to provide useful data to the autonomy subsystem. The object recognition algorithms are required to run on embedded hardware for the purposes of this demonstration.

4.9.3 The contractor may use their own proprietary simulation environments or an open-source simulation environment - such as Gazebo.

4.9.4 This task will exit successfully upon end of the demonstration event.

4.10 Task 10: 50% Prototype Build & Tethered Autonomy Demonstration

4.10.1 The contractor shall notify the government when the prototype vehicle reaches 50% completion, no later than 8 months AOE.

4.10.2 The contractor shall participate in a tethered autonomy demonstration at NIWC-PAC within 8 months AOE. The tethered autonomy demonstration will demonstrate the prototype's ability to navigate to a point, given coordinates, reacquire a known object type, based on autonomous perception systems, conduct an inspection of the object, identify the object and notify the operator of the result. The demonstration may include live in-water demonstration in both controlled clear and turbid water environments.

4.10.3 The contractor shall demonstrate the ability to maneuver and navigate autonomously, and safely relative to the object in controlled clear or turbid water environments. The autonomy and navigation subsystems are required to operate on embedded hardware. The operator may pass commands to the vehicle over a tethered connection for the purposes of this demonstration, but surface computing resources shall not be used by the vehicle.

4.10.4 The contractor shall demonstrate the integration of the perception subsystem onto the vehicle, and demonstrate the ability of the object detection & tracking algorithm to provide data to the autonomy subsystem. The object recognition algorithms are required to run on embedded hardware for the purposes of this demonstration.

4.10.5 This task will exit successfully upon end of the demonstration event.

4.11 Task 11: Prototype Completion & Untethered Autonomy Demonstration I

4.11.1 The contractor shall deliver a complete prototype within 12 months AOE. The contractor shall demonstrate the integration of all subsystems onto the vehicle.

4.11.2 The contractor shall participate in an untethered autonomy demonstration at NIWC-PAC in controlled clear or turbid environments within 12 months AOE. The untethered autonomy demonstration will demonstrate the prototype's ability to navigate to a point, given coordinates, reacquire a known object type based on autonomous perception systems, and conduct an inspection of the object, identify the object and notify the operator of the result.

4.11.3 The government and contractor shall refine the parameters of this demonstration prior to award.

4.11.4 This task will exit successfully upon end of the demonstration event.

4.12 Task 12: Interface Control Documentation Delivery

4.12.1 The contractor shall deliver a comprehensive ICD for the prototype and its subsystems within 15 months AOE.

4.12.2 The contractor shall include as part of the ICD deliverable,

- Hardware:
 - Power required: Voltage level, amps, peak amps, nominal amps
 - Mounting: mounting hole patten and thread size
 - Weight in air
 - Weight in water
-

- Depth rating
- Connector types and connector pin outs
- Software:
 - CPU requirement, (MFLOPs)
 - Memory space for code execution
 - Hard disk space for binary
 - IP address
 - Data protocols
 - Data input requirement to include data format, and expected frequency
 - Data output to include data format, and output frequency
 - Hard disk space for output data
 - File format for output data

4.12.3 This task will exit successfully upon delivery of the ICD.

4.13 Task 13: Environmental Testing Support

4.13.1 The contractor shall provide environmental testing support to the government of up to 100 hours in order to support the hardening and ability of the prototype to work in various environments (warm/cold water, vibrations, etc). The contractor shall support the government by providing technical expertise in system operation, training, troubleshooting, debugging, and updating firmware to address critical issues that occur during testing.

4.13.2 This task will exit successfully upon complete utilization of the allocated hours, or completion of the test events whichever occurs first.

4.14 Task 14: Open Architecture Compliance Report Delivery

4.14.1 The contractor shall have a physical and operating architecture capable of hosting compatibility-designed third party software and or hardware payloads that can be reconfigured in the field.

4.14.2 The contractor shall provide a report within 15 months AOE, documenting compliance with the Navy's Unmanned Maritime Autonomy Architecture (UMAA). The report shall document any instances where existing UMAA interface control documentation does not exist or is insufficient, and the contractor's recommendation to remedy the deficiency.

4.14.3 This task will exit successfully upon delivery of the compliance report.

4.15 Task 15: Automated Target Recognition Library Expansion 1

4.15.1 The government will provide up to 4x physical mine-surrogates, mine-simulators, or mine-like object shapes, or digital representations thereof.

4.15.2 The contractor will collect, label and deliver labeled training datasets of the GFE-objects into SUNet, no later than 3 months AOE.

4.15.3 The contractor will upgrade the prototype's perception system to detect, classify and identify the mine-surrogates, mine-simulators, and or mine-like object shapes, in diverse environmental conditions, and diverse physical conditions.

4.15.4 This task exits upon delivery of both the training datasets and delivery of the updated perception subsystem software.

4.16 Task 16: Automated Target Recognition Library Expansion 2

4.16.1 The government will provide up to 4x physical mine-surrogates, mine-simulators, or mine-like object shapes, or digital representations thereof.

4.16.2 The contractor will collect, label and deliver labeled training datasets of the GFE-objects into SUNet, no later than 3 months AOE.

4.16.3 The contractor will upgrade the prototype's perception system to detect, classify and identify the mine-surrogates, mine-simulators, and or mine-like object shapes, in diverse environmental conditions, and diverse physical conditions.

4.16.4 This task exits upon delivery of both the training datasets and delivery of the updated perception subsystem software.

4.17 Task 17: Automated Target Recognition Library Expansion 3

4.17.1 The government will provide up to 4x physical mine-surrogates, mine-simulators, or mine-like object shapes, or digital representations thereof.

4.17.2 The contractor will collect, label and deliver labeled training datasets of the GFE-objects into SUNet, no later than 3 months AOE.

4.17.3 The contractor will upgrade the prototype's perception system to detect, classify and identify the mine-surrogates, mine-simulators, and or mine-like object shapes, in diverse environmental conditions, and diverse physical conditions.

4.17.4 This task exits upon delivery of both the training datasets and delivery of the updated perception subsystem software.

4.18 Task 18: Payload Delivery Behavior Integration & Untethered Autonomy Demonstration 2

4.18.1 The contractor shall deliver an incremental software and hardware upgrade to the vehicle which enables autonomous delivery of government-furnished render safe/neutralization payload. The prototype is not required to affix the payload directly to the target.

4.18.2 The contractor shall demonstrate the ability to deliver the payload within specified standoff of the target. The prototype is not required to affix the payload directly to the target.

4.18.3 The government and contractor shall refine the parameters of this demonstration, including the timeline for execution, and negotiate cost prior to award.

4.18.4 This task will exit successfully upon end of the demonstration event.

4.19 Task 19: Integrate Alternate Sensor Payload 1

4.19.1 The government shall provide as GFE, or contractor may provide, an alternate Electro-Optical (E-O) sensor, or combination E-O & acoustic sensor payload for the prototype.

4.19.2 The contractor shall fully integrate the E-O sensor, or combination E-O/acoustic sensor, into the prototype to demonstrate the modularity of the system architecture.

4.19.3 The contractor and government shall negotiate the schedule and cost of additional sensor payload integration prior to award of this option.

4.19.4 The exit criteria for this task will be negotiated prior to award of this option.

4.20 Task 20: Integrate Alternate Sensor Payload 2

4.20.1 The government shall provide as GFE, or contractor may provide, an alternate Electro-Optical (E-O) sensor, or combination E-O & acoustic sensor payload for the prototype.

4.20.2 The contractor shall fully integrate the E-O sensor, or combination E-O/acoustic sensor, into the prototype to demonstrate the modularity of the system architecture.

4.20.3 The contractor and government shall negotiate the schedule and cost of additional sensor payload integration prior to award of this option.

4.20.4 The exit criteria for this task will be negotiated prior to award of this option.

4.21 Task 21: Integrate Alternate Sensor Payload 3

4.21.1 The government shall provide as GFE, or contractor may provide, an alternate Electro-Optical (E-O) sensor, or combination E-O & acoustic sensor payload for the prototype.

4.21.2 The contractor shall fully integrate the E-O sensor, or combination E-O/acoustic sensor, into the prototype to demonstrate the modularity of the system architecture.

4.21.3 The contractor and government shall negotiate the schedule and cost of additional sensor payload integration prior to award of this option.

4.21.4 The exit criteria for this task will be negotiated prior to award of this option.

4.22 Task 22: Integrate Alternate Communications Payload

4.22.1 The government shall provide as GFE, or contractor may provide, an alternate communications payload for the prototype.

4.22.2 The contractor shall fully integrate the communications payload into the prototype to demonstrate the modularity of the system architecture.

4.22.3 The contractor and government shall negotiate the schedule and cost of additional communications payload integration prior to award of this option.

4.22.4 The exit criteria for this task will be negotiated prior to award of this option.

4.23 Task 23: Engineering Services I

4.23.1 The contractor shall provide engineering service support to the government of up to 100 hours in order to support and participate in cyber testing, supply chain analysis, operational testing and failure analysis/correction, if required by the government. The contractor shall support the government by providing technical expertise in system operation, training, troubleshooting, debugging, and updating firmware to address critical issues that occur during testing.

4.23.2 The contractor shall prepare and submit a report summarizing test results, root cause analysis of any system failures during testing, and recommendations for future system improvements.

4.23.3 The contractor and government shall negotiate the cost of engineering services support prior to award of this option.

4.23.4 This task will exit successfully upon complete utilization of the allocated hours.

4.24 Task 24: Engineering Services 2

4.24.1 The contractor shall provide engineering service support to the government of up to 100 hours in order to support and participate in cyber testing, supply chain analysis, operational testing and failure analysis/correction if required by the government. The contractor shall support the government by providing technical expertise in system operation, training, troubleshooting, debugging, and updating firmware to address critical issues that occur during testing.

4.24.2 The contractor shall prepare and submit a report summarizing test results, root cause analysis of any system failures during testing, and recommendations for future system improvements.

4.24.3 The contractor and government shall negotiate the cost of engineering services support prior to award of this option.

4.24.4 This task will exit successfully upon complete utilization of the allocated hours.

4.25 Task 25: Engineering Services 3

4.25.1 The contractor shall provide engineering service support to the government of up to 100 hours in order to support and participate in cyber testing, supply chain analysis, operational testing and failure analysis/correction if required by the government. The contractor shall support the government by providing technical expertise in system operation, training, troubleshooting, debugging, and updating firmware to address critical issues that occur during testing.

4.25.2 The contractor shall prepare and submit a report summarizing test results, root cause analysis of any system failures during testing, and recommendations for future system improvements.

4.25.3 The contractor and government shall negotiate the cost of engineering services support prior to award of this option.

4.25.4 This task will exit successfully upon complete utilization of the allocated hours.

4.26 Task 26: Delivery of two (2) Prototypes

4.26.1 The contractor shall order long lead items and third party products within ten (10) days of initial receipt of funds.

4.26.2 The contractor shall notify the government when the order is placed.

4.26.3 The contractor shall notify the government when vehicle construction/assembly commences, is 50% complete, and when fully assembled and ready for contractor quality assurance testing.

4.26.4 The contractor shall perform a pressure chamber depth rating test of fully assembled contractor prototype and provide the government with written documentation of the test.

4.26.5 The contractor shall deliver to the government the two (2) prototypes which shall include all completed improvements/upgrades (if funded, and as described in Section 4 of this document) if completed before the initial receipt of funds, and all ancillary support equipment.

4.26.6 The contractor and government shall negotiate the schedule and cost for prototype delivery prior to award of this option.

4.26.7 This task will exit successfully upon government acceptance of the two prototypes.

4.27 Task 27: Conduct Government Operator Training

4.27.1 The contractor shall provide a 2-day operator training course followed by a 1-day maintainer course to designated government employees, at a location of the government's choosing. Course size not to exceed six (6) students.

4.27.2 The government shall provide feedback on the training following delivery of the course.

4.27.3 The contractor and government shall negotiate the schedule and cost for Operator Training prior to award of this option.

4.27.4 This task will exit successfully upon the end of the 2 day operator training course and the 1 day maintainer course.

5.0 TECHNICAL APPROACH

5.1 Background

The desire to remove human capital from harm's way in complex and dangerous maritime mine countermeasure missions (MCMs) has been a goal of the US Navy for years, and robotic assets are playing a central role in achieving this goal. However, current subsea robotics technology limits the extent and degree in which these assets can be effectively utilized. The state-of-the-art software and hardware in small unmanned systems has created fault intolerant control systems and platforms which rely on significant operator input for any 'autonomous' actions in unstructured environments. Manipulation of objects subsea is inherently difficult using the current 'state-of-the-art' technology because the relative interaction dynamics between the vehicle and the desired object are not appropriately compensated for in the software and hardware stack. Due to this, current implementations of MCM location and neutralization technology on small unmanned systems still rely heavily on high bandwidth data links between vehicles and topside vessels in proximity, unnecessarily exposing the warfighter to danger.

As operators are required in the current technological paradigm, so are vessels. Vessels currently remain essential because of their utility in the long-range transport, deployment, and retrieval of the subsea robotic assets at the target site and more importantly, supporting the tether that enables high-bandwidth communications and power to the vehicle. Presently, no technological solutions exist within the Navy that enables the performance of complex subsea robotic manipulation and intervention tasks without the necessity of a topside vessel nearby. This technological gap will continue to unnecessarily subject warfighters to dangerous conditions while operating subsea assets due to the constraints of the robot and associated umbilical. This proposal provides a novel, but COTS, implementation of Houston Mechatronics' (HMI) core software stack, Nautilus, and pairs the software and autonomous architecture with the present Navy's Mk 20 Mod 0 Remotely Operated Vehicle (ROV) platform. This pairing enables complex runtime autonomous behaviors and the inclusion of perception hardware on a small platform. When implemented fully, we believe that the MK20 Mod 0 will have the capability to detect and classify targets of interest, navigate to them and around them, and place an object on them – all autonomously – and without a tether.

5.1.1 Prior work

HMI has developed the Nautilus software platform over the past 5 years. In that time Nautilus has grown from a mission management and control architecture to a comprehensive software package for mission simulation, mission management, communication management, perception processing and enablement, reporting, and vehicle actuation. Nautilus enables subsea vehicles to perform inspection and intervention tasks within a sliding scale of autonomy. Comprised of the following components listed in Figure 1. The

Nautilus stack permits tether-less operational paradigms, effectively removing the need for an immediate surface expression over or near the area of operations. With Nautilus, Operators can deploy the vehicle at an initial safe standoff distance (ISSD) and transit to the minimum safe standoff distance (MSSD) to execute identification and neutralization missions. The vehicle carries out mission directives through user defined behaviors and has the capacity to react to dynamic and unstructured environmental conditions. Each component of Nautilus communicates through UMAA compliant message descriptions, enabling integration onto existing platforms and interaction with other existing tools that adhere to the standard. Commander is the primary user interface of Nautilus. Operators interact with Commander in order to view data from a platform, approve or disapprove of semi-autonomous actions, and take direct control of a platform. Commander may be used on platforms that do, and do not, have the ability to manipulate the environment. As shown in Figure 2, Commander's interface provides both mission planning, feedback, and management capability to operators. Commander loads synthetic objects in a 'digital twin' style as well as mission data in world coordinates.

Helmsman is the on-vehicle deployment of the Nautilus package which handles platform actuation, safety management, and platform control. Helmsman takes input from other components of Nautilus and determines how to translate that into safe actions for the platform. For example, if a user commands a vehicle to move 5 m to the east, Commander will send this command to a vehicle. Helmsman, running on the vehicle, will then translate and coordinate all actuation required to achieve the goal sent from Commander.

Wayfinder is the perception-oriented component of Nautilus. Wayfinder takes in sensor data and generates world modeling from the sensor data. Wayfinder supports 2-D and 3-D sensors like stereo optics and sonars. In order to support new sensors, the HMI team writes drivers for those sensors.

Wavelink is the communications component of Nautilus. HMI does not believe that subsea communications should be tied to a master/slave pair as they have for over three decades. Wavelink allows meshed Delay Tolerant Networking between a vehicle and an operator. Wavelink allows vehicles to seamlessly communicate with any topside infrastructure which is also powered by WaveLink communications.

Loggerhead is the low-level logging, payload data collection, processing, and report generation component of the Nautilus software architecture. Loggerhead was originally a critical tool used by HMI roboticists for actuator development as it allowed playback of any timeseries data collected by a robotic system. Now, as part of Nautilus, this low-level functionality has been paired with higher level data collection and processing capabilities to bridge the gap between raw and processed data. Autonomous mission planning, execution, and management in Nautilus utilizes behavior trees for complex fault tolerance. Originally found in game theory, behavior trees enable a fallback-style mission planning and execution. As shown in Figure 3, a behavior tree is a modular architecture for task execution. Complex subtasks can be represented as their own nested behavior tree. In this architecture, a tick source is set up and analyzes the state of all actions in the tree. If an action produces 'Success' the tree will progress to the next node. If an action produces a 'Fail', then the tree reverts to the previous node.

Behavior trees are runtime compiled and are as fault tolerant as users may make them. Therefore, this style of mission planning and execution is significantly more flexible than commonly deployed subsea software architectures.

An example which illustrates this is presented below. In our previous work Nautilus was deployed to execute a supervised autonomous task that localized and interacted with moored mines. The Nautilus component WayFinder was trained to detect hertz cone moored mines and generate pose estimates in the world frame in which Aquanaut, HMI's autonomous subsea robotic platform, could manipulate a tool to neutralize the threat. If Aquanaut failed an action the robot autonomously attempted the action again until an operator intervened.

In Figure 4 and 5, a simulated, inert moored mine was placed in the test area to act as the target of interaction. At a data rate of less than 3kbit/s, an operator commanded the vehicle to approach the mine and maintain position in order to attach a simulated disruptor charge placed on the mine in a user specified location. The experiment was executed 25 times to demonstrate the ability to dynamically replan to the same desired location even when the environment changed between each attempt.

In other work, HMI has also demonstrated completely autonomous and far more advanced subsea manipulation activities. In phase I of DARPA's Angler program, custom behaviors were executed within Nautilus component Commander to enable Aquanaut to detect and classify an object within a designated

circular error probable (CEP) distance, retrieve an electrical cable and connector typically found in subsea oilfield fields, transited to a separate location where it identified the receptacle, and ultimately inserted the lead into its designated location.

Prior to the generation of this proposal HMI inserted the MK20 Mod 0 vehicle into our simulation environment. We modeled collection and processing of data via the optical sensor proposed for this project as well as autonomous control of the platform (Figure 6)

During this simulation, the Nautilus software was able to register the mine based on simulated point cloud data, direct the vehicle to the mine, and direct the vehicle to orbit the mine.

Figure 6. A MK20 Mod 0 platform shown in commander. Behaviors are located on the right for '1-button' click, and scene controls are on the left.

5.2 Objectives

The successful completion of this program will result in sensor package and software capabilities implemented on the MK20 Mod 0 that enable the vehicle to autonomously detect, navigate to, communicate with an operator, and neutralize the threat using various tools provided to the vehicle.

To satisfy DIU requirements in the base scope of work, HMI will first implement a robust sensing and detection capability through Wayfinder. Helmsman will be installed on a VideoRay Defender and will serve as the vehicle controller. Commander will be utilized as a User Interface and as a platform which deploys autonomous behaviors to the vehicle. HMI's proprietary machine learning pipeline, Hypnos, will be used to do data capture, annotate, generate models, and version control over deployed models.

In Option 1 of this scope of work HMI will deploy additional components of Nautilus to achieve greater vehicle autonomy. Specifically, Wavelink will be deployed with Subnero hardware to enable acoustic communication.

In Option 2 of this scope of work HMI will extend the platform to capture different payloads and models.

5.2.1 Base Scope of Work [SOW 4.1 - 4.4]

Before navigating to and neutralizing a mine, the vehicle must first classify the mine and localize it in relation to its current position. To date, this has typically been accomplished by torpedo shaped AUVs, incapable of station keeping and interacting with the environment. This has led to a collaborative approach between AUVs and human-operated, tethered ROVs. By enabling platforms like the MK20 Mod 0 with the appropriate sensing, autonomy, communications, and energy storage to accomplish autonomous work, human operators will be afforded a larger operational standoff distance. The vehicles currently fielded within the MESR program do not contain the compute platforms, nor the energy systems, necessary for untethered operation capabilities. In order to accomplish the base scope of work goals, HMI intends to integrate a perception package that will be capable of locating Targets-of-Interest (TOI) at various distances and turbidity conditions and generate models of specified customer objects to be executed in WayFinder. Existing offboard computer and power systems will be utilized as requested and specified in the SOW. Specifically, WayFinder will be deployed to detect and classify mine-like objects of known characteristics and determine both the distance and direction of those objects relative to the vehicle.

The ultimate objective of Phase I is to deploy a sensing solution capable of detecting mine-like objects utilizing the data collection events (SOW 4.2, 4.3), HMI will capture data in various positions and orientations in relation to the mine-like object to best inform the sensor kinematics to best perceive the environment and generate meaningful data for analysis. Additionally, the selected optical and sonar sensors will be characterized regarding distance capabilities, acoustic signature, lighting requirements, and abilities to operate in varying turbidity. The data sets generated during the initial collection events will serve as the starting point for model creation to be used by WayFinder. Follow on collection events will be used to further advance the models that are classifying the objects. This will be done by evaluating the models and identifying features that were not detected and added to the training pipeline.

Following successful completion of the data collection events and model creation, HMI will execute a demonstration using the perception system, running WayFinder on a topside compute solution. The ability to track the TOIs will be assessed quantitatively using provided metrics (SOW 4.4), and the perception system will be assessed using qualitative metrics of accuracy and precision to target, form factor, and SWaP.

5.2.2 Option 1 – Untethered Autonomy Objectives [SOW 4.7-4.17]

Once a robust perception system and detection framework have been established, the data will be used to facilitate the autonomous transit of the vehicle to complete further inspection of the object in this option period. In order to achieve semi-autonomous capabilities on the MK20 Mod 0, the full Nautilus software platform will be configured for deployment on the vehicle. Initial efforts will begin with configuring Helmsman to control the vehicle and expose the underlying access to the vehicle through a Hardware Abstraction Layer (HAL). Once exposed, existing control inputs through the operator console will be available; however, a feature rich control interface will be exposed for interaction with Commander. In parallel to the controller implementation, behaviors will be created for execution on the vehicle to replicate standard tactics, techniques, and procedures (TTPs) employed by operators. These behaviors are both event-driven and reactive to ensure a robust response to disturbances and unknowns in the environment.

To achieve true tether-less operation, an incremental approach to autonomy is undertaken. The current MK20 Mod 0 system does not contain compute or energy storage on board. As to not hinder progress towards the autonomy solution, a tethered demonstration will allow for validation of software capabilities without hardware restricting progress. Parallel to the software effort, a hardware effort to implement sufficient compute and energy will be realized on the vehicle.

Once the functionality of the autonomy framework has been validated and the vehicle upgrades are realized, fully autonomous tether-less operation can be accomplished. The objective of this demonstration will showcase the ability to fulfill the requirements provided [SOW 4.11.2]. HMI will deliver one (1) complete prototype vehicle to the Government at the conclusion of the demonstration.

5.2.3 Option 2 – Payload Delivery Objectives [SOW 4.18 - 4.27]

Neutralization and sensing payloads can vary greatly just as the threats the vehicle might encounter may vary. For this reason, it is imperative that the vehicle and supporting software can be easily adaptable to exchange payloads given the requirements of the operators. This option period will focus on the electromechanical interfaces of the vehicle, and the autonomy software that knows how to deploy the payload through actuation or making use of the sensed data.

Neutralization of a mine-like object requires the vehicle to reason what has been found, and more importantly, the appropriate steps for that specific item. Utilizing the identification libraries established through the program, behaviors will be created to utilize the provided neutralization device. This will include approach strategies, minimum stand-off distances, placement requirements, and actuations once commanded.

The vehicle can only neutralize what it can perceive in the environment. In order to expand the ability of the vehicle to detect and classify TOIs, provided sensors will be integrated onto the vehicle. This will consist of ensuring compatible electromechanical interfaces and drivers for sensors that expose data into WayFinder.

Upon successful demonstration of payload deployment and additional sensor integration, HMI will deliver 2 fully operational prototypes. These prototypes will have been upgraded with VideoRay's advancements in thruster performance, communications backbone throughput, energy storage solution and on-board compute. HMI will install the additional WaveLink communications capabilities and all developed Nautilus components realized during the program.

5.3.0 Approach

HMI will utilize its Nautilus software platform configured to operate on the MK20 Mod 0 vehicle. This will consist of first implementing WayFinder to detect and classify TOIs and localize them in reference to the sensor frame. Once the perception system has been established and validated, Helmsman will be deployed to the vehicle to expose telemetry and system controls to Commander and WayFinder for autonomous operation. With WayFinder and Helmsman deployed on the MK20 Mod 0, autonomous behaviors will be created in Commander to navigate to and interrogate TOI. The remaining effort will be implementing WaveLink to communicate with the vehicle after deployment. This acoustic communication link will serve as the link between the operator and vehicle for tasks that must be verified by a human-in-the-loop before action is executed by the vehicle.

5.3.1 Mine-Like Object Perception (Base Scope)

The initial effort in the Base Scope of work will be the data collection of mine-like objects provided by the

customer [SOW 4.2, 4.3]. Once this data is collected and initial models are created, HMI will then implement these models within WayFinder and will focus on performance considerations for future on-hardware development.

Initial model creation can suffer from 2 different fitting issues: underfitting and overfitting. Underfitting occurs when the model for classification is too simple and cannot identify the underlying trend of the training sets. Overfitting occurs when the model for classification has been trained with a substantial volume of data where the algorithm begins to consider the noise and inaccuracies in the training sets as valid data. These two fitting issues are well understood by HMI and procedures have been established to follow when collecting initial training sets. These procedures consist of varying the angles of observation, creating skewed and partial measurements, and ensuring that enough variety of representations exist in both the training and test data sets. With this abundance of data, fitting issues will be minimized by ensuring variety in observations and providing adequate training and testing data sets.

Once high-quality data is collected for training, the data will be processed in Hypnos. In the Hypnos pipeline, data sets are labeled, and parameters of a convolutional neural network (CNN) are specified. Additionally, synthetic data is generated from CAD models provided of the objects of interest. This synthetic data is then programmatically altered to create a rich data set for training and testing of the generated model.

Once the processing pipeline is established and vetted, HMI will validate the algorithms and record initial fit metrics. This will take place in both pool and open water locations to ensure that no one modality is biased in the development process.

Evaluation of the models generated during the initial data collection event will inform the optimal arrangement of the sensors. At follow on data collection events, HMI will mount a Numurus 3DX-C Smart Sensor and a Blueprint Subsea Oculus 750D on a VideoRay Defender vehicle for baselining the accuracy of the models. Mounting the sensors on a vehicle allows for evaluation of the robustness of the model's ability to detect objects with motion experienced in deployment. During the data collection period, the existing models will be executed to determine their accuracy and further characterize the performance of the algorithm against the metrics of evaluation provided in SOW 4.4.1. Evaluating the performance of the current models, false positives and missed detections will further refine features of detection and update the training sets accordingly.

As stated earlier, the ultimate objective of Phase I is to deploy WayFinder with the ability to detect and classify mine-like objects of known characteristics and determine both the distance and direction relative to the vehicle. The class, distance, and direction will be published to a data bus that complies with UMAA standards. As in the previous data collection event, HMI's demonstration will be executed with the sensors mounted on a surrogate vehicle. The operator will be provided a user interface that displays the sensed data, detection results, and pose estimation of objects of interest. Additionally, all pub/sub and services for the detected objects will be available for HMI's autonomy framework.

5.3.2 Untethered Autonomy (Option 1)

In order to achieve untethered autonomy, two distinct efforts must be undertaken: (1) implement a control system and autonomy framework that compensates for disturbances and uncertainties in the environment without the immediate intervention of an operator, and (2) implement a compute and energy solution onboard the MK20 Mod 0 that can enable transit and processing all sensor, control, and autonomy data.

5.3.2.1 Helmsman, Commander, and WaveLink

The typical approach taken with designing a controller for an AUV/ROV is to use a Proportional-Integral-Derivative (PID) feedback controller. For many situations a well-tuned PID controller can work sufficiently; however, the presence of the integral gain in the PID controller can be problematic when interacting with the environment or using payloads that constrain the vehicle's motion.

In the case of a vehicle equipped with a manipulator or payloads that constrain movement, the integral term of a PID may cause propulsor saturation because the propulsors are unable to move the anchored system.

There are heuristics for handling integrator saturation, each of which add complexity to the tuning and have their own technical drawbacks. Integrators can be slow since it takes time for error to build up enough to result in vehicle motion. Alternative control methods, such as Model Predictive Control (MPC), do not rely on traditional feedback terms and, thus, are not susceptible to the problems associated with integral control. This is precisely why Helmsman employs an MPC for control.

Helmsman is largely agnostic to the underlying hardware platform both in theory and implementation.

However, it does rely on reasonably known kinematic and dynamic models that, by definition, are specific to the vehicle and payload. HMI has completed initial estimation of the model parameters in simulation of the specified vehicle and will continue to refine the system throughout the course of this program. These initial parameters will be verified on hardware during the base scope of work. For Helmsman to be realized on hardware, a hardware abstraction layer (HAL) will be created for the existing MK20 Mod 0 system to access the propulsors and this layer will be exposed through Helmsman. Once integrated into Helmsman, these systems will be made available through UMAA compliant messages. This will ensure that, not only can the autonomy framework control the vehicle, but the existing operator interface is left unchanged. Once fully realized, all actuation (manipulation, propulsors, and payloads) will be available for use within behaviors implemented within Commander. Upon migration to a vehicle, additional work will be necessary for WayFinder to operate properly with the onboard hardware sensing package. An additional HAL will be created to access the sensors on board and to pass along state estimation data to WayFinder for world model generation. Once incorporated into WayFinder, this sensor data will be published on the data bus in UMAA compliant message format.

In order to accomplish the requirements of this option phase, behaviors will be created in Commander to accomplish desired functionality specified in SOW 4.11. The vehicle will be capable of executing search and survey patterns in specified areas, detect and classify TOIs, conduct in close inspection and validation of identification, and communicate its findings with an operator over an acoustic communication's link. Even with autonomy on board the vehicle, conditions exist where an operator is still desired to be involved in the outcome of an action or in order to validate data. In the absence of a tether, acoustic modems are utilized to establish a communications link which enables operator input. Acoustic modems are limited in throughput, typically transmitting data at speeds of 3kbps or slower. To compensate for that, Nautilus ensures that minimal amount of data needs to be exchanged to communicate, encapsulating the complexity of actions on board the vehicle and by utilizing existing libraries of TOIs. WaveLink will be implemented on board the MK20 Mod 0 in order to exchange data between operators and vehicle.

5.3.2.2 MK20 Mod 0 Vehicle Modifications

In order to facilitate tether-less operations of the MK20 Mod 0, several hardware upgrades to the platform will be accomplished through the option period. The two primary tasks are to install a battery module (both NiMH and Li-Ion varieties) and migrate the compute capabilities to a module onboard the vehicle. The implementation of these two capabilities, along with a Nautilus implementation, will result in a vehicle capable of operating tether-less.

VideoRay's NiMH solution is currently in testing and is moving to production. This capability will provide the vehicle with endurance of 1-3 hours and charge times of 4 hours. The Lithium-Ion variants are in the final stages of design and are being prepared for testing. HMI proposes that this program is used to accelerate the timeline of testing for certification in order to realize the additional energy performance and capacity that can be gained over the available NiMH offering. The Lithium-Ion solution will provide 1.3-4 hours with charge times of only 2 hours. Expediting the certification of the Lithium-Ion batteries will ultimately increase the vehicle's available power and battery life expectancy over the NiMH offering. The current MK20 Mod 0 relies on a topside control station for all computation. For autonomy to be enabled for the system, a compute solution must be implemented. VideoRay will deliver a compute solution that is comprised of a Nvidia Xavier NX and upgraded networking capabilities, enhancing the network speed of 100mb/s to 1Gb/s. The Xavier is a System-on-Chip (SOC) that couples a GPU capable of 21TOPS to process the machine learning components of WayFinder and 6 Caramel ARM CPUs to execute the rest of the Nautilus software suite. In addition to the autonomy software, the compute module will execute system health and power system monitoring. These monitors will be advertised on the data bus in UMAA compliant messages.

5.3.3 Payload and Prototype Delivery (Option 2)

Incorporation of payloads are addressed through systematic approach of power, data, establishing a Helmsman compatible HAL, and finally behavior creation. With the flexibility of Helmsman to easily integrate new actuators and subsequent behaviors simple incremental advancements can be realized without software rework. HMI will establish a workflow with the customer to validate the new capabilities through validation in both simulation and real-world testing. HMI proposes that each evolution shall not exceed 3 months.

Upon successful completion of the previous option period, HMI and VideoRay will deliver 2 fully capable systems that can execute all behaviors and incorporate all payloads required throughout the program. HMI develops all software and robotic autonomous behaviors with the ability to be executed in simulation. This has resulted in a framework that allows both developers and operators to validate software in a way that truly obfuscates the knowledge if a physical system is being controlled or a simulated one. This same simulation framework will be delivered as a training tool for operators, in addition to the in-person training they will receive by our operators. Training

5.3.3 IP Assertions -See Attachment 4, Data Assertions List within the resultant Agreement.

6.0 Deliverable Schedule:

Paragraph Reference	Deliverable	Frequency	Due Date	Delivery Method
4.1.2	Integrated Master Schedule (IMS)	Once	Kickoff Meeting	Electronic
4.1.4	SUNet Access Roster	Once	Kickoff Meeting	Electronic
4.4.2	Object Detection & Tracking Algorithm	Once	NLT 5 Days Prior to Object Perception Demonstration	Electronic via SUNet
4.4.3	Labeled Object Perception Training Dataset	Once	NLT 5 Days Prior to Object Perception Demonstration	Electronic via SUNet
4.4.4	Object Perception Report	Once	NLT 5 Days Prior to Object Perception Demonstration	Electronic via SUNet
4.5.1	Monthly Report	Monthly	Monthly	Electronic via D12E
4.7.1	PDR	Once	28 Days AOE	Electronic via D12E
4.8.1	CDR	Once	88 Days AOE	Electronic via D12E
4.11.1	Complete Prototype Vehicle	Once	12 Months AOE	Physical to NIWC-PAC
4.12.1	Interface Control Documentation	Once	15 Months AOE	Electronic via D12E
4.14.2	UMMA Compliance Report	Once	15 Months AOE	Electronic via D12E
4.15.2	ATR Expansion 1 – Labeled Dataset	Once	3 Months AOE	Electronic via SUNet
4.16.2	ATR Expansion 2 – Labeled Dataset	Once	3 Months AOE	Electronic via SUNet
4.17.2	ATR Expansion 3 – Labeled Dataset	Once	3 Months AOE	Electronic via SUNet
4.18.1	Neutralization Payload Spiral Upgrades	Once	TBD	Physical to NIWC-PAC
4.26.5	Two (2) Prototypes Delivery	Once	TBD	Physical to NIWC-PAC
4.27.1	Operator & Maintainer Training	Once	TBD	Physical to NIWC-PAC

7.0 MILESTONE SCHEDULE

Milestone	Task Number	Milestone Description
1	4.1	Kick-off Meeting
2	4.2	Data Collection Event 1
3	4.3	Data Collection Event 2
4	4.4	Object Perception Demonstration
5	4.5	Monthly Reporting
6	4.6	Bi-Weekly Update Calls
7	4.7	Preliminary Design Review
8	4.8	Critical Design Review
9	4.9	Hardware-in-the-Loop Demonstration
10	4.10	Tethered Autonomy Demonstration

11	4.11	Untethered Autonomy Demonstration 1
12	4.12	Interface Control Document Delivery
13	4.13	Environmental Testing Support
14	4.14	UMMA Compliance Report Delivery
15	4.15	ATR Expansion 1
16	4.16	ATR Expansion 2
17	4.17	ATR Expansion 3
18	4.18	Untethered Demonstration 2
19	4.19	Sensor Payload Integration 1
20	4.20	Sensor Payload Integration 2
21	4.21	Sensor Payload Integration 3
22	4.22	Communication Payload Integration 1
23	4.23	Engineering Services 1
24	4.24	Engineering Services 2
25	4.25	Engineering Services 3
26	4.26	Two (2) Prototypes Delivery
27	4.27	Operator & Maintainer Training

7.0 DATE OF COMPLETION. The Date of Completion for this Agreement is twenty-four (24) months after the date of award, as depicted in block 3, of the SF 26, or as otherwise determined by the Agreements Officer.

8.0 PLACE OF PERFORMANCE:

- 8.1 TRANSDEC
420 Transdec Rd
San Diego, CA 92106
- 8.2 Houston Mechatronics
17146 Feather Craft Ln #450
Webster, TX 77598
- 8.3 Houston Mechatronics – Lake Travis
20811 Dawn Dr. #604
Lago Vista, TX 78645

9.0 GOVERNMENT FURNISHED EQUIPMENT/INFORMATION/PERSONNEL:

SOW Ref	Date Required	Description
Task 2 4.2.1 - 4.2.4	Within 30 days of contract	Digital file of Mine Like Object Access to surrogate Mine Like Object shape for data collection Access to TRANSDEC for data collection event 1
Task 3 4.3.1 - 4.3.3	NLT 30 days before demonstration	Access to surrogate Mine Like Object shape for data collection Access to TRANSDEC for data collection event 2
Task 4 4.4.1 - 4.4.4	Within 4 months of contract	Access to surrogate Mine Like Object shape for demonstration Access to TRANSDEC for demonstration
Task 10	NLT 8	Access to surrogate Mine Like Objects for demonstration

4.10.2 - 4.10.4	months AOE	Access to TRANSDEC for demonstration Access to PIER for demonstration
Task 11 4.11.1 - 4.11.2	NLT 12 months AOE	Access to surrogate Mine Like Objects for demonstration Access to TRANSDEC for demonstration Access to PIER for demonstration
Task 15 4.15.1 - 4.15.2	NLT 1 week AOE	Digital file of Mine Like Objects Access to surrogate Mine Like Objects shapes for data collection Access to TRANSDEC and PIER for expansion 1 data collection
Task 16 4.16.1 - 4.16.2	NLT 5 weeks AOE	Digital file of Mine Like Objects Access to surrogate Mine Like Objects shapes for data collection Access to TRANSDEC and PIER for expansion 2 data collection
Task 17 4.17.1 - 4.17.2	NLT 9 weeks AOE	Digital file of Mine Like Objects Access to surrogate Mine Like Objects shapes for data collection Access to TRANSDEC and PIER for expansion 3 data collection
Task 18 4.18.1 - 4.18.4	NLT 1 week AOE O2	Digital files of Neutralization Payload Access to Neutralization Payload for electromechanical interface validation. Equipment actuation checkout Drawings of electromechanical interfaces to Neutralization Payload Interface documentation of Neutralization Payload
Task 19 4.19.1-4.19.4	TBD	Digital files of Alternate Sensor Payload Access to Alternate Sensor Payload for electromechanical interface validation. Equipment operation checkout Drawings of electromechanical interfaces to Alternate Sensor Payload Interface documentation of Alternate Sensor Payload
Task 20 4.20.1-4.20.4	TBD	Digital files of Alternate Sensor Payload Access to Alternate Sensor Payload for electromechanical interface validation. Equipment operation checkout Drawings of electromechanical interfaces to Alternate Sensor Payload Interface documentation of Alternate Sensor Payload
Task 21 4.21.1- 4.21.4	TBD	Digital files of Alternate Sensor Payload Access to Alternate Sensor Payload for electromechanical interface validation. Equipment operation checkout Drawings of electromechanical interfaces to Alternate Sensor Payload Interface documentation of Alternate Sensor Payload
Task 22 4.22.1 - 4.22.4	TBD	Digital files of Alternate Communications Payload Access to Alternate Communications Payload for electromechanical interface validation. Equipment operation checkout Drawings of electromechanical interfaces to Alternate Communications Payload Interface documentation of Alternate Communications Payload

10.0 SECURITY:

10.1

[REDACTED]

11.0 ACCEPTANCE CRITERIA AND SUCCESS METRICS:

The Autonomous EOD Maritime Response Vehicle effort seeks to prototype a system capable of detecting, identifying, localizing, navigating to, inspecting, and neutralizing mine-like objects on the seafloor, in the water column. A successful prototype system is characterized through the following criteria:

[REDACTED]

[REDACTED]

[REDACTED]

[REDACTED]

[REDACTED]

[REDACTED]

[REDACTED]

[REDACTED]

[REDACTED]

[REDACTED]

[REDACTED]



[REDACTED]

12.0 INTELLECTUAL PROPERTY/DATA RIGHTS:

12.1 All proposed Non-Commercial and/or Commercial Intellectual property associated with the systems shall be addressed in Attachment 4: Data Assertions List and Attachment 5, EULA of the DIU Other Transaction Agreement, Terms and Conditions.

12.2 For purposes of data developed under this Agreement for prototype purposes, the Government shall have Government Purpose Rights (GPR). This expressly includes data collected for the purposes of training object detection & tracking algorithms, and any associated training data both real and synthetic.

ATTACHMENT 2: WIDE AREA WORKFLOW INSTRUCTIONS

A. Payments will be made by the Defense Finance and Accounting Service office, as indicated below, within thirty (30) calendar days of an accepted invoice in the government provided invoicing and payment system.

B. Unless otherwise stated, the COMPANY is required to utilize the Wide Area Work Flow (WAWF) system when processing invoices and receiving reports under this Agreement. WAWF is a secure web-based system for electronic invoicing, receipt and acceptance. WAWF application enables electronic form submission of invoices, Government inspection, and acceptance documents in order to support DoD's goal of moving to a paperless acquisition process. Authorized DoD users are notified of pending actions by e-mail and are presented with a collection of documents required to process the contracting or financial action. It uses Public Key Infrastructure (PKI) to electronically bind the digital signature to provide non-reputable proof that the user electronically signed the document with the contents. Benefits include online access and full spectrum view of document status, minimized re-keying and improving data accuracy, eliminating unmatched disbursements and making all documentation required for payment easily accessible. The COMPANY shall:

1. Ensure an Electronic Business Point of Contact is designated within the System for Award Management at <http://www.sam.gov>.
2. Register to use WAWF-RA at the <https://wawf.eb.mil> site. Step-by-step procedures to register are available at the <https://wawf.eb.mil> site. The COMPANY is directed to use the "2-N-1" invoice format when processing invoices.
3. Document routing. The COMPANY shall use the information in the Routing Data Table below only to fill inapplicable fields in WAWF when creating payment requests and receiving reports in the system.

ROUTING DATA TABLE

Field Name in WAWF	Data to be entered in WAWF
Pay Official DoDAAC	HQ0339
Issue By DoDAAC	HQ0845
Admin DoDAAC	HQ0845
Inspect By DoDAAC (if applicable)	HQ0833
Ship To Code (if applicable)	HQ0833
Service Approver (DoDAAC)	HQ0833
Service Acceptor (DoDAAC)	HQ0833

C. Payment request and supporting documentation. The COMPANY shall ensure a payment request includes appropriate line item and subline item descriptions of the work performed as detailed in the SOW for specific milestones.

D. WAWF email notifications. The COMPANY shall enter the email address identified below in the "**Send Additional Email Notifications**" field of WAWF once a document is submitted in the system.

[REDACTED] and

Agreements Officer Representative as defined in Attachment 3

E. The COMPANY may obtain clarification regarding invoicing in WAWF from the following contracting activity's administrative WAWF point of contact. For technical WAWF help, contact the WAWF help desk at 866-618-5988.

F. The following guidance is provided for invoicing processed under this Agreement through WAWF:

1. The AOR identified in Attachment 3, "Agreement Administration" shall continue to formally inspect and accept the deliverables/milestones. To the maximum extent practicable, the AOR shall review the deliverable(s) milestone report(s) and either:

- a. provide a written notice of rejection to the COMPANY which includes feedback regarding deficiencies requiring correction or
- b. written notice of acceptance to the AO.

2. Acceptance within the WAWF system shall be performed by the DIU Financial Management team upon receipt of a confirmation email, or other form of transmittal, from the AOR.

3. The COMPANY agrees, when entering invoices entered in WAWF to utilize the contract line item number (CLIN) (please use 000I) and accounting classification reference number (ACRN) associated with each milestone as detailed in Section B. The description of the CLIN shall include reference to the associated milestone number along with other necessary descriptive information. The COMPANY agrees that the Government may reject invoices not submitted in accordance with this provision.

G. Note for DFAS: The Agreement shall be entered into the DFAS system by CLIN - Milestone association (MS)/ACRN as delineated in Section B. The Agreement is to be paid out by CLIN (MS)/ACRN. Payments shall be made using the CLIN (MS)/ACRN association as delineated at Section B.

H. Payee Information: As identified at Central Contractor Registration, i.e., Commercial and Government Entity (CAGE) Code, Dun & Bradstreet number (DUNS), and Tax Identification Number (TIN). Payments shall be made in the amounts set forth in the SOW, provided the AOR has verified the completion of the milestones.

ATTACHMENT 3: AGREEMENT ADMINISTRATION

Below is a list of the Points of Contact for the COMPANY and the Government. Each Party may change its representatives named below by written notification to the other party. The Government will affect the change following the procedures in Article II, subparagraph C.3. of the main text of the Agreement.

A. Government Points of Contact:

[REDACTED]

[REDACTED]

[REDACTED]

B. COMPANY's Points of Contact

Program Manager:

Name: Charles Blakely

Phone: 832.729.0787

Email: cblakely@houstonmechatronics.com

Administrative/Contracting:

Name: Reg B. Berka, Chief Operating Officer

Phone: 281.942.9069

Email: rberka@houstonmechatronics.com

ATTACHMENT 4: DATA ASSERTIONS LIST

In accordance with Article 10 - Data Rights, Houston Mechatronics Inc is asserting data rights on Non-commercial Technical Data or Computer Software. The Government's rights to use, release, or disclose the following technical data or computer software should be restricted as shown below:

Non-Commercial Technical Data/Computer Software/Patents to be Furnished With Restrictions**	Basis for Assertion***	Asserted Rights Preference****	Name or Person Asserting Restrictions*****
HMI Nautilus Software Commander Wavelink Helmsman Wayfinder Loggerhead Reef Shipyard Minnow Manipulation autonomy software Sortie Manager Perception Processing World Model Hypnos Vehicle Simulation System	Developed exclusively under private expense	Commercial subject to EULA	Houston Mechatronics, Inc.
*Note: Commercial license rights as specified in Article 10 - Data Rights, and the COMPANY End User License Agreement (EULA) attached hereto as Attachment 4.			

The software stack inserted in the table above was developed to support our commercial product Aquanaut 100% under private expense. HMI does not anticipate changes to compiled software to support this program. The prototype vehicle is delivered with a perpetual evaluation license that allows for operation of the vehicle. The cost of the license(s) is included in tasks 4.11 and 4.26, as referenced in the Statement of Work.

Patents

The following patents may be applicable to this scope of work:
 Patent Number: US Patent Application 15/449,803
 Title: RE-CONFIGURABLE SUBSEA ROBOT
 Inventor name(s): Nicolas Radford, John Yamokoski, and Chad Tobler
 Assignee: Houston Mechatronics, Inc
 Filing Date: March 3, 2017

ATTACHMENT 5: EULA

**HOUSTON MECHATRONICS
 SOFTWARE END USER LICENSE AGREEMENT**

THIS SOFTWARE END USER LICENSE AGREEMENT, including the Order Form which by this reference is incorporated herein (this "**Agreement**"), is a binding agreement between **HOUSTON MECHATRONICS, INC.**, having an address of 17146 Feathercraft Lane, Webster, Texas 77598 ("**Licensor**"), and the person or entity identified on the Order Form as the licensee of the Software ("**Licensee**").

LICENSOR PROVIDES THE SOFTWARE SOLELY ON THE TERMS AND CONDITIONS SET FORTH IN THIS AGREEMENT AND ON THE CONDITION THAT LICENSEE ACCEPTS AND COMPLIES WITH THEM. BY ORDERING

THE SOFTWARE YOU (A) ACCEPT THIS AGREEMENT AND AGREE THAT LICENSEE IS LEGALLY BOUND BY ITS TERMS; AND (B) REPRESENT AND WARRANT THAT: (I) YOU ARE OF LEGAL AGE TO ENTER INTO A BINDING AGREEMENT; AND (II) IF LICENSEE IS A CORPORATION, GOVERNMENTAL ORGANIZATION, OR OTHER LEGAL ENTITY, YOU HAVE THE RIGHT, POWER, AND AUTHORITY TO ENTER INTO THIS AGREEMENT ON BEHALF OF LICENSEE AND BIND LICENSEE TO ITS TERMS. IF LICENSEE DOES NOT AGREE TO THE TERMS OF THIS AGREEMENT, LICENSOR WILL NOT AND DOES NOT LICENSE THE SOFTWARE TO LICENSEE AND YOU MUST NOT USE THE SOFTWARE OR DOCUMENTATION.

NOTWITHSTANDING ANYTHING TO THE CONTRARY IN THIS AGREEMENT OR YOUR OR LICENSEE'S ACCEPTANCE OF THE TERMS AND CONDITIONS OF THIS AGREEMENT, NO LICENSE IS GRANTED (WHETHER EXPRESSLY, BY IMPLICATION, OR OTHERWISE) UNDER THIS AGREEMENT, AND THIS AGREEMENT EXPRESSLY EXCLUDES ANY RIGHT, CONCERNING ANY SOFTWARE THAT LICENSEE DID NOT ACQUIRE LAWFULLY OR THAT IS NOT A LEGITIMATE, AUTHORIZED COPY OF LICENSOR'S SOFTWARE.

1. Definitions. For purposes of this Agreement, the following terms have the following meanings:

"**Authorized Users**" means the following individual persons authorized to use the Software pursuant to the license granted under this Agreement: employees of Licensee and any contractors or agents of Licensee using the Software on behalf of Licensee.

"**Documentation**" means user manuals, technical manuals, and any other materials provided by Licensor, in printed, electronic, or other form, that describe the installation, operation, use, or technical specifications of the Software.

"**Intellectual Property Rights**" means any and all registered and unregistered rights granted, applied for, or otherwise now or hereafter in existence under or related to any patent, copyright, trademark, trade secret, database protection, or other intellectual property rights laws, and all similar or equivalent rights or forms of protection, in any part of the world.

"**Licensee**" has the meaning set forth in the preamble.

"**License Fees**" means the license fees, including all taxes thereon, paid or required to be paid by Licensee for the license granted under this Agreement, and as designated on the Order Form.

"**Licensor**" has the meaning set forth in the preamble.

"**Order Form**" means the order form filled out and submitted by or on behalf of Licensee, and accepted by Licensor, for Licensee's purchase of the license for the Software granted under this Agreement.

"**Person**" means an individual, corporation, partnership, joint venture, limited liability company, governmental authority, unincorporated organization, trust, association, or other entity.

"**Software**" means the software programs for which Licensee is purchasing a license, as expressly set forth in the Order Form.

"**Term**" has the meaning set forth in Section 1.

"**Third Party**" means any Person other than Licensee or Licensor.

"**Update**" means updates, bug fixes, patches, and other error corrections as Licensor may make generally available to licensees of the Software then entitled to maintenance and support services, such services provided under a separate set of terms and conditions which may be included with, and incorporated into, the Order Form.

2. License Grant and Scope. Subject to and conditioned upon Licensee's payment of the License Fees and Licensee's strict compliance with all terms and conditions set forth in this Agreement, Licensor hereby grants to Licensee a non-exclusive, non-transferable, non-sublicensable, limited license during the Term to use, solely by and through its Authorized Users, the Software and Documentation, solely as set forth in this Section 2 and subject to all conditions and limitations set forth in Section 1 or elsewhere in this Agreement. This license grants Licensee the right, exercisable solely by and through Licensee's Authorized Users, to:

(a) Use and run the Software as properly installed in accordance with this Agreement and the Documentation, solely as set forth in the Documentation and solely for Licensee's internal business purposes. Such use is permitted only on the computer hardware designated on the Order Form on which the Software is installed, and owned or leased, and controlled by, Licensee.

(b) Download or otherwise make copies of the Documentation and use such Documentation, solely in support of its licensed use of the Software in accordance herewith. All copies of the Documentation made by Licensee (i) will be the exclusive property of Licensor; (ii) will be subject to the terms and conditions of this Agreement; and (iii) must include all trademark, copyright, patent, and other Intellectual Property Rights notices contained in the original.

3. Third-Party Materials. The Software may include software, content, data, or other materials, including related documentation, that are owned by Persons other than Licensor and that are provided to Licensee on license terms that are in addition to and/or different from those contained in this Houston Mechatronics Software End User License Agreement (“**Third-Party Licenses**”). A list of all materials, if any, included in the Software and provided under Third-Party Licenses is set forth on Schedule A to this Agreement, and the applicable Third-Party Licenses are accessible via links therefrom. Licensee is bound by and shall comply with all Third-Party Licenses. Any breach by Licensee or any of its Authorized Users of any Third-Party License is also a breach of this Agreement.

4. Use Restrictions. Licensee shall not, and shall require its Authorized Users not to, directly or indirectly:

(a) use (including make any copies of) the Software or Documentation beyond the scope of the license granted under Section 2;

(b) provide any other Person, including any subcontractor, independent contractor, affiliate, or service provider of Licensee, with access to the Software or Documentation, provided that Authorized Users may use the Software;

(c) reverse engineer, disassemble, decompile, decode, or otherwise attempt to derive or gain access to the source code of the Software or any part thereof;

(d) remove, delete, alter, or obscure any trademarks or any copyright, trademark, patent, or other intellectual property or proprietary rights notices provided on or with the Software or Documentation, including any copy thereof;

(e) copy the Software or Documentation, in whole or in part;

(f) rent, lease, lend, sell, sublicense, assign, distribute, publish, transfer, or otherwise make available the Software, or any features or functionality of the Software, to any Third Party for any reason, whether or not over a network or on a hosted basis, including in connection with the internet or any web hosting, wide area network (WAN), virtual private network (VPN), virtualization, time-sharing, service bureau, software as a service, cloud, or other technology or service;

(g) use the Software or Documentation in, or in association with, the design, construction, maintenance, or operation of any hazardous environments or systems, for which it is not designed, including (i) power generation systems; (ii) aircraft navigation or communication systems, or air traffic control systems; and (iii) safety-critical applications, including medical or life-support systems;

(h) use the Software or Documentation in violation of any law, regulation, or rule; or

(i) use the Software or Documentation for purposes of competitive analysis of the Software, the development of a competing software product or service, or any other purpose that is to the Licensor’s commercial disadvantage.

5. Responsibility for Use of Software. Licensee is responsible and liable for all uses of the Software and Documentation through access thereto provided by Licensee, directly or indirectly. Specifically, and without limiting the generality of the foregoing, Licensee is responsible and liable for all actions and failures to take required actions with respect to the Software and Documentation by its Authorized Users or by any other Person to whom Licensee or an Authorized User may provide access to or use of the Software and/or Documentation, whether such access or use is permitted by or in violation of this Agreement.

6. Maintenance and Support. Maintenance and support for the Software shall be provided under a separate set of terms and conditions which may be included with, and incorporated into, the Order Form and the associated Exhibit related thereto.

7. Collection and Use of Information.

(a) Licensee acknowledges that Licensor may, directly or indirectly through the services of Third Parties, collect and store information regarding use of the Software and about equipment on which the Software is installed or through which it otherwise is accessed and used, through (i) the provision of maintenance and support services; and (ii) security measures included in the Software as described in Section **Error! Reference source not found.**

(b) Licensee agrees that the Licensor may use such information for any purpose related to any use of the Software by Licensee or on Licensee's equipment, including but not limited to (i) improving the performance of the Software or developing Updates; and (ii) verifying Licensee's compliance with the terms of this Agreement and enforcing the Licensor's rights, including all Intellectual Property Rights in and to the Software.

8. Intellectual Property Rights. – See below, and Article 12.0 Intellectual Property/Data Rights, in Agreement No. HQ0845-21-9-0031.

9. Licensee acknowledges and agrees that the Software and Documentation are provided under license, and not sold, to Licensee. Licensee does not acquire any ownership interest in the Software or Documentation under this Agreement, or any other rights thereto, other than to use the same in accordance with the license granted and subject to all terms, conditions, and restrictions under this Agreement. Licensor reserves and shall retain its entire right, title, and interest in and to the Software and all Intellectual Property Rights arising out of or relating to the Software, except as expressly granted to the Licensee in this Agreement. Licensee shall safeguard all Software (including all copies thereof) from infringement, misappropriation, theft, misuse, or unauthorized access. Licensee shall promptly notify Licensor if Licensee becomes aware of any infringement of the Licensor's Intellectual Property Rights in the Software and fully cooperate with Licensor in any legal action taken by Licensor to enforce its Intellectual Property Rights.

10. PAYMENT. – See Article 5, Obligation and Payment in Agreement No. HQ0845-21-9-0031.

11. Term and Termination – See Article 3, Term of the Agreement and Termination in Agreement No. HQ0845-21-9-0031.

12. Limited Warranties, Exclusive Remedy, and Disclaimer/Warranty Disclaimer – See Article 11, Software License in Agreement No. HQ0845-21-9-0031.

(a) Solely with respect to Software for which Licensor receives a License Fee, Licensor warrants that, for a period of thirty (30) days following the license date set forth on the Order Form, the Software will substantially contain the functionality described in the Documentation, and when properly installed on the authorized hardware set forth on the Order Form, or on a computer meeting the specifications set forth in, and operated in accordance with, the Documentation (if no specific authorized hardware is designated on the Order Form), will substantially perform in accordance therewith.

THE FOREGOING WARRANTY DOES NOT APPLY, AND LICENSOR STRICTLY DISCLAIMS ALL WARRANTIES, WITH RESPECT TO ANY THIRD-PARTY MATERIALS.

(b) The warranty set forth in Section 12(a) will not apply and will become null and void if Licensee breaches any material provision of this Agreement, or if Licensee, any Authorized User, or any other Person provided access to the Software by Licensee or any Authorized User, whether or not in violation of this Agreement, (i) installs or uses the Software on or in connection with any hardware or software not specified in the Order Form or Documentation (as applicable); (ii) modifies or damages the Software, or the media on which it is provided, including abnormal physical or electrical stress; or (iii) misuses the Software, including any use of the Software other than as specified in the Documentation.

(c) If, during the period specified in Section **12(a)**, any Software covered by the warranty set forth in such Section fails to perform substantially in accordance with the Documentation, and such failure is not excluded from warranty pursuant to the Section **12(b)**, Licensor will, subject to Licensee's promptly notifying Licensor in writing of such failure, at its sole option, either (i) repair or replace the Software, provided that Licensee provides Licensor with all information Licensor requests to resolve the reported failure, including sufficient information to

enable the Licensor to recreate such failure; or (ii) refund the License Fees paid for such Software, subject to Licensee's ceasing all use of and, if requested by Licensor, returning to Licensor all copies of the Software.

If Licensor repairs or replaces the Software, the warranty will continue to run from the initial date specified on the Order Form, and not from Licensee's receipt of the repair or replacement. The remedies set forth in this Section 12(c) are Licensee's sole remedies and Licensor's sole liability under the limited warranty set forth in Section 12(a).

(d) EXCEPT FOR THE LIMITED WARRANTY SET FORTH IN SECTION 12(a), THE SOFTWARE AND DOCUMENTATION ARE PROVIDED TO LICENSEE "AS IS" AND WITH ALL FAULTS AND DEFECTS WITHOUT WARRANTY OF ANY KIND. ALL FUTURE SUPPORT AND MAINTENANCE FOR THE SOFTWARE SHALL BE PROVIDED TO LICENSEE, IF SELECTED AND PAID FOR BY LICENSEE, UNDER SEPARATE TERMS AND CONDITIONS WHICH MAY BE INCLUDED WITH, AND INCORPORATED INTO, THE ORDER FORM AND THE ASSOCIATED EXHIBIT RELATED THERETO.

TO THE MAXIMUM EXTENT PERMITTED UNDER APPLICABLE LAW, LICENSOR, ON ITS OWN BEHALF AND ON BEHALF OF ITS AFFILIATES AND ITS AND THEIR RESPECTIVE LICENSORS AND SERVICE PROVIDERS, EXPRESSLY DISCLAIMS ALL WARRANTIES, WHETHER EXPRESS, IMPLIED, STATUTORY, OR OTHERWISE, WITH RESPECT TO THE SOFTWARE AND DOCUMENTATION, INCLUDING ALL IMPLIED WARRANTIES OF MERCHANTABILITY, FITNESS FOR A PARTICULAR PURPOSE, TITLE, AND NON-INFRINGEMENT, AND WARRANTIES THAT MAY ARISE OUT OF COURSE OF DEALING, COURSE OF PERFORMANCE, USAGE, OR TRADE PRACTICE. WITHOUT LIMITATION TO THE FOREGOING, THE LICENSOR PROVIDES NO WARRANTY OR UNDERTAKING, AND MAKES NO REPRESENTATION OF ANY KIND THAT THE LICENSED SOFTWARE WILL MEET THE LICENSEE'S REQUIREMENTS, ACHIEVE ANY INTENDED RESULTS, BE COMPATIBLE, OR WORK WITH ANY OTHER SOFTWARE, APPLICATIONS, SYSTEMS, OR SERVICES, OPERATE WITHOUT INTERRUPTION, MEET ANY PERFORMANCE OR RELIABILITY STANDARDS OR BE ERROR FREE, OR THAT ANY ERRORS OR DEFECTS CAN OR WILL BE CORRECTED.

13. Limitation of Liability – See Article 19: Indemnity of Agreement No. HQ0845-21-9-0031

14. Export Regulation. The Software and Documentation may be subject to US export control laws, including the Export Control Reform Act and its associated regulations. The Licensee shall not, directly or indirectly, export, re-export, or release the Software or Documentation to, or make the Software or Documentation accessible from, any jurisdiction or country to which export, re-export, or release is prohibited by law, rule, or regulation. The Licensee shall comply with all applicable federal laws, regulations, and rules, and complete all required undertakings (including obtaining any necessary export license or other governmental approval), prior to exporting, re-exporting, releasing, or otherwise making the Software or Documentation available outside the US.

15. US Government Rights. The Software is commercial computer software, as such term is defined in 48 C.F.R. §2.101. Accordingly, if the Licensee is the US Government or any contractor therefor, Licensee shall receive only those rights with respect to the Software and Documentation as are granted to all other end users under license, in accordance with (a) 48 C.F.R. §227.7201 through 48 C.F.R. §227.7204, with respect to the Department of Defense and their contractors, or (b) 48 C.F.R. §12.212, with respect to all other US Government licensees and their contractors.

16. Miscellaneous – See Article 23: Miscellaneous of Agreement No. HQ0845-21-9-0031

(a) Licensor will not be responsible or liable to Licensee, or deemed in default or breach hereunder by reason of any failure or delay in the performance of its obligations hereunder where such failure or delay is due to strikes, labor disputes, civil disturbances, riot, rebellion, invasion, epidemic, hostilities, war, terrorist attack, embargo, natural disaster, acts of God, flood, fire, sabotage, fluctuations or non-availability of electrical power, heat, light, air conditioning, or Licensee equipment, loss and destruction of property, or any other circumstances or causes beyond Licensor's reasonable control.

(b) All notices, requests, consents, claims, demands, waivers, and other communications hereunder shall be in writing and shall be deemed to have been given: (i) when

delivered by hand (with written confirmation of receipt); (ii) when received by the addressee if sent by a nationally recognized overnight courier (receipt requested); (iii) on the third day after the date mailed, by certified or registered mail, return receipt requested, postage prepaid. Such communications must be sent to the respective parties at the addresses set forth on the Order Form (or to such other address as may be designated by a party from time to time in accordance with this Section 16(b)).

(c) Licensee shall not assign or otherwise transfer any of its rights, or delegate or otherwise transfer any of its obligations or performance, under this Agreement, in each case whether voluntarily, involuntarily, by operation of law, or otherwise, without Licensor's prior written consent, which consent Licensor may give or withhold in its sole discretion. For purposes of the preceding sentence, and without limiting its generality, any merger, consolidation, or reorganization involving Licensee (regardless of whether Licensee is a surviving or disappearing entity) will be deemed to be a transfer of rights, obligations, or performance under this Agreement for which Licensor's prior written consent is required. No delegation or other transfer will relieve Licensee of any of its obligations or performance under this Agreement. Any purported assignment, delegation, or transfer in violation of this Section 16(c) is void. Licensor may freely assign or otherwise transfer all or any of its rights, or delegate or otherwise transfer all or any of its obligations or performance, under this Agreement only if the Licensee's consent has provided written consent. This Agreement is binding upon and inures to the benefit of the parties hereto and their respective permitted successors and assigns.

(d) This Agreement is for the sole benefit of the parties hereto and their respective successors and permitted assigns and nothing herein, express or implied, is intended to or shall confer on any other Person any legal or equitable right, benefit, or remedy of any nature whatsoever under or by reason of this Agreement.

(e) This Agreement may only be amended, modified, or supplemented by an agreement in writing signed by each party hereto. No waiver by any party of any of the provisions hereof shall be effective unless explicitly set forth in writing and signed by the party so waiving. Except as otherwise set forth in this Agreement, no failure to exercise, or delay in exercising, any right, remedy, power, or privilege arising from this Agreement shall operate or be construed as a waiver thereof; nor shall any single or partial exercise of any right, remedy, power, or privilege hereunder preclude any other or further exercise thereof or the exercise of any other right, remedy, power, or privilege.

(f) If any term or provision of this Agreement is invalid, illegal, or unenforceable in any jurisdiction, such invalidity, illegality, or unenforceability shall not affect any other term or provision of this Agreement or invalidate or render unenforceable such term or provision in any other jurisdiction.

(g) For purposes of this Agreement, (a) the words "include," "includes," and "including" shall be deemed to be followed by the words "without limitation"; (b) the word "or" is not exclusive; and (c) the words "herein," "hereof," "hereby," "hereto," and "hereunder" refer to this Agreement as a whole. Unless the context otherwise requires, references herein: (x) to Sections, Annexes, Schedules, and Exhibits refer to the Sections of, and Annexes, Schedules, and Exhibits attached to, this Agreement; (y) to an agreement, instrument, or other document means such agreement, instrument, or other document as amended, supplemented, and modified from time to time to the extent permitted by the provisions thereof and (z) to a statute means such statute as amended from time to time and includes any successor legislation thereto and any regulations promulgated thereunder. This Agreement shall be construed without regard to any presumption or rule requiring construction or interpretation against the party drafting an instrument or causing any instrument to be drafted. The Order Form and all Annexes, Schedules, and Exhibits referred to herein shall be construed with, and as an integral part of, this Agreement to the same extent as if they were set forth verbatim herein.

(h) The headings in this Agreement are for reference only and do not affect the interpretation of this Agreement.

ATTACHMENT 6: AFFIRMATION OF BUSINESS STATUS CERTIFICATION



AFFIRMATION OF BUSINESS STATUS CERTIFICATION (ABSC)

Every significant participating entity shall complete the following table and provide a signature representing its certification.



The Entity named above represents that it is (check one of the following boxes):

- A Nontraditional Defense Contractor (NDC) – A Nontraditional Defense Contractor is an entity that is not currently performing and has not performed, for at least the one-year period preceding the solicitation of sources by DoD for the procurement or transaction, any contract or subcontract for the DoD that is subject to full coverage under the cost accounting standards prescribed pursuant to section 1502 of title 41 and the regulations implementing such section (see 10 U.S.C. 2302(9)).
- A Nonprofit Research Institution – As defined in 15 U.S.C. 3703 a nonprofit institution means an organization owned and operated exclusively for scientific or educational purposes, no part of the net earnings of which inures to the benefit of any private shareholder or individual; and includes federally funded research and development centers, as identified by the National Scientific Foundation in accordance with the government wide Federal Acquisition Regulation issued in accordance with section 1303(a)(1) of title 41 (or any successor regulation thereto).
- A Traditional Defense Contractor – A Traditional Defense Contractor is an entity that does not meet the definition of a Nontraditional Defense Contractor (NDC).

The undersigned hereby certifies that the representations made herein are accurate and true regarding the entity identified above. I authorize my electronic signature to carry the same weight and legal effect as my written signature.



ATTACHMENT 7: PROHIBITION ON USE OF CERTAIN TELECOMMUNICATIONS AND VIDEO SURVEILLANCE SERVICES OR EQUIPMENT

Prohibition on Use of Certain Telecommunications and Video Surveillance Services or Equipment

This attachment is to ensure compliance with Section 889 of the John S. McCain National Defense Authorization Act for Fiscal Year 2019 (Pub. L. 115-232). Based on the information provided below, the Government may be unable to enter into an Agreement, exercise an option under an Agreement, or bilaterally modify the Agreement to extend the term of an Agreement with the Company.

(a) Definitions.

Backhaul means intermediate links between the core network, or backbone network, and the small subnetworks at the edge of the network (e.g., connecting cell phones/towers to the core telephone network). Backhaul can be wireless (e.g., microwave) or wired (e.g., fiber optic, coaxial cable, Ethernet).

Covered foreign country means The People's Republic of China.

Covered telecommunications equipment or services means—

- (1) Telecommunications equipment produced by Huawei Technologies Company or ZTE Corporation (or any subsidiary or affiliate of such entities);
- (2) For the purpose of public safety, security of Government facilities, physical security surveillance of critical infrastructure, and other national security purposes, video surveillance and telecommunications equipment produced by Hytera Communications Corporation, Hangzhou Hikvision Digital Technology Company, or Dahua Technology Company (or any subsidiary or affiliate of such entities);
- (3) Telecommunications or video surveillance services provided by such entities or using such equipment; or
- (4) Telecommunications or video surveillance equipment or services produced or provided by an entity that the Secretary of Defense, in consultation with the Director of National Intelligence or the Director of the Federal Bureau of Investigation, reasonably believes to be an entity owned or controlled by, or otherwise connected to, the government of a covered foreign country.

Critical technology means—

- (1) Defense articles or defense services included on the United States Munitions List set forth in the International Traffic in Arms Regulations under subchapter M of chapter I of title 22, Code of Federal Regulations;
 - (2) Items included on the Commerce Control List set forth in Supplement No. 1 to part 774 of the Export Administration Regulations under subchapter C of chapter VII of title 15, Code of Federal Regulations, and controlled-
 - (i) Pursuant to multilateral regimes, including for reasons relating to national security, chemical and biological weapons proliferation, nuclear nonproliferation, or missile technology; or
 - (ii) For reasons relating to regional stability or surreptitious listening;
 - (3) Specially designed and prepared nuclear equipment, parts and components, materials, software, and technology covered by part 810 of title 10, Code of Federal Regulations (relating to assistance to foreign atomic energy activities);
 - (4) Nuclear facilities, equipment, and material covered by part 110 of title 10, Code of Federal Regulations (relating to export and import of nuclear equipment and material);
-

(5) Select agents and toxins covered by part 331 of title 7, Code of Federal Regulations, part 121 of title 9 of such Code, or part 73 of title 42 of such Code; or

(6) Emerging and foundational technologies controlled pursuant to section 1758 of the Export Control Reform Act of 2018 (50 U.S.C. 4817).

Interconnection arrangements means arrangements governing the physical connection of two or more networks to allow the use of another's network to hand off traffic where it is ultimately delivered (e.g., connection of a customer of telephone provider A to a customer of telephone company B) or sharing data and other information resources.

Reasonable inquiry means an inquiry designed to uncover any information in the entity's possession about the identity of the producer or provider of covered telecommunications equipment or services used by the entity that excludes the need to include an internal or third-party audit.

Roaming means cellular communications services (e.g., voice, video, data) received from a visited network when unable to connect to the facilities of the home network either because signal coverage is too weak or because traffic is too high.

Substantial or essential component means any component necessary for the proper function or performance of a piece of equipment, system, or service.

(b) *Prohibition.*

(1) The Company is prohibited from providing to the Government any equipment, system, or service that uses covered telecommunications equipment or services as a substantial or essential component of any system, or as critical technology as part of any system, unless the Company is providing (i) a service that connects to the facilities of a third-party, such as backhaul, roaming, or interconnection arrangements; or (ii) telecommunications equipment that cannot route or redirect user data traffic or permit visibility into any user data or packets that such equipment transmits or otherwise handles or the covered telecommunication equipment or services. A waiver, for a period not exceeding August 13, 2021, may be requested.

(2) The Company acknowledges and accepts that the Government is prohibited from entering into an agreement, or extending or renewing an agreement, with an entity that uses any equipment, system, or service that uses covered telecommunications equipment or services as a substantial or essential component of any system, or as critical technology as part of any system, unless an exception at paragraph (b)(1) of this article applies, regardless of whether that use is in performance of work under a Federal contract or agreement.

(c) *Certification.*

The Company shall review the list of excluded parties in the System for Award Management (SAM) (<https://www.sam.gov>) for entities excluded from receiving federal awards for "covered telecommunications equipment or services."

Based on that review:

- (1) The Company certifies that it does **does not** provide covered telecommunications equipment or services as a part of its offered products or services to the Government in the performance of any contract, subcontract, other transaction agreement, or other contractual instrument.
 - (2) If the Company does provide covered telecommunications equipment or services as a part of its offered products or services to the Government in the performance of any contract,
-

subcontract, other transaction agreement, or other contractual instrument as described in paragraph (c)(1), the Company certifies that it will **will not** provide covered telecommunications equipment or services to the Government in the performance of any contract, subcontract, other transaction agreement, or other contractual instrument resulting from this solicitation. If the Company will provide covered telecommunications equipment or services to the Government in the performance of any contract, subcontract, other transaction agreement, or other contractual instrument resulting from this solicitation (c)(2), the Company shall provide the additional disclosure information required at paragraph (d)(1) of this Article.

(3) The Company certifies, after conducting a reasonable inquiry, for purposes of this certification, that it does **does not** use covered telecommunications equipment or services, or use any equipment, system, or service that uses covered telecommunications equipment or services. If the Company does use covered telecommunications equipment or services, or use any equipment, system, or service that uses covered telecommunications equipment or services as described under this paragraph (c)(3), the Company shall provide the additional disclosure information required at paragraph (d)(2) of this Article.

(d) *Disclosures.*

(1) Disclosure for the certification in paragraph (c)(2) of this Article. If the Company does provide covered telecommunications equipment or services to the Government in the performance of any contract, subcontract, other transaction agreement, or other contractual instrument in in paragraph (c)(2) of this provision, the Company shall provide the following information:

(i) For covered equipment—

(A) The entity that produced the covered telecommunications equipment (include entity name, unique entity identifier, CAGE code, and whether the entity was the original equipment manufacturer (OEM) or a distributor, if known);

(B) A description of all covered telecommunications equipment offered (include brand; model number, such as OEM number, manufacturer part number, or wholesaler number; and item description, as applicable); and

(C) Explanation of the proposed use of covered telecommunications equipment and any factors relevant to determining if such use would be permissible under the prohibition in paragraph (b)(1) of this Article.

(ii) For covered services—

(A) If the service is related to item maintenance: A description of all covered telecommunications services offered (include on the item being maintained: Brand; model number, such as OEM number, manufacturer part number, or wholesaler number; and item description, as applicable); or

(B) If not associated with maintenance, the Product Service Code (PSC) of the service being provided; and explanation of the proposed use of covered telecommunications services and any factors relevant to determining if such use would be permissible under the prohibition in paragraph (b)(1) of this Article.

(2) If the Company does use covered telecommunications equipment or services, or use any equipment, system, or service that uses covered telecommunications equipment or services in in paragraph (c)(3) of this Article, the Company shall provide the following information:

(i) For covered equipment—

(A) The entity that produced the covered telecommunications equipment (include entity name, unique entity identifier, CAGE code, and whether the entity was the OEM or a distributor, if known);

(B) A description of all covered telecommunications equipment offered (include brand; model number, such as OEM number, manufacturer part number, or wholesaler number; and item description, as applicable); and



(C) Explanation of the proposed use of covered telecommunications equipment and any factors relevant to determining if such use would be permissible under the prohibition in paragraph (b)(2) of this Article.

(ii) For covered services—

(A) If the service is related to item maintenance: A description of all covered telecommunications services offered (include on the item being maintained: Brand; model number, such as OEM number, manufacturer part number, or wholesaler number; and item description, as applicable); or

(B) If not associated with maintenance, the PSC of the service being provided; and explanation of the proposed use of covered telecommunications services and any factors

relevant to determining if such use would be permissible under the prohibition in paragraph (b)(2) of this Article.

(e) *Reporting requirement.*

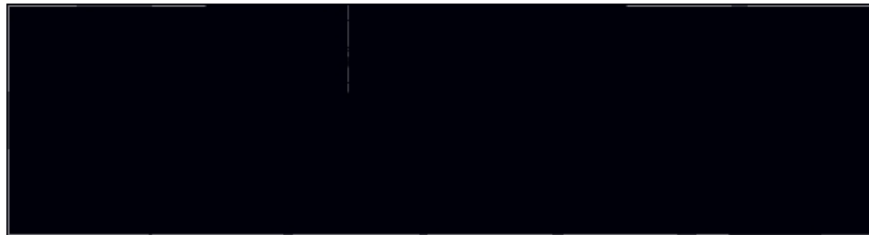
(1) In the event the Company identifies covered telecommunications equipment or services used as a substantial or essential component of any system, or as critical technology as part of any system, during agreement performance, or the Company is notified of such by a subcontractor at any tier or by any other source, the Company shall report the information in paragraph (e)(2) of this Article to the Agreements Officer and to the Department of Defense website at <https://dibnet.dod.mil>.

(2) The Company shall report the following information pursuant to paragraph (e)(1) of this clause

(i) Within one business day from the date of such identification or notification: the agreement number; the order number(s), if applicable; supplier name; supplier unique entity identifier (if known); supplier Commercial and Government Entity (CAGE) code (if known); brand; model number (original equipment manufacturer number, manufacturer part number, or wholesaler number); item description; and any readily available information about mitigation actions undertaken or recommended.

(ii) Within 10 business days of submitting the information in paragraph (e)(2)(i) of this clause: any further available information about mitigation actions undertaken or recommended. In addition, the Company shall describe the efforts it undertook to prevent use or submission of covered telecommunications equipment or services, and any additional efforts that will be incorporated to prevent future use or submission of covered telecommunications equipment or services.

(e) *Subcontracts.* The Company shall insert the substance of this article, including this paragraph but excluding paragraph (b)(2), in all subcontracts and other contractual instruments, including subcontracts for the acquisition of commercial items.



AMENDMENT OF SOLICITATION/MODIFICATION OF CONTRACT			1 CONTRACT ID CODE J	PAGE OF PAGES 1 5
2 AMENDMENT/MODIFICATION NO P00001	3 EFFECTIVE DATE 14-Sep-2021	4 REQUISITION/PURCHASE REQ NO		5 PROJECT NO (If applicable)
6 ISSUED BY DEFENSE INNOVATION UNIT 230 RT JONES RD MOUNTAIN VIEW CA 94043	CODE HQ0845	7 ADMINISTERED BY (If other than item 6) See Item 6		CODE
8. NAME AND ADDRESS OF CONTRACTOR (No., Street, County, State and Zip Code) HOUSTON MECHATRONICS, INC. HMI REGINALD B. BERKA 17146 FEATHERCRAFT LANE, STE 450 WEBSTER TX 77598-4364			9A. AMENDMENT OF SOLICITATION NO.	
CODE 7LK31			9B. DATED (SEE ITEM 11)	
FACILITY CODE			X [REDACTED] CONTRACT/ORDER NO.	
			X 10B. DATED (SEE ITEM 13) 30-Aug-2021	
11. THIS ITEM ONLY APPLIES TO AMENDMENTS OF SOLICITATIONS				
<input type="checkbox"/> The above numbered solicitation is amended as set forth in Item 14. The hour and date specified for receipt of offer <input type="checkbox"/> is extended, <input type="checkbox"/> is not extended Offer must acknowledge receipt of this amendment prior to the hour and date specified in the solicitation or as amended by one of the following methods: (a) By completing Items 8 and 15, and returning _____ copies of the amendment; (b) By acknowledging receipt of this amendment on each copy of the offer submitted; or (c) By separate letter or telegram which includes a reference to the solicitation and amendment numbers. FAILURE OF YOUR ACKNOWLEDGMENT TO BE RECEIVED AT THE PLACE DESIGNATED FOR THE RECEIPT OF OFFERS PRIOR TO THE HOUR AND DATE SPECIFIED MAY RESULT IN REJECTION OF YOUR OFFER. If by virtue of this amendment you desire to change an offer already submitted, such change may be made by telegram or letter, provided each telegram or letter makes reference to the solicitation and this amendment, and is received prior to the opening hour and date specified.				
12. ACCOUNTING AND APPROPRIATION DATA (If required) See Schedule				
13. THIS ITEM APPLIES ONLY TO MODIFICATIONS OF CONTRACT ORDERS. IT MODIFIES THE CONTRACT/ORDER NO. AS DESCRIBED IN ITEM 14.				
A. THIS CHANGE ORDER IS ISSUED PURSUANT TO: (Specify authority) THE CHANGES SET FORTH IN ITEM 14 ARE MADE IN THE CONTRACT ORDER NO. IN ITEM 10A.				
B. THE ABOVE NUMBERED CONTRACT/ORDER IS MODIFIED TO REFLECT THE ADMINISTRATIVE CHANGES (such as changes in paying office, appropriation date, etc.) SET FORTH IN ITEM 14, PURSUANT TO THE AUTHORITY OF FAR 43.103(B).				
C. THIS SUPPLEMENTAL AGREEMENT IS ENTERED INTO PURSUANT TO AUTHORITY OF:				
X D. OTHER (Specify type of modification and authority) Article 4.2, Modifications				
E. IMPORTANT: Contractor <input type="checkbox"/> is not, <input checked="" type="checkbox"/> is required to sign this document and return <u>1</u> copies to the issuing office.				
15A. NAME AND TITLE OF SIGNER (Type or print) Reginald B. Berka, Chief Operating Officer			16A. NAME AND TITLE OF CONTRACTING OFFICER (Type or print) [REDACTED]	
15B. CONTRACTOR/OFFEROR <i>Reginald B. Berka</i> (Signature of person authorized to sign)		15C. DATE SIGNED 15-Sep-2021	[REDACTED]	16C. DATE SIGNED 14-Sep-2021

EXCEPTION TO SF 30
APPROVED BY OIRM 11-84

30-105-04

STANDARD FORM 30 (Rev. 10-83)
Prescribed by GSA
FAR (48 CFR) 53.243

SECTION SF 30 BLOCK 14 CONTINUATION PAGE

SUMMARY OF CHANGES

SECTION A - SOLICITATION/CONTRACT FORM

The total cost of this contract was increased by [REDACTED] from [REDACTED] to [REDACTED].

SECTION B - SUPPLIES OR SERVICES AND PRICES

CLIN 0007

The option status has changed from Option to Option Exercised.

CLIN 0008

The CLIN type priced has been deleted.
The CLIN extended description has changed from:

Critical Design Review

To:

Critical Design Review (CLIN value is [REDACTED])

The pricing detail quantity 1.00 has been deleted.
The unit price amount [REDACTED] has been deleted.
The unit of issue Each has been deleted.
The FOB Destination has been deleted.
The PSC code 1353 has been deleted.
The WSC Equipment code 000 has been deleted.
The NAICS code 334511 has been deleted.
The MDAP/MAIS Code 000 has been deleted.
The total cost of this line item has decreased by [REDACTED] from [REDACTED] to UNDEFINED.

SUBCLIN 0008AA is added as follows:

ITEM NO	SUPPLIES/SERVICES	QUANTITY	UNIT	UNIT PRICE	AMOUNT
0008AA	Technical Documents_ FFP Technical Documents_ FOB: Destination MFR PART NR: 000 1353	1	Each	██████████	██████████
NET AMT					██████████
ACRN AA					██████████
CIN: HQ06421592310008AA					

SUBCLIN 0008AB is added as follows:

ITEM NO	SUPPLIES/SERVICES	QUANTITY	UNIT	UNIT PRICE	AMOUNT
0008AB OPTION	Vendor Host CDR_ FFP Vendor Host CDR_ FOB: Destination MFR PART NR: 000 1353	1	Each	██████████	██████████
NET AMT					██████████

SECTION E - INSPECTION AND ACCEPTANCE

The Acceptance/Inspection Schedule for CLIN 0008 has been changed from:

INSPECT AT Destination	INSPECT BY Government	ACCEPT AT Destination	ACCEPT BY Government
---------------------------	--------------------------	--------------------------	-------------------------

To:

INSPECT AT N/A	INSPECT BY N/A	ACCEPT AT N/A	ACCEPT BY N/A
-------------------	-------------------	------------------	------------------

The following Acceptance/Inspection Schedule was added for SUBCLIN 0008AA:

INSPECT AT Destination	INSPECT BY Government	ACCEPT AT Destination	ACCEPT BY Government
---------------------------	--------------------------	--------------------------	-------------------------

The following Acceptance/Inspection Schedule was added for SUBCLIN 0008AB:

INSPECT AT	INSPECT BY	ACCEPT AT	ACCEPT BY
------------	------------	-----------	-----------



Destination Government Destination Government

SECTION F - DELIVERIES OR PERFORMANCE

The following Delivery Schedule for SUBCLIN 0008AA has been added:

DELIVERY DATE	QUANTITY	SHIP TO ADDRESS	DODAAC / CAGE
12-OCT-2021	1	N/A FOB: Destination	

The following Delivery Schedule for SUBCLIN 0008AB has been added:

DELIVERY DATE	QUANTITY	SHIP TO ADDRESS	DODAAC / CAGE
11-DEC-2021	1	N/A FOB: Destination	

SECTION G - CONTRACT ADMINISTRATION DATA

Accounting and Appropriation

Summary for the Payment Office

As a result of this modification, the total funded amount for this document was increased by [REDACTED] from [REDACTED] to [REDACTED].

CLIN 0007:

[REDACTED] was increased by [REDACTED] from [REDACTED] to [REDACTED].
The contract ACRN AA has been added.
The [REDACTED] has been added.

SUBCLIN 0008AA:

Funding on SUBCLIN 0008AA is initiated as follows:

ACRN: AA

CIN: [REDACTED]

Acctng Data:

[REDACTED]

Increase: [REDACTED]

Total: [REDACTED]

(End of Summary of Changes)



AMENDMENT OF SOLICITATION/MODIFICATION OF CONTRACT			1 CONTRACT ID CODE	PAGE OF PAGES	
2 AMENDMENT/MODIFICATION NO P00002		3 EFFECTIVE DATE 08 Dec 2021	4 REQUISITION/PURCHASE REQ NO		5 PROJECT NO (If applicable)
6 ISSUED BY DEFENSE NOVA ON UN 230 R JONES RD MOUN AN VEW CA 94043		CODE HQ0845	7 ADMINISTERED BY (If other than item 6) See Item 6		
8. NAME AND ADDRESS OF CONTRACTOR (No., Street, County, State and Zip Code) HOUS ON MECHA RON CS NG HM REG NALD B BERKA 17146 FEA HERCRAF LANE S E 450 WEBS ER X 77598-4364			9A. AMENDMENT OF SOLICITATION NO.		
			9B. DATED (SEE ITEM 11)		
			X [REDACTED] CONTRACT/ORDER NO.		
CODE 7LK31			FACILITY CODE		
			X 30 Aug 2021		
11. THIS ITEM ONLY APPLIES TO AMENDMENTS OF SOLICITATIONS					
<input type="checkbox"/> The above numbered solicitation is amended as set forth in Item 14. The hour and date specified for receipt of offer <input type="checkbox"/> is extended, <input type="checkbox"/> is not extended. Offer must acknowledge receipt of this amendment prior to the hour and date specified in the solicitation or as amended by one of the following methods: (a) By completing Items 8 and 15, and returning _____ copies of the amendment; (b) By acknowledging receipt of this amendment on each copy of the offer submitted; or (c) By separate letter or telegram which includes a reference to the solicitation and amendment numbers. FAILURE OF YOUR ACKNOWLEDGMENT TO BE RECEIVED AT THE PLACE DESIGNATED FOR THE RECEIPT OF OFFERS PRIOR TO THE HOUR AND DATE SPECIFIED MAY RESULT IN REJECTION OF YOUR OFFER. If by virtue of this amendment you desire to change an offer already submitted, such change may be made by telegram or letter, provided each telegram or letter makes reference to the solicitation and this amendment, and is received prior to the opening hour and date specified.					
12. ACCOUNTING AND APPROPRIATION DATA (If required)					
13. THIS ITEM APPLIES ONLY TO MODIFICATIONS OF CONTRACTS/ORDERS. IT MODIFIES THE CONTRACT/ORDER NO. AS DESCRIBED IN ITEM 14.					
A. THIS CHANGE ORDER IS ISSUED PURSUANT TO: (Specify authority) THE CHANGES SET FORTH IN ITEM 14 ARE MADE IN THE CONTRACT ORDER NO. IN ITEM 10A.					
B. THE ABOVE NUMBERED CONTRACT/ORDER IS MODIFIED TO REFLECT THE ADMINISTRATIVE CHANGES (such as changes in paying office, appropriation date, etc.) SET FORTH IN ITEM 14, PURSUANT TO THE AUTHORITY OF FAR 43.103(B).					
X C. THIS SUPPLEMENTAL AGREEMENT IS ENTERED INTO PURSUANT TO AUTHORITY OF: Agreement Article III, Paragraph B					
D. OTHER (Specify type of modification and authority)					
E. IMPORTANT: Contractor <input type="checkbox"/> is not, <input checked="" type="checkbox"/> is required to sign this document and return <u>1</u> copies to the issuing office.					
14. DESCRIPTION OF AMENDMENT/MODIFICATION (Organized by UCF section headings, including solicitation/contract subject matter where feasible) Modification Control Number: [REDACTED] The purpose of this modification is to make changes to the Statement of Work and add Article 24: Ensuring Adequate COVID 19 Safety Protocols for Federal Contractors (Dev at on 2021 00009) (OCT 2021) to the agreement terms and conditions. A other Terms and Conditions remain unchanged.					
Except as provided herein, all terms and conditions of the document referenced in Item 9A or 10A, as heretofore changed, remains unchanged and in full force and effect					
15A. NAME AND TITLE OF SIGNER (Type or print)			16A. NAME AND TITLE OF CONTRACTING OFFICER (Type or print)		
[REDACTED]			[REDACTED]		
15B. CONTRACTOR/OFFEROR	15C. DATE SIGNED	16B. [REDACTED]	16C. DATE SIGNED		08 Dec 2021
[REDACTED]	[REDACTED]	[REDACTED]			

SECTION SF 30 BLOCK 14 CONTINUATION PAGE

SUMMARY OF CHANGES

SECTION H - SPECIAL CONTRACT REQUIREMENTS

The following have been modified:

AGREEMENT NO. [REDACTED]

OTHER TRANSACTION FOR PROTOTYPE AGREEMENT

between

The United States Government
Defense Innovation Unit
230 R.T. Jones Rd
Mountain View, CA 94043

and

Houston Mechatronics Inc
17146 Feathercraft Ln Suite 450 Webster, Texas
DUNS Number: 079574594
CAGE: 7LK31

Agreement [REDACTED]

Effective Date: See SF26 Block 3, Agreement

This Agreement is entered into between the United States of America, represented by Defense Innovation Unit, hereinafter called Government and Houston Mechatronics Inc, hereinafter called COMPANY, pursuant to 10 U.S.C.§2371b and under United States Federal law. Government and COMPANY are collectively referred to as the "Parties."

TABLE OF CONTENTS

ARTICLE 1: DEFINITIONS
ARTICLE 2: SCOPE OF THE AGREEMENT
ARTICLE 3: TERM OF THE AGREEMENT AND TERMINATION
ARTICLE 4: MANAGEMENT, ADMINISTRATION, AND MODIFICATION
ARTICLE 5: OBLIGATION AND PAYMENT*
ARTICLE 6: DISPUTES
ARTICLE 7: CONFIDENTIAL INFORMATION
ARTICLE 8: PUBLICATION AND ACADEMIC RIGHTS
ARTICLE 9: PATENT RIGHTS
ARTICLE 10: DATA RIGHTS
ARTICLE 11: SOFTWARE LICENSE
ARTICLE 12: FOREIGN ACCESS TO TECHNOLOGY*
ARTICLE 13: OPERATIONAL SECURITY*
ARTICLE 14: GOVERNING LAW AND JURISDICTION*
ARTICLE 15: TITLE AND DISPOSITION OF PROPERTY
ARTICLE 16: GOVERNMENT FURNISHED PROPERTY
ARTICLE 17: SAFEGUARDING COVERED DEFENSE INFORMATION AND CYBER INCIDENT REPORTING*
ARTICLE 18: STATUTORY AUTHORITY*
ARTICLE 19: INDEMNITY*
ARTICLE 20: ASSIGNMENT AND TRANSFER
ARTICLE 21: FORCE MAJEURE
ARTICLE 22: ORDER OF PRECEDENCE
ARTICLE 23: MISCELLANEOUS
ARTICLE 23: ENSURING ADEQUATE COVID-19 SAFETY PROTOCOLS FOR FEDERAL CONTRACTORS (DEVIATION 2021-O0009) (OCT 2021)

ATTACHMENTS

ATTACHMENT 1: STATEMENT OF WORK
ATTACHMENT 2: WIDE AREA WORKFLOW INSTRUCTIONS
ATTACHMENT 3: AGREEMENT ADMINISTRATION
ATTACHMENT 4: DATA ASSERTIONS LIST
ATTACHMENT 5: COMPANY'S END USER LICENSE AGREEMENT ("EULA")
ATTACHMENT 6: AFFIRMATION OF BUSINESS STATUS CERTIFICATION
ATTACHMENT 7: PROHIBITION ON USE OF CERTAIN TELECOMMUNICATIONS AND VIDEO SURVEILLANCE SERVICES OR EQUIPMENT

ARTICLE 1: DEFINITIONS

- 1.1. "Adequate security" means protective measures that are commensurate with the consequences and probability of loss, misuse, or unauthorized access to, or modification of information.
- 1.2. "Agreement" or "OTA" refers to the Other Transaction Agreement, as authorized under 10 U.S.C. 2371b, between the Government and COMPANY Agreement No. HQ0845-21-9-0031.
- 1.3. "Agreements Officer (AO)" is the Defense Innovation Unit Contracting Activity warranted Contracting Officer authorized to sign the final agreement for the Government.
- 1.4. "Agreements Officer's Representative (AOR)" is the individual designated by the Government on a per project basis to monitor all technical and administrative aspects.
- 1.5. "Commercial Computer Software" means software developed or regularly used for non-governmental purposes which -
- a. Has been sold, leased, or licensed to the public;
 - b. Has been offered for sale, lease, or license to the public;
 - c. Has not been offered, sold, leased, or licensed to the public but will be available for commercial sale, lease, or license in time to satisfy the delivery requirements of this agreement; or
 - d. Satisfies a criterion expressed in paragraphs a, b, or c of this definition and would require only minor modification to meet the requirements of this agreement.
- 1.6. "Commercial Computer Software License" means the license terms under which Commercial Computer Software is sold or offered for sale, lease or license to the general public.
- 1.7. "COMPANY attributional/proprietary information" means information that identifies the COMPANY(s), whether directly or indirectly, by the grouping of information that can be traced back to the COMPANY(s) (e.g., program description, facility locations), personally identifiable information, as well as trade secrets, commercial or financial information, or other commercially sensitive information that is not customarily shared outside of the company.
- 1.8. "Compromise" means disclosure of information to unauthorized persons, or a violation of the security policy of a system, in which unauthorized intentional or unintentional disclosure, modification, destruction, or loss of an object, or the copying of information to unauthorized media may have occurred.
-

1.9. "Computer Data Base" as used in this Agreement, means a collection of data recorded in a form capable of being processed by a computer. The term does not include computer software.

1.10. "Computer program" as used in this Agreement means a set of instructions, rules, or routines in a form that is capable of causing a computer to perform a specific operation or series of operations.

1.11. "Computer software" as used in this Agreement means computer programs, source code, source code listings, object code listings, design details, algorithms, processes, flow charts, formulae and related material that would enable the software to be reproduced, recreated or recompiled. Computer software does not include computer databases or computer software documentation.

1.12. "Computer software documentation" means owner's manuals, user's manuals, installation instructions, operating instructions, and other similar items, regardless of storage medium, that explain the capabilities of the computer software or provide instructions for using the software.

1.13. "Confidential Information" means information and materials of a Disclosing Party which are designated as confidential or as a Trade Secret in writing by such Disclosing Party, whether by letter or by use of an appropriate stamp or legend, prior to or at the same time any such information or materials are disclosed by such Disclosing Party to the Receiving Party. Notwithstanding the foregoing, materials and other information which are orally, visually, or electronically disclosed by a Disclosing Party, or are disclosed in writing without an appropriate letter, stamp, or legend, shall constitute Confidential Information or a Trade Secret if such Disclosing Party, within thirty calendar days after such disclosure, delivers to the Receiving Party a written document or documents describing the material or information and indicating that it is confidential or a Trade Secret, provided that any disclosure of information by the Receiving Party prior to receipt of such notice shall not constitute a breach by the Receiving Party of its obligations. "Confidential Information" includes any information and materials considered a Trade Secret by the COMPANY on its own behalf or on behalf of their subcontractors or suppliers.

1.14. "Contracting Activity" means an element of an agency designated by the agency head and delegated broad authority regarding acquisition functions. It also means elements or another agency designated by the director of a defense agency which has been delegated contracting authority through its agency charter.

1.15. "Controlled technical information" means technical information with military or space application that is subject to controls on the access, use, reproduction, modification, performance, display, release, disclosure, or dissemination. Controlled technical information would meet the criteria, if disseminated, for distribution statements B through F using the criteria set forth in DoD Instruction 5230.24, Distribution Statements on Technical Documents. The term does not include information that is lawfully publicly available without restrictions.

1.16. "Covered COMPANY information system" means an unclassified information system that is owned, or operated by or for, a COMPANY and that processes, stores, or transmits covered defense information.

1.17. "Covered defense information" means unclassified controlled technical information or other information, as described in the Controlled Unclassified Information (CUI) Registry at <http://www.archives.gov/cui/registry/category-list.html>, that requires safeguarding or dissemination controls pursuant to and consistent with law, regulations, and Government wide policies, and is—

- a. Marked or otherwise identified in the agreement, task order, or delivery order and provided to the COMPANY by or on behalf of DoD in support of the performance of the agreement; or
-

b. Collected, developed, received, transmitted, used, or stored by or on behalf of the COMPANY in support of the performance of the Agreement.

1.18. "Cyber incident" means actions taken through the use of computer networks that result in a compromise or an actual or potentially adverse effect on an information system and/or the information residing therein.

1.19. "Data" means recorded information, regardless of form or the media on which it may be recorded. The term includes technical data and computer software. The term does not include information incidental to agreement administration, such as financial, administrative, cost or pricing, or management information.

1.20. "Date of Completion" is the date on which all work is completed or the date on which the period of performance ends.

1.21. "Developed" means that an item, component, or process exists and is workable. Thus, the item or component must have been constructed or the process practiced. Workability is generally established when the item, component, or process has been analyzed or tested sufficiently to demonstrate to reasonable people skilled in the applicable art that there is a high probability that it will operate as intended. Whether, how much, and what type of analysis or testing is required to establish workability depends on the nature of the item, component, or process, and the state of the art. To be considered "developed," the item, component, or process need not be at the stage where it could be offered for sale or sold on the commercial market, nor must the item, component, or process be actually reduced to practice within the meaning of Title 35 of the United States Code.

1.22. "Development" means the systematic use of scientific and technical knowledge in the design, development, testing, or evaluation of a potential new product or service (or of an improvement in an existing product or service) to meet specific performance requirements or objectives. It includes the functions of design engineering, prototyping, and engineering testing.

1.23. "Disclosing Party" means COMPANY, or their subcontractors or suppliers, or the Government who discloses Confidential Information.

1.24. "Form, fit and function data" means technical data that describes the required overall physical, functional and performance characteristics (along with the qualification requirements, if applicable) of an item, component, or process to the extent necessary to permit identification of physically and functionally interchangeable items.

1.25. "Foreign Firm or Institution" means a firm or institution organized or existing under the laws of a country other than the United States, its territories, or possessions. The term includes, for purposes of this Agreement, any agency or instrumentality of a foreign government; and firms, institutions or business organizations which are owned or substantially controlled by foreign governments, firms, institutions, or individuals.

1.26. "Forensic analysis" means the practice of gathering, retaining, and analyzing computer-related data for investigative purposes in a manner that maintains the integrity of the data.

1.27. "Government" means the U.S. Government.

1.28. "Government Fiscal Year" means the period commencing on October 1 and ending September 30 of the following calendar year.

1.29. "Information system" means a discrete set of information resources organized for the collection, processing, maintenance, use, sharing, dissemination, or disposition of information.

1.30. "Know-How" means all information including, but not limited to discoveries, formulas, materials, inventions, processes, ideas, approaches, concepts, techniques, methods, software, programs, documentation, procedures, firmware, hardware, technical data, specifications, devices, apparatus and machines.

1.31. "Malicious software" means computer software or firmware intended to perform an unauthorized process that will have adverse impact on the confidentiality, integrity, or availability of an information system. This definition includes a virus, worm, Trojan horse, or other code-based entity that infects a host, as well as spyware and some forms of adware.

1.32. "Media" means physical devices or writing surfaces including, but is not limited to, magnetic tapes, optical disks, magnetic disks, large-scale integration memory chips, and printouts onto which covered defense information is recorded, stored, or printed within a covered COMPANY information system.

1.33. "Milestone" means a scheduled event signifying the completion of a major deliverable or a set of related deliverables as identified in the Statement of Work.

1.34. "Operationally critical support" means supplies or services designated by the Government as critical for airlift, sealift, intermodal transportation services, or logistical support that is essential to the mobilization, deployment, or sustainment of the Armed Forces in a contingency operation.

1.35. "Receiving Party" means COMPANY, or their subcontractors or suppliers, or the Government who receives Confidential Information disclosed by a Disclosing Party.

1.36. "Signatory Authority" refers to the individual that has the authority to legally bind a party to an agreement.

1.37. "Subject Invention" means any invention or discovery of the Government or Company, individually or jointly, that is conceived or first actually reduced to practice in the course of or under this agreement, and includes any art, method, process, machine, manufacture, design, or composition of matter, or any new and useful improvement thereof, whether patented or unpatented under the Patent Laws of the United States or any foreign country.

1.38. "Technical information" means technical data or computer software, examples of technical information include research and engineering data, engineering drawings, and associated lists, specifications, standards, process sheets, manuals, technical reports, technical orders, catalog-item identifications, data sets, studies and analyses and related information, and computer software executable code and source code.

1.39. "Trade Secret" means all forms and types of financial, business, scientific, technical, economic, or engineering or otherwise proprietary information, including, but not limited to, patterns, plans, compilations, program devices, formulas, designs, prototypes, methods, techniques, processes, procedures, programs, or codes, whether tangible or intangible, and whether or how stored, compiled, or memorialized physically, electronically, graphically, photographically, or in writing if:

- a. The owner thereof has taken reasonable measures to keep such information secret; and
-

b. The information derives independent economic value, actual or potential, from not being generally known to, and not being readily ascertainable through proper means by, the public.

1.40. "Technology" means discoveries, innovations, Know-How and inventions, whether patentable or not, including computer software, recognized under U.S. law as intellectual creations to which rights of ownership accrue, including, but not limited to, patents, trade secrets, mask works, and copyrights developed under this Agreement.

1.41. "Controlled Unclassified Information (CUI)" means unclassified information that requires safeguarding or dissemination controls, pursuant to and consistent with applicable law, regulations, and Government-wide policies. Instructions for the use, marking, dissemination, and storage of CUI can be found in DoD Instruction 5200.48, "Controlled Unclassified Information (CUI)."

ARTICLE 2: SCOPE OF THE AGREEMENT

2.1. Background

Other Transactions Agreement (OTA) is the term commonly used to refer to the 10 USC 2371b authority to enter into transactions other than contracts, grants or cooperative agreements. The Department of Defense (DoD) currently has authority to make awards that are directly relevant to enhancing the mission effectiveness of military personnel and the supporting platforms, systems, components, or materials proposed to be acquired or developed by the Department of Defense, or to improvement of platforms, systems, components, or materials in use by the armed forces. OTAs are acquisition instruments that are generally not subject to the Federal laws and regulations governing procurement (FAR based) contracts. As such, they are not required to comply with the Federal Acquisition Regulation (FAR), its supplements (e.g., DFARS) or laws that are limited in applicability to procurement contracts. This OTA is awarded in accordance with Commercial Solutions Opening (CSO) HQ0845-20-S-C001 procedures, posted Area of Interest, and is the result of a competitive process based on the COMPANY's submitted proposals.

2.2. Scope

2.2.1. This Agreement is an Other Transaction Agreement pursuant to 10 U.S.C. § 2371b. The principal purpose of this Agreement is to conduct a prototype project per Attachment 1: Statement of Work (SOW).

2.2.2. COMPANY shall be responsible for performance of the work set forth in the SOW. The COMPANY shall provide all documentation required in accordance with the deliverables table set forth in the SOW.

2.2.3. The COMPANY shall be paid a fixed amount for each milestone accomplished in accordance with the Schedule of Milestones and Payments set forth in Attachment 2: Wide Area Workflow Instructions and Article 5 procedures.

2.3. Potential for Follow-On Production

2.3.1. 10 U.S.C. Section § 2371b authorizes DoD to structure OT agreements with potential to award a follow-on, sole source production contract or transaction to the OT agreement participants. Two criteria

must be met to use this authority; 1) competitive procedures were used to select the COMPANY and 2) the participants must have successfully completed the prototype project provided for in the transaction. This award leveraged competitive procedures outlined in accordance with the Area of Interest under the solicitation vehicle represented in Article 2.1. This meets the first criterion needed to use the follow-on authority provided under title 10 U.S.C. § 2371b.

2.3.2. In accordance with 10 U.S.C. § 2371b the parties will consider this agreement or portions thereof successfully completed upon acceptance of specific: milestones, objectives, outcomes, or accomplishments as outlined in the SOW. In accordance with OSD policy, successful completion may occur prior to the completion of the entire prototype project. Additionally, completion can occur prior to the conclusion of a prototype project to allow the Government to transition any aspect of the prototype project determined to provide utility into production while other aspects of the prototype project have yet to be completed.

ARTICLE 3: TERM OF AGREEMENT AND TERMINATION

3.1. Term of this Agreement

The term of this agreement commences upon the effective date and continues as defined in the Statement of Work. Provisions of this Agreement, which, by their express terms or by necessary implication, apply for periods of time other than specified herein, shall be given effect, notwithstanding this Article.

3.2. Termination Provisions

The Government may terminate this Agreement by written notice to the COMPANY, provided that such written notice is preceded by consultation between the Parties. The COMPANY may request Agreement termination by giving the Government written notification with sufficient notice of their intent to do so. Failure of the Parties to agree to terminate shall be resolved pursuant to Article 6, Disputes.

3.3. Extending the Term


The Parties may extend, by mutual written agreement, the term of this Agreement if opportunities within the scope set forth in Article 2 reasonably warrant. Any extension shall be formalized through modification of the Agreement by the Agreements Officer and the COMPANY and in accordance with procedures outlined in Article 4.2.

3.4. Special Termination Clause

In the event the Government is made aware of an "outside investor" in violation of the Committee on Foreign Investment in the United States (CFIUS) or The Foreign Investment Risk Review Modernization Act of 2018 (FIRRMA), this Agreement will be subject to immediate termination without notification pursuant to Article 3.2. The COMPANY is encouraged to disclose outside investor activity in order for the Government to perform risk assessment of critical technology and national defense.

ARTICLE 4: MANAGEMENT, ADMINISTRATION, AND MODIFICATION

4.1. Administration. Unless otherwise provided in this Agreement, changes to this Agreement may only be made by the Agreements Officer. Administrative and contractual matters under this Agreement shall be referred to the representatives identified in Attachment 3: Agreement Administration.



4.2. Modifications

4.2.1. Recommendations for modifications, including justifications to support any changes to the SOW and terms of this agreement may originate with either a request from the COMPANY to the AOR and Agreements Officer, or the Government through the Agreements Officer. This documentation will detail the technical, chronological, and financial impact of the proposed modification to the program. The AO and the COMPANY shall approve any Agreement modification. The Government is not obligated to pay for additional or revised future milestones until the Milestone Payment chart in the SOW is formally revised and made part of this Agreement via a modification signed by the Agreements Officer.

4.2.2. The Agreements Officer is responsible for the review and approval of any recommendations to modify the SOW, or other proposed changes to the terms and conditions of this Agreement. If additional terms and conditions are required to be included to address work that may be required under this Agreement, they will be included by mutual written modification to this Agreement.

4.3.3. For minor or administrative Agreement modifications (e.g. changes in the paying office or appropriation data, changes to Government or the Company's personnel identified in the Agreement) no signature is required by the Company. Administrative modifications may be unilaterally executed by the Agreements Officer. All modifications except for administrative modifications shall be made by mutual written agreement of the parties.

4.3.4. The Agreements Officer is responsible for initiating all modifications to this Agreement.

ARTICLE 5: OBLIGATION AND PAYMENT

5.1. Obligation

This Agreement is funded in accordance with the amount annotated in the SF 26 Section G. In no case shall the Government's financial obligations exceed the amount obligated on the Agreement or by amendment to this Agreement. The Government is not obligated to reimburse the COMPANY for expenditures in excess of the amount of obligated funds allotted by the Government. If a modification becomes necessary in performance of this Agreement, pursuant to Article 4.2, the Agreements Officer and the COMPANY shall execute a revised Schedule of Milestones and Payments for prospective milestones.

5.2. Payments

5.2.1. The Parties agree that payments will be made in accordance with completion of milestones. These payments reflect value received by the Government toward the accomplishment of the prototype project goals of this Agreement.

5.2.2. The COMPANY shall document the accomplishments of each completed milestone by submitting or otherwise providing the Milestone Report required by the SOW. After verification (written or otherwise) of the accomplishment of the milestone by the AOR, the COMPANY will submit their invoice through Wide Area Workflow (WAWF), as detailed in Attachment 2.

5.2.3. Limitation of Funds: In no case shall the Government's financial liability exceed the amount obligated under this Agreement.

5.2.4. Payments will be made by the cognizant Defense Finance and Accounting Service office, as indicated in Attachment 2, within thirty (30) calendar days of an accepted invoice in WAWF. Attachment 2 details how to submit and process invoices through WAWF.

5.2.5. Payments shall be made in the amounts set forth in SF26 Section B, provided the AOR has verified the completion of the milestones.

5.2.6. The COMPANY shall maintain adequate records to account for all funding under this Agreement.

5.3. Financial Records and Reports:

5.3.1. The COMPANY shall maintain adequate records to account for Federal funds received under this Agreement and shall maintain adequate records to account for COMPANY Project Agreement funding provided under this Agreement. COMPANY relevant financial records are subject to examination or audit by or on behalf of the Comptroller General, DIU Contracting Activity, or other Government Official for a period not to exceed three years after expiration of the term of the Agreement. The Comptroller General, Agreements Officer or designee shall have direct access to sufficient records and information of any party to this agreement or any entity that participates in the performance of this agreement to ensure full accountability for all funding under this Agreement. Such audit, examination or access shall be performed during business hours on business days upon prior written notice and shall be subject to the security requirements of the audited party. Any audit required during the course of the program may be conducted by the Comptroller General or other Government Official using Government auditors or, at the request of COMPANY's external CPA accounting firm at the expense of the COMPANY. This requirement shall not apply with respect to a party or entity, or a subordinate element of a party or entity, that has not entered into any other agreement that provides for audit access by a Government entity in the year prior to the date of the agreement.

5.3.2. The COMPANY shall include this Article, suitably modified to identify the Parties, in all subcontracts or lower tier agreements entered into solely in connection with this Agreement.

ARTICLE 6: DISPUTES

6.1. General

The Parties shall communicate with one another in good faith and in a timely and cooperative manner when raising issues pertaining to this Agreement under this article, with the objective of resolving any misunderstanding, disagreement, claims, or disputes by mutual agreement.

6.2. Dispute Resolution Procedures

6.2.1. Any disagreement, claim or dispute between the Government and the COMPANY concerning questions of fact or law arising from or in connection with this Agreement, and, whether or not involving an alleged breach of this Agreement, may be raised only under this Article.

6.2.2. Whenever disputes, disagreements, or misunderstandings arise, the Parties shall attempt to resolve the issue(s) involved by discussion and mutual agreement as soon as practicable, with the goal of settlement within three (3) months of identification of the issue. Every reasonable attempt will be made to resolve all issues at the Agreements Officer's level. Alternative Dispute Resolution (ADR) procedures to include, but not limited to settlement negotiations, mediation and fact-finding, will be used to the maximum extent practicable. Whenever the COMPANY submits, in writing, a claim or issue to the Government, the

Agreements Officer shall consider the claim or issue and, within 30 calendar days of receipt of the claim or issue in dispute, either:

- a. Prepare and transmit a written decision to the COMPANY, which shall include the basis for the decision, and accordingly document the Agreement file or;
- b. Notify the COMPANY of a specific date when the Agreements Officer will render a decision if more time is needed for response. The notice will inform the COMPANY of the reason for delaying the decision.

6.2.3. In the event the COMPANY decides to appeal the decision, the Agreements Officer shall make every effort to encourage the COMPANY to enter into ADR procedures with the Agreements Officer. The ADR procedure applicable to this Agreement expressed in subparagraphs below:

- a. Failing resolution by mutual agreement, the aggrieved Party shall document the dispute, disagreement, or misunderstanding by notifying the other Party through the cognizant Agreements Officer in writing documenting the relevant facts, identifying unresolved issues, specifying the clarification or remedy sought, and documenting the rationale as to why the clarification/remedy is appropriate. Within ten (10) working days after providing notice to the other Party, the aggrieved Party may, in writing, request a decision by the Senior Contracting Official, DIU. The other Party shall submit a written position on the matter(s) in dispute within thirty (30) calendar days after being notified that a decision has been requested. The Senior Contracting Official, DIU, will conduct a review of the matter(s) in dispute and render a decision in writing within thirty (30) calendar days of receipt of such position. Any such decision is final and binding, unless a Party shall, within thirty (30) calendar days request further review as provided by this article. If requested within thirty (30) calendar days of the decision by the Senior Contracting Official, DIU, further review will be conducted by the President of the COMPANY and the DIU Director. In the event of a decision, or in absence of a decision within sixty (60) calendar days of referral to the President of the COMPANY and the DIU Director (or such other period as agreed to by the parties), either party may pursue any right or remedy provided by law. Alternatively, the parties may agree to explore and establish an Alternate Disputes Resolution procedure to resolve this dispute.
- b. If the COMPANY chooses not to participate in the Dispute Resolution Procedure or does not accept the results of the Dispute Resolution Procedure, the COMPANY may bring a formal claim as authorized by 28 U.S.C. 1491 or other applicable statutes, and pursue any right and remedy in a court of competent jurisdiction. The Parties' attempt to resolve issues through settlement negotiations, mediation and fact-finding pursuant to this Article 6 shall be non-binding and without prejudice to either Party.

6.3. Limitation of Damages

Claims for damages of any nature whatsoever pursued under this Agreement shall be limited to direct damages only up to the aggregate amount of Government funding disbursed as of the time the dispute arises. In no event shall the Government be liable for claims for consequential, punitive, special and incidental damages, claims for lost profits, or other indirect damages.

ARTICLE 7: CONFIDENTIAL INFORMATION

7.1. Exchange of Information

[REDACTED]

The Government may from time to time disclose Government Confidential Information to the COMPANY and its subcontractors or suppliers, in connection with a particular project, and the COMPANY and its subcontractors or suppliers, may from time to time disclose information that is Trade Secret or Confidential Information to the Government in connection with the OTA or performance thereunder. Neither the Government nor COMPANY or their subcontractors or suppliers shall be obligated to transfer Confidential Information or Trade Secrets independently developed by the Government or the COMPANY or their subcontractors or suppliers, absent an express written agreement between the Parties providing the terms and conditions for such disclosure.

7.2. Confidentiality and Authorized Disclosure

The Receiving Party agrees, to the extent permitted by law, that Confidential Information and Trade Secrets shall remain the property of the Disclosing Party (no one shall disclose unless they have the right to do so), and that, unless otherwise agreed to by the Disclosing Party, Confidential Information and Trade Secrets shall not be disclosed, divulged, or otherwise communicated by it to third parties or used by it for any purposes other than in connection with specified project efforts and the licenses granted in Article 8, Article 9, and Article 10, provided that the duty to protect such "Confidential Information" and "Trade Secrets" shall not extend to materials or information that:

1. Are received or become available without restriction to the Receiving Party under a proper, separate agreement,
2. Are not identified with a suitable notice or legend per Article entitled "Confidential Information" herein,
3. Are lawfully in possession of the Receiving Party without such restriction to the Receiving Party at the time of disclosure thereof as demonstrated by prior written records,
4. Are or later become part of the public domain through no fault of the Receiving Party,
5. Are received by the Receiving Party from a third party having no obligation of confidentiality to the Disclosing Party that made the disclosure,
6. Are developed independently by the Receiving Party without use of Confidential Information or Trade Secrets as evidenced by written records,
7. Are required by law or regulation to be disclosed; provided, however, that the Receiving Party has provided written notice to the Disclosing Party promptly so as to enable such Disclosing Party to seek a protective order or otherwise prevent disclosure of such information.

7.3. Return of Proprietary Information

Upon the request of COMPANY, the Government shall promptly return all copies and other tangible manifestations of the Confidential Information or Trade Secrets disclosed. Upon request by the Government, COMPANY shall promptly return all copies and other tangible manifestations of the Confidential Information disclosed by the Government. As used in this section, tangible manifestations include human readable media as well as magnetic and digital storage media.

7.4. Term

██████████

Except to the extent covered by and subject to other provisions of this Agreement, the obligations of the Receiving Party under this Article shall continue for a period of five (5) years after the expiration or termination of this Agreement.

7.5. Subcontracts

The Government and the COMPANY shall flow down the requirements of this Article to their respective personnel, agents, partners, and team members receiving such Confidential Information or Trade Secrets under this OTA.

ARTICLE 8: PUBLICATION AND ACADEMIC RIGHTS

8.1. Use of Information

Subject to the provisions of Article 7, Confidential Information, and this Article, Publication and Academic Rights, the COMPANY and the Government shall have the right to publish or otherwise disclose information and/or data developed by the Government and/or the respective COMPANY under this Agreement. The COMPANY and the Government (and its employees) shall include an appropriate acknowledgement of the sponsorship of the Research Projects by the Government and the COMPANY in such publication or disclosure. The Parties shall have only the right to use, disclose, and exploit any such data and Confidential Information or Trade Secrets in accordance with the rights held by them pursuant to this Agreement. Notwithstanding the above, the Parties shall not be deemed authorized by Article 8.1, alone, to disclose any Confidential Information or Trade Secrets of the Government or the COMPANY. Nothing contained herein shall contradict or contravene any use of unlimited data rights obtained under Article 10 below.

8.2. Classified Research Projects

If a release of Confidential Information or Trade Secrets is for a classified Research Project, the provisions of the DoD Security Agreement (DD Form 441), Certificate Pertaining to Foreign Interests (SF 328), and the DoD Contract Security Classification Specification (DD Form 254) apply. The Government will be responsible for the completion of the DD Form 254. The COMPANY member must complete the DD Form 441 and SF 328 and provide them to the Government through for review by the proper Government representatives, the Industrial Security Representative at the cognizant Defense Security Service (DSS) office for DD Form 441 and SF 328 and the requiring activity's local Security office for the DD Form 254.

8.3. Review or Approval of Technical Information for Public Release

8.3.1. At least 30 days prior to the scheduled release date, COMPANY shall submit to the Agreements Officer two copies of the information to be released. The Agreements Officer will route the information to the AOR and other appropriate parties for review and approval.

8.3.2. The AOR is hereby designated as the approval authority for the Agreements Officer for such releases.

8.3.3. Parties to this Agreement are responsible for ensuring that an acknowledgment of government support will appear in any publication of any material based on or developed under this OTA, using the following acknowledgement terms:

"Effort sponsored by the U.S. Government under Other Transaction number ██████████ between the COMPANY and the Government. The U.S. Government is authorized to reproduce and distribute reprints for Governmental purposes notwithstanding any copyright notation thereon."

8.3.4. Parties to this Agreement are also responsible for assuring that every publication of material based on or developed under this project contains the following disclaimer:

"The views and conclusions contained herein are those of the authors and should not be interpreted as necessarily representing the official policies or endorsements, either expressed or implied, of the U.S. Government."

8.3.5. The COMPANY shall flow down these requirements to its partners and team members, at all tiers.

8.4. Filing of Patent Applications

During the course of any such thirty (30) calendar day period, the COMPANY and/or the Government shall provide notice to the Agreements Officer as to whether it desires that a patent application be filed on any invention disclosed in such materials. In the event that a COMPANY and/or the Government desires that such a patent be filed, the COMPANY or the Government proposing to publish or disclose such materials agrees to withhold publication and disclosure of such materials until the occurrence of the first of the following:

1. Filing of a patent application covering such invention, or
2. Written agreement, from the Agreements Officer and the COMPANY that no patentable invention is disclosed in such materials.
3. Further, during the course of any such thirty (30) calendar day period, the COMPANY shall notify the Agreements Officer and the Government if it believes any of its Confidential Information or Trade Secrets have been included in the proposed publication or disclosure and shall identify the specific Confidential Information or Trade Secrets that need to be removed from such proposed publication. The Government and the COMPANY agree to remove from the proposed publication or disclosure all such Confidential Information or Trade Secrets so identified by the COMPANY.

ARTICLE 9: PATENT RIGHTS

9.1. Allocation of Principal Rights

9.1.1. Unless the COMPANY notifies the Government, in accordance with subparagraph 2 below, that the COMPANY does not intend to retain title, the COMPANY shall retain the entire right, title, and interest throughout the world to each Subject Invention consistent with the provisions of this Article.

9.1.2. With respect to any Subject Invention in which the COMPANY retains title, the Government shall receive a nonexclusive, nontransferable, irrevocable, paid-up license to practice, or to have practiced (make, have made, use, have used, or import) the Subject Invention throughout the world on behalf of the United States for U.S. Government purposes and on behalf of any foreign government or international organization pursuant to any existing or future treaty or agreement with the United States in accordance with 35 U.S.C. § 209(d)(1) and 37 C.F.R. 404.7(a)(2)(i). The COMPANY shall record a confirmatory instrument of the Government's license to the Subject Invention with the United States Patent and Trademark Office.

9.1.3. In accordance with 37 C.F.R. 404.7(a)(2)(ii), the Government retains the right to grant licenses to third parties on reasonable terms when necessary to fulfill health, safety, or other needs of the public to the extent such needs are not being reasonably satisfied by COMPANY.

9.2. EULA Considerations

All Data delivered to the Government under this Agreement, other than Data Developed or Generated under this Agreement, shall be subject to the restrictions and limitations set forth in COMPANY's End User License Agreement ("EULA") at Attachment 5 (if applicable) provided they are consistent with federal law. To the extent the terms and conditions in the COMPANY's EULA, including all subcontractor EULAs, are inconsistent with federal law, they shall be deemed deleted and unenforceable including, but not limited to the following:

1. Any future changes to this Agreement or the EULA must be signed by a duly warranted Agreements Officer, in writing. The same requirement applies to contract modifications affecting the rights of the parties. All terms and conditions intended to bind the Government must be included within the contract signed by a warranted Agreements Officer.
2. Clauses in the EULA referencing termination or cancellation are hereby deemed to be deleted. Termination and cancellations will be governed by Article 3 of this Agreement.
3. Any disputes relating to the EULA shall be resolved in accordance with Article 6 of this Agreement. Any provisions of the EULA that would subject the United States to any law, jurisdiction, or venue other than that of the United States is hereby deemed to be deleted. The validity, interpretation and enforcement of this Agreement and the attached EULA will be governed by and construed in accordance with federal law as opposed to any state or local law.
4. All EULA clauses referencing Licensee Indemnities are hereby deemed to be deleted. All EULA clauses that (1) violate the Department of Justice's right to represent the Government in any case (28 U.S.C. § 516) and/or (2) require that the Government give sole control over the litigation and/or settlement, are hereby deemed to be deleted.
5. All EULA clauses that violate the Anti-Deficiency Act (31 U.S.C. § 1341), which prohibits the Government from paying any fees or penalties beyond the Agreement amount (including attorney's and expert witness fees), unless specifically authorized by existing statutes, are hereby deemed to be deleted. This includes, but is not limited to, provisions indicating paid services, fees, charges, and/or billing practices will renew automatically until the licensee elects to cancel.
6. COMPANY's warranty clause shall not impair the U.S. Government's right to recover for fraud or crimes arising out of or related to this Agreement under any federal fraud statute, including, but not limited, to the False Claims Act, 31 U.S.C. §§ 3729-3733.
7. The EULA does not represent the entire agreement, but will be incorporated as an attachment and made a material part of the Agreement.

9.3. Marking of Data

Pursuant to Article 9.1 and Article 1 any Data delivered under this Agreement, except for Data subject to COMPANY's EULA pursuant to Article 9.2, above, shall be marked with the appropriate data rights markings and the COMPANY's name and address and include the following legend:

"Use, duplication, or disclosure is subject to the restrictions as stated in Agreement [REDACTED] between the Government and the COMPANY."

██████████

9.4. Lower Tier Agreements

The COMPANY shall include this Article, suitably modified to identify the Parties, in all subcontracts or lower tier agreements entered into solely in connection with this Agreement.

ARTICLE 10: DATA RIGHTS

10.1. Allocation of Principal Rights

10.1.1. Data that will be delivered, furnished, or otherwise provided to the Government under this Agreement, in which the Government has previously obtained rights, shall be delivered, furnished, or provided with the pre-existing rights, unless (a) the parties have agreed otherwise, or (b) any restrictions on the Government's rights to use, modify, reproduce, release, perform, display, or disclose the data have expired or no longer apply.

10.1.2. Identification of Principal Rights: See Attachment 4.

10.1.3. Marking of Data: Any Data delivered under this Agreement shall be marked with the following legend:

"This data is being delivered as Commercial Computer Software or Technical Data, as defined in Agreement ██████████. Use, duplication, or disclosure is subject to the restrictions as stated in ██████████ between the COMPANY and the Government."

10.1.4. In the event that the COMPANY learns of a release to the Government of its unmarked Data that should have contained a restricted legend, the COMPANY will have the opportunity to cure such omission going forward by providing written notice to the Agreements Officer within six (6) months of the erroneous release.

10.2. Prior Technology

In the event it is necessary for the COMPANY to furnish the Government with Data which existed prior to, or was produced outside of this Agreement, and such Data embodies trade secrets or comprises commercial or financial information which is privileged or confidential, and such Data is so identified with a suitable notice or legend, the Data will be maintained in confidence and disclosed and used by the Government and such Government Contractors or contract employees that the Government may hire on a temporary or periodic basis only for the purpose of carrying out the Government's responsibilities under this Agreement. Data protection will include proprietary markings and handling, and the signing of nondisclosure agreements by such Government Contractors or contract employees. The COMPANY shall not be obligated to provide Data that existed prior to, or was developed outside of this Agreement to the Government. Upon completion of activities under this Agreement, such Data will be disposed of as requested by the COMPANY.

10.3. Oral and Visual Information

If information which the COMPANY considers to embody trade secrets or to comprise commercial or financial information which is privileged or confidential is expressly disclosed orally or visually directly to the Government, the exchange of such information must be memorialized in tangible, recorded form and marked with a suitable notice or legend, and furnished to the Government within thirty (30) calendar

days after such oral or visual disclosure, or the Government shall have no duty to limit or restrict, and shall not incur any liability for any disclosure and use of such information. If the Government reasonably determines that the memorialization of the exchange is insufficiently detailed to enable it to identify the privileged or confidential information, COMPANY shall provide additional detail at the Government's request, subject to restrictions on use and disclosure.

10.4. Disclaimer of Liability

10.4.1. Notwithstanding the above, the Government shall not be restricted in, nor incur any liability for, the disclosure and use of:

- a. Data not identified with a suitable notice or legend as set forth in this Article; nor
- b. Information contained in any Data for which disclosure and use is restricted, if such information is or becomes generally known without breach of the above, is properly known to the Government or is generated by the Government independent of carrying out responsibilities under this Agreement, is rightfully received from a third party without restriction, or is included in Data which the COMPANY has furnished, or is required to furnish to the Government without restriction on disclosure and use.

10.4.2. Notwithstanding Article 10.4.1.a., if the COMPANY cures the omission of the suitable notice or legend, the restrictions, and related liability for disclosure and use of such information shall apply after cure unless it is then unrestricted under Article 10.4.1.b.

10.5. Copyright

The COMPANY hereby grants to the U.S. Government a non-exclusive, non-transferable, royalty-free, fully paid-up license to reproduce, prepare derivative works, distribute copies to the public, and perform publicly and display publicly any copyrighted materials developed (excluding Data) under this Agreement to which it owns the copyright, and to authorize others to do so.

10.6. Lower Tier Agreements

The COMPANY shall include this Article, suitably modified to identify the parties, in all, subcontracts or lower tier agreements, regardless of tier, or experimental, developmental, or research work.

10.7. Survival Rights

Provisions of this Article shall survive termination of this Agreement.

ARTICLE 11: SOFTWARE LICENSE

11.1. License and Restrictions

11.1.1. Subject to the terms and conditions of this Agreement, the COMPANY grants to the Government, a non-sublicensable, nonexclusive license (the "License") to the Products set forth in this OTA during the term of the License Term in each Order placed under this Agreement. The Government may allow access

to the Products to Government Authorized Users. Under the License, the COMPANY grants the Government the right to permit Government Authorized Users to access the Products and where applicable, Reports, through the applicable interfaces.

11.1.2. License to Documentation. Subject to Article 7 (Confidential Information) and Article 10 (Data Rights), the Government may make and distribute copies of the Documentation for use solely by Government Authorized Users in connection with use of the Products in accordance with this Agreement, but no more than the amount reasonably necessary. Any permitted copy of the Documentation must contain the same copyright and other proprietary notices that appear in the Documentation.

11.1.3. License Restrictions. Except for the rights expressly granted under this Agreement, the Government shall not:

- a. use the Products in (A) violation of any applicable law (including, where applicable, Children's Online Privacy Protection Act (COPPA)), or in connection with unlawful material (such as material that violates any obscenity, defamation, harassment, privacy, or intellectual property laws); or (B) a manner that would cause a material risk to the security or operations of COMPANY or any of its customers, or to the continued normal operation of other COMPANY customers;
- b. republish, display, sell, rent, lease, host, circulate, disseminate, assign or sub-license the Products;
- c. offer, use, or permit the use of the Products in a computer service business, third-party outsourcing service, on a membership or subscription basis, on a service bureau basis, on a time-sharing basis, as part of a hosted service, or on behalf of any third party;
- d. attempt to interact with the operating system underlying the Products, or modify, create derivative works of, adapt, translate, reverse engineer, decompile, or otherwise attempt to discover the source code in, any COMPANY technical data. This restriction will not apply to the extent it limits any non-waivable right Government may enjoy under applicable law;
- e. remove, obscure, or alter any proprietary notices associated with the Products (including any notices in reports that are deliverables under this Agreement);
- f. use any software components, modules, or other services that may be delivered with the Products, but which are not licensed to Government; or
- g. unbundle any components of the Products for use on different computers or devices as the Products are designed and provided to Government for use as single non-severable offerings. The COMPANY reserves all other rights not expressly granted in this Agreement.

11.2. Security and Support

The COMPANY shall:

1. not use, modify or disclose to anyone any electronic data or information submitted by the Government to or through the Products or specific identifiable information on the Government's use of the Products ("Government Data"), except as reasonably required to provide the Products to the Government;
 2. provide the Government with support for the Products in accordance with the COMPANY's then-current standard support policies and all support requirements required under this OTA. The
-

COMPANY may from time to time at its sole discretion modify, update, upgrade or extend the Products (including, without limitation, for the purposes of adding features and functionality, or enhancing security or usability).

11.3. Third Party Access

11.3.1. Subject to Article 7 (Confidential Information) and Article 10 (Data Rights) above, the Government may allow a third-party covered Government support contractor to operate, use or access the data/Products solely on Government's behalf. The COMPANY may require the Government support contractor to enter into a non-disclosure agreement directly with the COMPANY regarding the Government support contractor's operation, use or access of such data/Products, or alternatively, that the COMPANY (or party asserting restrictions) may waive in writing the requirement for a nondisclosure agreement.

11.3.1.1 Anticipated Government support contractors assisting in this effort are identified below:



11.3.2. COMPANY Responsibility. Submission of a proposal under this RPP will constitute a grant of authority by the COMPANY to the Government to allow the use of Government support contractors to operate, use or access the data/Products solely on Government's behalf, and such use or access shall be subject to the terms of this Agreement. If the COMPANY determines the need to enter into a non-disclosure agreement directly with the Government support contractor, the COMPANY shall notify the Agreements Officer, DIU PM and AOR in writing.

11.4. Limited Warranty

Limited Warranty and Remedy for Software. COMPANY warrants that the Software, as delivered to Government, will substantially perform as stated. The Government will notify COMPANY of a claim under this warranty within 30 days of the date on which the condition giving rise to the claim first appeared. To the extent permitted by law, Government's sole and exclusive remedy and COMPANY's sole liability under or in connection with this warranty will be a replacement of the Distributed Code (as applicable), or if replacement is not commercially reasonable, a termination of the applicable Software and a refund of any pre-paid unused fees for the applicable Software.

ARTICLE 12: FOREIGN ACCESS TO TECHNOLOGY

This Article shall remain in effect during the term of the Agreement and for five (5) years thereafter.

12.1. General

The Parties agree that research findings and technology developments arising under this Agreement may constitute a significant enhancement to the national defense, and to the economic vitality of the United States. Accordingly, access to important technology developments under this Agreement by Foreign Firms or Institutions must be carefully controlled. The controls contemplated in this Article are in addition to, and are not intended to change or supersede, the provisions of the International Traffic in Arms Regulations (22

C.F.R. Part 120, et seq.), the National Industrial Security Program Operating Manual (NISPOM) (DoD 5220.22-M), and the Department of Commerce's Export Administration Regulations (15 C.F.R. Part 730, et seq.).

12.2. Restrictions on Sale or Transfer of Technology to Foreign Firms or Institutions

12.2.1. In order to promote the national security interests of the United States and to effectuate the policies that underlie the regulations cited above, the procedures stated in Article 12.2.2, 12.2.3, and 12.2.4 below shall apply to any transfer of Technology. For purposes of this paragraph, a transfer includes a sale of the company, or sales or licensing of Technology. Transfers include:

- a. Sales of products or components; or
- b. Licenses of the software or documentation related to sales of products or components; or
- c. Transfer to foreign subsidiaries of the COMPANY for purposes related to this Agreement; or
- d. Transfer which provides access to Technology to a Foreign Firm or Institution which is an approved source of supply or source for the conduct of research under this Agreement provided that such transfer shall be limited to that necessary to allow the firm or institution to perform its approved role under this Agreement.

12.2.2. The COMPANY shall provide timely notice to the Government of any proposed transfers from the COMPANY of Technology developed under this Agreement to Foreign Firms or Institutions. If the Government determines that the transfer may have adverse consequences to the national security interests of the United States, the COMPANY, its vendors, and the Government shall jointly endeavor to find alternatives to the proposed transfer which obviate or mitigate potential adverse consequences of the transfer but which provide substantially equivalent benefits to the COMPANY.

12.2.3. In any event, the COMPANY shall provide written notice to the Agreements Officer of any proposed transfer to a foreign firm or institution at least sixty (60) calendar days prior to the proposed date of transfer. Such notice shall cite this Article and shall state specifically what is to be transferred and the general terms of the transfer. Within thirty (30) calendar days of receipt of the COMPANY's written notification, the Agreements Officer shall advise the COMPANY whether it consents to the proposed transfer. In cases where the Government does not concur or sixty (60) calendar days after receipt and the Government provides no decision, the COMPANY may utilize the procedures under Article V, Disputes. No transfer shall take place until a decision is rendered.

12.2.4. In the event a transfer of Technology to Foreign firms or Institutions which is NOT approved by the Government takes place, the COMPANY shall (a) refund to the Government funds paid for the development of the Technology and (b) the Government shall have a non-exclusive, nontransferable, irrevocable, paid-up license to practice, or to have practiced on behalf of the United States the Technology throughout the world for Government and any and all other purposes, particularly to effectuate the intent of this Agreement. Upon request of the Government, the COMPANY shall provide written confirmation of such licenses.

12.3. Export Compliance

Each Party agrees to comply with U.S. Export regulations including, but not limited to, the requirements of the Arms Export Control Act, 22 U.S.C. § § 2751-2794, including the International Traffic in Arms Regulation (ITAR), 22 C.F.R. § 120 et seq.; and the Export Administration Act, 50 U.S.C. app. § 2401-2420. Each party is responsible for obtaining from the Government export licenses or other

authorizations/approvals, if required, for information or materials provided from one party to another under this Agreement. Accordingly, the COMPANY shall not export, directly, or indirectly, any products and/or technology, Confidential Information, Trade Secrets, or Classified and Unclassified Technical Data in violation of any U.S. Export laws or regulations.

12.4. Lower Tier Agreements

The COMPANY shall include this Article, suitably modified, to identify the Parties, in all subcontracts or lower tier agreements, regardless of tier, for experimental, developmental, or research work.

ARTICLE 13: OPERATIONAL SECURITY

Access and General Protection/Security Policy and Procedures. All COMPANY employees, including subcontractor employees, shall comply with all installation and facility access and local security policies and procedures (provided by Government representative), and security/emergency management exercises. The COMPANY shall also provide all information required for background checks to meet installation access requirements. The COMPANY workforce shall comply with all personal identity verification and accountability requirements as directed by DoD, the Government customer and/or local policy. Should the Force Protection Condition (FPCON) at any individual facility or installation change, the Government may require changes in COMPANY security matters or processes. During FPCONs Charlie and Delta, services/installation access may be discontinued/postponed due to higher threat. Services will resume when FPCON level and/or threat is reduced to an acceptable level as determined by the Installation Commander. The COMPANY shall be subject to and comply with vehicle searches, wearing of ID badges, etc. If access to classified information becomes required in the performance of this Agreement such access will be in accordance with the DoD 5220.22-M, National Industrial Security Program Operating Manual (NISPO), and all applicable DoD personnel security regulations.

ARTICLE 14: GOVERNING LAW AND JURISDICTION

This Agreement shall be construed and enforced in accordance with the laws of the United States in a Federal Court with competent jurisdiction. Any dispute arising under this Agreement shall first be handled in accordance with Article 5: Disputes of this Agreement.

ARTICLE 15: TITLE TO AND DISPOSITION OF PROPERTY

Company is required to obtain Agreement Officer written approval for any acquired property valued at \$5,000 or more under this Agreement. The Government will not take title to Company acquired or produced property, except property the agreement identifies as deliverable property, unless the parties agree otherwise. Title to all other property shall remain with the COMPANY. The COMPANY shall be responsible for the maintenance, repair, protection, and preservation of all such property at its own expense.

ARTICLE 16: GOVERNMENT FURNISHED PROPERTY

The Government will provide the COMPANY with the Government Furnished Property (GFP) listed in the Statement of Work (SOW) and/or referenced in a Government Furnished Property List that may be incorporated as an attachment to this Agreement to facilitate the performance of this OTA.

The COMPANY shall assume the risk of and be responsible for any loss or destruction of, or damage to, the GFP while it is in the COMPANY's possession or control, with the exception of reasonable wear and tear or reasonable and proper consumption. The GFP shall be returned at the end of the OTA Period of Performance in a condition that is as good as when it was received with the exception of said reasonable wear and tear, or in accordance with the provisions of the OTA regarding its use. The COMPANY shall obtain explicit written authorization for any transfer or disposition of the GFP.

ARTICLE 17: SAFEGUARDING COVERED DEFENSE INFORMATION AND CYBER INCIDENT REPORTING

17.1. Adequate Security. The COMPANY shall provide adequate security on all covered COMPANY information systems. To provide adequate security, the COMPANY shall implement, at a minimum, the following information security protections:

17.1.1. For covered COMPANY information systems that are part of an Information Technology (IT) service or system operated on behalf of the Government, the following security requirements apply:

a. Cloud computing services shall be subject to the security requirements specified:

(1) The COMPANY shall implement and maintain administrative, technical, and physical safeguards and controls with the security level and services required in accordance with the Cloud Computing Security Requirements Guide (SRG) found at http://iase.disa.mil/cloud_security/Pages/index.aspx, unless notified by the Agreements Officer Representative that this requirement has been waived by the DoD Chief Information Officer.

(2) The COMPANY shall maintain within the United States or outlying areas all Government data that is not physically located on Government premises, unless the COMPANY receives written notification from the Agreements Officer Representative to use another location.

b. Any other such IT service or system (i.e., other than cloud computing) shall be subject to the security requirements specified elsewhere in this contract.

17.1.2. For 'covered COMPANY information systems' that are not part of an IT service or system operated on behalf of the Government and therefore are not subject to the security requirement specified at Article 17.1.1., the following security requirements apply:

a. Except as provided in Article 17.1.1.b, the covered COMPANY information system shall be subject to the security requirements in National Institute of Standards and Technology (NIST) Special Publication (SP) 800-171, "Protecting Controlled Unclassified Information in Nonfederal Information Systems and Organizations" (available via the internet at <http://dx.doi.org/10.6028/NIST.SP.800-171>) in effect at the time the solicitation is issued or as authorized by the Contracting Officer.

b. The National Institute of Standards and Technology Considerations:

(1) The COMPANY shall implement NIST SP 800-171, as soon as practical.

(2) The COMPANY shall submit requests to vary from NIST SP 800-171 in writing to the Agreements Officer, for consideration by the DoD CIO. The COMPANY need not implement any security requirement adjudicated by an authorized representative of the DoD CIO to be non-applicable or to have an alternative, but equally effective, security measures that may be implemented in its place.

(3) If the DoD CIO has previously adjudicated the COMPANY's requests indicating that a requirement is not applicable or that an alternative security measure is equally effective, a copy of that approval shall be provided to the Agreements Officer or Agreements Officer Representative when requesting its recognition under this agreement.

(4) If the COMPANY intends to use an external cloud service provider to store, process, or transmit any covered defense information in performance of this contract, the COMPANY shall require and ensure that the cloud service provider meets security requirements equivalent to those established by the Government for the Federal Risk and Authorization Management Program (FedRAMP) Moderate baseline (<https://www.fedramp.gov/resources/documents/>) and that the cloud service provider complies with requirements in Article 17.2 to 17.6 for cyber incident reporting, malicious software, media preservation and protection, access to additional information and equipment necessary for forensic analysis, and cyber incident damage assessment.

17.1.3. Apply other information systems security measures when the COMPANY reasonably determines that information systems security measures, in addition to those identified in Article 17.1.2.b(1) and Article 17.1.2.b(2), may be required to provide adequate security in a dynamic environment or to accommodate special circumstances (e.g., medical devices) and any individual, isolated, or temporary deficiencies based on an assessed risk or vulnerability. These measures may be addressed in a system security plan.

17.2. Cyber Incident Reporting Requirement

17.2.1. When the COMPANY discovers a cyber incident that affects a covered COMPANY information system or the covered defense information residing therein, or that affects the COMPANY's ability to perform the requirements of the contract that are designated as operationally critical support and identified in the agreement, the COMPANY shall—

a. Conduct a review for evidence of compromise of covered defense information, including, but not limited to, identifying compromised computers, servers, specific data, and user accounts. This review shall also include analyzing covered COMPANY information system(s) that were part of the cyber incident, as well as other information systems on the COMPANY's network(s), that may have been accessed as a result of the incident in order to identify compromised covered defense information, or that affect the COMPANY's ability to provide operationally critical support; and

b. Rapidly report any cyber incident(s) within 72 hours of discovery to DoD at <http://dibnet.dod.mil>

17.2.2. Cyber incident report. The cyber incident report shall be treated as information created by or for DoD and shall include, at a minimum, the required elements at <http://dibnet.dod.mil>.

17.2.3. Medium assurance certificate requirement. In order to report cyber incidents in accordance with this clause, the COMPANY or subcontractor shall have or acquire a DoD-approved medium assurance certificate to report cyber incidents. For information on obtaining a DoD-approved medium assurance certificate, see <http://iase.disa.mil/pki/cca/Pages/index.aspx>.

17.3. Malicious software. When the COMPANY or subcontractors discover and isolate malicious software in connection with a reported cyber incident, submit the malicious software to DoD Cyber Crime Center (DC3) at this website: <https://www.dc3.mil/> or in accordance with additional instructions provided by DC3 or the Agreements Officer or the Agreements Officer Representative. Do not send the malicious software to the Agreements Officer or Agreements Officer Representative.

17.4. Media preservation and protection. When a COMPANY discovers a cyber incident has occurred, the COMPANY shall preserve and protect images of all known affected information systems identified in Article 17.2.1.a and all relevant monitoring/packet capture data for at least 90 days from the submission of the cyber incident report to allow DoD to request the media or decline interest.

17.5. Access to additional information or equipment necessary for forensic analysis. Upon request by DoD, the COMPANY shall provide DoD with access to additional information or equipment that is necessary to conduct a forensic analysis.

17.6. Cyber incident damage assessment activities. If DoD elects to conduct a damage assessment, the AO will request that the COMPANY provide all of the damage assessment information gathered in accordance with Article 17.4.

17.7. DoD safeguarding and use of COMPANY attributional/proprietary information. The Government shall protect against the unauthorized use or release of information obtained from the COMPANY (or derived from information obtained from the COMPANY) under this clause that includes COMPANY attributional/proprietary information, including such information submitted in accordance with Article 17.2. To the maximum extent practicable, the COMPANY shall identify and mark attributional/proprietary information. In making an authorized release of such information, the Government will implement appropriate procedures to minimize the COMPANY attributional/proprietary information that is included in such authorized release, seeking to include only that information that is necessary for the authorized purpose(s) for which the information is being released.

17.8. Use and release of COMPANY attributional/proprietary information not created by or for DoD

Information that is obtained from the COMPANY (or derived from information obtained from the COMPANY) under this clause that is not created by or for the Government is authorized to be released outside of Government-

1. To entities with missions that may be affected by such information;
2. To entities that may be called upon to assist in the diagnosis, detection, or mitigation of cyber incidents;
3. To Government entities that conduct counterintelligence or law enforcement investigations;
4. For national security purposes, including cyber situational awareness and defense purposes (including with Defense Industrial Base (DIB) participants in the program at 32 CFR part 236).

17.9. Use and release of COMPANY attributional/proprietary information created by or for DoD

Information that is obtained from the COMPANY (or derived from information obtained from the COMPANY) under this Article that is created by or for the Government (including the information submitted pursuant to Article 17.2) is authorized to be used and released outside of the Government for purposes and activities authorized by Article 17.8 , and for any other lawful Government purpose or

activity, subject to all applicable statutory, regulatory, and policy based restrictions on the Government's use and release of such information.

17.10. Other safeguarding or reporting requirements. The safeguarding and cyber incident reporting required by this clause in no way abrogates the COMPANY's responsibility for other safeguarding or cyber incident reporting pertaining to its unclassified information systems as required by other applicable clauses of this contract, or as a result of other applicable U.S. Government statutory or regulatory requirements.

17.11. Lower Tier Agreements. The COMPANY shall include this Article, suitably modified to identify the Parties, in all subcontracts or lower tier agreements entered into solely in connection with this Agreement.

ARTICLE 18: STATUTORY AUTHORITY

This Agreement is not a Federal procurement contract, grant or cooperative agreement. Nothing in this Agreement or its attachments will be construed as incorporating by reference or implication any provision of Federal acquisition law or regulation not specifically mentioned in this Agreement. This Agreement is subject to the compliance requirements of Title VI of the Civil Rights Act of 1964 as amended (42 U.S.C. § 2000d) relating to nondiscrimination in Federally assisted programs. The COMPANY has signed an Assurance of Compliance with the nondiscriminatory provisions of the Act. Additionally, this Agreement is subject to the Trafficking Victims Protection Act of 2000, as amended (22 U.S.C. chapter 78), Executive Order 13627, Strengthening Protections Against Trafficking in Persons in Federal Contracts, the international Traffic in Arms Regulations (22 C.F.R. Part 120, et seq.), the National Industrial Security Program Operating Manual (NISPOM) (DoD 5220.22-M), the Department of Commerce's Export Administration Regulations (15 C.F.R. Part 730, et seq.), and the Federal Property and Administrative Services Act (40 U.S.C. chapter 5), to the extent applicable to the activities to be conducted under this Agreement. In addition, the Procurement integrity Act (41 U.S.C. §2101-2107) shall apply to this Agreement.

ARTICLE 19: INDEMNITY

19.1. The COMPANY shall defend, indemnify and hold the Government harmless (including payment of all reasonable costs, attorneys' fees, settlements and damages) from any actions brought against Government to the extent that it is based on a claim that the Products or Documentation infringe any U.S. registered copyright of any third party, provided that: (i) the COMPANY is promptly notified in writing of the claim; (ii) the COMPANY has sole control of the investigation, preparation, defense, and/or settlement of such claim, and the Government does not settle such claim without the COMPANY's consent; and (iii) at the COMPANY's request and expense, Government provides reasonable assistance and information to the COMPANY. Nothing contained herein shall be deemed to contradict or contravene the authority of the Department of Justice as per 28 USC §516.

19.2. In the event of any such infringement claim, the COMPANY may at its sole option:

1. replace the infringing Products with functionally equivalent software;
2. modify such Products to render the same non- infringing, while retaining substantively equivalent functionality

3. procure for the Government a license to continue to use such Products under the terms of this Agreement; or

4. if the foregoing are not commercially reasonable, direct the Government to terminate use of such Products. If the COMPANY directs Government to terminate use of such Products (or a permanent injunction is issued against such use), the COMPANY shall refund any prepaid unearned fees as of the date of the termination.

19.3. Notwithstanding the foregoing, the COMPANY will have no liability with respect to any claim that arises from any such infringement claim to the extent that it results from: (i) use, operation, or combination of the Products or Documentation with programs, data, equipment, or materials not provided by the COMPANY if such infringement would have been avoided by the use of the Products or Documentation without such other programs, data, equipment, or materials; (ii) modifications to the Products made by a party other than COMPANY or its agents; (iii) data accessed or generated by the Products (including, without limitation Third Party Materials); (iv) the combination, operation or use of the Products with equipment, devices, data or software not provided or approved by COMPANY; (v) the Government's failure to use updated or modified versions of the Products provided by COMPANY to avoid a claim; (vi) COMPANY's compliance with any specifications or requirements provided by Government; or (vii) the Government's use of the Products other than in accordance with this Agreement.

19.4. This article specified the Government's sole and exclusive remedy and the COMPANY'S sole and exclusive obligation with respect to the infringement of intellectual property rights.

19.5. The Government shall not indemnify any entity. The Government agrees to pay for any loss, liability or expense, which arises out of or relates to the Government's acts or omissions with respect to its obligations hereunder, where a final determination of liability on the part of the Government is established by a court of law, or where settlement has been agreed to by the Government agency with, where appropriate, the coordination of the Department of Justice. This provision shall not be construed to limit the Government's rights, claims or defenses which arise as a matter of law or pursuant to any other provision of this Agreement

ARTICLE 20: ASSIGNMENT AND TRANSFER

Neither Party may assign, reassign, or transfer such Party's rights and obligations under this Agreement without the prior written consent of the other Party, provided that (1) the Government may delegate or transfer its administrative authority over this Agreement to a different Agreements Officer within the U.S. Department of Defense, and (2) nothing herein shall be construed to preclude Company from assigning proceeds under this Agreement in accordance with the Assignment of Claims Act. Any assignment, reassignment or transfer is subject to payment of then- current license and support fees, as applicable for the number of Applications required by such assignee or transferee

ARTICLE 21: FORCE MAJEURE

Neither Parties failure or omission in the performance of any obligation of this Agreement shall be deemed a breach of this Agreement or create any liability if the same shall arise from any cause or causes beyond the control of the Parties, including but not limited to, the following: acts of God; Acts or omissions of any Government; Any rules, regulations or orders issued by any Governmental authority or by any officer, department, and agency or instrumentality thereof; fire; storm; flood; earthquake; accident; war; rebellion;

insurrection; riot; and invasion and provided that such failure or omission resulting from one of the above causes is cured as soon as is practicable after the occurrence of one or more of the above mentioned cause.

ARTICLE 22: ORDER OF PRECEDENCE

In the event of any inconsistency between the terms and conditions of this Agreement and language set forth in the Attachments, the inconsistency shall be resolved by giving precedence in the following order: (1) The Agreement, and (2) all Attachments to the Agreement.

ARTICLE 23: MISCELLANEOUS

23.1. Entire Agreement. This Agreement constitutes the entire agreement of the Parties and supersedes all prior and contemporaneous agreements, understandings, negotiations, and discussions among the Parties, whether oral or written, with respect to the subject matter hereof.

23.2. Severability. To the extent permitted by applicable law, the parties hereby waive any provision of law that would render any clause of this Agreement invalid or otherwise unenforceable in any respect. If a provision of this Agreement is held to be invalid or otherwise unenforceable, such provision will be interpreted to fulfill its intended purpose to the maximum extent permitted by applicable law, and the remaining provisions of this Agreement will continue in full force and effect.

23.3. Headings. The headings appearing at the beginning of the sections contained in this Agreement have been inserted for identification and reference purposes only and shall not be used in the construction and interpretation of this Agreement.

23.4. Counterparts. This Agreement, or modifications thereto, may be executed in counterparts each of which shall be deemed as original, but all of which taken together shall constitute one and the same instrument.

ARTICLE 24: ENSURING ADEQUATE COVID-19 SAFETY PROTOCOLS FOR FEDERAL CONTRACTORS (DEVIATION 2021-O0009) (OCT 2021)

(a) *Definition.* As used in this clause –

United States or its outlying areas means—

- (1) The fifty States;
- (2) The District of Columbia;
- (3) The commonwealths of Puerto Rico and the Northern Mariana Islands;
- (4) The territories of American Samoa, Guam, and the United States Virgin Islands; and
- (5) The minor outlying islands of Baker Island, Howland Island, Jarvis Island, Johnston Atoll, Kingman Reef, Midway Islands, Navassa Island, Palmyra Atoll, and Wake Atoll.

(b) *Authority.* This clause implements Executive Order 14042, Ensuring Adequate COVID Safety Protocols for Federal Contractors, dated September 9, 2021 (published in the *Federal Register* on September 14, 2021, 86 FR 50985).

(c) *Compliance.* The Contractor shall comply with all guidance, including guidance conveyed through Frequently Asked Questions, as amended during the performance of this contract, for contractor or subcontractor workplace locations published by the Safer Federal Workforce Task Force (Task Force Guidance) at <https://www.saferfederalworkforce.gov/contractors/>.

(d) *Subcontracts.* The Contractor shall include the substance of this clause, including this paragraph (d), in subcontracts at any tier that exceed the simplified acquisition threshold, as defined in Federal Acquisition Regulation 2.101 on the date of subcontract award, and are for services, including construction, performed in whole or in part within the United States or its outlying areas.

**ATTACHMENT 1: STATEMENT OF WORK
STATEMENT OF WORK**

for

Autonomous EOD Maritime Response Vehicle

1.0 BACKGROUND:

██████████

Navy Explosive Ordnance Disposal (EOD) forces are manned, trained and equipped to neutralize or remove explosive hazards in the maritime and undersea environment to enable Naval and Joint force maneuver. The possible operational environments range from permissive to hostile. The physical environment also varies, including deep sea, littorals, very shallow water and surf zone, protected harbors and ports. Common to the disparate potential use cases is the requirement for highly mobile, rapidly deployable, highly reliable and sustainable solutions.

In contested operating environments, the presence of EOD operators in the operational area may present an unacceptable risk to force. In these circumstances the capability to conduct the full spectrum of EOD tasks using autonomous vehicles with a human-on-the-loop is desirable. To accomplish this, autonomous vehicles must be capable of detecting, localizing, navigating to, inspecting, identifying and – with human consent – neutralizing mine-like objects on the seafloor, in the water column, and at the water surface.

2.0 OBJECTIVE/SCOPE

The objective of this project is to develop a prototype autonomous EOD maritime response vehicle. To accomplish this, the Navy, in partnership with DIU, will retrofit the Navy's fielded Remotely Operated Vehicles (ROVs) with additional embedded hardware and software. Mature commercial technologies will be integrated onto the Navy's Mk 20 Mod 0, commercially marketed as the VideoRay Mission Specialist Series Defender.

The prototype will be evaluated on its ability to conduct the detect-to-engage spectrum of EOD tasks autonomously, the affordability of additional hardware components and software licenses, and interoperability with other Navy systems. The government will also consider the impact of data rights assertions.

Per this agreement, the program intends to procure prototype systems for government and fleet evaluation. The primary objective of this prototype phase is to integrate mature commercial off the shelf (COTS) technology onto fielded Navy ROVs to yield a new prototype system. To achieve this objective the program will evaluate the prototype system against the advertised government need, the manufacturer's advertised performance criteria, and the performance parameters outlined in section 4.0 of this agreement. The prototype system will be evaluated through a series of operationally relevant characterization and demonstration events to ensure effectiveness and suitability. These evaluations will be completed with various stakeholder Subject Matter Expert (SME) input, including fleet end-users.

3.0 APPLICABLE DOCUMENTS

- MIL-STD 810
- MIL-STD 461
- MIL-STD 129R
- Common Operator Interface Navy (COIN) Software Development Kit (SDK)
- Neptune/SOLAR SDK
- Mine Countermeasures Sensor Hierarchical Data Format (HDF) Specification
- VideoRay MSS Defender ICD

4.0 TECHNICAL REQUIREMENTS:

4.1 Task 1: Conduct Contract Kick-Off Meeting

4.1.1 The government shall host a virtual contract kick-off meeting with the contractor within 5 business days of contract award. The government shall provide a high-level overview of the *Task 4: Mine-Like Object Perception Demonstration* at the kickoff meeting.

4.1.2 The contractor shall provide a time-phased integrated master schedule (IMS) in an excel

spreadsheet at the kick-off meeting. The contractor shall assume that all subsequent priced optional milestones described below will be exercised within 14 days of completion of *Task 4: Mine-Like Object Perception Demonstration* event. In addition to the IMS, the contractor shall provide any subcontractor dependencies, "must-have" requirements, long lead time items and risk matrices.

4.1.3 The contractor shall ensure that subcontractors are represented at the kickoff meeting.

4.1.4 The contractor shall provide a list of personnel that will require access to the Government-owned Secure Unclassified Network (SUNet) environment no later than the Kick-Off Meeting. Every individual that requires access to SUNet will meet the following requirements: have completed the DoD Annual [Cyber Awareness Challenge](#) within the 6 months prior to contract award, sign the [SUNet User Agreement](#), submit required personal information (country of citizenship, contact information etc) to the government point of contact.

4.1.5 The government shall furnish SUNet login credentials to all contractor personnel who correctly complete access requirements within 21 days of receipt.

4.1.6 This task will exit successfully upon end of the Kickoff meeting and delivery of the specified materials.

4.2 Task 2: Data Collection Event 1

4.2.1 The government shall furnish a Computer-Assisted Design (CAD) digital file of a mine-like object within 14 days of contract award which will be transmitted through SUNet.

4.2.2 The government shall host a 1 to 2 day data collection event for the contractor at the Naval Information Warfare Center - Pacific (NIWC-PAC) within 30 days of contract award.

4.2.3 The contractor shall participate in Data Collection Event 1 at NIWC-PAC. The contractor shall collect data at this event utilizing the combination of sensors (sonar and electro-optical [E-O]) that will be subsequently used to develop and train the object detection & tracking algorithm for *Task 4: Mine-Like Object Perception Demonstration*.

4.2.4 The contractor shall, at Data Collection Event 1, facilitate the collection of data for the government to use as a validation set in later testing. The contractor shall assist the government in gathering data using the contractor's sensors, and saving the collected data to a separate government furnished data storage device. This data shall not be retained by the contractor, or used - in whole or in part - in the training of the contractors object detection & tracking algorithm prior to *Task 4: Mine-Like Object Perception Demonstration*.

4.2.5 This task will exit successfully upon collection of data for contractor use and delivery of validation data to the Government.

4.3 Task 3: Data Collection Event 2

4.3.1 The government shall host a 1 to 2 day data collection event for the contractor at the NIWC-PAC no later than 30 days prior to the start of *Task 4: Mine-Like Object Perception Demonstration*.

4.3.2 The contractor shall participate in Data Collection Event 2 at NIWC-PAC. The contractor shall collect data at this event utilizing the combination of sensors (sonar and E-O) that will be subsequently used to develop and train the object detection & tracking algorithm for *Task 4: Mine-Like Object Perception Demonstration*.

4.3.3 The contractor shall, at Data Collection Event 2, facilitate the collection of data for the government to use as a validation set in later testing. The contractor shall assist the government in gathering data using the contractors sensors, and saving the collected data to a separate government furnished storage device. This data shall not be retained by the contractor, or used - in whole or in part - in the training of the contractors object detection & tracking algorithm prior to *Task 4: Mine-Like Object Perception Demonstration*.

4.3.4 This task will exit successfully upon collection of data for contractor use and delivery of validation data to the Government.

4.4 Task 4: Mine-Like Object Perception Demonstration

4.4.1 The contractor shall participate in an object perception demonstration at NIWC-PAC within 4 months of contract award. The object perception demonstration may include an in-simulation evaluation of object recognition algorithm performance and a live in-water demonstration of the perception subsystem. The perception system sensors are not required to be integrated onto a vehicle for the purposes of this demonstration, and may be manually controlled by an operator. Additionally, the object recognition algorithms are not required to run on embedded hardware for the purposes of this demonstration. The demonstration will evaluate the object detection & tracking algorithm based on the following criteria:

- **Distance from object at initial detection**



In addition the government shall assess the perception system qualitatively based on characteristics such as accuracy and precision of distance to object estimates, form factor compatibility, size, weight and power usage (SWAP).

4.4.2 The contractor shall deliver a copy of the object detection & tracking algorithm not later than 5 days prior to the object detection demonstration. The object detection & tracking algorithm shall be delivered to the government in the Secure Unclassified Network (SUNet).

4.4.3 The contractor shall deliver a copy of the labeled training dataset (real and synthetic) used to train the object detection & tracking algorithm delivered under section 4.4.2. The dataset shall be delivered to the government in the Secure Unclassified Network (SUNet).

4.4.4 [Removed as of Modification 2]

4.4.5 This task will exit successfully upon completion of the demonstration event and delivery of the specified materials.

4.5 Task 5: Monthly Report

4.5.1 The contractor shall prepare monthly reports covering project tasks including build, delivery, testing, training, development, feedback, and recommendations. Reports will be submitted through the project folder on the Defense Intelligence Information Enterprise (<https://www.di2e.net/>). Report contents will be further refined between the government and the contractor over the period of performance.

4.5.2 The contractor shall provide a list of personnel that will require access to the project DI2E project folder no later than the Kick-Off Meeting

4.5.3 This task will exit successfully upon completion of the Task 4 demonstration event and delivery of the specified materials.

4.6 Task 6: Bi-Weekly Meeting

4.6.1 The contractor will host virtual bi-weekly update meetings with the government team. Topics will include status updates on build, delivery, testing, training, development, feedback, and recommendations. In addition any schedule deviations, changes to the status of long lead time items, significant changes to risk matrices, and other items with the potential to impact project success at the contractors discretion. Bi-weekly meeting agenda will be further refined between the government and the contractor over the period of performance.

4.6.2 This task will exit successfully upon completion of the Task 4 demonstration event and delivery of the specified materials.

4.7 Task 7: Preliminary Design Review (PDR)

4.7.1 The contractor shall host a PDR meeting within 30 days After Option Exercise (AOE) and submit supporting documentation no later than 48 hours prior to the PDR meeting.

4.7.2 The contractor shall include the following items in the PDR documentation: overall preliminary system description, overall block diagram and component specifications, preliminary CAD models for prototype vehicle, to include any planned new sensor integrations, preliminary SWaP estimates/budgets, preliminary interface control documentation (ICDs), preliminary software architecture and a list of long lead items with cost and dates required for procurement to support on-schedule delivery, risk matrices, dependencies and impacts.

4.7.3 The government shall review the PDR within 7 days and notify the contractor of approval or any deficiencies.

4.7.4 The contractor shall not proceed to later milestones without the express written direction of the Agreements Officer.

4.7.5 This task will exit successfully upon completion of the PDR meeting, delivery of specified materials, and delivered response government notice of approval or deficiencies.

4.7.6 The contractor shall deliver a report to the government no later than 5 days prior to the object detection demonstration. The report shall include:

- An analysis of the feasibility of deploying the demonstrated object recognition algorithm to embedded hardware aboard the Mk 20, Mod 0 (VideoRay MSS Defender ROV).
- The report should also detail any required hardware updates to the Mk 20, Mod 0 that the contractor views as necessary.
- An analysis of how the contractor would approach generating excerpts from the post-ATR processed sensor data that is optimized for transmission over bandwidth constrained communications links - specifically acoustic communications links.

4.8 Task 8: Critical Design Review (CDR)

4.8.1 The contractor shall host a CDR meeting within 90 days AOE and submit supporting documentation no later than 48 hours prior to the CDR meeting.

4.8.2 The contractor shall include the following items in the CDR documentation: overall final system description, overall block diagram and component specifications, final CAD models for prototype vehicle, to include any planned new sensor integrations, final SWaP estimates/budgets, interface control documentation (ICDs), software architecture and a status update on long lead items with cost and dates required for procurement to support on-schedule delivery, risk matrices, dependencies and impacts.

4.8.3 The government shall review the PDR within 7 days and notify the contractor of approval or any deficiencies.

4.8.4 The contractor shall not proceed to later milestones without the express written direction of the Agreements Officer.

4.8.5 This task will exit successfully upon completion of the PDR meeting, delivery of specified materials, and delivered response government notice of approval or deficiencies.

4.9 Task 9: Hardware-in-the-Loop Demonstration:

4.9.1 The contractor shall host a hardware-in-the-loop demonstration either virtually or at the contractor's location within 5 months AOE.

4.9.2 The contractor shall demonstrate the integration of the perception subsystem onto the vehicle, and demonstrate the ability of those algorithms to provide useful data to the autonomy subsystem. The object recognition algorithms are required to run on embedded hardware for the purposes of this demonstration.

4.9.3 The contractor may use their own proprietary simulation environments or an open-source simulation environment - such as Gazebo.

4.9.4 This task will exit successfully upon end of the demonstration event.

4.10 Task 10: 50% Prototype Build & Tethered Autonomy Demonstration

4.10.1 The contractor shall notify the government when the prototype vehicle reaches 50% completion, no later than 8 months AOE.

4.10.2 The contractor shall participate in a tethered autonomy demonstration at NIWC-PAC within 8 months AOE. The tethered autonomy demonstration will demonstrate the prototype's ability to navigate to a point, given coordinates, reacquire a known object type, based on autonomous perception systems, conduct an inspection of the object, identify the object and notify the operator of the result. The demonstration may include live in-water demonstration in both controlled clear and turbid water environments.

4.10.3 The contractor shall demonstrate the ability to maneuver and navigate autonomously, and safely relative to the object in controlled clear or turbid water environments. The autonomy and navigation subsystems are required to operate on embedded hardware. The operator may pass commands to the vehicle over a tethered connection for the purposes of this demonstration, but surface computing resources shall not be used by the vehicle.

4.10.4 The contractor shall demonstrate the integration of the perception subsystem onto the vehicle, and demonstrate the ability of the object detection & tracking algorithm to provide data to the autonomy subsystem. The object recognition algorithms are required to run on embedded hardware for the purposes of this demonstration.

4.10.5 This task will exit successfully upon end of the demonstration event.

4.11 Task 11: Prototype Completion & Untethered Autonomy Demonstration I

4.11.1 The contractor shall deliver a complete prototype within 12 months AOE. The contractor shall demonstrate the integration of all subsystems onto the vehicle.

4.11.2 The contractor shall participate in an untethered autonomy demonstration at NIWC-PAC in controlled clear or turbid environments within 12 months AOE. The untethered autonomy demonstration will demonstrate the prototype's ability to navigate to a point, given coordinates, reacquire a known object type based on autonomous perception systems, and conduct an inspection of the object, identify the object and notify the operator of the result.

4.11.3 The government and contractor shall refine the parameters of this demonstration prior to award.

4.11.4 This task will exit successfully upon end of the demonstration event.

4.12 Task 12: Interface Control Documentation Delivery

4.12.1 The contractor shall deliver a comprehensive ICD for the prototype and its subsystems within 15 months AOE.

4.12.2 The contractor shall include as part of the ICD deliverable,

- Hardware:
 - Power required: Voltage level, amps, peak amps, nominal amps
 - Mounting: mounting hole patten and thread size
 - Weight in air
 - Weight in water
 - Depth rating
 - Connector types and connector pin outs
- Software:
 - CPU requirement, (MFLOPs)
 - Memory space for code execution
 - Hard disk space for binary
 - IP address
 - Data protocols
 - Data input requirement to include data format, and expected frequency
 - Data output to include data format, and output frequency
 - Hard disk space for output data
 - File format for output data

4.12.3 This task will exit successfully upon delivery of the ICD.

4.13 Task 13: Environmental Testing Support

4.13.1 The contractor shall provide environmental testing support to the government of up to 100 hours in order to support the hardening and ability of the prototype to work in various environments (warm/cold water, vibrations, etc). The contractor shall support the government by providing technical expertise in system operation, training, troubleshooting, debugging, and updating firmware to address critical issues that occur during testing.

4.13.2 This task will exit successfully upon complete utilization of the allocated hours, or completion of the test events whichever occurs first.

4.14 Task 14: Open Architecture Compliance Report Delivery

4.14.1 The contractor shall have a physical and operating architecture capable of hosting compatibility-designed third party software and or hardware payloads that can be reconfigured in the field.

4.14.2 The contractor shall provide a report within 15 months AOE, documenting compliance with the Navy's Unmanned Maritime Autonomy Architecture (UMAA). The report shall document any instances where existing UMAA interface control documentation does not exist or is insufficient, and the contractor's recommendation to remedy the deficiency.

4.14.3 This task will exit successfully upon delivery of the compliance report.

4.15 Task 15: Automated Target Recognition Library Expansion 1

4.15.1 The government will provide up to 4x physical mine-surrogates, mine-simulators, or mine-like object shapes, or digital representations thereof.

4.15.2 The contractor will collect, label and deliver labeled training datasets of the GFE-objects into SUNet, no later than 3 months AOE.

4.15.3 The contractor will upgrade the prototype's perception system to detect, classify and identify the mine-surrogates, mine-simulators, and or mine-like object shapes, in diverse environmental conditions, and diverse physical conditions.

4.15.4 This task exits upon delivery of both the training datasets and delivery of the updated perception subsystem software.

4.16 Task 16: Automated Target Recognition Library Expansion 2

4.16.1 The government will provide up to 4x physical mine-surrogates, mine-simulators, or mine-like object shapes, or digital representations thereof.

4.16.2 The contractor will collect, label and deliver labeled training datasets of the GFE-objects into SUNet, no later than 3 months AOE.

4.16.3 The contractor will upgrade the prototype's perception system to detect, classify and identify the mine-surrogates, mine-simulators, and or mine-like object shapes, in diverse environmental conditions, and diverse physical conditions.

4.16.4 This task exits upon delivery of both the training datasets and delivery of the updated perception subsystem software.

4.17 Task 17: Automated Target Recognition Library Expansion 3

4.17.1 The government will provide up to 4x physical mine-surrogates, mine-simulators, or mine-like object shapes, or digital representations thereof.

4.17.2 The contractor will collect, label and deliver labeled training datasets of the GFE-objects into SUNet, no later than 3 months AOE.

4.17.3 The contractor will upgrade the prototype's perception system to detect, classify and identify the mine-surrogates, mine-simulators, and or mine-like object shapes, in diverse environmental conditions, and diverse physical conditions.

██████████ This task exits upon delivery of both the training datasets and delivery of the updated perception subsystem software.

4.18 Task 18: Payload Delivery Behavior Integration & Untethered Autonomy Demonstration 2

4.18.1 The contractor shall deliver an incremental software and hardware upgrade to the vehicle which enables autonomous delivery of government-furnished render safe/neutralization payload. The prototype is not required to affix the payload directly to the target.

4.18.2 The contractor shall demonstrate the ability to deliver the payload within specified standoff of the target. The prototype is not required to affix the payload directly to the target.

4.18.3 The government and contractor shall refine the parameters of this demonstration, including the timeline for execution, and negotiate cost prior to award.

4.18.4 This task will exit successfully upon end of the demonstration event.

4.19 Task 19: Integrate Alternate Sensor Payload 1

4.19.1 The government shall provide as GFE, or contractor may provide, an alternate Electro-Optical (E-O) sensor, or combination E-O & acoustic sensor payload for the prototype.

4.19.2 The contractor shall fully integrate the E-O sensor, or combination E-O/acoustic sensor, into the prototype to demonstrate the modularity of the system architecture.

4.19.3 The contractor and government shall negotiate the schedule and cost of additional sensor payload integration prior to award of this option.

4.19.4 The exit criteria for this task will be negotiated prior to award of this option.

4.20 Task 20: Integrate Alternate Sensor Payload 2

4.20.1 The government shall provide as GFE, or contractor may provide, an alternate Electro-Optical (E-O) sensor, or combination E-O & acoustic sensor payload for the prototype.

4.20.2 The contractor shall fully integrate the E-O sensor, or combination E-O/acoustic sensor, into the prototype to demonstrate the modularity of the system architecture.

4.20.3 The contractor and government shall negotiate the schedule and cost of additional sensor payload integration prior to award of this option.

4.20.4 The exit criteria for this task will be negotiated prior to award of this option.

4.21 Task 21: Integrate Alternate Sensor Payload 3

4.21.1 The government shall provide as GFE, or contractor may provide, an alternate Electro-Optical (E-O) sensor, or combination E-O & acoustic sensor payload for the prototype.

4.21.2 The contractor shall fully integrate the E-O sensor, or combination E-O/acoustic sensor, into the prototype to demonstrate the modularity of the system architecture.

4.21.3 The contractor and government shall negotiate the schedule and cost of additional sensor payload integration prior to award of this option.

4.21.4 The exit criteria for this task will be negotiated prior to award of this option.

4.22 Task 22: Integrate Alternate Communications Payload

4.22.1 The government shall provide as GFE, or contractor may provide, an alternate communications payload for the prototype.

4.22.2 The contractor shall fully integrate the communications payload into the prototype to demonstrate the modularity of the system architecture.

4.22.3 The contractor and government shall negotiate the schedule and cost of additional communications payload integration prior to award of this option.

4.22.4 The exit criteria for this task will be negotiated prior to award of this option.

4.23 Task 23: Engineering Services 1

4.23.1 The contractor shall provide engineering service support to the government of up to 100 hours in order to support and participate in cyber testing, supply chain analysis, operational testing and failure analysis/correction, if required by the government. The contractor shall support the government by providing technical expertise in system operation, training, troubleshooting, debugging, and updating firmware to address critical issues that occur during testing.

4.23.2 The contractor shall prepare and submit a report summarizing test results, root cause analysis of any system failures during testing, and recommendations for future system improvements.

4.23.3 The contractor and government shall negotiate the cost of engineering services support prior to award of this option.

4.23.4 This task will exit successfully upon complete utilization of the allocated hours.

4.24 Task 24: Engineering Services 2

4.24.1 The contractor shall provide engineering service support to the government of up to 100 hours in order to support and participate in cyber testing, supply chain analysis, operational testing and failure analysis/correction if required by the government. The contractor shall support the government by providing technical expertise in system operation, training, troubleshooting, debugging, and updating firmware to address critical issues that occur during testing.

4.24.2 The contractor shall prepare and submit a report summarizing test results, root cause analysis of any system failures during testing, and recommendations for future system improvements.

4.24.3 The contractor and government shall negotiate the cost of engineering services support prior to award of this option.

4.24.4 This task will exit successfully upon complete utilization of the allocated hours.

4.25 Task 25: Engineering Services 3

4.25.1 The contractor shall provide engineering service support to the government of up to 100 hours in order to support and participate in cyber testing, supply chain analysis, operational testing and failure analysis/correction if required by the government. The contractor shall support the

government by providing technical expertise in system operation, training, troubleshooting, debugging, and updating firmware to address critical issues that occur during testing.

4.25.2 The contractor shall prepare and submit a report summarizing test results, root cause analysis of any system failures during testing, and recommendations for future system improvements.

4.25.3 The contractor and government shall negotiate the cost of engineering services support prior to award of this option.

4.25.4 This task will exit successfully upon complete utilization of the allocated hours.

4.26 Task 26: Delivery of two (2) Prototypes

4.26.1 The contractor shall order long lead items and third party products within ten (10) days of initial receipt of funds.

4.26.2 The contractor shall notify the government when the order is placed.

4.26.3 The contractor shall notify the government when vehicle construction/assembly commences, is 50% complete, and when fully assembled and ready for contractor quality assurance testing.

4.26.4 The contractor shall perform a pressure chamber depth rating test of fully assembled contractor prototype and provide the government with written documentation of the test.

4.26.5 The contractor shall deliver to the government the two (2) prototypes which shall include all completed improvements/upgrades (if funded, and as described in Section 4 of this document) if completed before the initial receipt of funds, and all ancillary support equipment.

4.26.6 The contractor and government shall negotiate the schedule and cost for prototype delivery prior to award of this option.

4.26.7 This task will exit successfully upon government acceptance of the two prototypes.

4.27 Task 27: Conduct Government Operator Training

4.27.1 The contractor shall provide a 2-day operator training course followed by a 1-day maintainer course to designated government employees, at a location of the government's choosing. Course size not to exceed six (6) students.

4.27.2 The government shall provide feedback on the training following delivery of the course.

4.27.3 The contractor and government shall negotiate the schedule and cost for Operator Training prior to award of this option.

4.27.4 This task will exit successfully upon the end of the 2 day operator training course and the 1 day maintainer course.

5.0 TECHNICAL APPROACH

5.1 Background

The desire to remove human capital from harm's way in complex and dangerous maritime mine countermeasure missions (MCMs) has been a goal of the US Navy for years, and robotic assets are playing a central role in achieving this goal. However, current subsea robotics technology limits the extent and

degree in which these assets can be effectively utilized. The state-of-the-art software and hardware in small unmanned systems has created fault intolerant control systems and platforms which rely on significant operator input for any 'autonomous' actions in unstructured environments. Manipulation of objects subsea is inherently difficult using the current 'state-of-the-art' technology because the relative interaction dynamics between the vehicle and the desired object are not appropriately compensated for in the software and hardware stack. Due to this, current implementations of MCM location and neutralization technology on small unmanned systems still rely heavily on high bandwidth data links between vehicles and topside vessels in proximity, unnecessarily exposing the warfighter to danger.

As operators are required in the current technological paradigm, so are vessels. Vessels currently remain essential because of their utility in the long-range transport, deployment, and retrieval of the subsea robotic assets at the target site and more importantly, supporting the tether that enables high-bandwidth communications and power to the vehicle. Presently, no technological solutions exist within the Navy that enables the performance of complex subsea robotic manipulation and intervention tasks without the necessity of a topside vessel nearby. This technological gap will continue to unnecessarily subject warfighters to dangerous conditions while operating subsea assets due to the constraints of the robot and associated umbilical. This proposal provides a novel, but COTS, implementation of Houston Mechatronics' (HMI) core software stack, Nautilus, and pairs the software and autonomous architecture with the present Navy's Mk 20 Mod 0 Remotely Operated Vehicle (ROV) platform. This pairing enables complex runtime autonomous behaviors and the inclusion of perception hardware on a small platform. When implemented fully, we believe that the MK20 Mod 0 will have the capability to detect and classify targets of interest, navigate to them and around them, and place an object on them – all autonomously – and without a tether.

5.1.1 Prior work

HMI has developed the Nautilus software platform over the past 5 years. In that time Nautilus has grown from a mission management and control architecture to a comprehensive software package for mission simulation, mission management, communication management, perception processing and enablement, reporting, and vehicle actuation. Nautilus enables subsea vehicles to perform inspection and intervention tasks within a sliding scale of autonomy. Comprised of the following components listed in Figure 1. The Nautilus stack permits tether-less operational paradigms, effectively removing the need for an immediate surface expression over or near the area of operations. With Nautilus, Operators can deploy the vehicle at an initial safe standoff distance (ISSD) and transit to the minimum safe standoff distance (MSSD) to execute identification and neutralization missions. The vehicle carries out mission directives through user defined behaviors and has the capacity to react to dynamic and unstructured environmental conditions. Each component of Nautilus communicates through UMAA compliant message descriptions, enabling integration onto existing platforms and interaction with other existing tools that adhere to the standard. Commander is the primary user interface of Nautilus. Operators interact with Commander in order to view data from a platform, approve or disapprove of semi-autonomous actions, and take direct control of a platform. Commander may be used on platforms that do, and do not, have the ability to manipulate the environment. As shown in Figure 2, Commander's interface provides both mission planning, feedback, and management capability to operators. Commander loads synthetic objects in a 'digital twin' style as well as mission data in world coordinates.

Helmsman is the on-vehicle deployment of the Nautilus package which handles platform actuation, safety management, and platform control. Helmsman takes input from other components of Nautilus and determines how to translate that into safe actions for the platform. For example, if a user commands a vehicle to move 5 m to the east, Commander will send this command to a vehicle. Helmsman, running on the vehicle, will then translate and coordinate all actuation required to achieve the goal sent from Commander.

Wayfinder is the perception-oriented component of Nautilus. Wayfinder takes in sensor data and generates world modeling from the sensor data. Wayfinder supports 2-D and 3-D sensors like stereo optics and sonars. In order to support new sensors, the HMI team writes drivers for those sensors.

Wavelink is the communications component of Nautilus. HMI does not believe that subsea communications should be tied to a master/slave pair as they have for over three decades. Wavelink allows meshed Delay Tolerant Networking between a vehicle and an operator. Wavelink allows vehicles to seamlessly communicate with any topside infrastructure which is also powered by WaveLink communications.

Loggerhead is the low-level logging, payload data collection, processing, and report generation component of the Nautilus software architecture. Loggerhead was originally a critical tool used by HMI roboticists for actuator development as it allowed playback of any timeseries data collected by a robotic system. Now, as part of Nautilus, this low-level functionality has been paired with higher level data collection and processing capabilities to bridge the gap between raw and processed data. Autonomous mission planning, execution, and management in Nautilus utilizes behavior trees for complex fault tolerance. Originally found in game theory, behavior trees enable a fallback-style mission planning and execution. As shown in Figure 3, a behavior tree is a modular architecture for task execution. Complex subtasks can be represented as their own nested behavior tree. In this architecture, a tick source is set up and analyzes the state of all actions in the tree. If an action produces 'Success' the tree will progress to the next node. If an action produces a 'Fail', then the tree reverts to the previous node.

Behavior trees are runtime compiled and are as fault tolerant as users may make them. Therefore, this style of mission planning and execution is significantly more flexible than commonly deployed subsea software architectures.

An example which illustrates this is presented below. In our previous work Nautilus was deployed to execute a supervised autonomous task that localized and interacted with moored mines. The Nautilus component WayFinder was trained to detect hertz cone moored mines and generate pose estimates in the world frame in which Aquanaut, HMI's autonomous subsea robotic platform, could manipulate a tool to neutralize the threat. If Aquanaut failed an action the robot autonomously attempted the action again until an operator intervened.

In Figure 4 and 5, a simulated, inert moored mine was placed in the test area to act as the target of interaction. At a data rate of less than 3kbit/s, an operator commanded the vehicle to approach the mine and maintain position in order to attach a simulated disruptor charge placed on the mine in a user specified location. The experiment was executed 25 times to demonstrate the ability to dynamically replan to the same desired location even when the environment changed between each attempt.

In other work, HMI has also demonstrated completely autonomous and far more advanced subsea manipulation activities. In phase 1 of DARPA's Angler program, custom behaviors were executed within Nautilus component Commander to enable Aquanaut to detect and classify an object within a designated circular error probable (CEP) distance, retrieve an electrical cable and connector typically found in subsea oilfield fields, transited to a separate location where it identified the receptacle, and ultimately inserted the lead into its designated location.

Prior to the generation of this proposal HMI inserted the MK20 Mod 0 vehicle into our simulation environment. We modeled collection and processing of data via the optical sensor proposed for this project as well as autonomous control of the platform (Figure 6)

During this simulation, the Nautilus software was able to register the mine based on simulated point cloud data, direct the vehicle to the mine, and direct the vehicle to orbit the mine.

Figure 6. A MK20 Mod 0 platform shown in commander. Behaviors are located on the right for '1-button' click, and scene controls are on the left.

5.2 Objectives

The successful completion of this program will result in sensor package and software capabilities implemented on the MK20 Mod 0 that enable the vehicle to autonomously detect, navigate to, communicate with an operator, and neutralize the threat using various tools provided to the vehicle.

To satisfy DIU requirements in the base scope of work, HMI will first implement a robust sensing and detection capability through Wayfinder. Helmsman will be installed on a VideoRay Defender and will serve as the vehicle controller. Commander will be utilized as a User Interface and as a platform which deploys autonomous behaviors to the vehicle. HMI's proprietary machine learning pipeline, Hypnos, will be used to do data capture, annotate, generate models, and version control over deployed models.

In Option 1 of this scope of work HMI will deploy additional components of Nautilus to achieve greater vehicle autonomy. Specifically, Wavelink will be deployed with Subnero hardware to enable acoustic communication.

In Option 2 of this scope of work HMI will extend the platform to capture different payloads and models.

5.2.1 Base Scope of Work [SOW 4.1 - 4.4]

Before navigating to and neutralizing a mine, the vehicle must first classify the mine and localize it in relation to its current position. To date, this has typically been accomplished by torpedo shaped AUVs, incapable of station keeping and interacting with the environment. This has led to a collaborative approach between AUVs and human-operated, tethered ROVs. By enabling platforms like the MK20 Mod 0 with the appropriate sensing, autonomy, communications, and energy storage to accomplish autonomous work, human operators will be afforded a larger operational standoff distance. The vehicles currently fielded within the MESR program do not contain the compute platforms, nor the energy systems, necessary for untethered operation capabilities. In order to accomplish the base scope of work goals, HMI intends to integrate a perception package that will be capable of locating Targets-of-Interest (TOI) at various distances and turbidity conditions and generate models of specified customer objects to be executed in WayFinder. Existing offboard computer and power systems will be utilized as requested and specified in the SOW. Specifically, WayFinder will be deployed to detect and classify mine-like objects of known characteristics and determine both the distance and direction of those objects relative to the vehicle.

The ultimate objective of Phase I is to deploy a sensing solution capable of detecting mine-like objects utilizing the data collection events (SOW 4.2, 4.3), HMI will capture data in various positions and orientations in relation to the mine-like object to best inform the sensor kinematics to best perceive the environment and generate meaningful data for analysis. Additionally, the selected optical and sonar sensors will be characterized regarding distance capabilities, acoustic signature, lighting requirements, and abilities to operate in varying turbidity. The data sets generated during the initial collection events will serve as the starting point for model creation to be used by WayFinder. Follow on collection events will be used to further advance the models that are classifying the objects. This will be done by evaluating the models and identifying features that were not detected and added to the training pipeline.

Following successful completion of the data collection events and model creation, HMI will execute a demonstration using the perception system, running WayFinder on a topside compute solution. The ability to track the TOIs will be assessed quantitatively using provided metrics (SOW 4.4), and the perception system will be assessed using qualitative metrics of accuracy and precision to target, form factor, and SWaP.

5.2.2 Option 1 – Untethered Autonomy Objectives [SOW 4.7-4.17]

Once a robust perception system and detection framework have been established, the data will be used to facilitate the autonomous transit of the vehicle to complete further inspection of the object in this option period. In order to achieve semi-autonomous capabilities on the MK20 Mod 0, the full Nautilus software platform will be configured for deployment on the vehicle. Initial efforts will begin with configuring Helmsman to control the vehicle and expose the underlying access to the vehicle through a Hardware Abstraction Layer (HAL). Once exposed, existing control inputs through the operator console will be available; however, a feature rich control interface will be exposed for interaction with Commander. In parallel to the controller implementation, behaviors will be created for execution on the vehicle to replicate standard tactics, techniques, and procedures (TTPs) employed by operators. These behaviors are both event-driven and reactive to ensure a robust response to disturbances and unknowns in the environment.

To achieve true tether-less operation, an incremental approach to autonomy is undertaken. The current MK20 Mod 0 system does not contain compute or energy storage on board. As to not hinder progress towards the autonomy solution, a tethered demonstration will allow for validation of software capabilities without hardware restricting progress. Parallel to the software effort, a hardware effort to implement sufficient compute and energy will be realized on the vehicle.

Once the functionality of the autonomy framework has been validated and the vehicle upgrades are realized, fully autonomous tether-less operation can be accomplished. The objective of this demonstration will showcase the ability to fulfill the requirements provided [SOW 4.11.2]. HMI will deliver one (1) complete prototype vehicle to the Government at the conclusion of the demonstration.

5.2.3 Option 2 – Payload Delivery Objectives [SOW 4.18 - 4.27]

Neutralization and sensing payloads can vary greatly just as the threats the vehicle might encounter may vary. For this reason, it is imperative that the vehicle and supporting software can be easily adaptable to exchange payloads given the requirements of the operators. This option period will focus on the electromechanical interfaces of the vehicle, and the autonomy software that knows how to deploy the payload through actuation or making use of the sensed data.

Neutralization of a mine-like object requires the vehicle to reason what has been found, and more importantly, the appropriate steps for that specific item. Utilizing the identification libraries established through the program, behaviors will be created to utilize the provided neutralization device. This will include approach strategies, minimum stand-off distances, placement requirements, and actuations once commanded.

The vehicle can only neutralize what it can perceive in the environment. In order to expand the ability of the vehicle to detect and classify TOIs, provided sensors will be integrated onto the vehicle. This will consist of ensuring compatible electromechanical interfaces and drivers for sensors that expose data into WayFinder.

Upon successful demonstration of payload deployment and additional sensor integration, HMI will deliver 2 fully operational prototypes. These prototypes will have been upgraded with VideoRay's advancements in thruster performance, communications backbone throughput, energy storage solution and on-board compute. HMI will install the additional WaveLink communications capabilities and all developed Nautilus components realized during the program.

5.3.0 Approach

HMI will utilize its Nautilus software platform configured to operate on the MK20 Mod 0 vehicle. This will consist of first implementing WayFinder to detect and classify TOIs and localize them in reference to the sensor frame. Once the perception system has been established and validated, Helmsman will be deployed to the vehicle to expose telemetry and system controls to Commander and WayFinder for autonomous operation. With WayFinder and Helmsman deployed on the MK20 Mod 0, autonomous behaviors will be created in Commander to navigate to and interrogate TOI. The remaining effort will be implementing WaveLink to communicate with the vehicle after deployment. This acoustic communication link will serve as the link between the operator and vehicle for tasks that must be verified by a human-in-the-loop before action is executed by the vehicle.

5.3.1 Mine-Like Object Perception (Base Scope)

The initial effort in the Base Scope of work will be the data collection of mine-like objects provided by the customer [SOW 4.2, 4.3]. Once this data is collected and initial models are created, HMI will then implement these models within WayFinder and will focus on performance considerations for future on-hardware development.

Initial model creation can suffer from 2 different fitting issues: underfitting and overfitting. Underfitting occurs when the model for classification is too simple and cannot identify the underlying trend of the training sets. Overfitting occurs when the model for classification has been trained with a substantial volume of data where the algorithm begins to consider the noise and inaccuracies in the training sets as valid data. These two fitting issues are well understood by HMI and procedures have been established to follow when collecting initial training sets. These procedures consist of varying the angles of observation, creating skewed and partial measurements, and ensuring that enough variety of representations exist in both the training and test data sets. With this abundance of data, fitting issues will be minimized by ensuring variety in observations and providing adequate training and testing data sets.

Once high-quality data is collected for training, the data will be processed in Hypnos. In the Hypnos pipeline, data sets are labeled, and parameters of a convolutional neural network (CNN) are specified. Additionally, synthetic data is generated from CAD models provided of the objects of interest. This synthetic data is then programmatically altered to create a rich data set for training and testing of the generated model.

Once the processing pipeline is established and vetted, HMI will validate the algorithms and record initial fit metrics. This will take place in both pool and open water locations to ensure that no one modality is biased in the development process.

Evaluation of the models generated during the initial data collection event will inform the optimal arrangement of the sensors. At follow on data collection events, HMI will mount a Numurus 3DX-C Smart Sensor and a Blueprint Subsea Oculus 750D on a VideoRay Defender vehicle for baselining the accuracy of the models. Mounting the sensors on a vehicle allows for evaluation of the robustness of the model's ability to detect objects with motion experienced in deployment. During the data collection period, the existing models will be executed to determine their accuracy and further characterize the performance of the

algorithm against the metrics of evaluation provided in SOW 4.4.1. Evaluating the performance of the current models, false positives and missed detections will further refine features of detection and update the training sets accordingly.

As stated earlier, the ultimate objective of Phase I is to deploy WayFinder with the ability to detect and classify mine-like objects of known characteristics and determine both the distance and direction relative to the vehicle. The class, distance, and direction will be published to a data bus that complies with UMAA standards. As in the previous data collection event, HMI's demonstration will be executed with the sensors mounted on a surrogate vehicle. The operator will be provided a user interface that displays the sensed data, detection results, and pose estimation of objects of interest. Additionally, all pub/sub and services for the detected objects will be available for HMI's autonomy framework.

5.3.2 Untethered Autonomy (Option 1)

In order to achieve untethered autonomy, two distinct efforts must be undertaken: (1) implement a control system and autonomy framework that compensates for disturbances and uncertainties in the environment without the immediate intervention of an operator, and (2) implement a compute and energy solution onboard the MK20 Mod 0 that can enable transit and processing all sensor, control, and autonomy data.

5.3.2.1 Helmsman, Commander, and WaveLink

The typical approach taken with designing a controller for an AUV/ROV is to use a Proportional-Integral-Derivative (PID) feedback controller. For many situations a well-tuned PID controller can work sufficiently; however, the presence of the integral gain in the PID controller can be problematic when interacting with the environment or using payloads that constrain the vehicle's motion.

In the case of a vehicle equipped with a manipulator or payloads that constrain movement, the integral term of a PID may cause propulsor saturation because the propulsors are unable to move the anchored system. There are heuristics for handling integrator saturation, each of which add complexity to the tuning and have their own technical drawbacks. Integrators can be slow since it takes time for error to build up enough to result in vehicle motion. Alternative control methods, such as Model Predictive Control (MPC), do not rely on traditional feedback terms and, thus, are not susceptible to the problems associated with integral control. This is precisely why Helmsman employs an MPC for control.

Helmsman is largely agnostic to the underlying hardware platform both in theory and implementation. However, it does rely on reasonably known kinematic and dynamic models that, by definition, are specific to the vehicle and payload. HMI has completed initial estimation of the model parameters in simulation of the specified vehicle and will continue to refine the system throughout the course of this program. These initial parameters will be verified on hardware during the base scope of work. For Helmsman to be realized on hardware, a hardware abstraction layer (HAL) will be created for the existing MK20 Mod 0 system to access the propulsors and this layer will be exposed through Helmsman. Once integrated into Helmsman, these systems will be made available through UMAA compliant messages. This will ensure that, not only can the autonomy framework control the vehicle, but the existing operator interface is left unchanged. Once fully realized, all actuation (manipulation, propulsors, and payloads) will be available for use within behaviors implemented within Commander. Upon migration to a vehicle, additional work will be necessary for WayFinder to operate properly with the onboard hardware sensing package. An additional HAL will be created to access the sensors on board and to pass along state estimation data to WayFinder for world model generation. Once incorporated into WayFinder, this sensor data will be published on the data bus in UMAA compliant message format.

In order to accomplish the requirements of this option phase, behaviors will be created in Commander to accomplish desired functionality specified in SOW 4.11. The vehicle will be capable of executing search and survey patterns in specified areas, detect and classify TOIs, conduct in close inspection and validation of identification, and communicate its findings with an operator over an acoustic communication's link. Even with autonomy on board the vehicle, conditions exist where an operator is still desired to be involved in the outcome of an action or in order to validate data. In the absence of a tether, acoustic modems are utilized to establish a communications link which enables operator input. Acoustic modems are limited in throughput, typically transmitting data at speeds of 3kbps or slower. To compensate for that, Nautilus ensures that minimal amount of data needs to be exchanged to communicate, encapsulating the complexity of actions on board the vehicle and by utilizing existing libraries of TOIs. WaveLink will be implemented on board the MK20 Mod 0 in order to exchange data between operators and vehicle.

5.3.2.2 MK20 Mod 0 Vehicle Modifications

In order to facilitate tether-less operations of the MK20 Mod 0, several hardware upgrades to the platform will be accomplished through the option period. The two primary tasks are to install a battery module (both NiMH and Li-Ion varieties) and migrate the compute capabilities to a module onboard the vehicle. The implementation of these two capabilities, along with a Nautilus implementation, will result in a vehicle capable of operating tether-less.

VideoRay's NiMH solution is currently in testing and is moving to production. This capability will provide the vehicle with endurance of 1-3 hours and charge times of 4 hours. The Lithium-Ion variants are in the final stages of design and are being prepared for testing. HMI proposes that this program is used to accelerate the timeline of testing for certification in order realize the additional energy performance and capacity that can be gained over the available NiMH offering. The Lithium-Ion solution will provide 1.3-4 hours with charge times of only 2 hours. Expediting the certification of the Lithium-Ion batteries will ultimately increase the vehicle's available power and battery life expectancy over the NiMH offering. The current MK20 Mod 0 relies on a topside control station for all computation. For autonomy to be enabled for the system, a compute solution must be implemented. VideoRay will deliver a compute solution that is comprised of a Nvidia Xavier NX and upgraded networking capabilities, enhancing the network speed of 100mb/s to 1Gb/s. The Xavier is a System-on-Chip (SOC) that couples a GPU capable of 21TOPS to process the machine learning components of WayFinder and 6 Caramel ARM CPUs to execute the rest of the Nautilus software suite. In addition to the autonomy software, the compute module will execute system health and power system monitoring. These monitors will be advertised on the data bus in UMAA compliant messages.

5.3.3 Payload and Prototype Delivery (Option 2)

Incorporation of payloads are addressed through systematic approach of power, data, establishing a Helmsman compatible HAL, and finally behavior creation. With the flexibility of Helmsman to easily integrate new actuators and subsequent behaviors simple incremental advancements can be realized without software rework. HMI will establish a workflow with the customer to validate the new capabilities through validation in both simulation and real-world testing. HMI proposes that each evolution shall not exceed 3 months.

Upon successful completion of the previous option period, HMI and VideoRay will deliver 2 fully capable systems that can execute all behaviors and incorporate all payloads required throughout the program. HMI develops all software and robotic autonomous behaviors with the ability to be executed in simulation. This has resulted in a framework that allows both developers and operators to validate software in a way that truly obfuscates the knowledge if a physical system is being controlled or a simulated one. This same simulation framework will be delivered as a training tool for operators, in addition to the in-person training they will receive by our operators. Training

5.3.3 IP Assertions -See Attachment 4, Data Assertions List within the resultant Agreement.

6.0 Deliverable Schedule:

Paragraph Reference	Deliverable	Frequency	Due Date	Delivery Method
4.1.2	Integrated Master Schedule (IMS)	Once	Kickoff Meeting	Electronic
4.1.4	SUNet Access Roster	Once	Kickoff Meeting	Electronic
4.4.2	Object Detection & Tracking Algorithm	Once	NLT 5 Days Prior to Object Perception Demonstration	Electronic via SUNet
4.4.3	Labeled Object Perception Training Dataset	Once	NLT 5 Days Prior to Object Perception Demonstration	Electronic via SUNet
4.5.1	Monthly Report	Monthly	Monthly	Electronic via D12E
4.7.1	PDR	Once	28 Days AOE	Electronic via D12E
4.7.6	Object Perception Report	Once	At PDR	Electronic via SUNet
4.8.1	CDR	Once	88 Days AOE	Electronic via D12E
4.11.1	Complete Prototype Vehicle	Once	12 Months AOE	Physical to NIWC-PAC
4.12.1	Interface Control	Once	15 Months AOE	Electronic via D12E

Documentation				
4.14.2	UMMA Compliance Report	Once	15 Months AOE	Electronic via D12E
4.15.2	ATR Expansion 1 – Labeled Dataset	Once	3 Months AOE	Electronic via SUNet
4.16.2	ATR Expansion 2 – Labeled Dataset	Once	3 Months AOE	Electronic via SUNet
4.17.2	ATR Expansion 3 – Labeled Dataset	Once	3 Months AOE	Electronic via SUNet
4.18.1	Neutralization Payload Spiral Upgrades	Once	TBD	Physical to NIWC-PAC
4.26.5	Two (2) Prototypes Delivery	Once	TBD	Physical to NIWC-PAC
4.27.1	Operator & Maintainer Training	Once	TBD	Physical to NIWC-PAC

7.0 MILESTONE SCHEDULE

Milestone	Task Number	Milestone Description
1	4.1	Kick-off Meeting
2	4.2	Data Collection Event 1
3	4.3	Data Collection Event 2
4	4.4	Object Perception Demonstration
5	4.5	Monthly Reporting
6	4.6	Bi-Weekly Update Calls
7	4.7	Preliminary Design Review
8	4.8	Critical Design Review
9	4.9	Hardware-in-the-Loop Demonstration
10	4.10	Tethered Autonomy Demonstration
11	4.11	Untethered Autonomy Demonstration 1
12	4.12	Interface Control Document Delivery
13	4.13	Environmental Testing Support
14	4.14	UMMA Compliance Report Delivery
15	4.15	ATR Expansion 1
16	4.16	ATR Expansion 2
17	4.17	ATR Expansion 3
18	4.18	Untethered Demonstration 2
19	4.19	Sensor Payload Integration 1
20	4.20	Sensor Payload Integration 2
21	4.21	Sensor Payload Integration 3
22	4.22	Communication Payload Integration 1
23	4.23	Engineering Services 1
24	4.24	Engineering Services 2
25	4.25	Engineering Services 3
26	4.26	Two (2) Prototypes Delivery
27	4.27	Operator & Maintainer Training

7.0 DATE OF COMPLETION. The Date of Completion for this Agreement is twenty-four (24) months after the date of award, as depicted in block 3, of the SF 26, or as otherwise determined by the Agreements Officer.

8.0 PLACE OF PERFORMANCE:

8.1 TRANSDEC

- 420 Transdec Rd
San Diego, CA 92106
- 8.2 Houston Mechatronics
17146 Feather Craft Ln #450
Webster, TX 77598
- 8.3 Houston Mechatronics – Lake Travis
20811 Dawn Dr. #604
Lago Vista, TX 78645

9.0 GOVERNMENT FURNISHED EQUIPMENT/INFORMATION/PERSONNEL:

SOW Ref	Date Required	Description
Task 2 4.2.1 - 4.2.4	Within 30 days of contract	Digital file of Mine Like Object Access to surrogate Mine Like Object shape for data collection Access to TRANSDEC for data collection event 1
Task 3 4.3.1 - 4.3.3	NLT 30 days before demonstration	Access to surrogate Mine Like Object shape for data collection Access to TRANSDEC for data collection event 2
Task 4 4.4.1 - 4.4.4	Within 4 months of contract	Access to surrogate Mine Like Object shape for demonstration Access to TRANSDEC for demonstration
Task 10 4.10.2 - 4.10.4	NLT 8 months AOE	Access to surrogate Mine Like Objects for demonstration Access to TRANSDEC for demonstration Access to PIER for demonstration
Task 11 4.11.1 - 4.11.2	NLT 12 months AOE	Access to surrogate Mine Like Objects for demonstration Access to TRANSDEC for demonstration Access to PIER for demonstration
Task 15 4.15.1 - 4.15.2	NLT 1 week AOE	Digital file of Mine Like Objects Access to surrogate Mine Like Objects shapes for data collection Access to TRANSDEC and PIER for expansion 1 data collection
Task 16 4.16.1 - 4.16.2	NLT 5 weeks AOE	Digital file of Mine Like Objects Access to surrogate Mine Like Objects shapes for data collection Access to TRANSDEC and PIER for expansion 2 data collection
Task 17 4.17.1 - 4.17.2	NLT 9 weeks AOE	Digital file of Mine Like Objects Access to surrogate Mine Like Objects shapes for data collection Access to TRANSDEC and PIER for expansion 3 data collection
Task 18 4.18.1 - 4.18.4	NLT 1 week AOE O2	Digital files of Neutralization Payload Access to Neutralization Payload for electromechanical interface validation. Equipment actuation checkout Drawings of electromechanical interfaces to Neutralization Payload Interface documentation of Neutralization Payload
Task 19 4.19.1-4.19.4	TBD	Digital files of Alternate Sensor Payload Access to Alternate Sensor Payload for electromechanical interface validation. Equipment operation checkout Drawings of electromechanical interfaces to Alternate Sensor



		Payload Interface documentation of Alternate Sensor Payload
Task 20 4.20.1-4.20.4	TBD	Digital files of Alternate Sensor Payload Access to Alternate Sensor Payload for electromechanical interface validation. Equipment operation checkout Drawings of electromechanical interfaces to Alternate Sensor Payload Interface documentation of Alternate Sensor Payload
Task 21 4.21.1-4.21.4	TBD	Digital files of Alternate Sensor Payload Access to Alternate Sensor Payload for electromechanical interface validation. Equipment operation checkout Drawings of electromechanical interfaces to Alternate Sensor Payload Interface documentation of Alternate Sensor Payload
Task 22 4.22.1 - 4.22.4	TBD	Digital files of Alternate Communications Payload Access to Alternate Communications Payload for electromechanical interface validation. Equipment operation checkout Drawings of electromechanical interfaces to Alternate Communications Payload Interface documentation of Alternate Communications Payload

10.0 SECURITY:

10.1

11.0 ACCEPTANCE CRITERIA AND SUCCESS METRICS:

The Autonomous EOD Maritime Response Vehicle effort seeks to prototype a system capable of detecting, identifying, localizing, navigating to, inspecting, and neutralizing mine-like objects on the seafloor, in the water column. A successful prototype system is characterized through the following criteria:



[REDACTED]

[REDACTED]

[REDACTED]

[REDACTED]

[REDACTED]

[REDACTED]

[REDACTED]

[REDACTED]

[REDACTED]

[REDACTED]

[REDACTED]

[REDACTED]

12.0 INTELLECTUAL PROPERTY/DATA RIGHTS:

12.1 All proposed Non-Commercial and/or Commercial Intellectual property associated with the systems shall be addressed in Attachment 4: Data Assertions List and Attachment 5, EULA of the DIU Other Transaction Agreement, Terms and Conditions.

12.2 For purposes of data developed under this Agreement for prototype purposes, the Government shall have Government Purpose Rights (GPR). This expressly includes data collected for the purposes of training object detection & tracking algorithms, and any associated training data both real and synthetic.

ATTACHMENT 2: WIDE AREA WORKFLOW INSTRUCTIONS

A. Payments will be made by the Defense Finance and Accounting Service office, as indicated below, within thirty (30) calendar days of an accepted invoice in the government provided invoicing and payment system.



[REDACTED]

B. Unless otherwise stated, the COMPANY is required to utilize the Wide Area Work Flow (WAWF) system when processing invoices and receiving reports under this Agreement. WAWF is a secure web-based system for electronic invoicing, receipt and acceptance. WAWF application enables electronic form submission of invoices, Government inspection, and acceptance documents in order to support DoD's goal of moving to a paperless acquisition process. Authorized DoD users are notified of pending actions by e-mail and are presented with a collection of documents required to process the contracting or financial action. It uses Public Key Infrastructure (PKI) to electronically bind the digital signature to provide non-reputable proof that the user electronically signed the document with the contents. Benefits include online access and full spectrum view of document status, minimized re-keying and improving data accuracy, eliminating unmatched disbursements and making all documentation required for payment easily accessible. The COMPANY shall:

1. Ensure an Electronic Business Point of Contact is designated within the System for Award Management at <http://www.sam.gov>.
2. Register to use WAWF-RA at the <https://wawf.eb.mil> site. Step-by-step procedures to register are available at the <https://wawf.eb.mil> site. The COMPANY is directed to use the "2-N-1" invoice format when processing invoices.
3. Document routing. The COMPANY shall use the information in the Routing Data Table below only to fill inapplicable fields in WAWF when creating payment requests and receiving reports in the system.

ROUTING DATA TABLE

[REDACTED]	[REDACTED]
[REDACTED]	[REDACTED]
[REDACTED]	[REDACTED]
[REDACTED]	[REDACTED]
[REDACTED]	[REDACTED]
[REDACTED]	[REDACTED]
[REDACTED]	[REDACTED]
[REDACTED]	[REDACTED]
[REDACTED]	[REDACTED]
[REDACTED]	[REDACTED]

■ Payment request and supporting documentation. The COMPANY shall ensure a payment request includes appropriate line item and subline item descriptions of the work performed as detailed in the SOW for specific milestones.

D. WAWF email notifications. The COMPANY shall enter the email address identified below in the "Send Additional Email Notifications" field of WAWF once a document is submitted in the system.

DIU Invoices: [REDACTED]

Agreements Officer Representative as defined in Attachment 3

E. The COMPANY may obtain clarification regarding invoicing in WAWF from the following contracting activity's administrative WAWF point of contact. For technical WAWF help, contact the WAWF help desk at 866-618-5988.

F. The following guidance is provided for invoicing processed under this Agreement through WAWF:

1. The AOR identified in Attachment 3, "Agreement Administration" shall continue to formally inspect and accept the deliverables/milestones. To the maximum extent practicable, the AOR shall review the deliverable(s) milestone report(s) and either:

a. provide a written notice of rejection to the COMPANY which includes feedback regarding deficiencies requiring correction or

b. written notice of acceptance to the AO.

2. Acceptance within the WAWF system shall be performed by the DIU Financial Management team upon receipt of a confirmation email, or other form of transmittal, from the AOR.

3. The COMPANY agrees, when entering invoices entered in WAWF to utilize the contract line item number (CLIN) (please use 000I) and accounting classification reference number (ACRN) associated with each milestone as detailed in Section B. The description of the CLIN shall include reference to the associated milestone number along with other necessary descriptive information. The COMPANY agrees that the Government may reject invoices not submitted in accordance with this provision.

G. Note for DFAS: The Agreement shall be entered into the DFAS system by CLIN - Milestone association (MS)/ACRN as delineated in Section B. The Agreement is to be paid out by CLIN (MS)/ACRN. Payments shall be made using the CLIN (MS)/ACRN association as delineated at Section B.

H. Payee Information: As identified at Central Contractor Registration, i.e., Commercial and Government Entity (CAGE) Code, Dun & Bradstreet number (DUNS), and Tax Identification Number (TIN). Payments shall be made in the amounts set forth in the SOW, provided the AOR has verified the completion of the milestones.

ATTACHMENT 3: AGREEMENT ADMINISTRATION

Below is a list of the Points of Contact for the COMPANY and the Government. Each Party may change its representatives named below by written notification to the other party. The Government will affect the change following the procedures in Article II, subparagraph C.3. of the main text of the Agreement.

A. Government Points of Contact:

[REDACTED]

[REDACTED]

[REDACTED]



B. COMPANY's Points of Contact

Program Manager:

Name: Charles Blakely
 Phone: 832.729.0787
 Email: cblakely@houstonmechatronics.com

Administrative/Contracting:

Name: Reg B. Berka, Chief Operating Officer
 Phone: 281.942.9069
 Email: rberka@houstonmechatronics.com

ATTACHMENT 4: DATA ASSERTIONS LIST

In accordance with Article 10 - Data Rights, Houston Mechatronics Inc is asserting data rights on Non-commercial Technical Data or Computer Software. The Government's rights to use, release, or disclose the following technical data or computer software should be restricted as shown below:

Non-Commercial Technical Data/Computer Software/Patents to be Furnished With Restrictions**	Basis for Assertion***	Asserted Rights Preference****	Name or Person Asserting Restrictions*****
HMI Nautilus Software Commander Wavelink Helmsman Wayfinder Loggerhead Reef Shipyard Minnow Manipulation autonomy software Sortie Manager Perception Processing World Model Hypnos Vehicle Simulation System	Developed exclusively under private expense	Commercial subject to EULA	Houston Mechatronics, Inc.
*Note: Commercial license rights as specified in Article 10 - Data Rights, and the COMPANY End User License Agreement (EULA) attached hereto as Attachment 4.			

The software stack inserted in the table above was developed to support our commercial product Aquanaut 100% under private expense. HMI does not anticipate changes to compiled software to support this program. The prototype vehicle is delivered with a perpetual evaluation license that allows for operation of the vehicle. The cost of the license(s) is included in tasks 4.11 and 4.26, as referenced in the Statement of Work.

Patents

The following patents may be applicable to this scope of work:
 Patent Number: US Patent Application 15/449,803
 Title: RE-CONFIGURABLE SUBSEA ROBOT

Inventor name(s): Nicolas Radford, John Yamokoski, and Chad Tobler
Assignee: Houston Mechatronics, Inc
Filing Date: March 3, 2017

ATTACHMENT 5: EULA

**HOUSTON MECHATRONICS
SOFTWARE END USER LICENSE AGREEMENT**

THIS SOFTWARE END USER LICENSE AGREEMENT, including the Order Form which by this reference is incorporated herein (this "**Agreement**"), is a binding agreement between **HOUSTON MECHATRONICS, INC.**, having an address of 17146 Feathercraft Lane, Webster, Texas 77598 ("**Licensor**"), and the person or entity identified on the Order Form as the licensee of the Software ("**Licensee**").

LICENSOR PROVIDES THE SOFTWARE SOLELY ON THE TERMS AND CONDITIONS SET FORTH IN THIS AGREEMENT AND ON THE CONDITION THAT LICENSEE ACCEPTS AND COMPLIES WITH THEM. BY ORDERING THE SOFTWARE YOU (A) ACCEPT THIS AGREEMENT AND AGREE THAT LICENSEE IS LEGALLY BOUND BY ITS TERMS; AND (B) REPRESENT AND WARRANT THAT: (I) YOU ARE OF LEGAL AGE TO ENTER INTO A BINDING AGREEMENT; AND (II) IF LICENSEE IS A CORPORATION, GOVERNMENTAL ORGANIZATION, OR OTHER LEGAL ENTITY, YOU HAVE THE RIGHT, POWER, AND AUTHORITY TO ENTER INTO THIS AGREEMENT ON BEHALF OF LICENSEE AND BIND LICENSEE TO ITS TERMS. IF LICENSEE DOES NOT AGREE TO THE TERMS OF THIS AGREEMENT, LICENSOR WILL NOT AND DOES NOT LICENSE THE SOFTWARE TO LICENSEE AND YOU MUST NOT USE THE SOFTWARE OR DOCUMENTATION.

NOTWITHSTANDING ANYTHING TO THE CONTRARY IN THIS AGREEMENT OR YOUR OR LICENSEE'S ACCEPTANCE OF THE TERMS AND CONDITIONS OF THIS AGREEMENT, NO LICENSE IS GRANTED (WHETHER EXPRESSLY, BY IMPLICATION, OR OTHERWISE) UNDER THIS AGREEMENT, AND THIS AGREEMENT EXPRESSLY EXCLUDES ANY RIGHT, CONCERNING ANY SOFTWARE THAT LICENSEE DID NOT ACQUIRE LAWFULLY OR THAT IS NOT A LEGITIMATE, AUTHORIZED COPY OF LICENSOR'S SOFTWARE.

I. Definitions. For purposes of this Agreement, the following terms have the following meanings:

"**Authorized Users**" means the following individual persons authorized to use the Software pursuant to the license granted under this Agreement: employees of Licensee and any contractors or agents of Licensee using the Software on behalf of Licensee.

"**Documentation**" means user manuals, technical manuals, and any other materials provided by Licensor, in printed, electronic, or other form, that describe the installation, operation, use, or technical specifications of the Software.

"**Intellectual Property Rights**" means any and all registered and unregistered rights granted, applied for, or otherwise now or hereafter in existence under or related to any patent, copyright, trademark, trade secret, database protection, or other intellectual property rights laws, and all similar or equivalent rights or forms of protection, in any part of the world.

"**Licensee**" has the meaning set forth in the preamble.

"**License Fees**" means the license fees, including all taxes thereon, paid or required to be paid by Licensee for the license granted under this Agreement, and as designated on the Order Form.

"**Licensor**" has the meaning set forth in the preamble.

"**Order Form**" means the order form filled out and submitted by or on behalf of Licensee, and accepted by Licensor, for Licensee's purchase of the license for the Software granted under this Agreement.

"**Person**" means an individual, corporation, partnership, joint venture, limited liability company, governmental authority, unincorporated organization, trust, association, or other entity.

“**Software**” means the software programs for which Licensee is purchasing a license, as expressly set forth in the Order Form.

“**Term**” has the meaning set forth in Section 11.

“**Third Party**” means any Person other than Licensee or Licensor.

“**Update**” means updates, bug fixes, patches, and other error corrections as Licensor may make generally available to licensees of the Software then entitled to maintenance and support services, such services provided under a separate set of terms and conditions which may be included with, and incorporated into, the Order Form.

2. License Grant and Scope. Subject to and conditioned upon Licensee’s payment of the License Fees and Licensee’s strict compliance with all terms and conditions set forth in this Agreement, Licensor hereby grants to Licensee a non-exclusive, non-transferable, non-sublicensable, limited license during the Term to use, solely by and through its Authorized Users, the Software and Documentation, solely as set forth in this Section 2 and subject to all conditions and limitations set forth in Section 11 or elsewhere in this Agreement. This license grants Licensee the right, exercisable solely by and through Licensee’s Authorized Users, to:

(a) Use and run the Software as properly installed in accordance with this Agreement and the Documentation, solely as set forth in the Documentation and solely for Licensee’s internal business purposes. Such use is permitted only on the computer hardware designated on the Order Form on which the Software is installed, and owned or leased, and controlled by, Licensee.

(b) Download or otherwise make copies of the Documentation and use such Documentation, solely in support of its licensed use of the Software in accordance herewith. All copies of the Documentation made by Licensee (i) will be the exclusive property of Licensor; (ii) will be subject to the terms and conditions of this Agreement; and (iii) must include all trademark, copyright, patent, and other Intellectual Property Rights notices contained in the original.

3. Third-Party Materials. The Software may include software, content, data, or other materials, including related documentation, that are owned by Persons other than Licensor and that are provided to Licensee on licensee terms that are in addition to and/or different from those contained in this Houston Mechatronics Software End User License Agreement (“**Third-Party Licenses**”). A list of all materials, if any, included in the Software and provided under Third-Party Licenses is set forth on Schedule A to this Agreement, and the applicable Third-Party Licenses are accessible via links therefrom. Licensee is bound by and shall comply with all Third-Party Licenses. Any breach by Licensee or any of its Authorized Users of any Third-Party License is also a breach of this Agreement.

4. Use Restrictions. Licensee shall not, and shall require its Authorized Users not to, directly or indirectly:

(a) use (including make any copies of) the Software or Documentation beyond the scope of the license granted under Section 2;

(b) provide any other Person, including any subcontractor, independent contractor, affiliate, or service provider of Licensee, with access to the Software or Documentation, provided that Authorized Users may use the Software;

(c) reverse engineer, disassemble, decompile, decode, or otherwise attempt to derive or gain access to the source code of the Software or any part thereof;

(d) remove, delete, alter, or obscure any trademarks or any copyright, trademark, patent, or other intellectual property or proprietary rights notices provided on or with the Software or Documentation, including any copy thereof;

(e) copy the Software or Documentation, in whole or in part;

(f) rent, lease, lend, sell, sublicense, assign, distribute, publish, transfer, or otherwise make available the Software, or any features or functionality of the Software, to any Third Party for any reason, whether or not over a network or on a hosted basis, including in connection with the internet or any web hosting, wide area network (WAN), virtual private network (VPN), virtualization, time-sharing, service bureau, software as a service, cloud, or other technology or service;

(g) use the Software or Documentation in, or in association with, the design, construction, maintenance, or operation of any hazardous environments or systems, for which it is

not designed, including (i) power generation systems; (ii) aircraft navigation or communication systems, or air traffic control systems; and (iii) safety-critical applications, including medical or life-support systems;

(h) use the Software or Documentation in violation of any law, regulation, or rule; or

(i) use the Software or Documentation for purposes of competitive analysis of the Software, the development of a competing software product or service, or any other purpose that is to the Licensor's commercial disadvantage.

5. Responsibility for Use of Software. Licensee is responsible and liable for all uses of the Software and Documentation through access thereto provided by Licensee, directly or indirectly. Specifically, and without limiting the generality of the foregoing, Licensee is responsible and liable for all actions and failures to take required actions with respect to the Software and Documentation by its Authorized Users or by any other Person to whom Licensee or an Authorized User may provide access to or use of the Software and/or Documentation, whether such access or use is permitted by or in violation of this Agreement.

6. Maintenance and Support. Maintenance and support for the Software shall be provided under a separate set of terms and conditions which may be included with, and incorporated into, the Order Form and the associated Exhibit related thereto.

7. Collection and Use of Information.

(a) Licensee acknowledges that Licensor may, directly or indirectly through the services of Third Parties, collect and store information regarding use of the Software and about equipment on which the Software is installed or through which it otherwise is accessed and used, through (i) the provision of maintenance and support services; and (ii) security measures included in the Software as described in Section **Error! Reference source not found.**

(b) Licensee agrees that the Licensor may use such information for any purpose related to any use of the Software by Licensee or on Licensee's equipment, including but not limited to (i) improving the performance of the Software or developing Updates; and (ii) verifying Licensee's compliance with the terms of this Agreement and enforcing the Licensor's rights, including all Intellectual Property Rights in and to the Software.

8. Intellectual Property Rights. – See below, and Article 12.0 Intellectual Property/Data Rights, in Agreement No. HQ0845-21-9-0031.

9. Licensee acknowledges and agrees that the Software and Documentation are provided under license, and not sold, to Licensee. Licensee does not acquire any ownership interest in the Software or Documentation under this Agreement, or any other rights thereto, other than to use the same in accordance with the license granted and subject to all terms, conditions, and restrictions under this Agreement. Licensor reserves and shall retain its entire right, title, and interest in and to the Software and all Intellectual Property Rights arising out of or relating to the Software, except as expressly granted to the Licensee in this Agreement. Licensee shall safeguard all Software (including all copies thereof) from infringement, misappropriation, theft, misuse, or unauthorized access. Licensee shall promptly notify Licensor if Licensee becomes aware of any infringement of the Licensor's Intellectual Property Rights in the Software and fully cooperate with Licensor in any legal action taken by Licensor to enforce its Intellectual Property Rights.

10. PAYMENT. – See Article 5, Obligation and Payment in Agreement No. HQ0845-21-9-0031.

11. Term and Termination – See Article 3, Term of the Agreement and Termination in Agreement No. HQ0845-21-9-0031.

12. Limited Warranties, Exclusive Remedy, and Disclaimer/Warranty Disclaimer – See Article 11, Software License in Agreement No. HQ0845-21-9-0031.

(a) Solely with respect to Software for which Licensor receives a License Fee, Licensor warrants that, for a period of thirty (30) days following the license date set forth on the Order Form, the Software will substantially contain the functionality described in the Documentation, and when properly installed on the authorized hardware set forth on the Order Form, or on a computer

meeting the specifications set forth in, and operated in accordance with, the Documentation (if no specific authorized hardware is designated on the Order Form), will substantially perform in accordance therewith.

THE FOREGOING WARRANTY DOES NOT APPLY, AND LICENSOR STRICTLY DISCLAIMS ALL WARRANTIES, WITH RESPECT TO ANY THIRD-PARTY MATERIALS.

(b) The warranty set forth in Section 12(a) will not apply and will become null and void if Licensee breaches any material provision of this Agreement, or if Licensee, any Authorized User, or any other Person provided access to the Software by Licensee or any Authorized User, whether or not in violation of this Agreement, (i) installs or uses the Software on or in connection with any hardware or software not specified in the Order Form or Documentation (as applicable); (ii) modifies or damages the Software, or the media on which it is provided, including abnormal physical or electrical stress; or (iii) misuses the Software, including any use of the Software other than as specified in the Documentation.

(c) If, during the period specified in Section 12(a), any Software covered by the warranty set forth in such Section fails to perform substantially in accordance with the Documentation, and such failure is not excluded from warranty pursuant to the Section 12(b), Licensor will, subject to Licensee's promptly notifying Licensor in writing of such failure, at its sole option, either (i) repair or replace the Software, provided that Licensee provides Licensor with all information Licensor requests to resolve the reported failure, including sufficient information to enable the Licensor to recreate such failure; or (ii) refund the License Fees paid for such Software, subject to Licensee's ceasing all use of and, if requested by Licensor, returning to Licensor all copies of the Software.

If Licensor repairs or replaces the Software, the warranty will continue to run from the initial date specified on the Order Form, and not from Licensee's receipt of the repair or replacement. The remedies set forth in this Section 12(c) are Licensee's sole remedies and Licensor's sole liability under the limited warranty set forth in Section 12(a).

(d) EXCEPT FOR THE LIMITED WARRANTY SET FORTH IN SECTION 12(a), THE SOFTWARE AND DOCUMENTATION ARE PROVIDED TO LICENSEE "AS IS" AND WITH ALL FAULTS AND DEFECTS WITHOUT WARRANTY OF ANY KIND. ALL FUTURE SUPPORT AND MAINTENANCE FOR THE SOFTWARE SHALL BE PROVIDED TO LICENSEE, IF SELECTED AND PAID FOR BY LICENSEE, UNDER SEPARATE TERMS AND CONDITIONS WHICH MAY BE INCLUDED WITH, AND INCORPORATED INTO, THE ORDER FORM AND THE ASSOCIATED EXHIBIT RELATED THERETO.

TO THE MAXIMUM EXTENT PERMITTED UNDER APPLICABLE LAW, LICENSOR, ON ITS OWN BEHALF AND ON BEHALF OF ITS AFFILIATES AND ITS AND THEIR RESPECTIVE LICENSORS AND SERVICE PROVIDERS, EXPRESSLY DISCLAIMS ALL WARRANTIES, WHETHER EXPRESS, IMPLIED, STATUTORY, OR OTHERWISE, WITH RESPECT TO THE SOFTWARE AND DOCUMENTATION, INCLUDING ALL IMPLIED WARRANTIES OF MERCHANTABILITY, FITNESS FOR A PARTICULAR PURPOSE, TITLE, AND NON-INFRINGEMENT, AND WARRANTIES THAT MAY ARISE OUT OF COURSE OF DEALING, COURSE OF PERFORMANCE, USAGE, OR TRADE PRACTICE. WITHOUT LIMITATION TO THE FOREGOING, THE LICENSOR PROVIDES NO WARRANTY OR UNDERTAKING, AND MAKES NO REPRESENTATION OF ANY KIND THAT THE LICENSED SOFTWARE WILL MEET THE LICENSEE'S REQUIREMENTS, ACHIEVE ANY INTENDED RESULTS, BE COMPATIBLE, OR WORK WITH ANY OTHER SOFTWARE, APPLICATIONS, SYSTEMS, OR SERVICES, OPERATE WITHOUT INTERRUPTION, MEET ANY PERFORMANCE OR RELIABILITY STANDARDS OR BE ERROR FREE, OR THAT ANY ERRORS OR DEFECTS CAN OR WILL BE CORRECTED.

13. Limitation of Liability – See Article 19: Indemnity of Agreement No. HQ0845-21-9-0031

14. Export Regulation. The Software and Documentation may be subject to US export control laws, including the Export Control Reform Act and its associated regulations. The Licensee shall not, directly or indirectly, export, re-export, or release the Software or Documentation to, or make the Software or Documentation accessible from, any jurisdiction or country to which export, re-export, or release is prohibited by law, rule, or regulation. The Licensee shall comply with all applicable federal laws, regulations, and rules, and complete all required undertakings (including obtaining any necessary export license or other

governmental approval), prior to exporting, re-exporting, releasing, or otherwise making the Software or Documentation available outside the US.

15. US Government Rights. The Software is commercial computer software, as such term is defined in 48 C.F.R. §2.101. Accordingly, if the Licensee is the US Government or any contractor therefor, Licensee shall receive only those rights with respect to the Software and Documentation as are granted to all other end users under license, in accordance with (a) 48 C.F.R. §227.7201 through 48 C.F.R. §227.7204, with respect to the Department of Defense and their contractors, or (b) 48 C.F.R. §12.212, with respect to all other US Government licensees and their contractors.

16. Miscellaneous – See Article 23: Miscellaneous of Agreement No. HQ0845-21-9-0031

(a) Licensor will not be responsible or liable to Licensee, or deemed in default or breach hereunder by reason of any failure or delay in the performance of its obligations hereunder where such failure or delay is due to strikes, labor disputes, civil disturbances, riot, rebellion, invasion, epidemic, hostilities, war, terrorist attack, embargo, natural disaster, acts of God, flood, fire, sabotage, fluctuations or non-availability of electrical power, heat, light, air conditioning, or Licensee equipment, loss and destruction of property, or any other circumstances or causes beyond Licensor's reasonable control.

(b) All notices, requests, consents, claims, demands, waivers, and other communications hereunder shall be in writing and shall be deemed to have been given: (i) when delivered by hand (with written confirmation of receipt); (ii) when received by the addressee if sent by a nationally recognized overnight courier (receipt requested); (iii) on the third day after the date mailed, by certified or registered mail, return receipt requested, postage prepaid. Such communications must be sent to the respective parties at the addresses set forth on the Order Form (or to such other address as may be designated by a party from time to time in accordance with this Section 16(b)).

(c) Licensee shall not assign or otherwise transfer any of its rights, or delegate or otherwise transfer any of its obligations or performance, under this Agreement, in each case whether voluntarily, involuntarily, by operation of law, or otherwise, without Licensor's prior written consent, which consent Licensor may give or withhold in its sole discretion. For purposes of the preceding sentence, and without limiting its generality, any merger, consolidation, or reorganization involving Licensee (regardless of whether Licensee is a surviving or disappearing entity) will be deemed to be a transfer of rights, obligations, or performance under this Agreement for which Licensor's prior written consent is required. No delegation or other transfer will relieve Licensee of any of its obligations or performance under this Agreement. Any purported assignment, delegation, or transfer in violation of this Section 16(c) is void. Licensor may freely assign or otherwise transfer all or any of its rights, or delegate or otherwise transfer all or any of its obligations or performance, under this Agreement only if the Licensee's consent has provided written consent. This Agreement is binding upon and inures to the benefit of the parties hereto and their respective permitted successors and assigns.

(d) This Agreement is for the sole benefit of the parties hereto and their respective successors and permitted assigns and nothing herein, express or implied, is intended to or shall confer on any other Person any legal or equitable right, benefit, or remedy of any nature whatsoever under or by reason of this Agreement.

(e) This Agreement may only be amended, modified, or supplemented by an agreement in writing signed by each party hereto. No waiver by any party of any of the provisions hereof shall be effective unless explicitly set forth in writing and signed by the party so waiving. Except as otherwise set forth in this Agreement, no failure to exercise, or delay in exercising, any right, remedy, power, or privilege arising from this Agreement shall operate or be construed as a waiver thereof; nor shall any single or partial exercise of any right, remedy, power, or privilege hereunder preclude any other or further exercise thereof or the exercise of any other right, remedy, power, or privilege.

(f) If any term or provision of this Agreement is invalid, illegal, or unenforceable in any jurisdiction, such invalidity, illegality, or unenforceability shall not affect any other term or provision of this Agreement or invalidate or render unenforceable such term or provision in any other jurisdiction.

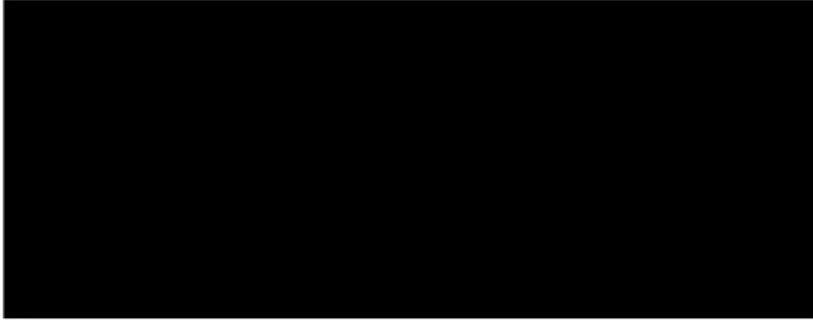
(g) For purposes of this Agreement, (a) the words "include," "includes," and "including" shall be deemed to be followed by the words "without limitation"; (b) the word "or" is not exclusive; and (c) the words "herein," "hereof," "hereby," "hereto," and "hereunder" refer to this Agreement as a whole. Unless the context otherwise requires, references herein: (x) to Sections, Annexes, Schedules, and Exhibits refer to the Sections of, and Annexes, Schedules, and Exhibits attached to, this Agreement; (y) to an agreement, instrument, or other document means such agreement, instrument, or other document as amended, supplemented, and modified from time to time to the extent permitted by the provisions thereof and (z) to a statute means such statute as amended from time to time and includes any successor legislation thereto and any regulations promulgated thereunder. This Agreement shall be construed without regard to any presumption or rule requiring construction or interpretation against the party drafting an instrument or causing any instrument to be drafted. The Order Form and all Annexes, Schedules, and Exhibits referred to herein shall be construed with, and as an integral part of, this Agreement to the same extent as if they were set forth verbatim herein.

(h) The headings in this Agreement are for reference only and do not affect the interpretation of this Agreement.

ATTACHMENT 6: AFFIRMATION OF BUSINESS STATUS CERTIFICATION

AFFIRMATION OF BUSINESS STATUS CERTIFICATION (ABSC)

Every significant participating entity shall complete the following table and provide a signature representing its certification.



The Entity named above represents that it is (check one of the following boxes):

- A Nontraditional Defense Contractor (NDC) – A Nontraditional Defense Contractor is an entity that is not currently performing and has not performed, for at least the one-year period preceding the solicitation of sources by DoD for the procurement or transaction, any contract or subcontract for the DoD that is subject to full coverage under the cost accounting standards prescribed pursuant to section 1502 of title 41 and the regulations implementing such section (see 10 U.S.C. 2302(9)).
- A Nonprofit Research Institution – As defined in 15 U.S.C. 3703 a nonprofit institution means an organization owned and operated exclusively for scientific or educational purposes, no part of the net earnings of which inures to the benefit of any private shareholder or individual; and includes federally funded research and development centers, as identified by the National Scientific Foundation in accordance with the government wide Federal Acquisition Regulation issued in accordance with section 1303(a)(1) of title 41 (or any successor regulation thereto).
- A Traditional Defense Contractor – A Traditional Defense Contractor is an entity that does not meet the definition of a Nontraditional Defense Contractor (NDC).

The undersigned hereby certifies that the representations made herein are accurate and true regarding the entity identified above. I authorize my electronic signature to carry the same weight and legal effect as my written signature.



ATTACHMENT 7: PROHIBITION ON USE OF CERTAIN TELECOMMUNICATIONS AND VIDEO SURVEILLANCE SERVICES OR EQUIPMENT

Prohibition on Use of Certain Telecommunications and Video Surveillance Services or Equipment

This attachment is to ensure compliance with Section 889 of the John S. McCain National Defense Authorization Act for Fiscal Year 2019 (Pub. L. 115-232). Based on the information provided below, the Government may be unable to enter into an Agreement, exercise an option under an Agreement, or bilaterally modify the Agreement to extend the term of an Agreement with the Company.

(a) *Definitions.*

Backhaul means intermediate links between the core network, or backbone network, and the small subnetworks at the edge of the network (e.g., connecting cell phones/towers to the core telephone network). Backhaul can be wireless (e.g., microwave) or wired (e.g., fiber optic, coaxial cable, Ethernet).

Covered foreign country means The People's Republic of China.

Covered telecommunications equipment or services means—

- (1) Telecommunications equipment produced by Huawei Technologies Company or ZTE Corporation (or any subsidiary or affiliate of such entities);
- (2) For the purpose of public safety, security of Government facilities, physical security surveillance of critical infrastructure, and other national security purposes, video surveillance and telecommunications equipment produced by Hytera Communications Corporation, Hangzhou Hikvision Digital Technology Company, or Dahua Technology Company (or any subsidiary or affiliate of such entities);
- (3) Telecommunications or video surveillance services provided by such entities or using such equipment; or
- (4) Telecommunications or video surveillance equipment or services produced or provided by an entity that the Secretary of Defense, in consultation with the Director of National Intelligence or the Director of the Federal Bureau of Investigation, reasonably believes to be an entity owned or controlled by, or otherwise connected to, the government of a covered foreign country.

Critical technology means—

- (1) Defense articles or defense services included on the United States Munitions List set forth in the International Traffic in Arms Regulations under subchapter M of chapter I of title 22, Code of Federal Regulations;
 - (2) Items included on the Commerce Control List set forth in Supplement No. 1 to part 774 of the Export Administration Regulations under subchapter C of chapter VII of title 15, Code of Federal Regulations, and controlled-
 - (i) Pursuant to multilateral regimes, including for reasons relating to national security, chemical and biological weapons proliferation, nuclear nonproliferation, or missile technology; or
 - (ii) For reasons relating to regional stability or surreptitious listening;
 - (3) Specially designed and prepared nuclear equipment, parts and components, materials, software, and technology covered by part 810 of title 10, Code of Federal Regulations (relating to assistance to foreign atomic energy activities);
 - (4) Nuclear facilities, equipment, and material covered by part 110 of title 10, Code of Federal Regulations (relating to export and import of nuclear equipment and material);
-

(5) Select agents and toxins covered by part 331 of title 7, Code of Federal Regulations, part 121 of title 9 of such Code, or part 73 of title 42 of such Code; or

(6) Emerging and foundational technologies controlled pursuant to section 1758 of the Export Control Reform Act of 2018 (50 U.S.C. 4817).

Interconnection arrangements means arrangements governing the physical connection of two or more networks to allow the use of another's network to hand off traffic where it is ultimately delivered (e.g., connection of a customer of telephone provider A to a customer of telephone company B) or sharing data and other information resources.

Reasonable inquiry means an inquiry designed to uncover any information in the entity's possession about the identity of the producer or provider of covered telecommunications equipment or services used by the entity that excludes the need to include an internal or third-party audit.

Roaming means cellular communications services (e.g., voice, video, data) received from a visited network when unable to connect to the facilities of the home network either because signal coverage is too weak or because traffic is too high.

Substantial or essential component means any component necessary for the proper function or performance of a piece of equipment, system, or service.

(b) *Prohibition.*

(1) The Company is prohibited from providing to the Government any equipment, system, or service that uses covered telecommunications equipment or services as a substantial or essential component of any system, or as critical technology as part of any system, unless the Company is providing (i) a service that connects to the facilities of a third-party, such as backhaul, roaming, or interconnection arrangements; or (ii) telecommunications equipment that cannot route or redirect user data traffic or permit visibility into any user data or packets that such equipment transmits or otherwise handles or the covered telecommunication equipment or services. A waiver, for a period not exceeding August 13, 2021, may be requested.

(2) The Company acknowledges and accepts that the Government is prohibited from entering into an agreement, or extending or renewing an agreement, with an entity that uses any equipment, system, or service that uses covered telecommunications equipment or services as a substantial or essential component of any system, or as critical technology as part of any system, unless an exception at paragraph (b)(1) of this article applies, regardless of whether that use is in performance of work under a Federal contract or agreement.

(c) *Certification.*

The Company shall review the list of excluded parties in the System for Award Management (SAM) (<https://www.sam.gov>) for entities excluded from receiving federal awards for "covered telecommunications equipment or services."

Based on that review:

(1) The Company certifies that it does **does not** provide covered telecommunications equipment or services as a part of its offered products or services to the Government in the performance of any contract, subcontract, other transaction agreement, or other contractual instrument.

(2) If the Company does provide covered telecommunications equipment or services as a part of its offered products or services to the Government in the performance of any contract, subcontract, other transaction agreement, or other contractual instrument as described in

paragraph (c)(1), the Company certifies that it will **will not** provide covered telecommunications equipment or services to the Government in the performance of any contract, subcontract, other transaction agreement, or other contractual instrument resulting from this solicitation. If the Company will provide covered telecommunications equipment or services to the Government in the performance of any contract, subcontract, other transaction agreement, or other contractual instrument resulting from this solicitation (c)(2), the Company shall provide the additional disclosure information required at paragraph (d)(1) of this Article.

(3) The Company certifies, after conducting a reasonable inquiry, for purposes of this certification, that it does **does not** use covered telecommunications equipment or services, or use any equipment, system, or service that uses covered telecommunications equipment or services. If the Company does use covered telecommunications equipment or services, or use any equipment, system, or service that uses covered telecommunications equipment or services as described under this paragraph (c)(3), the Company shall provide the additional disclosure information required at paragraph (d)(2) of this Article.

(d) *Disclosures.*

(1) Disclosure for the certification in paragraph (c)(2) of this Article. If the Company does provide covered telecommunications equipment or services to the Government in the performance of any contract, subcontract, other transaction agreement, or other contractual instrument in in paragraph (c)(2) of this provision, the Company shall provide the following information:

(i) For covered equipment—

(A) The entity that produced the covered telecommunications equipment (include entity name, unique entity identifier, CAGE code, and whether the entity was the original equipment manufacturer (OEM) or a distributor, if known);

(B) A description of all covered telecommunications equipment offered (include brand; model number, such as OEM number, manufacturer part number, or wholesaler number; and item description, as applicable); and

(C) Explanation of the proposed use of covered telecommunications equipment and any factors relevant to determining if such use would be permissible under the prohibition in paragraph (b)(1) of this Article.

(ii) For covered services—

(A) If the service is related to item maintenance: A description of all covered telecommunications services offered (include on the item being maintained: Brand; model number, such as OEM number, manufacturer part number, or wholesaler number; and item description, as applicable); or

(B) If not associated with maintenance, the Product Service Code (PSC) of the service being provided; and explanation of the proposed use of covered telecommunications services and any factors relevant to determining if such use would be permissible under the prohibition in paragraph (b)(1) of this Article.

(2) If the Company does use covered telecommunications equipment or services, or use any equipment, system, or service that uses covered telecommunications equipment or services in in paragraph (c)(3) of this Article, the Company shall provide the following information:

(i) For covered equipment—

(A) The entity that produced the covered telecommunications equipment (include entity name, unique entity identifier, CAGE code, and whether the entity was the OEM or a distributor, if known);

(B) A description of all covered telecommunications equipment offered (include brand; model number, such as OEM number, manufacturer part number, or wholesaler number; and item description, as applicable); and




(C) Explanation of the proposed use of covered telecommunications equipment and any factors relevant to determining if such use would be permissible under the prohibition in paragraph (b)(2) of this Article.

(ii) For covered services—

(A) If the service is related to item maintenance: A description of all covered telecommunications services offered (include on the item being maintained: Brand; model number, such as OEM number, manufacturer part number, or wholesaler number; and item description, as applicable); or

(B) If not associated with maintenance, the PSC of the service being provided; and explanation of the proposed use of covered telecommunications services and any factors



relevant to determining if such use would be permissible under the prohibition in paragraph (b)(2) of this Article.

(e) *Reporting requirement.*


(1) In the event the Company identifies covered telecommunications equipment or services used as a substantial or essential component of any system, or as critical technology as part of any system, during agreement performance, or the Company is notified of such by a subcontractor at any tier or by any other source, the Company shall report the information in paragraph (e)(2) of this Article to the Agreements Officer and to the Department of Defense website at <https://dibnet.dod.mil>.

(2) The Company shall report the following information pursuant to paragraph (e)(1) of this clause

(i) Within one business day from the date of such identification or notification: the agreement number; the order number(s), if applicable; supplier name; supplier unique entity identifier (if known); supplier Commercial and Government Entity (CAGE) code (if known); brand; model number (original equipment manufacturer number, manufacturer part number, or wholesaler number); item description; and any readily available information about mitigation actions undertaken or recommended.

(ii) Within 10 business days of submitting the information in paragraph (e)(2)(i) of this clause: any further available information about mitigation actions undertaken or recommended. In addition, the Company shall describe the efforts it undertook to prevent use or submission of covered telecommunications equipment or services, and any additional efforts that will be incorporated to prevent future use or submission of covered telecommunications equipment or services.

(e) *Subcontracts.* The Company shall insert the substance of this article, including this paragraph but excluding paragraph (b)(2), in all subcontracts and other contractual instruments, including subcontracts for the acquisition of commercial items.



(End of Summary of Changes)

AMENDMENT OF SOLICITATION/MODIFICATION OF CONTRACT			1. CONTRACT ID CODE	PAGE OF PAGES	
				1	3
2. AMENDMENT/MODIFICATION NO.	3. EFFECTIVE DATE	4. REQUISITION/PURCHASE REQ. NO.		5. PROJECT NO. (If applicable)	
	24-Jan-2022				
6. ISSUED BY	CODE	7. ADMINISTERED BY (If other than item 6)		CODE	
DEFENSE INNOVATION UNIT 230 RT JONES RD MOUNTAIN VIEW CA 94043	HQ0845	See Item 6			
8. NAME AND ADDRESS OF CONTRACTOR (No., Street, County, State and Zip Code)			9A. AMENDMENT OF SOLICITATION NO.		
HOUSTON MECHATRONICS, INC. HMI REGINALD B. BERKA 17146 FEATHERCRAFT LANE, STE 460 WEBSTER TX 77596-4304					
			9B. DATED (SEE ITEM 11)		
			[REDACTED] CONTRACT/ORDER NO.		
			10B. DATED (SEE ITEM 13)		
CODE 7LK31			X 30-Aug-2021		
FACILITY CODE					
11. THIS ITEM ONLY APPLIES TO AMENDMENTS OF SOLICITATIONS					
<input type="checkbox"/> The above numbered solicitation is amended as set forth in Item 14. The hour and date specified for receipt of offer <input type="checkbox"/> is extended, <input type="checkbox"/> is not extended.					
<p>Offer must acknowledge receipt of this amendment prior to the hour and date specified in the solicitation or as amended by one of the following methods:</p> <p>(a) By completing Items 8 and 15, and returning _____ copies of the amendment; (b) By acknowledging receipt of this amendment on each copy of the offer submitted; or (c) By separate letter or telegram which includes a reference to the solicitation and amendment numbers. FAILURE OF YOUR ACKNOWLEDGMENT TO BE RECEIVED AT THE PLACE DESIGNATED FOR THE RECEIPT OF OFFERS PRIOR TO THE HOUR AND DATE SPECIFIED MAY RESULT IN REJECTION OF YOUR OFFER. If by virtue of this amendment you desire to change an offer already submitted, such change may be made by telegram or letter, provided each telegram or letter makes reference to the solicitation and this amendment, and is received prior to the opening hour and date specified.</p>					
12. ACCOUNTING AND APPROPRIATION DATA (If required)					
See Schedule					
13. THIS ITEM APPLIES ONLY TO MODIFICATIONS OF CONTRACT ORDERS. IT MODIFIES THE CONTRACT/ORDER NO. AS DESCRIBED IN ITEM 14.					
A. THIS CHANGE ORDER IS ISSUED PURSUANT TO: (Specify authority) THE CHANGES SET FORTH IN ITEM 14 ARE MADE IN THE CONTRACT ORDER NO. IN ITEM 10A.					
B. THE ABOVE NUMBERED CONTRACT/ORDER IS MODIFIED TO REFLECT THE ADMINISTRATIVE CHANGES (such as changes in paying office, appropriation date, etc.) SET FORTH IN ITEM 14, PURSUANT TO THE AUTHORITY OF FAR 43.103(B).					
X C. THIS SUPPLEMENTAL AGREEMENT IS ENTERED INTO PURSUANT TO AUTHORITY OF: Agreement Article III, Paragraph B					
D. OTHER (Specify type of modification and authority)					
E. IMPORTANT: Contractor <input type="checkbox"/> is not, <input checked="" type="checkbox"/> is required to sign this document and return <u>1</u> copies to the issuing office.					
14. DESCRIPTION OF AMENDMENT/MODIFICATION (Organized by UCF section headings, including solicitation/contract subject matter where feasible.)					
Modification Control Number: [REDACTED]					
The Purpose of this modification is [REDACTED] fully funding Milestone 8.					
All other terms and conditions remain unchanged.					
Except as provided herein, all terms and conditions of the document referenced in Items 9A or 10A, as heretofore changed, remains unchanged and in full force and effect.					
15A. NAME AND TITLE OF SIGNER (Type or print)			16A. NAME AND TITLE OF CONTRACTING OFFICER (Type or print)		
Reginald B. Berka, Chief Operating Officer			[REDACTED]		
15B. CONTRACTOR/OFFEROR		15C. DATE SIGNED		16C. DATE SIGNED	
[Signature of Reginald B. Berka] (Signature of person authorized to sign)		January 26, 2022			

EXCEPTION TO SF 30
APPROVED BY OIRM 11-84

30-105-04

STANDARD FORM 30 (Rev. 10-83)
Prescribed by GSA
FAR (48 CFR) 53.243



SECTION SF 30 BLOCK 14 CONTINUATION PAGE

SUMMARY OF CHANGES

SECTION A - SOLICITATION/CONTRACT FORM

The total cost of this contract was increased by [REDACTED] from [REDACTED] to [REDACTED]

SECTION B - SUPPLIES OR SERVICES AND PRICES

SUBCLIN 0008AB

The option status has changed from Option to Option Exercised.

SECTION F - DELIVERIES OR PERFORMANCE

The following Delivery Schedule item for SUBCLIN 0008AB has been changed from:

DELIVERY DATE	QUANTITY	SHIP TO ADDRESS	DODAAC / CAGE
11-DEC-2021	1	N/A FOB: Destination	

To:

DELIVERY DATE	QUANTITY	SHIP TO ADDRESS	DODAAC / CAGE
30-SEP-2023	1	N/A FOB: Destination	

SECTION G - CONTRACT ADMINISTRATION DATA

Accounting and Appropriation

Summary for the Payment Office

As a result of this modification, the total funded amount for this document was increased by [REDACTED] from [REDACTED] to [REDACTED].

SUBCLIN 0008AB:

[REDACTED]
[REDACTED] has been added.





(End of Summary of Changes)



CERTAIN IDENTIFIED INFORMATION HAS BEEN EXCLUDED FROM THIS EXHIBIT BECAUSE IT IS BOTH NOT MATERIAL AND IS THE TYPE THAT THE REGISTRANT TREATS AS PRIVATE OR CONFIDENTIAL.

**APPROVED FOR PUBLIC
RELEASE, DISTRIBUTION
UNLIMITED**

**SUBCONTRACT AGREEMENT
COST PLUS FIXED FEE (Federal)**

SELLER: Houston Mechatronics, Inc.	SUBCONTRACT NO: [REDACTED]
ADDRESS: 17146 Feathercraft Lane Webster, TX 77598	DEFENSE PRIORITY ALLOCATION SYSTEM (DPAS) RATING: N/A
Attn: Reg Berka (281)-788-8462 e-mail: rberka@houstonmechatronics.com	ESTIMATED COST AND FEE: [REDACTED]

INTRODUCTION

This Subcontract, effective **August 10, 2021** is made between [REDACTED] (hereinafter known as [REDACTED] or "Buyer") and Houston Mechatronics, Inc. (hereinafter known as "Seller"). The work to be performed by Seller under this Subcontract will support [REDACTED] work under Prime Contract No. [REDACTED] that has been issued by [REDACTED]. The work defined in Attachment I (Statement of Work and Schedule) shall be performed on a Cost Plus Fixed Fee Completion basis in accordance with this Schedule A (Specific Terms and Conditions), and any document referenced herein.

SCHEDULE A - SPECIFIC TERMS AND CONDITIONS

1.0 PERIOD OF PERFORMANCE

The period of performance for this Subcontract is **8/10/2021** through **12/20/2022**, unless amended in writing by mutual agreement of the parties. Seller is not obligated to continue work or provide services and [REDACTED] is not obligated to compensate Seller for work performed or expenses incurred or committed before or after these dates.

Notwithstanding the foregoing, Seller is entitled to all reasonable, allowable, and allocable pre-Subcontract costs incurred in good faith in support of this effort beginning on **21 May 2021** through **August 10, 2021**. Upon bilateral execution of this Agreement, Seller shall submit an invoice to [REDACTED] for these pre-Subcontract costs in accordance with Article 3.0 hereunder, which [REDACTED] shall pay in accordance with Article 4.0 hereunder.

1.1 OPTIONS TO EXTEND TERM

Leidos may exercise the options below to extend the period of performance by giving written notice to the Seller before the end of the then current period of performance:

- Phase 2: 18 months – Not Executed
- Option 1: Not Exercised

2.0 ESTIMATED COST AND FEE

The total estimated cost and fixed fee for the work to be performed under this Subcontract are:

Period of Performance	Estimated Cost (\$)	Fee (\$)	Cost Plus Fixed Fee (\$)
Phase 1 Period 21 May, 2021 – December 20, 2022	[REDACTED]	[REDACTED]	[REDACTED]
Phase 2 (Not Executed) 18 Months POP	[REDACTED]	[REDACTED]	[REDACTED]

FFP Phase / Period of Performance	Firm Fixed Price (\$)
Phase 1 [REDACTED] June 21, 2021 – December 20,2022	[REDACTED]
Phase 2 [REDACTED] (Not Executed)	[REDACTED]
Option 1 (Not Exercised)	[REDACTED]

[REDACTED]



2.1 FUNDING

This Subcontract is currently funded in the amount of [REDACTED]. Unless modified in writing by mutual agreement of the parties, Seller is not obligated to incur expenses or make commitments in excess of the Subcontract funded amount, and [REDACTED] is not obligated to compensate Seller beyond such amount. Seller shall provide the required notices set forth in FAR 52.232.22, Limitation of Funds. The foregoing notification requirement applies to each increment of funds provided to Seller under this Subcontract.

Funded Amount (\$)	
CPFF	[REDACTED]
FFP	[REDACTED]
TOTAL	[REDACTED]

2.2 COST ESTIMATES

Each month, by the 10th calendar day of the month, or the Friday after if the 10th falls on a weekend, the Seller is to provide spending plans with their actuals by month and cost estimates of out months [REDACTED] will provide the required template. Costs should be fully burdened by the Seller within the template. The file shall be submitted to:

- Program Manager [REDACTED]
- Financial Analyst [REDACTED]

3.0 INVOICES

Submit Invoices once a month by the 15th calendar day electronically to [REDACTED]. Submit invoices individually with only ONE invoice attached per email request (required backup should be provided with the invoice in a single PDF file). The subject line must be in the following format: Subcontract/PO No Invoice No Invoice Amount. Invoices shall contain the following information as the billed-to name and address: [REDACTED] and Seller's name and remit-to address, subcontract number, and, as applicable, labor categories, project labor categories, hourly rates, labor hours, and extended dollar totals by category. Materials and other direct costs detail shall be separated from labor costs, quantities, description of item/work, unit prices and extended prices, and/or total cost.

Invoices shall clearly reference a unique invoice number on each invoice, the period of incurred costs, and the date of the invoice. Invoices shall include the "Amount Previously Billed," the "Amount of this Invoice," and the "Total Amount Billed to Date" for each labor category. Seller shall submit invoices for the full amount stating the amount of withhold/retention if any for each line item billed.

Invoices for FFP efforts should be submitted separately from CPFF work for clarity and tracking purposes.

FFP invoices should be submitted for the value of [REDACTED] once a month by the 15th calendar day, until the funding level is reached.

3.2 BILLING RATES

Seller may include as allowable indirect costs such overhead rates as established by the cognizant Government agency in accordance with the principles of FAR Part 31 and any applicable agency supplements thereto. Pending establishment of final indirect overhead rates for any period, Seller shall be reimbursed at billing rates approved by the cognizant Government agency, which billing rates may be revised from time to time, subject to such agency approval and subject further to appropriate adjustment when the final rates for that period are established.

3.3 FINAL INDIRECT COST RATES

[REDACTED] shall reimburse Seller on the basis of final annual indirect cost rates and the appropriate bases established by Seller and the Government in effect for the period covered by the indirect cost rate proposal. Such rates and bases shall not change any monetary ceiling, funding amount, contract obligation, or specific cost allowance or disallowance provided for in this Subcontract. The rates and bases shall be automatically deemed incorporated into this Subcontract upon their effective dates.





3.4 FIXED FEE

██████████ shall pay the Seller for performing this Subcontract the fixed fee specified in Article 2.0; provided that after payment of 85 percent of said fixed fee, ██████████ may withhold further payment of fee to establish a reserve to be applied to adjustments in Seller's indirect cost rates. This reserve shall not exceed ██████████. ██████████ shall release 75 percent of the reserve after receipt of the certified final indirect cost rate proposal covering the year of physical completion of this Subcontract, provided Seller has satisfied all other Subcontract terms and conditions, including the submission of the final close-out documents, and is not delinquent in submitting final vouchers on prior years' settlements. ██████████ shall pay the remainder of the reserve upon completion of final Subcontract close-out.

4.0 PAYMENT

Upon receipt and approval by ██████████ of invoices that comply with Article 3.0, ██████████ shall pay allowable costs on a Net 30 day basis in accordance with FAR 52.216-7 (Allowable Cost and Payment) and any applicable agency supplements thereto. The total of lodging, meals and incidental expenses shall not exceed the established rate for each location set forth in the then-current Federal Travel Regulations (FTR) at 41 C.F.R. 300 et. seq.; Department of Defense Joint Travel Regulations (JTR), and Department of State Standardized Regulations (Government Civilians, Foreign Areas), as applicable. Seller shall adjust its allowable indirect costs under this Subcontract simultaneously with Seller's submittal of its final indirect cost rate proposal in accordance with FAR 52.216-7(d)(2)(i). In the event that Seller's final indirect cost rates, as determined by the Government in accordance with FAR 52.216-7(d)(2)(ii), vary from Seller's proposed rates, Seller shall adjust its allowable indirect costs within 30 days of such determination. In the event Seller fails to timely make such adjustments, or to certify to ██████████ that no adjustments are required to Seller's allowable indirect costs, ██████████ shall be under no obligation to consider subsequent requests by Seller to increase its allowable indirect costs under this Subcontract. Seller shall comply with FAR 52.232-20 (Limitation of Cost) and FAR 52.232-22 (Limitation of Funds), which are hereby incorporated by reference.

Seller will provide a letter of notification when they intend to reach 75% of the funds currently obligated to the reference contract 60 days before 75% of funds have been expended.

Each payment made shall be subject to reduction to the extent of amounts which are found by ██████████ or Seller not to have been properly payable, and shall also be subject to reduction for overpayments. Seller shall promptly notify ██████████ of any such overpayments found by Seller. ██████████ may offset against any payment due hereunder any amount owed to ██████████ by Seller.

Seller may select Automated Clearing House Credits ("ACH funds transfer") as the means of payment. With regard to such ACH funds transfer, a payment from ██████████ to Seller shall be considered timely with respect to any payment due date if the ACH funds transfer is completed no later than the due date. ██████████ shall not be in breach of these terms and conditions, or suffer any loss of discount or other penalty, with respect to an ACH funds transfer that was initiated properly and timely by ██████████ but its completion was delayed because of failure or delay by the ACH funds transfer system, the operation of an ACH funds transfer system rule which could not be anticipated by ██████████, or rejection by the Seller's bank.

4.1 AUDIT

At any time before final payment under this Subcontract, ██████████ may perform or have performed an audit of the invoices or vouchers and supporting documentation. Seller shall cooperate in any such audit, but may request that ██████████ or any auditing organization and Seller execute a non-disclosure agreement to provide for the confidentiality of the information that is exchanged.

4.2 CLOSEOUT

Seller agrees to submit its final invoice with Attachment V, Closeout Package (available from www.██████████.com/suppliers) within 30 days of completion of the work. Seller shall submit a FINAL invoice bearing the statement, "FINAL INVOICE" as required by the Subcontract Closeout Package. ██████████ may unilaterally close-out this subcontract if the Seller fails to submit the close-out documentation within the specified time period.

4.3 RETENTION OF RECORDS

Unless a longer period is specified in this Subcontract or by law or regulation, Seller shall provide ██████████ its customer, and the U.S. Government access to such records at no additional cost upon request.

5.0 REPRESENTATIONS AND CERTIFICATIONS

Seller attests to the accuracy of the Representations and Certifications incorporated into this order as attachment IV. The Seller shall provide immediate written notice to ██████████ if, at any time prior to subcontract closeout, the Seller learns that its (i) certifications were erroneous; (ii) has become erroneous by reason of changed circumstances; or (iii) has been

[REDACTED]

notified of any system deficiencies and/or related internal control structure or business system(s) that would affect its ability to report hours delivered accurately and completely, and bill costs according to FAR Part 31, Contract Cost Principles and Procedures. Failure to provide the required notice shall be a material breach of this Agreement and shall be grounds for immediate termination thereof by [REDACTED] in addition to any other remedies that may be available at law or in equity. Seller shall be responsible for submitting all periodic certifications to the cognizant [REDACTED] Contractual POC when required by the referenced FAR regulation or when required by the terms of this agreement.

6.0 SUBCONTRACT PROGRAM MANAGER (SPM), TECHNICAL AND CONTRACTUAL REPRESENTATIVES

[REDACTED]

Only the [REDACTED] Contractual Representative has the authority on behalf of [REDACTED] to make changes to this Subcontract, which can be done only in a writing signed by the [REDACTED] Contractual Representative. Either party may change its Technical or Contractual representative at any time, provided prompt notice is provided to the other party. All notices or other written communication required or permitted to be given under any provision of this Subcontract shall be in writing and shall be deemed to have been given by the notifying party if delivered by hand, facsimile (with confirmed receipt), electronic media (with confirmed receipt) or mailed by an overnight delivery service, to the receiving party's above-identified contractual representative. The SPM is the individual to provide technical and programmatic oversight and management of the subcontractor, to provide an independent assessment of the subcontractor's performance, and to identify, escalate and resolve subcontractor performance issues.

7.0 PERSONNEL

- (a) Personnel assigned to the labor categories set forth in Article 2.0 shall meet or exceed the minimum qualification and experience requirements specified in Attachment II, Labor Categories/Qualifications.
- (b) Seller has designated "Key Personnel" who are essential to the successful completion and execution of this Subcontract. Key Personnel shall perform all work necessary for the timely and quality completion of the task to which they are assigned. Seller may not substitute or replace a Key Personnel without [REDACTED] prior written approval. Seller's Key Personnel are Dr. Yamokoski (Grasping Academy Lead) and Nicolaus Radford (Single Platform Lead).
- (c) [REDACTED] reserves the right to direct the removal of any individual assigned to perform work under this Subcontract.

8.0 WARRANTY

Seller warrants that: 1) the services provided under this Subcontract shall be performed with that degree of skill and judgment normally exercised by recognized professional firms performing services of the same or substantially similar nature; and 2) that any goods delivered under this Subcontract will be new, unless otherwise specified, and for a period of twelve (12) months, be free from defects in design, material and workmanship and that all goods and services conform to applicable specifications, drawings, and standards of quality and performance. In the event of any breach of the foregoing warranties, Seller shall, at its own expense, at [REDACTED] election either: (1) re-perform the non-conforming services and/or correct or replace the non-conforming goods to conform to this standard; or (2) refund to [REDACTED] that portion of the amounts received by Seller attributable to the non-conforming services and/or goods. All warranties of Seller shall inure to the benefit of both [REDACTED] and [REDACTED] customers. The foregoing warranties shall survive any delivery, inspection, acceptance or payment by [REDACTED]. All other warranties, express or implied are hereby disclaimed by Seller.

8.1 INSPECTION

All goods supplied and services performed pursuant hereto shall be subject to inspection and test by buyer and its agents and by its customers at all times and places, whether during or after manufacture as to goods, or performance as to services, and notwithstanding the terms of delivery or payment or, as to goods, that title has not yet passed to Buyer or



to its customers. In the event that goods supplied are not performed in accordance with the specifications and instructions of Buyer, Buyer may require prompt correction thereof, or as to services, require that the services be rendered again at Seller's expense. If the Seller fails to proceed with reasonable promptness to perform required replacement or correction, and if the replacement or correction cannot be performed within the Not-To-Exceed ceiling price, the Buyer may terminate the subcontract for default.

9.0 INDEMNIFICATION

(a) Each Party (the "Indemnifying Party") shall indemnify, defend and hold the other Party and its officers, directors, employees, consultants, agents, affiliates, successors, permitted assigns and customers (the "Indemnified Party") harmless from and against any and all damages, losses, liabilities and expenses (including reasonable attorneys' fees) arising out of or relating to any claims, causes of action, lawsuits or other proceedings, regardless of legal theory, that result, in whole or in part, from the Indemnifying Party's (or any of the Indemnifying Party's subcontractors, suppliers, employees, agents or representatives): (i) intentional misconduct, negligence or fraud, (ii) breach of any provision of this Subcontract, including all representations, warranties and covenants made herein, or (iii) violation of any law or regulation. Notwithstanding the foregoing, the Indemnifying Party's obligations under this Article shall not apply to the extent that a claim is finally determined by a court of competent jurisdiction to be caused by the gross negligence or willful misconduct of the Indemnified Party.

(b) Upon written request by the Indemnified Party, the Indemnifying Party shall defend the Indemnified Party (if requested by the Indemnified Party in the name of the Indemnified Party) against any third-party claims, which if proven would result in an indemnification obligation under this clause, by attorneys and other professionals reasonably approved, in writing, by the Indemnified Party. In all events, case strategy will be determined by the Indemnifying Party if the Indemnifying Party so elects and no proceeding will be settled without the Indemnified Party's prior approval, which will not be unreasonably withheld.

(c) The Indemnified Party shall promptly notify the Indemnifying Party of any claim that is covered by this indemnification provision and shall authorize representatives of the Indemnifying Party to settle or defend any such claim or suit and to take charge of any litigation in connection therewith.

9.1 INFRINGEMENT INDEMNITY

Article VIII Infringement Indemnification) of the Collaboration Agreement effective December 4, 2020 between the Parties ("Collaboration Agreement") Shall govern any infringement claims under this Subcontract.

10.0 INSURANCE

(a) Without prejudice to Seller's liability to indemnify [REDACTED] as stated in any Indemnification provision contained in this Subcontract, Seller shall procure at its expense and maintain for the duration of this Subcontract, and ensure that any of its subcontractors used in connection with this Subcontract procure and maintain, the insurance policies required below.

(b) **Workers' Compensation:** Coverage for statutory obligations imposed by laws of any jurisdiction in which the work is to be performed. Where applicable, Seller shall provide evidence of United States Longshore & Harbor Workers' Compensation Act (USL&H) coverage for employees engaged in work on or near navigable waters of the United States, and Defense Base Act (DBA) coverage for all employees working on U.S. Government contracts outside the United States. Such policy(ies) shall be endorsed to provide a waiver of subrogation in favor of [REDACTED], its directors, officers and employees, and [REDACTED] customer where required by [REDACTED] Prime Contract with its customer. Employer's Liability coverage of \$1 million each accident shall also be maintained.

(c) **Commercial General Liability:** Coverage for third party bodily injury and property damage, including products and completed operations, contractual liability, and independent contractors' liability with limits not less than \$1,000,000 per occurrence and \$2,000,000 in the aggregate. Such policy(ies) shall be endorsed to provide a waiver of subrogation in favor of [REDACTED], its directors, officers and employees, and [REDACTED] customer when required by [REDACTED] contract with its customer and name [REDACTED], its directors, officers and employees, and [REDACTED] customer where required by [REDACTED] Prime Contract with its customer, as Additional Insureds.

(d) **Business Automobile Liability:** Coverage for use of all owned, non-owned, and hired vehicles with limits of not less than \$1,000,000 per accident combined single limit for bodily injury and property damage liability. Such policy(ies) shall be endorsed to name [REDACTED], its directors, officers and employees, and [REDACTED] customer where required by [REDACTED] Prime Contract with its customer, as Additional Insureds.





(e) **Professional Liability/Technology Errors and Omissions:** Coverage for liabilities, punitive damages, and claim expenses arising from errors, omissions, or negligent acts in rendering or failing to render professional services, computer or information technology services and in the provisioning of products in the performance of this Subcontract, including the failure of products to perform the intended function or serve the intended purposes, with limits not less than \$5,000,000. Services to be insured include but are not limited to: (1) systems analysis; (2) systems programming; (3) data processing; (4) systems integration; (5) outsourcing, including outsourcing development and design; (6) system design, consulting, development and modification; (7) training services relating to computer software or hardware; (8) management, repair and maintenance of computer products, networks and systems; (9) marketing, selling, servicing, distributing, installing and maintaining computer hardware or software; (10) data entry, modification, verification, maintenance, storage, retrieval or preparation of data output, and any other technology related services provided by the Seller.

(f) **Network Security/Privacy and Privacy Notification Costs (Cyber) Insurance:** If Seller is providing services that provide or include direct access to Buyer's or Buyer's Client's information technology systems or holding sensitive information of Buyer or Buyer's Client, then the above Technology Errors & Omissions insurance shall also include: Network Security/Privacy and Privacy Notification Costs (Cyber) Insurance: Coverage for loss, disclosure and theft of data in any form; media and content rights infringement and liability, including but not limited to, network security failure, including but not limited to, denial of service attacks and transmission of malicious code. Coverage shall include data breach regulatory fines and penalties, the cost of notifying individuals of a security or data breach, the cost of credit monitoring services and any other causally-related crisis management expense for up to one (1) year with limits not less than \$5,000,000. Coverage shall contain severability for the insured organization for any intentional act exclusions.

(g) Additionally, such policy(ies) required in (e) and (f) above shall cover consequential or vicarious liability (e.g. claims brought against Buyer or its Affiliated Companies and their respective directors, officers, and employees due to the wrongful acts and failures committed by Seller) and direct losses (e.g. claims made by [REDACTED] and its Affiliated Companies and their respective directors, officers, and employees against Seller for financial loss due to Seller's wrongful acts or failures). And, such policy(ies) shall also have the "Insured versus Insured" exclusion amended to allow an "Additional Insured" to bring a claim against the Named Insured. If the insurance required in (e) and/or (f) above are provided on a claims-made basis, then it must be maintained for a period of two (2) years after acceptance of the deliverables and/or services provided in connection with this Subcontract.

The Additional Insured coverages above shall be primary and non-contributing with respect to any other insurance that may be maintained by [REDACTED] and notwithstanding any provision contained herein, the Seller, and its employees, agents, representatives, consultants, subcontractors and suppliers, are not insured by [REDACTED] and are not covered under any policy of insurance that [REDACTED] has obtained or has in place.

Any self-insured retentions, deductibles and exclusions in coverage in the policies required under this Article shall be assumed by, for the account of, and at the sole risk of Seller. In no event shall the liability of Seller or any subcontractors be limited to the extent of any of insurance or the minimum limits required herein.

Prior to commencement of any work, and within 15 days of any policy renewal that occurs while any work is on-going under this Subcontract, Seller shall provide [REDACTED] evidence of the insurance coverage required above, including evidence of additional insured status and waivers of subrogation where required. Failure of Buyer to demand such evidence or to identify any deficiency in the insurance provided shall not be construed as or deemed to be a waiver of Seller's, or its subcontractors', obligations to maintain the above insurance coverages.

11.0 [REDACTED] FURNISHED ITEMS

All items furnished, loaned or bailed by [REDACTED] to Seller hereunder, or purchased, or otherwise acquired by Seller for the performance of and specifically charged to [REDACTED] under this Subcontract (collectively, the "Items"), are the property of [REDACTED] (or, as directed by [REDACTED] pursuant to the terms of its contract, the U.S. Government or a higher-tier contractor). Upon completion, expiration or termination of this Subcontract, Seller shall return to [REDACTED] all Items in good condition (reasonable wear only expected) together with all spoiled and surplus Items. In lieu of the return of Items to [REDACTED], Seller shall make such other disposition of Items as directed in writing by [REDACTED]. Seller agrees to replace, at its expense, all such Items not returned in accordance with this Section or returned in other than good condition. Seller shall not charge [REDACTED] for any storage, maintenance or return of any Items. Except as provided for in any clauses incorporated in Schedule B or elsewhere in this Subcontract, Seller shall bear all risk of loss for all Items in Seller's possession or for which Seller is responsible. Seller also agrees to use any designs, data or other things contained or embodied in Items provided to or utilized by Seller under this Subcontract in accordance with any restrictive legends placed on such Items by [REDACTED] or any third party. If [REDACTED] furnishes any material (including but not limited to any computer software or other data) for



[REDACTED]

fabrication pursuant to this Subcontract, Seller agrees: (i) not to substitute any other material for such fabrication without [REDACTED] prior written consent and (ii) that title to such material shall not be affected by incorporation in or attachment to any other property. The Government Property Requirements clause applies in lieu of this provision with respect to U.S. Government-furnished property or property to which the U.S. Government may take title.

11.1 GOVERNMENT PROPERTY REQUIREMENTS (AS APPLICABLE)

When U.S. Government Property is provided or acquired in connection with this Subcontract, the applicable Government Property clause in the Schedule B applies to that property. Seller shall i) certify to the completion of a physical inventory (all government equipment and materials) for year ending June 30 and the results thereof NLT July 31, annually or as otherwise required by the agency applicable property clause incorporated in the Schedule B Part II; ii) submit disposition requests when Government property is no longer required on the subcontract; iii) report any loss, damage, destruction or theft of Government property immediately after discovery; and iv) comply with close out of all Government property requirements to include, but not limited to submission of a final Government property report, final inventory report, and certification of the inventory condition code. Property closeout certification shall be submitted no later than 60 days after end of period of performance. All notices and required written communication shall be sent to subproperty@[REDACTED].om. Unless otherwise provided for in this subcontract or approved by the Contracting Officer, Government property, either furnished or acquired under this contract, shall be utilized only in support of Buyer's prime contract. Property which is no longer being utilized should be reported when it becomes excess to the Seller's requirements.

PRESERVATION OF THE GOVERNMENT'S RIGHTS - If [REDACTED] furnishes data, designs, drawings, jigs, special tooling, equipment, engineering data, or other technical or proprietary information ("Furnished Items") which the U. S. Government has the right to authorize the use of, nothing herein shall be construed to mean that [REDACTED] acting on its own behalf, may modify or limit any rights the Government may have to authorize Seller's use of such Furnished Items in support of other U. S. Government prime contracts.

If Seller does not have a Government approved property system, Seller shall also comply with the following: i) Document receipt of Government property accountable to this subcontract (A copy of the signed packing slip or other documentation received with the property, including issue signature, must be forwarded within 30 days of receipt, report any item fabricated for use on the subcontract which is to be retained by the Seller, and annotate the receipt documentation with any Government property ID numbers with which the property is tagged; ii) Submit an annual (year ending June 30) physical inventory of Government equipment and material by July 31 that includes the Control number, Noun description, Model number (if applicable), Part number (if applicable), Serial number, unit price, date of last use for taggable property and inventories for material items should also include the quantity of line items and a total price; iii) Immediately report changes to the information provided to [REDACTED] upon receipt of Government property; iv) Store and maintain property to protect it against deteriorating agents, adverse environments, damage and theft; v) Allow site access upon request to facilitate property surveillance activities required by [REDACTED] prime contract; vi) Obtain advanced approval from [REDACTED] for the acquisition of any non-deliverable, which would not be consumable or expendable property and movement of Government property from authorized plants.

12.0 INTELLECTUAL PROPERTY

(a) Seller understands and agrees that each of the Intellectual Property-related clauses specified in Schedule B, which may include (but are not limited to) FAR 52.227-1, 52.227-11, 52.227-14, 52.227-15 and 52.227-16 (and/or DFARS 252.227-7013, 252.227-7014 and 252.227-7015 if [REDACTED] prime contract is with the DOD), are incorporated herein as though fully set forth and shall take precedence over any other terms in this Subcontract. For avoidance of doubt, Seller hereby grants to [REDACTED] such intellectual property rights as [REDACTED] needs in order to perform its obligations to [REDACTED] U.S. Government customers or a higher-tier contractor supporting programs related to the Collaboration Agreement (i.e., the [REDACTED]) that are identified in advance as applicable to Subcontractor, provided that such rights are limited to those rights necessary to perform its obligations to [REDACTED] U.S. Government customers or a higher-tier contractor, and not independent intellectual property rights for use outside of the Subcontract. Seller shall not assert any intellectual property right provided to the U.S. Government in a manner inconsistent with [REDACTED] contract obligations (identified to Subcontractor in advance) to [REDACTED] U.S. Government and higher-tier customers, or inconsistent with the rights obtained by the U.S. Government.

(b) To the extent that Seller provides any commercial computer software under this Subcontract, the Parties agree that any commercial terms governing such commercial computer software shall govern use of such commercial software, except to the extent that such commercial terms conflict or are inconsistent with applicable federal law or regulation. In

[REDACTED]

the case of any conflict or inconsistency, the applicable federal law or regulation shall take precedence over any conflicting or inconsistent commercial term. The Parties further agree that the use of any commercial terms shall be contingent upon the acceptance of any commercial computer software by the U.S. Government. In addition, the Parties agree that to the extent that the U.S. Government is the end user of any commercial computer software provided by Seller [REDACTED] shall have the right to perform [REDACTED] contract obligations, under the Prime Contract for which Seller is a subcontractor to its U.S. Government Customers using that commercial computer software.

(c) In addition to the Government's rights in data and inventions Seller grants [REDACTED] in the performance of its prime or higher tier contract obligations for the [REDACTED] (including obligations of follow-on contracts or contracts for subsequent phases of the same program), an unlimited, irrevocable, paid-up, royalty-free right to make, have made, sell, offer for sale, use, execute, reproduce, display, perform, distribute (internally or externally) copies of, and prepare derivative works, and authorize others to do any, some or all of the foregoing, any and all, inventions, discoveries, improvements, maskworks and patents as well as any and all data, copyrights, reports, and works of authorship, conceived, developed, generated or delivered in performance of this Subcontract.

(d) Seller grants [REDACTED] all rights necessary to use the Deposit Material that is the subject of the Three-Party Escrow Service Agreement effective June 22, 2021, between the Parties and the NCC Group to perform its prime or higher tier contract obligations (including obligations of follow-on contracts or contracts for subsequent phases of the same program) in the case that the Deposit Material is released by the NCC Group to [REDACTED]

12.1 FREE, LIBRE AND OPEN SOURCE SOFTWARE (FLOSS)

(a) This clause only applies to work that includes the delivery of software (including software residing on hardware).

(b) Seller shall disclose to [REDACTED] in writing any FLOSS that will be used or delivered in connection with this Subcontract and shall obtain [REDACTED] prior written consent before using or delivering such FLOSS in connection with this Subcontract.

(c) As used herein, "FLOSS License" means the General Public License (GPL), Lesser/Library GPL, (LGPL), the Affero GPL (APL), the Apache license, the Berkeley Software Distribution (BSD) license, the MIT license, the Artistic License (e.g., PERL), the Mozilla Public License (MPL), or variations thereof, including without limitation licenses referred to as "Free Software License", "Open Source License", "Public License", or "GPL Compatible License." As used herein, "FLOSS" means software that incorporates or embeds software in, or uses software in connection with, as part of, bundled with, or alongside any (1) open source, publicly available, or "free" software, library or documentation, or (2) software that is licensed under a FLOSS License, or (3) software provided under a license that (a) subjects the delivered software to any FLOSS License, or (b) requires the delivered software to be licensed for the purpose of making derivative works or be redistributable at no charge, or (c) obligates [REDACTED] to sell, loan, distribute, disclose or otherwise make available or accessible to any third party (i) the delivered software, or any portion thereof, in object code and/or source code formats, or (ii) any products incorporating the delivered software, or any portion thereof, in object code and/or source code formats.

(d) Seller shall defend, indemnify, and hold harmless [REDACTED] its customers and suppliers from and against any third party claims, damages, losses, costs, and expenses, including reasonable attorney's fees, relating to use in connection with this Subcontract or the delivery of FLOSS. No other provision in this Subcontract, including but not limited to any indemnity clause, shall be construed to limit the liabilities or remedies of the parties for the use of FLOSS in connection with this Subcontract or for delivery of FLOSS under this Subcontract.

13.0 NEW MATERIAL

All goods to be delivered hereunder shall consist of new materials, as defined in FAR 52.211-5, not used, or reconditioned, remanufactured, or of such age as to impair its usefulness or safety.

13.1 COUNTERFEIT PRODUCTS

(a) For purposes of this clause, Goods are any tangible items delivered under this Subcontract (including computer software or firmware embedded in electronic parts), including without limitation the lowest level of separately identifiable items, such as parts, articles, components, and assemblies. "Counterfeit Goods" are Goods that are or contain items misrepresented as having been produced, by an Original Component Manufacturer (OCM) or an Original Equipment Manufacturer (OEM) or having been obtained through an OCM/OEM authorized distributor chain, including without limitation unauthorized copies, replicas, or substitutes. The term "Counterfeit Goods" also includes Goods that have reached a design life limit, have false identifications of grade, serial or lot number, or have been damaged, but are misrepresented as acceptable.

[REDACTED]

(b) Seller agrees and shall ensure that Counterfeit Goods are not delivered to Buyer. Goods shall not be acquired from independent distributors or brokers unless approved in advance in writing by [REDACTED]. When requested by [REDACTED], Seller shall provide OCM/OEM documentation that establishes the traceability of the affected items to the applicable OCM/OEM.

(c) In the event that Goods delivered under this Subcontract constitutes or include Counterfeit Goods, Seller shall, at its expense, promptly replace such Counterfeit Goods with authentic Goods conforming to the requirements of this Subcontract. Notwithstanding any other provision in this Subcontract, Seller shall be liable for all costs relating to the removal and replacement of Counterfeit Goods, including without limitation [REDACTED] costs of removing Counterfeit Goods, of reinserting replacement Goods, and of any testing necessitated by the reinstallation of Goods after Counterfeit Goods have been exchanged. Seller shall include equivalent provisions in lower tier subcontracts for the delivery of items that will be included in or furnished as Goods to Buyer.

(d) If Seller becomes aware that it has delivered Counterfeit Goods, it shall immediately notify [REDACTED] and provide pertinent facts. Seller, at its expense, shall provide reasonable assistance to [REDACTED] in any investigation relating to the delivery of Counterfeit Goods or Goods that are suspected to be Counterfeit Goods.

13.2 CONFLICT MINERALS

[REDACTED] fully supports the goals and objectives of Section 1502 of the Dodd-Frank Wall Street Reform and Consumer Protection Act (the "Act") which aims to prevent the use of certain "Conflict Minerals" that directly or indirectly finance or benefit armed groups in the Democratic Republic of the Congo (DRC) or its adjoining countries (as defined in the Act). It is the expectation of [REDACTED] that all our suppliers have a policy to reasonably assure that the tantalum, tin, tungsten and gold ("3TG") in the products they manufacture are conflict free. In connection with that policy, [REDACTED] expects our suppliers to undertake appropriate due diligence measures to determine if the 3TG materials in their products are being sourced from certified conflict-free smelters validated as compliant with the Conflict-Free Smelter Program (CFS) protocol and found on the CFS Compliant Smelter List. By accepting this order, Seller agrees to participate in future due diligence surveys from [REDACTED] routinely evaluates our relationship with our suppliers and will consider the extent to which a supplier has failed to comply with these responsibilities under the Act. If it is determined that a supplier's efforts are deficient, we may take appropriate action, including terminating our relationship with the supplier.

14.0 ASSIGNMENTS AND SUBCONTRACTS

(a) This Subcontract may not be assigned, novated or otherwise transferred by operation of law or otherwise by Seller without prior written consent from [REDACTED] which consent shall not be unreasonably withheld. Any change of control of Seller shall be deemed an assignment of this Subcontract that requires the prior written consent of [REDACTED]. For purposes of this Agreement, "change of control" means any merger, consolidation, sale of all or substantially all of Seller's assets or sale of a substantial block of Seller's stock. Any such assignment, novation or transfer or attempted assignment, novation, or transfer not in accordance with this provision shall be a material breach of this Subcontract and shall be grounds for immediate termination thereof by [REDACTED] in addition to any other remedies that may be available at law or in equity.

(b) Seller shall obtain prior written consent before subcontracting any portion of the work covered in this Subcontract that was not disclosed in Seller's proposal. Seller shall include in each lower-tier subcontract the appropriate flow down clauses as required by the FAR and any applicable agency supplements (e.g., DFARS, GSARS, etc.) identified in the Schedule B, Schedule C, or other referenced document applicable to this Subcontract. Further, Seller shall notify [REDACTED] Contractual Representative in writing if the Seller changes the amount of any lower-tier subcontract effort such that, the sum of lower-tier subcontractor(s) performance may reach or exceeds 70 percent of the total cost of work to be performed by Seller under the Agreement. The notification shall identify the revised percentage of Seller's effort and shall include verification that the Seller will provide added value as related to the work to be performed by the lower-tier subcontractor(s) and a description of that value. Seller shall indemnify [REDACTED] for any reduction to [REDACTED] contract price arising out of the Government's determination that excessive pass-through charges exist in Seller's price.

15.0 INDEPENDENT CONTRACTOR

Seller is an independent contractor in all respects with regard to this Subcontract. Nothing contained in this Subcontract shall be deemed or construed to create a partnership, joint venture, agency, or other relationship with [REDACTED] other than that of contractor and customer. Seller shall be responsible for compliance with all laws applicable to its employees, including, but not limited to, payment of wages, overtime, social security contributions, worker's compensation, and all other employment, labor, or benefits related laws. Seller personnel performing work under this Subcontract shall not for

[REDACTED]

any purpose be considered employees or agents of [REDACTED] nor do Seller or Seller's personnel have any rights under any benefit plans of [REDACTED]

16.0 DISCLOSURE

(a) Seller shall not disclose information concerning work under this Subcontract to any third party, unless such disclosure is required by law, is necessary for the performance of this Subcontract, or inconsistent with the rights obtained by the U.S. Government. No news releases, public announcement, denial or confirmation of any part of the subject matter of this Subcontract or any phase of any program hereunder shall be made without prior written consent of [REDACTED] which shall not be unreasonably withheld. Seller shall not use [REDACTED] or any other trademark or logo owned by [REDACTED] or its affiliates without the prior written consent of [REDACTED]

(b) [REDACTED] shall be solely responsible for all liaison and coordination with [REDACTED] customer as it affects the applicable prime contract and this Subcontract, and Seller shall not communicate with [REDACTED] customer, a higher-tier customer this Subcontract supports, or the representatives of the program [REDACTED] contract supports without the prior written approval of [REDACTED]. This does not prevent the Seller from communicating with the U.S. government (a) with respect to matters Subcontractor is required by law, regulation, or this Subcontract to communicate directly with the U.S. government or (b) to lawfully report waste, fraud, or abuse related to the performance of a Government contract to a designated investigative or law enforcement representative of a Federal department or agency authorized to receive such information

(c) Seller shall provide adequate security to safeguard [REDACTED] and [REDACTED] customer information, including such information on its information systems, from unauthorized access and disclosure. If Seller becomes aware of any improper disclosure (including through unauthorized access) of such information or other information used in the performance of this Subcontract, Seller shall take appropriate and immediate actions to investigate and contain the disclosure and shall promptly report the disclosure to [REDACTED]. Seller shall provide reasonable cooperation to [REDACTED] in conducting any investigation regarding the nature and scope of the disclosure.

17.0 WORK ON BUYER AND THIRD PARTY PREMISES

(a) "Premises" as used in this clause means premises of [REDACTED], its customers, or other third parties where Work is being performed.

(b) Seller shall ensure that Seller personnel working on Premises comply with any on-premises policies and comply with any required rules relating to the premises including, but not limited to the following: (i) do not bring weapons of any kind onto Premises; (ii) do not manufacture, sell, distribute, possess, use or be under the influence of controlled substances or alcoholic beverages while on Premises; (iii) do not possess hazardous materials of any kind on Premises without [REDACTED] authorization; (iv) remain in authorized areas only; (v) do not conduct any [REDACTED] related business activities (such as interviews, hirings, dismissals or personal solicitations) on Premises, (vi) do not send or receive [REDACTED] related mail through [REDACTED] or third party's mail systems; (vii) do not sell, advertise or market any products or memberships, distribute printed, written or graphic materials on Premises without [REDACTED] written permission or as permitted by law; and (viii) follow instruction from [REDACTED] in the event of an actual or imminent safety or environmental hazard on Premises.

(c) Seller personnel and all other persons, property, and vehicles entering or leaving Premises are subject to search.

(d) Seller shall promptly notify [REDACTED] and provide a report of any accidents or security incidents involving Seller personnel on Premises including but not limited to loss of or misuse or damage to [REDACTED] customer's, or third party intellectual or physical assets, and all physical altercations, assaults, or harassment.

(e)(i) Prior to entry on Premises, Seller shall coordinate with [REDACTED] to gain access for Seller personnel. For such purpose Seller shall provide information reasonably required by [REDACTED] to ensure proper identification of personnel, including, but not limited to verification of citizenship, lawful permanent resident status, protected individual or other personal status.

(e)(ii) Seller personnel requiring unescorted access to Premises shall, prior to entry, be subject to a request for additional information as may be reasonably requested to enable unescorted access at the Premises.

(f) Seller shall ensure that Seller personnel: (i) do not remove [REDACTED], customer, or third party assets from Premises without [REDACTED] authorization; (ii) use [REDACTED] customer, or third party assets only for purposes of this subcontract; (iii) only connect with, interact with or use computer resources, networks, programs, tools or routines authorized by [REDACTED] and (iv) do not share or disclose user identifiers, passwords, cipher keys or computer dial port telephone numbers. [REDACTED] may periodically audit Seller's data residing on [REDACTED] customer, or third party assets on Premises.

(g) [REDACTED] may, at its sole discretion, have Seller remove any specified employee of Seller from Premises and require that such employee not be reassigned to any Premises under this subcontract.

[REDACTED]

(h) Violation of this clause may result in termination of this subcontract in addition to any other remedy available to [REDACTED] at law or in equity. Seller shall reimburse [REDACTED] customer, or third party for any unauthorized use of [REDACTED] customer, or third party assets.

(i) Seller shall advise the [REDACTED] Contractual Representative of any unauthorized direction or course of conduct.

(j) Seller shall immediately report to [REDACTED] all emergencies (e.g., medical, fire, spills or release of any hazardous material) and non-emergency incidents (e.g., job-related injuries or illnesses) affecting the Work. Seller shall provide [REDACTED] with a copy of any reports of such incidents Seller makes to governmental authorities.

18.0 STANDARDS OF BUSINESS CONDUCT, ETHICS, SUSTAINABILITY, AND SOCIAL RESPONSIBILITY

(a) [REDACTED] is committed to conducting its business fairly, impartially and in an ethical and proper manner. These characteristics make it imperative that [REDACTED] employees adhere to a particularly high ethical standard in accordance with [REDACTED] Code of Conduct, which may be viewed at [www.\[REDACTED\].com](http://www.[REDACTED].com). [REDACTED] values relationships that are grounded in a shared commitment to performing in accordance with the highest standards of professional business conduct and encourages all suppliers to implement an effective ethics program, including adopting a written code of conduct with a process for reporting concerns and preventing retaliatory actions. In performance of this subcontract, [REDACTED] expects the Seller to conduct themselves in a manner consistent with the principles expressed in either the [REDACTED] Code of Conduct or the Defense Industry Initiative (DII) Model Supplier Code of Conduct, which can be viewed at <https://www.dii.org/featured-tools>. As evidence of our commitment, should Seller wish to review [REDACTED] training for your organization, request a copy through Buyer's contractual point of contact. If Seller has cause to believe that [REDACTED] any employee or agent of [REDACTED] or any Subcontractor employee has acted improperly or unethically under this Subcontract, Seller shall report such behavior to the [REDACTED] Ethics Hotline at [REDACTED]. [REDACTED] provides its Code of Conduct and ethics training for informational purposes only, and makes no representations as to its appropriateness for use outside of [REDACTED].

(b) Seller shall not offer or give something of value to [REDACTED] or any employees of [REDACTED] for the purpose of obtaining or rewarding favorable treatment in connection with this Subcontract. Seller agrees that in connection with the services being provided by its contract and this subcontract, it shall neither undertake, nor cause, nor permit to be undertaken, any activity which either: (i) is illegal under any applicable Laws, or (ii) would have the effect of causing [REDACTED] to be in violation of any United States, or other applicable Laws, including, but not limited to, the U.S. Foreign Corrupt Practices Act. Seller represents that it is familiar with and understands the provisions of the U.S. Foreign Corrupt Practices Act (FCPA) and the U.K. Bribery Act and that neither it nor any of its officers or directors is/are a government Official. Seller represents that none of its employees, officers, directors or agents who will work on the contract, or with [REDACTED] on this subcontract has been indicted or otherwise linked to corrupt conduct or any other wrongdoing, based on all evidence from internal investigations and current law enforcement investigations. By accepting this Subcontract, Buyer certifies that neither it nor any of its employees has made or solicited a kickback in violation of the Anti-Kickback Act of 1986, 41 U.S.C. Chap. 87.

(c) [REDACTED] is committed to minimizing our impact on the environment, promoting safe workplace conditions, and the protection of internationally proclaimed human rights. In the performance of this subcontract, [REDACTED] expects the Seller to comply with all local environmental, health, and safety regulations. [REDACTED] encourages Seller to use processes, materials, and transportation methods that support sustainability of the environment throughout the supply chain (e.g., applying energy-efficient, environmentally friendly technologies to reduce waste, and emissions to air, water, and soil). Further, Seller shall not engage in the discrimination of employees or discriminate in the selection of lower-tier suppliers on the basis of sex, race, color, age, religion, creed, sexual orientation, national origin or citizenship, ancestry, disability, marital status, gender identity, military or veteran status, or any other basis protected by law.

19.0 ORGANIZATIONAL CONFLICT OF INTEREST

Seller represents and warrants that its performance of this Subcontract does not constitute and will not create an organizational conflict of interest (OCI) as defined in FAR Part 9.5 or under any other applicable OCI clause or regulation. If during the course of performance, Seller becomes aware of any actual or potential organizational conflict of interest caused by its performance of this Subcontract, Seller shall promptly notify [REDACTED] in writing of the nature of such actual or potential organizational conflict of interest. An OCI that, in the view of [REDACTED] customer, cannot be mitigated, is a basis for termination of this Subcontract at no further cost to [REDACTED].



20.0 GOVERNING LAW

This Subcontract shall be governed by and construed in accordance with the laws of the Commonwealth of Virginia without regard to its conflicts of laws rules, except that any provision that is incorporated, either in full text or by reference, from the Federal Acquisition Regulation (FAR), agency supplements to the FAR, or that is substantially based on any such provision shall be interpreted according to the federal common law of government contracts.

20.1 COMPLIANCE WITH LAW

(a) Seller agrees to comply with the applicable provisions of any federal, state or local law or ordinance and all orders, rules and regulations issued thereunder. Seller shall obtain all licenses and permits required to perform work required by this Subcontract at its expense and shall pay all fees and other required charges. Seller, at its expense, shall provide reasonable assistance and cooperation to [REDACTED] in conducting any investigation arising out of any failure by Seller or its personnel to comply with applicable law or regulation in connection with the performance of this Subcontract and shall notify [REDACTED] promptly in writing if a charge of noncompliance with any such law or regulation is made.

(b) To the extent that performance of this Subcontract requires that Seller's employees be deployed outside the United States ("Deployed Personnel"), Seller shall at all times be responsible for its Deployed Personnel's compliance with applicable local, state, and host nation laws, and Seller shall bear all risks, costs, damages or liabilities that may result from any non-compliance. Should Seller wish that its Deployed Personnel be authorized to carry a weapon, Seller: (1) shall forward a request to the Contracting Officer (or other authorized Government official) for approval; (2) shall comply with the requirements of all Government instructions, regulations, directives, orders, and policies pertaining to the possession and use of weapons by contractor personnel; (3) shall bear all risks, costs, damages or liabilities that may result from the possession or use of weapons by its Deployed Personnel, and (4) shall indemnify [REDACTED] for any and all claims or liabilities that arising from or relating to such weapons use or possession. Seller acknowledges and agrees that [REDACTED] neither authorizes nor requires Seller's Deployed Personnel to possess weapons.

20.2 EXPORT CONTROL COMPLIANCE

(a) Seller shall comply with all applicable U.S. and local export control laws and regulations, including the International Traffic in Arms Regulations ("ITAR"), the Export Administration Regulations ("EAR") and the Foreign Asset Control Regulations ("FACR"). The subject technology of this Subcontract (including data, services, software and hardware) provided hereunder, may be controlled under these laws and regulations (Controlled Technology). Controlled Technology may not be exported, re-exported, or retransferred without prior authorization in accordance with the ITAR and EAR. Access to Controlled Technology by Foreign Persons as defined by 22 C. F. R. 120.16 may require an export authorization. Seller has full responsibility for obtaining any export licenses or authorization required to fulfill its obligations under this Subcontract and export laws and regulations.

(b) Seller shall notify [REDACTED] in writing if any deliverable under this Subcontract is Controlled Technology, provide the export classification of that Controlled Technology, and notify [REDACTED] of any changes in that classification. Seller shall provide [REDACTED] all information and documentation reasonably required for [REDACTED] to prepare and submit any export license applications should [REDACTED] need to obtain such a license in connection with a deliverable under this Subcontract.

(c) Notwithstanding any other provision of this Subcontract, no party shall take or be required to take any action that is prohibited or penalized under the laws of the United States or any applicable foreign jurisdiction, including without limitation the antiboycott laws administered by the U.S. Commerce and Treasury Departments.

20.3 ENDING TRAFFICKING IN PERSONS

(a) This contract incorporates by reference FAR clause 52.222-50 – Combating Trafficking in Persons. In addition to complying with the requirements of that clause, Seller shall immediately report to the [REDACTED] Hotline at [REDACTED] credible information it receives of or an actual violation of the prohibitions in paragraph (b) of that clause. Reports may, in addition, be made to the Global Human Trafficking Hotline at 1-844-888-FREE and help@befree.org.

(b) Upon request, Seller shall provide information to [REDACTED] demonstrating its compliance with the requirements of the clause, including, where applicable, a compliance plan and any corrective actions implemented as a result of any violations of the clause.





20.4 DPAS PRIORITY RATING

If so identified, this Subcontract is a "rated order" certified for national defense use, and Seller's signature constitutes acceptance of and agreement to follow all requirements under the Defense Priorities and Allocation System Regulation (15 C.F.R. Part 700).

21.0 CHANGES

Seller shall assert its right to an adjustment under the applicable Changes clause within 20 days from the date of receipt of the written order. Failure to agree to any adjustment will be a dispute under the Disputes clause of this Subcontract. Provided, however, that nothing in this clause excuses the Seller from proceeding with the work as changed without interruption and without awaiting settlement of any such dispute.

22.0 PROHIBITION OF DISCRIMINATION

To the extent not exempt, this contractor and subcontractor shall abide by the requirements of 41 CFR §§ 60-1.4(a), 60-300.5(a) and 60-741.5(a). These regulations prohibit discrimination against qualified individuals based on their status as protected veterans or individuals with disabilities, and prohibit discrimination against all individuals based on their race, color, religion, sex, sexual orientation, gender identity, or national origin. Moreover, these regulations require that covered prime contractors and subcontractors take affirmative action to employ and advance in employment individuals without regard to race, color, religion, sex, sexual orientation, gender identity, national origin, protected veteran status, or disability. In addition, this contractor will not discharge or in any other manner discriminate against any employee or applicant for employment because such employee or applicant has inquired about, discussed, or disclosed the compensation of the employee or applicant or another employee or applicant. To the extent not exempt, this contractor and subcontractor shall also abide by the requirements of 29 CFR Part 471, Appendix A.

23.0 DISPUTES

(a) [REDACTED] and Seller agree to enter into negotiations to attempt to resolve any dispute arising out of or relating to this Subcontract. Both parties agree to negotiate in good faith to attempt to reach a mutually agreeable settlement within a reasonable amount of time.

(b) If negotiations are unsuccessful, the parties agree that the sole and exclusive venue for any legal proceeding arising out of or relating to this Subcontract shall be in the state or federal courts of the Commonwealth of Virginia. The parties expressly submit to the jurisdiction of the state and federal courts of the Commonwealth of Virginia and agree that any party that unsuccessfully challenges the enforceability of this forum selection clause shall reimburse the other party all reasonable attorneys' fees and costs incurred in defending such unsuccessful challenge. Each party waives any right it might have to a trial by jury in respect to any litigation directly or indirectly arising under or relating to this Subcontract.

(a) Seller shall proceed diligently with performance of this contract, pending final resolution of any dispute arising under the Subcontract, and comply with any decision of the [REDACTED] Contractual Representative.

24.0 NON-WAIVER OF RIGHTS

The failure of either party to insist upon strict performance of any of the terms and conditions in the Subcontract, or to exercise any rights or remedies, shall not be construed as a waiver of its rights to assert any of the same or to rely on any such terms or conditions at any time thereafter. The invalidity in whole or in part of any term or condition of this Subcontract shall not affect the validity of other parts hereof.



25.0 ORDER OF PRECEDENCE

The documents listed below are hereby incorporated by reference. In the event of an inconsistency or conflict between or among the provisions of this Subcontract, the inconsistency shall be resolved by giving precedence in the following order, except to the extent that any inconsistency involving a mandatory FAR or DFARS Clause that is included in the Prime Contract shall be resolved such that the mandatory FAR or DFARS clause will always take precedence:

1. Schedule A: Specific Terms and Conditions (Rev. 2020-11)
2. Articles **dated 26 July 2021 v2**
3. Attachment I: Statement of Work (Rev. 04/27/2021)
4. Attachment IV: Seller's Representations and Certifications, dated July 28, 2021
5. Attachment V: Closeout Package (provided for at www.██████████.com/suppliers)

26.0 SURVIVAL

If this Subcontract expires, is completed, or is terminated, Seller shall not be relieved of those obligations contained in the following articles: 1.0, 3.0, 3.1, 3.2, 3.3, 3.4, 4.0, 4.1, 4.2, 4.3, 5.0, 6.0, 8.0, 9.0, 9.1, 10.0, 11.0, 11.1, 12.0, 12.1, 13.1, 15.0, 16.0, 17.0, 18.0, 20.0, 20.1, 20.2, 21.0, 22.0, 23.0, 25.0, 26.0, and 27.0.

27.0 ENTIRE AGREEMENT

The parties hereby agree that this Subcontract shall constitute the entire agreement and understanding between the parties hereto and shall supersede and replace any and all prior or contemporaneous representations, agreements or understandings of any kind, whether written or oral, relating to the subject matter hereof. Unless expressly accepted in writing by ██████████ additional or differing terms or conditions included in any acknowledgment by Seller, including but not limited to, any Purchase Order issued by Seller, are objected to by ██████████ and are agreed to have no effect.

By Seller's signature of this Subcontract, Seller certifies to the best of its knowledge and belief that no Federal appropriated funds have been paid or will be paid to any person for influencing or attempting to influence an officer or employee of any agency, a Member of Congress, an officer or employee of Congress, or an employee of a Member of Congress on its behalf in connection with the awarding of this subcontract.

Seller further certifies the organization or any of its Principals are not presently debarred, suspended, proposed for debarment or declared ineligible for the award of contracts by any Federal agency. In the event the Seller is proposed for debarment, suspended, or debarred by any Federal agency during the performance term of this Subcontract, Seller shall notify the ██████████ contractual representative immediately in writing.

In witness whereof, the duly authorized representatives of ██████████ and the Seller have executed this Subcontract on the dates shown below.

SELLER:

Houston Mechatronics, Inc.

(Company Name)

x *Reginald P. Berka*

(Signature)

NAME: REG BERKA

(Type or Print)

TITLE: EXEC VP OF OPERATIONS

DATE: August 13, 2021

██████████ **INC.:**

██████████

(Signature)

██████████

(Type or Print)

TITLE: LEAD, SUBCONTRACT ADMINISTRATOR

DATE: 08/13/2021

[Redacted]

Date: April 27, 2021

[Redacted]

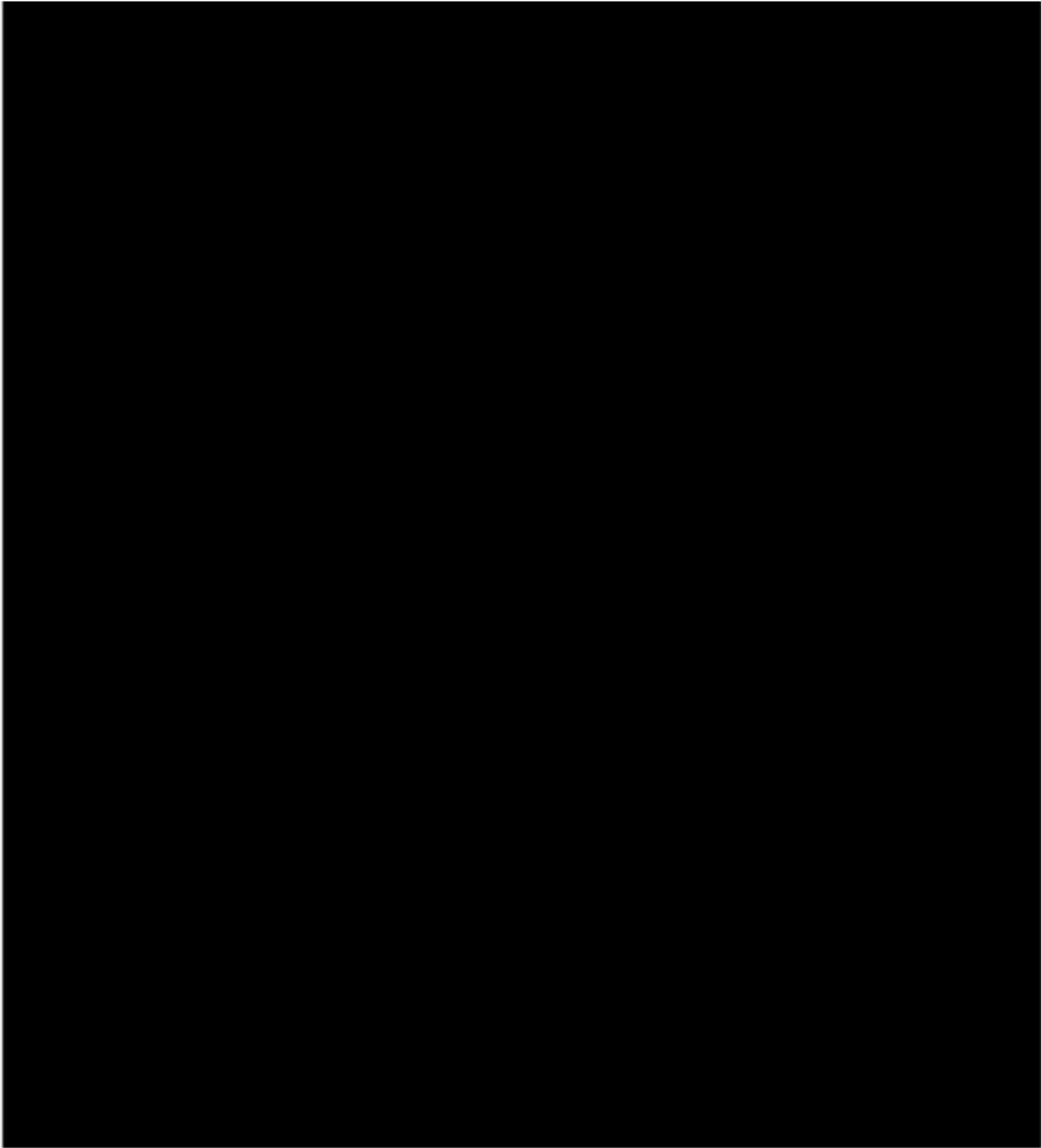
[Redacted]

[Redacted]

[Redacted]

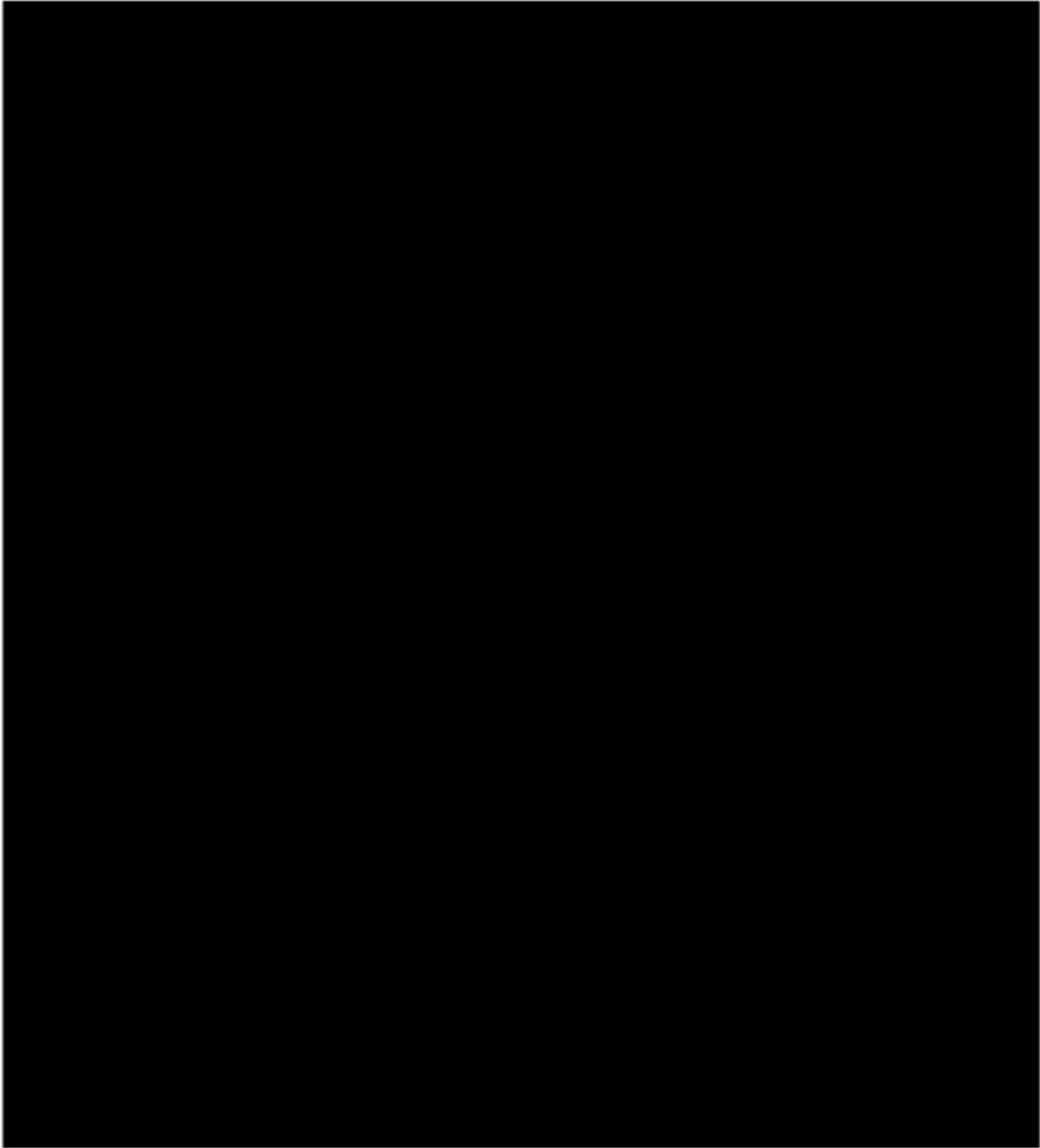
[REDACTED]

[REDACTED]



[Redacted]

[Redacted]



[REDACTED]

[REDACTED]

1. DEFINITIONS

In the U.S. Government clauses contained in the Schedule C document, unless the context of the clause requires otherwise, the term "Contractor" shall mean Seller, the term "Contract" shall mean the Subcontract or Purchase Order, and the terms "Government," "Contracting Officer" and equivalent phrases shall mean [REDACTED] and [REDACTED] Contractual Representative, respectively. It is intended that these clauses shall apply to Seller in such manner as is necessary to reflect the position of Seller as a subcontractor to [REDACTED] to insure Seller's obligations to [REDACTED] and to the United States Government, and to enable [REDACTED] to meet its obligations under its Prime Contract and the Subcontract. All references to Subcontract shall include purchase orders and unless otherwise stated, all definitions defined by [FAR 2.101](#) shall be applied to the terms referenced herein.

2. CONTRACT SPECIFIC FLOW DOWNS

- ARTICLE I: RESERVED**
- ARTICLE II: RESERVED**
- ARTICLE III: RESERVED**
- ARTICLE IV: RESERVED**
- ARTICLE V: RESERVED**
- ARTICLE XIX: RESERVED**

ARTICLE VI: DISPUTES

A. General

The Parties shall communicate with one another in good faith and in a timely and cooperative manner when raising issues under this Article.

B. Dispute Resolution Procedures

1. Any disagreement, claim or dispute between [REDACTED] and the Performer concerning questions of fact or law arising from or in connection with this Agreement, and, whether or not involving an alleged breach of this Agreement, may be raised only under this Article.

2. Whenever disputes, disagreements, or misunderstandings arise, the Parties shall attempt to resolve the issue(s) involved by discussion and mutual agreement as soon as practicable. In no event shall a dispute, disagreement or misunderstanding which arose more than three (3) months prior to the notification made under subparagraph B.3 of this article constitute the basis for relief under this article unless the [REDACTED] in the interests of justice waives this requirement.

3. Failing resolution by mutual agreement, the aggrieved Party shall document the dispute, disagreement, or misunderstanding by notifying the other Party in writing of the relevant facts, identify unresolved issues, and specify the clarification or remedy sought. Within five (5) working days after providing notice to the other Party, the aggrieved Party may, in writing, request a joint decision by the [REDACTED] Senior Procurement Executive and senior executive appointed by the Performer. The other Party shall submit a written position on the matter(s) in dispute within thirty (30) calendar days after being notified that a decision has been requested. The [REDACTED] and the Performer's appointed senior executive shall conduct a review of the matter(s) in dispute and render a decision in writing within thirty (30) calendar days of receipt of such written position. Any such joint decision is final and binding.

4. In the absence of a joint decision, upon written request to the [REDACTED], made within thirty (30) calendar days of the expiration of the time for a decision under subparagraph B.3 above, the dispute shall be further reviewed. The [REDACTED] may elect to conduct this review personally or through a designee or jointly with a senior executive appointed by the Performer. Following the review, the [REDACTED] or designee will resolve the issue(s) and notify the Parties in writing. Such

[REDACTED]

resolution is not subject to further administrative review and, to the extent permitted by law, shall be final and binding.

C. Limitation of Damages

1. Claims for damages of any nature whatsoever pursued under this Agreement shall be limited to direct damages only up to the aggregate amount of [REDACTED] funding disbursed as of the time the dispute arises. In no event shall [REDACTED] be liable for claims for consequential, punitive, special and incidental damages, claims for lost profits, or other indirect damages.

2. In no event shall either The Performer or the Government be liable to the other for any punitive, exemplary, special, indirect, incidental or consequential damages (including, but not limited to, lost profits, lost business opportunities, loss of use or equipment down time, and loss of or corruption to data) arising out of or relating to this Agreement, regardless of the legal theory under which such damages are sought, and even if the parties have been advised of the possibility of such damages or loss.

Article VIII: PATENT RIGHTS

Allocation of Principal Rights

1. Unless the Performer shall have notified [REDACTED] in accordance with subparagraph B.2 below, that the Performer does not intend to retain title, the Performer shall retain the entire right, title, and interest throughout the world to each Subject Invention consistent with the provisions of this Article.

2. With respect to any Subject Invention in which the Performer retains title, [REDACTED] shall have a nonexclusive, nontransferable, irrevocable, paid-up license to practice or have practiced on behalf of the United States the Subject Invention throughout the world.

Invention Disclosure, Election of Title, and Filing of Patent Application

1. The Performer shall disclose each Subject Invention to [REDACTED] within four (4) months after the inventor discloses it in writing to his company personnel responsible for patent matters. The disclosure to [REDACTED] shall be in the form of a written report and shall identify the Agreement and circumstances under which the Invention was made and the identity of the inventor(s). It shall be sufficiently complete in technical detail to convey a clear understanding, to the extent known at the time of the disclosure, of the nature, purpose, operation, and the physical, chemical, biological, or electrical characteristics of the Invention. The disclosure shall also identify any publication, sale, or public use of the invention and whether a manuscript describing the Invention has been submitted and/or accepted for publication at the time of disclosure.

2. If the Performer determines that it does not intend to retain title to any such Invention, the Performer shall notify [REDACTED], in writing, within eight (8) months of disclosure to [REDACTED]. However, in any case where publication, sale, or public use has initiated the one-year statutory period wherein valid patent protection can still be obtained in the United States, the period for such notice may be shortened by [REDACTED] to a date that is no more than sixty (60) calendar days prior to the end of the statutory period.

3. The Performer shall file its initial patent application on a Subject Invention to which it elects to retain title within one (1) year after election of title or, if earlier, prior to the end of the statutory period wherein valid patent protection can be obtained in the United States after a publication, or sale, or public use. The Performer may elect to file patent applications in additional countries, including the European Patent Office and the Patent Cooperation Treaty, within either ten (10) months of the corresponding initial patent application or six (6) months after the date permission is granted by the Commissioner for Patents to file foreign patent applications, where such filing had previously been prohibited by a Secrecy Order.

[REDACTED]

4. The Performer shall notify [REDACTED] of any decisions not to continue the prosecution of a patent application, pay maintenance fees, or defend in a reexamination or opposition proceedings on a patent, in any country, not less than thirty (30) calendar days before the expiration of the response period required by the relevant patent office.

5. Requests for extension of the time for disclosure election, and filing under Article VII, may be granted at [REDACTED] discretion after considering the circumstances of the Performer and the overall effect of the extension.

6. The Performer shall submit to [REDACTED] annual listings of Subject Inventions. At the completion of the Agreement, the Performer shall submit a comprehensive listing of all subject inventions identified during the course of the Agreement and the current status of each.

Conditions When the Government May Obtain Title

Upon [REDACTED] written request, the performer shall convey title to any Subject Invention to [REDACTED] under any of the following conditions:

1. If the Performer fails to disclose or elects not to retain title to the Subject Invention within the times specified in Paragraph B of this Article; however, [REDACTED] may only request title within sixty (60) calendar days after learning of the failure of the Performer to disclose or elect within the specified times;

2. In those countries in which the Performer fails to file patent applications within the times specified in Paragraph B of this Article; however, if the Performer has filed a patent application in a country after the times specified in Paragraph B of this Article, but prior to its receipt of the written request by [REDACTED], the Performer shall continue to retain title in that country; or

3. In any country in which the Performer decides not to continue the prosecution of any application for, to pay the maintenance fees on, or defend in reexamination or opposition proceedings on, a patent on a Subject Invention.

Minimum Rights to the Performer and Protection of the performer's Right to File

1. The performer shall retain a nonexclusive, royalty-free license throughout the world in each subject invention to which the Government obtains title, except if the Performer fails to disclose the Subject Invention within the times specified in Paragraph B of this Article. The Performer's license extends to its domestic subsidiaries and affiliates, including Canada, if any, and includes the right to grant licenses of the same scope to the extent that the Performer was legally obligated to do so at the time the Agreement was awarded. The license is transferable only with the approval of [REDACTED], except when transferred to the successor of that part of the business to which the Subject Invention pertains. [REDACTED] approval for license transfer shall not be unreasonably withheld.

2. The Performer's domestic may be revoked or modified by [REDACTED] to the extent necessary to achieve expeditious practical application of the Subject Invention pursuant to an application for an exclusive license submitted consistent with appropriate provisions at 37 C.F.R. Part 404. This license shall not be revoked in that field of use or the geographical areas in which the Performer has achieved practical application and continues to make the benefits of the Subject Invention reasonably accessible to the public. The license in any foreign country may be revoked or modified at the discretion of [REDACTED] to the extent the Performer, its licensees, or the subsidiaries or affiliates have failed to achieve practical application in that foreign country.

3. Before revocation or modification of the license, [REDACTED] shall furnish the Performer a written notice of its intention to revoke or modify the license, and the Performer shall be allowed thirty (30) calendar days (or such other time as may be authorized for good cause shown) after the notice to show cause why the license should not be revoked or modified.



Action to Protect the Government's Interest

1. The Performer agrees to execute or to have executed and promptly deliver to [REDACTED] all instruments necessary to (i) establish or confirm the rights the Government has throughout the world in those Subject Inventions to which the Performer elects to retain title, and (ii) convey title to [REDACTED] when requested under Paragraph C of this Article and to enable the Government to obtain patent protection throughout the world in that Subject Invention.

2. The Performer agrees to require by written agreement with its employees, other than clerical and non-technical employees, to disclose promptly in writing to personnel identified as responsible for the administration of patent matters and in a format suggested by the Performer each Subject Invention made under this Agreement in order that the Performer can comply with the disclosure provisions of Paragraph B of this Article. The Performer shall instruct employees, through employee agreements or other suitable educational programs, on the importance of reporting inventions in sufficient time to permit the filing of patent applications prior to United States or foreign statutory bars.

3. The Performer shall include, within the specification of any United States patent application and any patent issuing thereon covering a Subject Invention, the following statement:

This invention was made with Government support under Agreement No. [REDACTED], awarded by [REDACTED]. The Government has certain rights in the invention.

Lower Tier Agreements

The Performer shall include this Article, suitably modified, in all subcontracts or lower tier agreements, regardless of tier, for experimental, developmental, or research work.

Reporting on Utilization of Subject Inventions

1. The Performer agrees to submit, during the term of the Agreement, an annual report on the utilization of a Subject Invention or on efforts at obtaining such utilization that are being made by the Performer or its licensees or assignees. Such reports shall include information regarding the status of development, date of first commercial sale or use, gross royalties received by the Performer, and such other data and information as the agency may reasonably specify. The Performer also agrees to provide additional reports as may be requested by [REDACTED] in connection with any march-in proceedings undertaken by [REDACTED] in accordance with Paragraph I of this Article. [REDACTED] agrees it shall not disclose such information to persons outside the Government without permission of the Performer, unless required by law.

2. All required reporting shall be accomplished, to the extent possible, using the i-Edison reporting website: <https://s-edison.info.nih.gov/iEdison/>. To the extent, any such reporting cannot be carried out by use of i-Edison, reports and communications shall be submitted to the AO and Administrative Agreements Officer (AAO), where one is appointed.

Preference for American Industry

Notwithstanding any other provision of this clause, the Performer agrees that it shall not grant to any person the exclusive right to use or sell any Subject Invention in the United States unless such person agrees that any product embodying the Subject Invention or produced through the use of the subject invention shall be manufactured substantially in the United States. However, in individual cases, the requirements for such an agreement may be waived by [REDACTED] upon a showing by the Performer that reasonable but unsuccessful efforts have been made to grant licenses on similar terms to potential licensees that would be likely to manufacture substantially in the United States or that, under the circumstances, domestic manufacture is not commercially feasible.



March-in Rights

The Performer agrees that, with respect to any subject invention in which it has retained title, [REDACTED] has the right to require the Performer, an assignee, or exclusive licensee of a Subject Invention to grant a nonexclusive license to a responsible applicant or applicants, upon terms that are reasonable under the circumstances, and if the Performer, assignee, or exclusive licensee refuses such a request, [REDACTED] has the right to grant such a license itself if [REDACTED] determines that:

- 1. Such action is necessary because the Performer or assignee has not taken effective steps, consistent with the intent of this Agreement, to achieve practical application of the Subject Invention;
- 2. Such action is necessary to alleviate health or safety needs, which are not reasonably satisfied by the Performer, assignee, or their licensees;
- 3. Such action is necessary to meet requirements for public use and such requirements are not reasonably satisfied by the Performer, assignee, or licensees; or four. Such action is necessary because the agreement required by Paragraph H of this Article has not been obtained or waived or because a licensee of the exclusive right to use or sell any Subject Invention in the United States is in breach of such Agreement.

Article VIII: DATA RIGHTS

Allocation of Principal Rights

1. The Parties agree that in consideration for Government funding, the Performer intends to reduce to practical application items, components and processes developed under this Agreement.

2. With respect to Data developed or generated under this Agreement related to the [REDACTED] the Government shall receive Unlimited Rights, with the exception of the items outlined in Attachment 5, for which either Government Purpose Rights or Limited Rights will apply, as indicated, as defined in Article I, Paragraph B.

3. With respect to Data delivered pursuant to Attachment 2 under the Agreement, the Government shall receive Unlimited Rights, with the exception of the items outlined in Attachment 5, for which either Government Purpose Rights or Limited Rights will apply, as indicated. Notwithstanding the provision in A.4, the performer agrees, with respect to data generated or developed under this Agreement, the Government may, within three (3) years after completion or termination of this Agreement; require delivery of data in accordance with the terms of this Agreement.

4. March-In Rights

(a) In the event the Government chooses to exercise its March-in Rights, as defined in Article VII, Section I of this Agreement, the Performer agrees, upon written request from the Government, to deliver at no additional cost to the Government, all Data necessary to achieve practical application within sixty (60) calendar days from the date of the written request. The Government shall retain Unlimited Rights, as defined in Article I, Section B of this Agreement, to this delivered Data.

(b) To facilitate any potential deliveries, the Performer agrees to retain and maintain in good condition until three (3) years after completion or termination of this Agreement, all Data necessary to achieve practical application of any Subject Invention as defined in Article I, and Section B of this Agreement.



Marking of Data

Pursuant to Paragraph A above, any Data delivered under this Agreement shall be marked with the following legend:

Use, duplication, or disclosure is subject to the restrictions as stated in [redacted] between the Government and the Performer.

Lower Tier Agreements

The Performer shall include this Article, suitably modified to identify the Parties, in all subcontracts or lower tier agreements, regardless of tier, for experimental, developmental, or research work.

Article IX: FOREIGN ACCESS TO TECHNOLOGY

This Article shall remain in effect during the term of the Agreement and for five (5) years thereafter.

General

The Parties agree that research findings and technology developments arising under this Agreement may constitute a significant enhancement to the national defense, and to the economic vitality of the United States. Accordingly, access to important technology developments under this Agreement by Foreign Firms or Institutions must be carefully controlled. The controls contemplated in this Article are in addition to, and are not intended to change or supersede, the provisions of the International Traffic in Arms Regulations (22 C.F.R. Part 120, et seq.), DoD Manual 5220.22, Volume 2 (August 1, 2018), and the Department of Commerce's Export Administration Regulations (15 C.F.R part 730, et seq.).

Restrictions on Sale or Transfer of Technology to Foreign Firms or Institutions

1. In order to promote the national security interests of the United States and to effectuate the policies that underlie the regulations cited above, the procedures stated in subparagraphs B.2, B.3, and B.4 below shall apply to any transfer of Technology. For purposes of this paragraph, a transfer includes a sale of the company, and sales or licensing of Technology. Transfers do not include:

- a. Sales of products or components; or
- b. Licenses of software or documentation related to sales of products or components; or
- c. Transfer to foreign subsidiaries of the Performer for purposes related to this Agreement; or
- d. Transfer which provides access to Technology to a Foreign Firm or Institution which is an approved source

of supply or source for the conduct of research under this Agreement provided that such transfer shall be limited to that necessary to allow the firm or institution to perform its approved role under this Agreement.

2. The Performer shall provide timely notice to [redacted] of any proposed transfers from the Performer of Technology developed under this Agreement to Foreign Firms or Institutions. If [redacted] determines that the transfer may have adverse consequences to the national security interests of the United States, the Performer, its vendors, and [redacted] shall jointly endeavor to find alternatives to the proposed transfer which obviate or mitigate potential adverse consequences of the transfer but which provide substantially equivalent benefits to the Performer.

3. In any event, the Performer shall provide written notice to the [redacted] and the [redacted] of any proposed transfer to a Foreign Firm or Institution at least sixty (60) calendar days prior to the proposed date of transfer. Such notice shall cite this Article and shall state specifically what is to be transferred and the general terms of the transfer. Within thirty (30) calendar days of receipt of the Performer's written notification, the [redacted] shall advise the Performer whether it consents to the proposed transfer. In cases where [redacted] does not concur or sixty (60)

calendar days after receipt and [REDACTED] provides no decision, the Performer may utilize the procedures under Article VI, Disputes. No transfer shall take place until a decision is rendered.

4. In the event a transfer of Technology to Foreign Firms or Institutions which is NOT approved by [REDACTED] takes place, the Performer shall (a) refund to [REDACTED] funds paid for the development of the Technology and (b) the Government shall have a non-exclusive, nontransferable, irrevocable, paid-up license to practice, or to have practiced on behalf of the United States, the Technology throughout the world for Government and any and all other purposes, particularly to effectuate the intent of this Agreement. Upon request of the Government, the Performer shall provide written confirmation of such licenses.

Lower Tier Agreements

The Performer shall include this Article, suitably modified, to identify the Parties, in all subcontracts or lower tier agreements, regardless of tier, for experimental, developmental, or research work.

Article X: SAFEGUARDING CONTROLLED UNCLASSIFIED INFORMATION AND CONTROLLED TECHNICAL INFORMATION AND CYBER INCIDENT REPORTING

Background

Protection of Controlled Unclassified Information (CUI) and Controlled Technical Information (CTI) is of paramount importance to [REDACTED] and can directly impact the ability of [REDACTED] to successfully conduct its mission. Therefore, this Article requires the performer to protect CUI and CTI that resides on the performer's information systems. This article also requires the performer to rapidly report any cyber incident involving CUI or CTI.

Safeguarding CUI and CTI

The performer shall implement the version of NIST Special Publication (SP) 800-171 in effect at the time the solicitation is issued or as authorized by the Agreements Officer for CUI and CTI that resides on the performer's information systems. Consistent with NIST SP 800-171, implementation may be tailored to facilitate equivalent safeguarding measures used in the performer systems and organization. Any suspected loss or compromise of CUI or CTI that resides on the performer's information systems shall be considered a cyber-incident and require the performer to rapidly report the incident to [REDACTED] in accordance with paragraph C below.

Cyber Incident Reporting

Upon discovery of a cyber-incident involving CUI or CTI, the performer shall take immediate steps to mitigate any further loss or compromise. The performer shall rapidly report the incident to [REDACTED] and provide sufficient details of the event-including identification of detected and isolated malicious software-to enable [REDACTED] to assess the situation and provide feedback to the performer regarding further reporting and potential mitigation actions. The performer shall preserve and protect images of all known affected information systems and all relevant monitoring/packet capture data for at least 90 days from reporting the cyber incident to enable [REDACTED] to assess the cyber incident. The performer agrees to rapidly implement security measures as recommended by [REDACTED] and to provide to [REDACTED] any additionally requested information to help the Parties resolve the cyber incident and to prevent future cyber incidents.

Public Release

All information and data covered by this Article must be reviewed and approved by [REDACTED] prior to any public release. The [REDACTED] public release process is governed by [REDACTED]. An online form is available to support those requests at:

[REDACTED]



Lower Tier Agreements

The performer shall include this Article in all subcontracts or lower tier agreements, regardless of tier, for work performed in support of this Agreement.

Definitions

Compromise: Disclosure of information to unauthorized persons, or a violation of the security policy of a system, in which unauthorized intentional or unintentional disclosure, modification, destruction, or loss of an object, or the copying of information to unauthorized media may have occurred.

Controlled Technical Information (CTI): Technical information with military or space application that is subject to controls on the access, use, reproduction, modification, performance, display, release, disclosure, or dissemination. Controlled technical information would meet the criteria, if disseminated, for distribution statements B through F using the criteria set forth in DoD Instruction 5230.24, Distribution Statements on Technical Documents.

Controlled Unclassified Information (CUI): Unclassified information that requires safeguarding or dissemination controls, pursuant to and consistent with applicable law, regulations, and Government-wide policies. Instructions for the use, marking, dissemination, and storage of CUI can be found in DoD Instruction 5200.48. "Controlled Unclassified Information (CUI)."

Cyber Incident: Actions taken through the use of computer networks that result in a compromise or an actual or potentially adverse effect on an information system and/or the information residing therein.

Information System: A discrete set of information resources organized for the collection, processing, maintenance, use, sharing, dissemination, or disposition of information.

Rapidly Report: Report to [REDACTED] within 72 hours of discovery of any cyber incident.

Article XI: FOLLOW-ON PRODUCTION CONTRACTS OR OTHER TRANSACTIONS

In accordance with 10 U.S.C. § 2371b(f), the Government may award a follow-on production contract or Other Transaction (OT) to the Performer, or a recognized successor in interest to the OT, following the successful completion of this entire Agreement, as modified.

Article XII: TITLE TO AND DISPOSITION OF PROPERTY

Title to Property

No significant items of property are expected to be acquired under this Agreement. Title to each item of property acquired under this Agreement with an acquisition value of \$5,000 or less shall vest in the Performer upon acquisition with no further obligation of the Parties unless otherwise determined by the [REDACTED]. Should any item of property with an acquisition value greater than \$5,000 is required, the Performer shall obtain prior written approval of the [REDACTED]. Title to this property shall also vest in the Performer upon acquisition. The Performer shall be responsible for the maintenance, repair, protection, and preservation of all property at its own expense. The performer's deliverable prototype shall not be classified as property.

Disposition of Property

At the completion of the term of this Agreement, items of property with an acquisition value greater than \$5,000 shall be disposed of in the following manner:

[REDACTED]

1. Purchased by the Performer at an agreed-upon price, the price to represent fair market value, with the proceeds of the sale being returned to [REDACTED]; or

2. Transferred to a Government research facility with title and ownership being transferred to the Government; or

3. Donated to a mutually agreed University or technical learning center for research purposes; or

4. Any other [REDACTED]-approved disposition procedure.

Article XIII: CIVIL RIGHTS ACT

This Agreement is subject to the compliance requirements of Title VI of the Civil Rights Act of 1964 as amended (42 U.S.C. § 2000d) relating to nondiscrimination in Federally assisted programs. The Performer has signed an Assurance of Compliance with the nondiscriminatory provisions of the Act.

Article XIV: SECURITY

The Performer shall develop and/or handle classified information in the performance of this Agreement. A DD Form 254 is currently required for this Agreement and is included under Attachment 4.

Article XV: PUBLIC RELEASE OR DISSEMINATION OF INFORMATION

(1) There shall be no dissemination or publication, except within and between the Performer and any subcontractors, of information developed under this Agreement or contained in the reports to be furnished pursuant to this Agreement without prior written approval of the [REDACTED]. All technical reports will be given proper review by appropriate authority to determine which Distribution Statement is to be applied prior to the initial distribution of these reports by the Performer. Unclassified patent related documents are exempt from prepublication controls and this review requirement. There shall be no dissemination or publication, except within and between the Performer and any subcontractor(s), of information developed under this effort without first obtaining approval for public release from the [REDACTED]. Papers prepared in response to academic requirements which are not intended for public release outside the academic institution are exempt from prepublication controls.

(2) The Performer shall submit all proposed public releases for review and approval as instructed at [REDACTED]. Public releases include press releases, specific publicity or advertisement, and publication or presentation, but exclude those relating to the open sourcing or licensing, sales or other commercial exploitation of products, services or technologies. In addition, articles for publication or presentation will contain a statement on the title page worded substantially as follows:

This research was, in part, funded by the U.S. Government. The views and conclusions contained in this document are those of the authors and should not be interpreted as representing the official policies, either expressed or implied, of the U.S. Government.

Article XVI: ORDER OF PRECEDENCE

In the event of any inconsistency between the terms of this Agreement and language set forth in the Attachments, the inconsistency shall be resolved by giving precedence in the following order: (1) The Agreement, and (2) all Attachments to the Agreement.


Article XVII: EXPORT CONTROL

(1) Definition. "Export-controlled items," as used in this clause, means items subject to the Export Administration Regulations (EAR) (15 CFR Parts 730-774) or the International Traffic in Arms Regulations (ITAR) (22 CFR Parts 120-130). The term includes:

A) "Defense items," defined in the Arms Export Control Act, 22 U.S.C. 2778 (j) (4) (A), as defense articles, defense services, and related technical data, and further defined in the ITAR, 22 CFR Part 120.

B) "Items," defined in the FAR as "commodities", "software", and "technology," terms that are also defined in the FAR, 15 CFR 772.1.

(2) The Performer shall comply with all applicable laws and regulations regarding export-controlled items, including, but not limited to, the requirement for Performer to register with the Department of State in accordance with the ITAR. The Performer shall consult with the Department of State regarding any questions relating to compliance with the ITAR and shall consult with the Department of Commerce regarding any questions relating to compliance with the EAR.

(3) The Performer's responsibility to comply with all applicable laws and regulations regarding export controlled items exists independent of, and is not established or limited by, the information provided by this clause.

(4) Nothing in the terms of this contract adds, changes, supersedes, or waives any of the requirements of applicable Federal laws, Executive orders, and regulations, including but not, limited to-

(A) The Export Administration Act of 1979, as amended (50 U.S.C. App. 2401, et seq.);

(B) The Arms Export Control Act (22 U.S.C. 2751, et seq.);

(C) The International Emergency Economic Powers Act (50 U.S.C. 1701, et seq.);

(D) The Export Administration Regulations (15 CFR Parts 730-774);

(E) The International Traffic in Arms Regulations (22 CFR Parts 120-130); and

(F) Executive Order 13222, as extended;

(5) The Performer shall include the substance of this clause, including this paragraph (e), in all sub awards.

Article XVIII: FORCE MAJEURE

The Performer shall not be liable for delays or non-performance hereunder if such delay or nonperformance is from causes beyond the control and without the fault or negligence of the Performer or its subcontractors, and is due, directly, to fire or other casualty; act of God; pandemic; strike or labor dispute; war or other violence, or to acts of the Government in either its sovereign or contractual capacity.

Article XX: APPLICABLE LAW

United States Federal law will apply to the construction, interpretation, and resolution of any disputes arising out of or in connection with this Agreement.

Article XXI: SEVERABILITY

In the event that any one or more of the articles contained herein shall, for any reason, be held to be invalid, illegal or unenforceable in any respect, such invalidity, illegality or unenforceability shall not affect any other articles of this Agreement, but this Agreement shall be construed as if such invalid, illegal or unenforceable articles had never been contained herein, unless the deletion of such article or articles would result in such a material change so as to cause completion of the transactions contemplated herein to be unreasonable.

[REDACTED]

Article XXII: SURVIVAL

The articles covering Definitions, Payments, Records Retention and Government Access, Disputes, Limitation of Damages, Data Rights, Patent Rights, Foreign Access to Technology, Applicable Law, Order of Precedence, Public Release or Dissemination of Information, and Survival, shall survive the completion, termination, or expiration of this Agreement.

Article XXIII: PROHIBITION ON CONTRACTING FOR CERTAIN TELECOMMUNICATIONS AND VIDEO SURVEILLANCE SERVICES OR EQUIPMENT

(a) Definitions. As used in this clause -

Backhaul means intermediate links between the core network, or backbone network, and the small subnetworks at the edge of the network (e.g., connecting cell phones/towers to the core telephone network). Backhaul can be wireless (e.g., microwave) or wired (e.g., fiber optic, coaxial cable, Ethernet).

Covered foreign country means The People's Republic of China.

Covered telecommunications equipment or services means -

(1) Telecommunications equipment produced by Huawei Technologies Company or ZTE Corporation (or any subsidiary or affiliate of such entities);

(2) For the purpose of public safety, security of Government facilities, physical security surveillance of critical infrastructure, and other national security purposes, video surveillance and telecommunications equipment produced by Hytera Communications Corporation, Hangzhou Hikvision Digital Technology Company, or Dahua Technology Company (or any subsidiary or affiliate of such entities);

(3) Telecommunications or video surveillance services provided by such entities or using such equipment; or

(4) Telecommunications or video surveillance equipment or services produced or provided by an entity that the Secretary of Defense, in consultation with the Director of National Intelligence or the Director of the Federal Bureau of Investigation, reasonably believes to be an entity owned or controlled by, or otherwise connected to, the government of a covered foreign country.

Critical technology means-

(1) Defense articles or defense services included on the United States Munitions List set forth in the International Traffic in Arms Regulations under subchapter M of chapter I of title 22, Code of Federal Regulations;

(2) Items included on the Commerce Control List set forth in Supplement No. 1 to part 774 of the Export Administration Regulations under subchapter C of chapter VII of title 15, Code of Federal Regulations, and controlled-

(i) Pursuant to multilateral regimes, including for reasons relating to national security, chemical and biological weapons proliferation, nuclear nonproliferation, or missile technology; or

(ii) For reasons relating to regional stability or surreptitious listening;

(3) Specially designed and prepared nuclear equipment, parts and components, materials, software, and technology covered by part 810 of title 10, Code of Federal Regulations (relating to assistance to foreign atomic energy activities);

(4) Nuclear facilities, equipment, and material covered by part 110 of title 10, Code of Federal Regulations (relating to export and import of nuclear equipment and material);

(5) Select agents and toxins covered by part 331 of title 7, Code of Federal Regulations, part 121 of title 9 of such Code, or part 73 of title 42 of such Code; or

(6) Emerging and foundational technologies controlled pursuant to section 1758 of the Export Control Reform Act of 2018 (50 U.S.C. 4817).

Interconnection arrangements means arrangements governing the physical connection of two or more networks to allow the use of another's network to hand off traffic where it is ultimately delivered (e.g., connection of a

[REDACTED]

customer of telephone provider A to a customer of telephone company B) or sharing data and other information resources.

Reasonable inquiry means an inquiry designed to uncover any information in the entity's possession about the identity of the producer or provider of covered telecommunications equipment or services used by the entity that excludes the need to include an internal or third party audit.

Roaming means cellular communications services (e.g., voice, video, and data) received from a visited network when unable to connect to the facilities of the home network either because signal coverage is too weak or because traffic is too high.

Substantial or essential component means any component necessary for the proper function or performance of a piece of equipment, system, or service.

(b) Prohibition.

(1) Section 889(a)(1)(A) of the John S. McCain National Defense Authorization Act for Fiscal Year 2019 (Pub. L. 115-232) prohibits the head of an executive agency on or after August 13, 2019, from procuring or obtaining, or extending or renewing a contract to procure or obtain, any equipment, system, or service that uses covered telecommunications equipment or services as a substantial or essential component of any system, or as critical technology as part of any system. The Contractor is prohibited from providing to the Government any equipment, system, or service that uses covered telecommunications equipment or services as a substantial or essential component of any system, or as critical technology as part of any system, unless an exception at paragraph (c) of this clause applies or the covered telecommunication equipment or services are covered by a waiver described in FAR 4.2104.

(2) Section 889(a) (1) (B) of the John S. McCain National Defense Authorization Act for Fiscal Year 2019 (Pub. L. 115-232) prohibits the head of an executive agency on or after August 13, 2020, from entering into a contract, or extending or renewing a contract, with an entity that uses any equipment, system, or service that uses covered telecommunications equipment or services as a substantial or essential component of any system, or as critical technology as part of any system, unless an exception at paragraph (c) of this clause applies or the covered telecommunication equipment or services are covered by a waiver described in FAR 4.2104. This prohibition applies to the use of covered telecommunications equipment or services, regardless of whether that use is in performance of work under a Federal contract.

(c) Exceptions. This clause does not prohibit contractors from providing-

(1) A service that connects to the facilities of a third-party, such as backhaul, roaming, or interconnection arrangements; or

(2) Telecommunications equipment that cannot route or redirect user data traffic or permit visibility into any user data or packets that such equipment transmits or otherwise handles.

(d) Reporting requirement.

(1) In the event the Contractor identifies covered telecommunications equipment or services used as a substantial or essential component of any system, or as critical technology as part of any system, during contract performance, or the Contractor is notified of such by a subcontractor at any tier or by any other source, the Contractor shall report the information in paragraph (d)(2) of this clause to the Contracting Officer, unless elsewhere in this contract are established procedures for reporting the information; in the case of the Department of Defense, the Contractor shall report to the website at <https://dibnet.dod.mil> . For indefinite delivery contracts, the Contractor shall report to the Contracting Officer for the indefinite delivery contract and the Contracting Officer(s) for any affected order or, in the case of the Department of Defense, identify both the indefinite delivery contract and any affected orders in the report provided at <https://dibnet.dod.mil>

(2) The Contractor shall report the following information pursuant to paragraph (d) (1) of this clause:

(i) Within one business day from the date of such identification or notification: The contract number; the order number(s), if applicable; supplier name; supplier unique entity identifier (if known); supplier Commercial and Government Entity (CAGE) code (if known); brand; model number (original equipment manufacturer number, manufacturer part number, or wholesaler number); item description; and any readily available information about mitigation actions undertaken or recommended.

[REDACTED]

(ii) Within 10 business days of submitting the information in paragraph (d) (2) (i) of this clause: Any further available information about mitigation actions undertaken or recommended. In addition, the Contractor shall describe the efforts it undertook to prevent use or submission of covered telecommunications equipment or services, and any additional efforts that will be incorporated to prevent future use or submission of covered telecommunications equipment or services.

(e) Subcontracts. The Contractor shall insert the substance of this clause, including this paragraph (e) and excluding paragraph (b)(2), in all subcontracts and other contractual instruments, including subcontracts for the acquisition of commercial items.
(End of clause)

Article XXIV: EXECUTION

This Agreement constitutes the entire agreement of the Parties and supersedes all prior and contemporaneous agreements, understandings, negotiations and discussions among the Parties, whether oral or written, with respect to the subject matter hereof. This Agreement may be revised only by written consent of the Performer and the [REDACTED]. This Agreement, or modifications thereto, may be executed in counterparts each of which shall be deemed as original, but all of which taken together shall constitute one and the same instrument.

REPORT REQUIREMENTS

[REDACTED] All reports required by this Agreement shall be digitally uploaded into the [REDACTED] in addition to any other submission requirements. The [REDACTED] can be accessed at [REDACTED]

On or before ninety (90) calendar days after the effective date of the Agreement and thereafter throughout the term of the Agreement, the Performer shall submit or otherwise provide a report. One (1) copy shall be submitted or otherwise provided to the [REDACTED], one (1) copy shall be submitted or otherwise provided to the [REDACTED], one (1) copy shall be submitted or otherwise provided to [REDACTED] and one (1) copy shall be digitally uploaded into the [REDACTED]. The report will have two (2) major sections.

Technical Status Report. The technical status report will detail technical progress to date and report on all problems, technical issues, major developments, and the status of external collaborations during the reporting period.

Business Status Report. The business status report shall provide summarized details of the resource status of this Agreement, including the status of the Performer contributions. This report will include an accounting of current expenditures as outlined in the Annual Program Plan. Any major deviations, over plus or minus 10%, shall be explained along with discussions of the adjustment actions proposed. The report will also include an accounting of any interest earned on Government funds. The Performer is reminded that interest in amounts greater than Two hundred Fifty Dollars (\$250.00) per year is not expected to accrue under this Agreement. In the event that this interest does accrue on Government funds, the Performer is required to provide an explanation for the accrual in the business report. Depending on the circumstances, the Payable Milestones may require adjustment.

ANNUAL PROGRAM PLAN DOCUMENT

The Performer shall submit or otherwise provide to the [REDACTED], [REDACTED] PM, and [REDACTED] and digitally upload into the [REDACTED] tool, one (1) copy each of a report which describes the Annual Program Plan as described in Article III, Section B.

SPECIAL TECHNICAL REPORTS

As agreed to by the Performer and the [REDACTED], the Performer shall submit or otherwise provide to the [REDACTED], [REDACTED] PM, and [REDACTED] and digitally upload into the [REDACTED] tool, one (1) copy each of special reports



on significant events such as significant target accomplishments by the Performer, significant tests, experiments, or symposia.

MILESTONE REPORTS

The Performer shall submit or otherwise provide to the [REDACTED] and [REDACTED] and digitally upload into the [REDACTED] tool, documentation describing the extent of accomplishment of Payable Milestones. This information shall be as required by Article V, Paragraph B and shall be sufficient for the [REDACTED] to reasonably verify the accomplishment of the milestone of the event in accordance with the TDD.

FINAL REPORT

(NOTE: The Final Report is included in the last Payable Milestone for the completed Agreement.)

1. The Performer shall submit or otherwise provide a Final Report making full disclosure of all major developments by the Performer upon completion of the Agreement or within sixty (60) calendar days of termination of this Agreement. One (1) copy shall be submitted or otherwise provided to the [REDACTED] one (1) copy shall be submitted or otherwise provided to the [REDACTED] one (1) copy shall be submitted or otherwise provided to the [REDACTED] and one (1) copy shall be submitted to the [REDACTED] at [REDACTED]. One (1) copy shall be submitted to the [REDACTED].

2. Prior to delivery, the Performer shall consult with the [REDACTED] to determine the proper distribution statement to be included on the front page of the final report in a conspicuous place.

EXECUTIVE SUMMARY

The Performer shall submit a one to two page executive-level summary of the major accomplishments of the Agreement and the benefits of using the other transactions authority pursuant to 10 U.S.C. § 2371b upon completion of the Agreement. This summary shall include a discussion of the actual or planned benefits of the technologies for both the military and commercial sectors. One (1) copy shall be submitted to the [REDACTED] and one (1) copy shall be digitally uploaded into the [REDACTED].

SUPPLIER REPRESENTATIONS AND CERTIFICATIONS

Applicable to Federal orders > \$30,000

INSTRUCTIONS

The Procurement professional shall complete this section to indicate the applicability of certifications based on Prime Contract, higher-level subcontract, and/or anticipated award requirements. These Representations and Certifications are solicitation specific and may not be reused on subsequent offers by the Offeror. Offeror must use the table below to identify which sections are required for completion. Any sections identified as "All" or checked should be completed in their entirety to include subsections, as applicable. If you have any questions, please contact your Procurement professional POC.

Prime Solicitation/Contract No.:

Section	Applicability	Requirement Description	Exceptions
1		General Information	
1.1	A	Legal Entity Information	N/A
1.2	When Parent Exists	Parent Company	N/A
1.3	As Required by SOW	Security Information	N/A
2		General Certifications	
2.1	A	NAICS Code and Classification	N/A
2.2	A	Anti-Lobbying Certification (52.203-11)	<\$150k
2.3	A	Certain Telecommunications and Video Surveillance Services and Equipment (52.204-24)	N/A
2.4	A	Debarment Certification (52.209-6)	<\$35k or COTS
2.5	A	Previous Contracts and Compliance Reports (52.222-22)	N/A
2.6	A	Affirmative Action Compliance (52.222-25)	N/A
2.7	A	Certifications for the Delivery of Supplies	Delivery of services only
		Certificates	Provision for Certification
2.7.1	<input type="checkbox"/> 52.225-1	Buy American-Supplies	52.225-2
	<input type="checkbox"/> 52.225-3 ALT	Buy American-Free Trade Agreements-Israel Trade Act	52.225-4 ALT
	<input type="checkbox"/> 252.225-7001	Buy American-Balance of Payments Program	252.225-7000
2.7.2	<input type="checkbox"/> 52.225-5	Trade Agreements	52.225-6
	<input type="checkbox"/> 252.225-7021	Trade Agreements	252.225-7020
2.8	A	Property	N/A
2.9	<input type="checkbox"/> 52.204-10	Reporting Executive Compensation of First Tier Subcontracts	<\$30k
2.10	<input type="checkbox"/> 52.222-50	Combating Trafficking in Persons	<\$550k, COTS, Acquisition / Performance in the US
3		Certifications for the Delivery of Services	Delivery of supplies only
3.1	A	Certification of Minimum Labor Category Requirements	FFP or Cost Reimbursable
3.2	A	Organizational Conflict of Interest	N/A
3.3	A	Accounting System	FFP or Commercial Item(s)/ Service(s)
4	<input type="checkbox"/> 52.230-2	Cost Accounting Standards	48 CFR 9903.201-1
5	All >\$750k & COTS Exemptions	Commercial Item(s) and/or Service(s)	Non-commercial item(s)/ service(s)

SUPPLIER REPRESENTATIONS AND CERTIFICATIONS

Applicable to a Federal orders > \$30,000

Certain representations must be made by the Offeror and submitted for acquisitions under U.S. Government Contracts. The signature by an authorized agent of the Offeror in the last section of this document constitutes the execution of applicable representations & certifications. A FAR references and terms shall be used in the context as defined by the current version of the [FAR](#).

SECTION 1 – GENERAL INFORMATION				
1.1	LEGAL ENTITY NAME Houston Mechatronics, Inc.			CAGE CODE 7LK31
	STREET ADDRESS 17146 Feathercraft Ln, Suite 450			CITY Webster
	STATE TX	ZIP CODE 77598-4401	COUNTRY USA	DUNS NUMBER 079574594
1.2	Parent Company Offeror shall disclose a parent companies. If more details required, provide in an attachment.			
	PARENT COMPANY NAME N/A			
	PARENT COMPANY STREET ADDRESS			CITY
	STATE	ZIP CODE	COUNTRY	DUNS NUMBER
1.3	Security Information Complete if the anticipated performance includes security requirements per the SOW.			
	SECURITY POC NAME Reginald B Berka	PHONE 281-942-9069	FAX	EMAIL RBERKA@HOUSTONMECHATRONICS.COM
	PHYSICAL STREET ADDRESS <input checked="" type="checkbox"/> SAME AS LEGAL ENTITY ADDRESS PROVIDED HEREIN			CITY
	STATE	ZIP CODE	DOES OFFEROR REQUIRE A SPONSORED FACILITY CLEARANCE?	<input checked="" type="checkbox"/> Yes <input type="checkbox"/> No

SUPPLIER REPRESENTATIONS AND CERTIFICATIONS

Applicable to Federal orders > \$30,000

SECTION 2 – GENERAL CERTIFICATIONS

2.1 NAICS Code and Classification

2.1.1 Offeror's NAICS code for the predominance of the work contemplated by the Offeror's proposals: 541330; and the associated business size standard is: SBA

2.1.2 Select all that apply to the Offeror using the SBA's small business size standards for the above NAICS code:

- Large Business, Small Business, Foreign, etc. checkboxes

Under 15 U.S.C. 645(d) any person who misrepresents its size status shall (1) be punished by a fine, imprisonment or both; (2) be subject to administrative remedies; and (3) be ineligible for participation in programs conducted under the authority of the Small Business Act

2.2 Certification & Disclosure Regarding Payments to Influence Certain Federal Transactions

Reference FAR 52.203.11. Select one:

- Offeror is exempt from certifying as the anticipated award value is <\$150k (including options).
Offeror hereby certifies to the best of its knowledge and belief that no Federal appropriated funds have been paid or will be paid to any person for influencing or attempting to influence an officer or employee of any agency, a Member of Congress, an officer or employee of Congress, or an employee of a Member of Congress on its behalf in connection with the awarding of this subcontract. DISCLOSURE. If any registrants under the Lobbying Disclosure Act of 1995 have made a lobbying contact on behalf of the Offeror with respect to this subcontract, the Offeror shall complete and submit, with its offer, OMB Standard Form LLL, Disclosure of Lobbying Activities, to provide the name of the registrants. The Offeror need not report regulatory employees or employees of the Offeror to whom payments of reasonable compensation were made.

2.3 Certification Regarding Certain Telecommunications and Video Surveillance Services and Equipment

Reference FAR 52.204-24

The Offeror represents that it will not provide covered telecommunications equipment or services to the government in the performance of any contract, subcontract or other contractual instrument resulting from this solicitation.

The Offeror represents that it will provide covered telecommunications equipment or services to the government in the performance of any contract, subcontract or other contractual instrument resulting from this solicitation.

If the Offeror has responded affirmatively to above, the Offeror shall provide the following information as part of its offer.

- A covered telecommunications equipment and services offered (include brand; model number, such as original equipment manufacturer (OEM) number, manufacturer part number, or manufacturer number; and item description, as applicable);
Explanation of the proposed use of covered telecommunications and services and any factors relevant to determining if such use would be permissible under the prohibition in paragraph (b) of 52.204-24;
For services, the entity providing the covered telecommunications services (include entity name, unique entity identifier, and Commercial and Government Entity (CAGE) code, if known); and
For equipment, the entity that produced the covered telecommunications equipment (include entity name, unique entity identifier, CAGE code, and whether entity was the OEM or a distributor, if known).

2.4 Debarment Certification – Reference FAR 52.209-6. Select One:

- Offeror is exempt from certification as its proposals <\$35k; or Offeror's proposals for the delivery of COTS items only as defined by the FAR (Offeror must complete section 5).
Offeror certifies that neither the organization nor any of its Principals are presently debarred, suspended, proposed for debarment, or declared ineligible for the award of contracts by any Federal agency.

2.5 Equal Opportunity: Previous Contracts and Compliance Reports – Reference FAR 52.222-22. Select one:

SUPPLIER REPRESENTATIONS AND CERTIFICATIONS

Applicable to a Federal orders > \$30,000

- Offeror **has** participated in a previous contract (or subcontract) subject to the Equal Opportunity clause of this solicitation and has filed a required compliance report.
- Offeror **has not** participated in a previous contract or subcontract subject to the Equal Opportunity clause.

2.6 Affirmative Action Compliance – Reference [FAR 52.222-25](#). Select one:

- Offeror **certifies** that it has developed and has on file at each establishment, affirmative action programs required by the rules and regulations of the Secretary of Labor (41 CFR 60-1 and 60-2).
- Offeror **has not** previously had contracts subject to the written affirmative action program requirement of the rules and regulations of the Secretary of Labor.

2.7 Certifications for the Delivery of Supplies.

- N/A. Offeror's proposal does not include the delivery of Supplies. **Skip to Section 2.8.**
- N/A. FAR 52.225-1, 3, or 5 and DFARS 252.225-7001 or 7021 are not identified on the Instruction sheet as applicable to the solicitation. Skip to Section 2.8.

2.7.1 Buy American

- The item(s) proposed meet the exception for Information Technology that is a commercial item (as defined in FAR 2.101) as specified in FAR 25.103(e).
- The item(s) proposed **do not** meet the exception for Information Technology that is a commercial item (as defined in FAR 2.101) as specified in FAR 25.103(e). Therefore, Offeror certifies that each item proposed complies with the BAA provisions/causes selected in the instructions.
- If applicable, Offeror has attached certificate(s) in accordance with the provision(s) selected in the instructions.

2.7.2 Trade Agreements

- The item(s) proposed are for arms, ammunition, or war materias, or purchases indispensable for national security or for national defense purposes and meet the exception as specified in FAR 25.401(a)(2).
- The item(s) proposed are end products (as defined in FAR 25.003) for resale and meet the exception as specified in FAR 25.401(a)(3).
- The Offeror is Federal Prison Industries, Inc. and meets the exception as specified in FAR 25.401(a)(4).
- The item(s) proposed **do not** meet one of the exceptions stated above as specified in FAR 25.401(a)(2)-(4). Therefore, Offeror certifies that each item proposed complies with the TAA provisions/causes selected in the instructions.
- If applicable, Offeror has attached certificate(s) in accordance with the provision(s) selected in the instructions.

2.8 Property Selection that apply to Offeror's anticipated performance:

- Offeror will not acquire or be furnished government/customer property during performance. **Skip to Section 2.9.**
- Offeror will be furnished government/customer equipment, material or sensitive property.
- Offeror will acquire equipment or materials on a cost reimbursable basis (CPXX or T&M) or other terms resulting in government/customer property (title vests to government/customer).
- Offeror will fabricate equipment or material, special test equipment or special test equipment.
- Offeror has a Government approved property management system as evidenced by an attached copy of the most recent approveter (required for approved systems).

2.9 Reporting Executive Compensation & First Tier Subcontract Awards

In accordance with FAR 52.204-10, unless an exemption is claimed by the offeror, Leidos must report the total compensation of the five most highly compensated executives of first-tier subcontractors when the value of the subcontract is >\$30,000. When required, reported data will be available on www.usaspending.gov.

Applicability (Select one):

- N/A. 52.204-10 is not identified on the Instructions sheet as applicable to the solicitation. **Skip to Section 2.10.**
- Offeror is exempt from FAR 52.204-10 reporting requirements because its award is <\$30k. **Skip to Section 2.10.**
- Leidos is exempt from reporting the anticipated award because the Offeror's annual gross income from all sources in the previous tax year is <\$300k. Skip to Section 2.10.
- The Offeror is exempt from providing the executive compensation information because it received <\$25M or <80% of its annual gross revenues from Federal contracts (and subcontracts), loans, grants (and subgrants), cooperative agreements, and other forms of federal financial assistance in the preceding fiscal year. Skip to Section 2.10.
- The public has access to information about the compensation of the Offeror's executives through periodic reports filed under section 13(a) or 15(d) of the Securities Exchange Act of 1934 (15 U.S.C. 78m(a), 78o(d)) or section 6104 of the Internal Revenue Code of 1986. Skip to Section 2.10.

SUPPLIER REPRESENTATIONS AND CERTIFICATIONS

Applicable to Federal orders > \$30,000

2.9.1 Unless any of the above terms apply, Leidos must report the data required by FAR 52.204-10(d)(2). Therefore, the Offeror is required to enter the information required by FAR 52.204-10(d)(3) into the SAM registration.

- Offeror certifies that the registration under the following DUNS number: _____ in SAM is complete which includes a mandatory information required by FFATA. Offeror further agrees to maintain its SAM record to be current by submission of this certification, prior to award, during performance, and through final payment from any resulting award.

2.10 Combatting Trafficking in Persons – Reference FAR 52.222-50. Select one:

- N/A. 52.222-50 is not identified on the instructions sheet as applicable to the solicitation. **Skip to Section 3.**

- Offeror is exempt from certification as its anticipated order is <\$550k. If selected, **Skip to Section 3.**

The anticipated order is >=\$550k, however the Offeror is exempt from certification because:

- The supplies proposed are COTS (skip to Section 3. Offeror must, also, complete section 5), or

- A supplies or services proposed will be acquired or performed within the United States (**Skip to Section 3**).

- Offeror is aware of and currently in compliance with all of the requirements of 52.222-50, Combatting Trafficking in Persons, to prevent any prohibited activities and to monitor, detect, and terminate a contract with any second-tier subcontractor engaging in prohibited activities. Offeror has conducted due diligence, and certifies that either () To the best of the Offeror's knowledge and belief, neither it nor any of its proposed agents, subcontractors, or the agents engaged in any such activities identified in 52.222-50(b); or () If abuses relating to any of the prohibited activities have been found, the Offeror or proposed subcontractor has taken the appropriate remedial and referral actions. Further, the Offeror shall certify to the previous annually after receiving an award.

SECTION 3 - CERTIFICATIONS FOR THE DELIVERY OF SERVICES

- N/A. Offeror's proposal does not include the delivery of Services. (If selected, Offeror may **Skip to Section 4.**)

3.1 Certification of Minimum Labor Category Requirements

- N/A. Offeror's proposals for other than Time and Materials/Labor Hour or Fixed Price/Level-of-Effort. **Skip to Section 3.2.**

- Offeror certifies: 1) to maintain records and adhere to documented procedures for verifying the education, employment, censusing and/or professional certification background of all employees including employees designated to perform on a subcontract resulting from this RFP; 2) to maintain records of all employee background verifications performed under the anticipated subcontract and such documented verifications will be provided to Leidos immediately upon request; and 3) that any individual proposed or bid to Leidos shall meet the minimum labor category requirements required by the solicitation and resulting subcontract.

3.2 Organizational Conflict of Interest

This certification is required to ensure OCIs do not exist for the anticipated performance of the award; or that any potential OCI is identified, neutralized or mitigated when necessary. **Select one:**

- Offeror hereby certifies that Offeror's performance of its obligations under any subcontract that may be issued as a result of this RFP will not be biased because of its financial, contractual, organizational or other interests which relate to the proposed work; Offeror will be able to render impartial, technically sound, and objective assistance or advice; and Offeror will not obtain any unfair competitive advantage over other parties by virtue of its performance of the proposed subcontract.

- Offeror hereby certifies that the circumstances as to why Offeror cannot make the foregoing "OCI Representation" certification are fully disclosed on the attached page(s) and reflect: The category of conflict (organizational, contractual, and/or financial); The company, agency, organization in which you have a past, present, or currently planned interest or activity (financial, contractual, organizational, or otherwise); A brief description of relationship; A period of relationship; and the extent of relationship (e.g., value of financial interest of work; percent of total holdings, total work)

SUPPLIER REPRESENTATIONS AND CERTIFICATIONS

Applicable to Federal orders > \$30,000

3.3 Accounting System

The information collected for this certification shall determine adequacy of Offeror's Accounting System in accordance with FAR 52.216-7 and 252.242-7006, and eligibility for award of a cost-reimbursement or a time-and-materials type subcontract where indirect rates will apply. Complete all subsections by selecting a that apply to the current state of Offeror's accounting system:

Applicability (Select one):

- Offeror's proposal includes the delivery of services but is contemplated as a Firm Fixed Price or Labor-Hour (e.g., no anticipated travel, material, etc.) type subcontract or is for commercial items/services (Offeror must complete Section 5) award. **Skip to Section 4.**
- Offeror's proposal does not qualify for either of the aforementioned exemptions and will be required to complete subsections 3.3.1 and 3.3.2 (see instructions in 3.3.2 below).
- Offeror's proposal includes the delivery of services and is contemplated as a Time and Material type subcontract. However, Offeror either is not current on submission of Incurred Cost Submissions required by FAR 52.216-7 or does not have an adequate accounting system (i.e., provided evidence of government approval) and therefore Offeror acknowledges that indirect burdens may not be applied to any ODCs in the resultant subcontract. **Skip to Section 4.**

3.3.1 Incurred Cost Submission Compliance 52.216-7. Select & complete to certify:

- Offeror's current and submits, at least on an annual basis, incurred cost proposals to the appropriate Government auditing agency as provided below. Further, Offeror will maintain compliance with FAR 52.216-7 submissions of incurred cost proposals for each fiscal year during performance where applicable indirect rates are applied to bills. Offeror shall immediately adjust any bills to reflect upon receipt of any applicable rate adjustments made by the cognate auditing agency. The incurred cost proposals will be submitted to:

Agency Name:	DCAA
Agency Address:	12650 Featherwood Dr, Suite 250, Houston, TX 77034
Auditor Name:	Ch Hoang
Auditor Phone:	281-464-1800
Auditor Email:	ch.hoang@dcaa.m

3.3.2 Accounting System Approval Status

- Offeror's accounting system has been approved (or deemed adequate) by a Government agency within the last 3 years and the system remains in an "Approved" status. Offeror shall attach a copy of the aforementioned approval and/or system approval letter(s) with submission of this form. If system is approved and approvals provided, **Skip to Section 4.**
- Offeror's accounting system has been approved (or deemed adequate) by a Government agency, but the approval letter is > 3 years, Offeror shall provide a copy of the approval letter and the Offeror is required to complete subsection 3.3.3.

3.3.3 Accounting System Checklist (All elements must be selected to establish adequacy of Offeror's system)

- Offeror's Accounting System is currently in full operation and provides for:
 - Proper segregation of direct costs from indirect costs; and identification and accumulation of direct costs by contract;
 - A logical and consistent method for the allocation of indirect costs to intermediate and final cost objectives (a contract as a final cost objective);

[REDACTED]

SUPPLIER REPRESENTATIONS AND CERTIFICATIONS

Applicable to Federal orders > \$30,000

- Accumulation of costs under general ledger control; and reconciliation of subsidiary cost ledgers and cost objectives to general ledger;
- Approval and documentation of adjusting entries; and management reviews or internal audits of the system to ensure compliance with established policies, procedures, and accounting practices;
- A timekeeping system that identifies employees labor by intermedial or final cost objectives; and a labor distribution system that charges direct and indirect labor to appropriate cost objectives;
- Interim (at least monthly) determination of costs charged to a contract through routine posting of books of account;
- Exclusion from costs charged to government contracts of amounts, which are not allowable in terms of FAR 31, Contract Cost Principles and Procedures, or other contract provisions;
- Identification of costs by contract item and by units (as if each unit or item were a separate contract) if required by the proposed contract;
- Segregation of preproduction costs from production costs if production costs are applicable to Offeror's organization; or production costs are not applicable to Offeror's organization;
- Cost accounting information required by contract clauses concerning material cost (FAR 52.232-20 and 22); material on payments (FAR 52.216-16); or allowable cost and payment (FAR 52.216-7); information to readily calculate indirect cost rates from the books of accounts; and information required to support requests for progress payment;
- Billing that can be reconciled to the cost accounts for both current and cumulative amounts commensurate and comply with subcontract terms; and provide timely notification to the Government of overpayments/underpayments;
- Adequate, reliable data for use in pricing follow-on acquisitions;
- Segregation of incurred costs that may be non-billable because the costs may not meet specified criteria; and identifies costs that require specific approvals (special purchases, overtime, etc.);
- Adjusting submissions for final rates or indirect billing rates that differ from the billed rates; and
- Accounting practices in accordance with standards promulgated by the Cost Accounting Standards Board, if applicable, otherwise, Generally Accepted Accounting Principles.

SECTION 4 - CAS CERTIFICATIONS

4.1 CAS EXEMPTIONS. Select one of the below (if applicable. If an exemption applies, Offeror is to **Skip to section 5**)

- Anticipated award is a negotiated type subcontract <\$2M
- Offeror is a small business concern under the performing NAICS code 541330
- Proposed prices set by law or regulation
- Proposed pricing is for commercial items only as defined by FAR 2.101 (**Offeror must complete Section 5**)
- <\$7.5M (total value including options) and at the time of award, Offeror's business unit will not currently be performing any CAS-covered contracts or subcontracts valued at >\$7.5M
- Anticipated award will be firm-fixed-price and awarded on the basis of adequate price competition without submissions of cost or pricing data
- Certificate of Monetary Exemption.** The Offeror hereby certifies that the Offeror, together with divisions, subsidiaries, and affiliates under common control, did not receive net awards of negotiated prime contracts and subcontracts subject to CAS totaling \$50 million or more in the cost accounting period immediately preceding the period in which this proposal was submitted. The Offeror further certifies that if such status changes before an award resulting from this proposal, the Offeror will advise the Contracting Officer immediately.
- Certificate of Interim Exemption.** The Offeror hereby certifies that () the Offeror first exceeded the monetary exemption for disclosure, as defined above, in the cost accounting period immediately preceding the period in which this offer was submitted and () in accordance with 9903.202-1, the Offeror is not yet required to submit a Disclosure Statement. The Offeror further certifies that if an award resulting from this proposal has not been made within 90 days after the end of that period, the Offeror will immediately submit a revised certificate to the Contracting Officer, in the form specified under subparagraph (c)(1) or (c)(2) of Part (1) of this provision, as appropriate, to verify submission of a completed Disclosure Statement. **CAUTION:** Offeror currently required to disclose because they were awarded a CAS-covered prime contract or subcontract of \$50 million or more in the current cost accounting period may not claim this exemption. Further, the exemption applies only in connection with proposals submitted before expiration of the 90-day period following the cost accounting period in which the monetary exemption was exceeded.

SUPPLIER REPRESENTATIONS AND CERTIFICATIONS

Applicable to Federal orders > \$30,000

SECTION 4 - CAS CERTIFICATIONS

4.2 DISCLOSURE STATEMENT – COST ACCOUNTING PRACTICES AND CERTIFICATIONS 52.230-1

Cost Accounting Standards shall apply to any negotiated subcontract not exempt in accordance with 48 CFR 9903.201-1(b). Offeror shall examine each part and provide the requested information in order to determine Cost Accounting Standards (CAS) requirements applicable to any resultant subcontract. Any Offeror submitting a proposal that, if accepted, will result in a subcontract subject to the requirements of 48 CFR, chapter 99, must, as a condition of contracting, submit a Disclosure Statement as required by 9903.202. When required, the Disclosure Statement must be submitted as a part of the Offeror's proposal under this solicitation unless the Offeror has already submitted a Disclosure Statement disclosing the practices used in connection with the pricing of this proposal. If an applicable Disclosure Statement has already been submitted, the Offeror may satisfy the requirement for submission by providing the information requested in paragraph (c) of Part (1) of this provision.

Caution: In the absence of specific regulations or agreement, a practice disclosed in a Disclosure Statement shall not, by virtue of such disclosure, be deemed to be a proper, approved, or agreed-to practice for pricing proposals or accumulating and reporting contract performance cost data.

Select one as applicable to Offeror's Disclosure Statement:

- Certificate of Concurrent Submission of Disclosure Statement.** The Offeror hereby certifies that, as a part of the offer, copies of the Disclosure Statement have been submitted as follows: () Original and one copy to the cognizant Administrative Contracting Officer (ACO) or cognizant Federal agency official authorized to act in that capacity, as applicable, and () one copy to the cognizant Federal auditor. Disclosure must be on Form No. CASB DS-1 or CASB DS-2, as applicable. Forms may be obtained from the cognizant ACO or cognizant Federal agency official acting in that capacity and/or from the appropriate version of the Federal Acquisition Regulation. The Offeror further certifies that the practices used in estimating costs in pricing this proposal are consistent with the cost accounting practices disclosed in the Disclosure Statement.

Date of Disclosure Statement: _____
Name of Federal Official: _____
Address where filed: _____

- Certificate of Previously Submitted Disclosure Statement.** The Offeror certifies that the practices used in estimating costs in pricing this proposal are consistent with the cost accounting practices disclosed in the applicable Disclosure Statement. The Offeror hereby certifies that the required Disclosure Statement was filed as follows:

Date of Disclosure Statement: _____
Name of Federal Official: _____
Address where filed: _____

SUPPLIER REPRESENTATIONS AND CERTIFICATIONS

Applicable to Federal orders > \$30,000

4.3 COST ACCOUNTING STANDARDS—ELIGIBILITY FOR MODIFIED CONTACT COVERAGE 52.230-1

If the Offeror seeks to use the modified provisions of 9903.201-2(b) and elects to do so, the Offeror shall indicate by checking the box below. Checking the box below shall mean that the resultant subcontract is subject to the Disclosure and Consistency of Cost Accounting Practices clause in lieu of the Cost Accounting Standards clause. If the Offeror is an educational institution, this subsection does not apply unless the contemplated subcontract will be subject to full or modified CAS coverage pursuant to 48 CFR 9903.201-2(c)(5) or 9903.201-2(c)(6), respectively. Select one.

Disclosure and Consistency of Cost Accounting Practices. The Offeror hereby claims an exemption from the Cost Accounting Standards clause under the provisions of 9903.201-2(b) and certifies that the Offeror seeks to use of the Disclosure and Consistency of Cost Accounting Practices clause because during the cost accounting period immediately preceding the period in which this proposal was submitted, the Offeror received less than \$50 million in awards of CAS-covered prime contracts and subcontracts. The Offeror further certifies that if such status changes before an award resulting from this proposal, the Offeror will advise Leidos immediately.

CAUTION: Offeror may not claim the eligibility for modified contract coverage if this proposal is expected to result in the award of a CAS-covered contract of \$50 million or more or, during its current cost accounting period, the Offeror has been awarded a single CAS-covered prime contract or subcontract of \$50 million or more.

Modified Cost Accounting Standards Coverage by an Educational Institution. Offeror hereby certifies that as an educational institution that will not use a Federally Funded Research and Development Center (FFRDC) operated by it to perform the work for this contract. Offer further certifies that as an educational institution eligible for coverage under CFR 9903.201-2 (c), CAS coverage shall be pursuant to FAR 52.230-5 rather than FAR 52.230-2.

Modified Cost Accounting Standards Coverage by a Foreign Concern. Offeror hereby certifies that as eligible for exemption from CAS Coverage as a foreign concern. Any resultant subcontract shall comply with CAS Standards found in 48 CFR 9904.401 and 48 CFR 9904.402. Offeror shall disclose actual cost accounting practices, and follow consistent disclosed and established cost accounting practices. CAS coverage shall be pursuant to FAR 52.230-4.

4.4 ADDITIONAL COST ACCOUNTING STANDARDS APPLICABLE TO EXISTING CONTRACTS 52.230-1

The Offeror shall indicate below whether award of the contemplated subcontract would, in accordance with subparagraph (a)(3) of the Cost Accounting Standards clause, require a change in established cost accounting practices affecting existing contracts and subcontracts.

- Yes
- No

4.5 PROPOSAL DISCLOSURE – COST ACCOUNTING PRACTICE CHANGES 52.230-7

SUPPLIER REPRESENTATIONS AND CERTIFICATIONS

Applicable to Federal orders > \$30,000

The subcontract award will result in a required or unanticipated change in Offeror's cost accounting practice, including unanticipated changes requested to be described changes.

- Yes. The Offeror shall (1) Prepare the price proposal in response to the solicitation using the changed practice for the period of performance for which the practice will be used; and (2) Submit a description of the changed cost accounting practice to the Contracting Officer and the Cognizant Federal Agency Official as pricing support for the proposal.
- No

SECTION 5 – COMMERCIAL ITEM CERTIFICATION

5.1 When the proposal is >\$750,000 or the Offeror is claiming exemption to the Debarment or Trafficking in Persons certification requirements because the Offeror is providing COTS items, Offeror shall make an assertion for whether the items/services proposed meet the following FAR Part 2.101 definition(s).

N/A, proposed item(s) and/or service(s) are non-commercial

When proposed item(s) and/or service(s) are being asserted as commercial, Offeror must check the box that most closely applies and shall provide technical data for items asserted as similar to, or commercial items that are "of a type" or requiring minor modifications:

"Commercial Item" Means-

- (1) Any item, other than real property, that is of a type customarily used by the general public or by non-governmental entities for purposes other than governmental purposes, and
- () Has been sold, leased, or licensed to the general public; or
 - () Has been offered for sale, lease, or license to the general public;
- (2) Any item that evolved from an item described in paragraph (1) of this definition through advances in technology or performance and that is not yet available in the commercial marketplace, but will be available in the commercial marketplace in time to satisfy the delivery requirements under a Government solicitation;
- (3) Any item that would satisfy a criterion expressed in paragraphs (1) or (2) of this definition, but for
- () Modifications of a type customarily available in the commercial marketplace; or
 - () Minor modifications of a type not customarily available in the commercial marketplace made to meet Federal Government requirements. Minor modifications means modifications that do not significantly alter the nongovernmental function or essential physical characteristics of an item or component, or change the purpose of a process. Factors to be considered in determining whether a modification is minor include the value and size of the modification and the comparative value and size of the final product. Dollar values and percentages may be used as guides, but are not conclusive evidence that a modification is minor;
- (4) Any combination of items meeting the requirements of paragraphs (1), (2), (3), or (5) of this definition that are of a type customarily combined and sold in combination to the general public;
- (5) Installation services, maintenance services, repair services, training services, and other services
- () Such services are procured for support of an item referred to in paragraph (1), (2), (3), or (4) of this definition, regardless of whether such services are provided by the same source or at the same time as the item; and
 - () The source of such services provides similar services contemporaneously to the general public under terms and conditions similar to those offered to the Federal Government;
- (6) Services of a type offered and sold competitively in substantial quantities in the commercial marketplace based on established catalog or market prices for specific tasks performed or specific outcomes to be achieved and under standard commercial terms and conditions. For purposes of these services
- () "Catalog price" means a price included in a catalog, price list, schedule, or other form that is regularly maintained by the manufacturer or vendor, is either published or otherwise available for inspection by customers, and states prices at which sales are current, or were last, made to a significant number of buyers constituting the general public; and

SUPPLIER REPRESENTATIONS AND CERTIFICATIONS

Applicable to Federal orders > \$30,000

() "Market prices" means current prices that are established in the course of ordinary trade between buyers and sellers free to bargain and that can be substantiated through competition or from sources independent of the offerors.

(7) Any term, combination of terms, or service referred to in paragraphs (1) through (6) of this definition, notwithstanding the fact that the term, combination of terms, or services transferred between or among separate divisions, subsidiaries, or affiliates of a contractor; or

(8) A nondevelopmental item, if it is determined the item was developed exclusively at private expense and sold in substantial quantities, on a competitive basis, to multiple State and local governments or to multiple foreign governments..

"Commercially available off-the-shelf (COTS)" item—

(1) Means any item of supply (including construction material) that is

- () A commercial item (as defined in paragraph (1) of the definition in this section);
- () Sold in substantial quantities in the commercial marketplace; and
- () Offered to the Government, under a contract or subcontract at any tier, without modification, in the same form in which it is sold in the commercial marketplace; and

(2) Does not include bulk cargo, as defined in [46 U.S.C. 40102\(4\)](#), such as agricultural products and petroleum products.

CERTIFICATION

By submission of the foregoing certifications, I am attesting to the accuracy of the information contained in all sections herein. I understand that products and/or services offered are in support of the United States Government and I may be subject to penalties imposed by the United States Government if I misrepresent any of the representations or certifications herein. Under 15 U.S.C. 645(d), any person who misrepresents its size status shall (1) be punished by a fine, imprisonment or both; (2) be subject to administrative remedies; and (3) be ineligible for participation in programs conducted under the authority of the Small Business Act. Offeror further acknowledges that [redacted] shall rely on the information provided and any misrepresentation may result in Offeror's termination. If at any time during proposal submission and/or performance (through subcontract closeout), any representative of the Offeror's organization learns that the responses provided herein were erroneous when submitted or has become erroneous by reason of changed circumstances, Offeror is required to update its certifications immediately and submit to the [redacted] Cognizant Contractual representative of the order.

NAME OF PERSON AUTHORIZED TO BIND OFFEROR REGINALD B. BERKA	SIGNATURE OF PERSON AUTHORIZED TO BIND OFFEROR 
TITLE CHIEF OPERATING OFFICER	X
EMAIL ADDRESS RBERKA@HOUSTONMECHATRONICS.COM	DATE JULY 28, 2021
TELEPHONE NUMBER 281-942-9069	Date shall be not exceed 1 year prior to award.

ATTACHMENTS (Please check all applicable boxes)

Based on the responses to the foregoing certifications, the following are among the possible required attachments:

- | | |
|---|--|
| <input type="checkbox"/> Supplemental Parent Company Information | <input type="checkbox"/> Commercial Item Certification Support |
| <input checked="" type="checkbox"/> Accounting and/or System Approval Letters | <input type="checkbox"/> Certifications for the Delivery of Supplies |

CERTAIN IDENTIFIED INFORMATION HAS BEEN EXCLUDED FROM THIS EXHIBIT BECAUSE IT IS BOTH NOT MATERIAL AND IS THE TYPE THAT THE REGISTRANT TREATS AS PRIVATE OR CONFIDENTIAL.

COMPANY SHARED

Kongsberg Maritime AS

Deck Machinery and Motion Control Post office Box 1522

N-6025 ÅLESUND

NORWAY

Tel.: +4781520070, Fax: +47 70 20 86 00

www.kongsberg.com

Enterprise no: NO 980371379 MVA

**KONGSBERG****Commercial Offer**

160552_3

LARS for AQ 2.0

Nauticus Robotics



COMPANY SHARED

KONGSBERG Maritime AS

LARS for AQ 2.0

Table of contents

1.	DEFINITION	3
2.	SCOPE OF SUPPLY	3
3.	DELIVERY	3
4.	PRICE	4
5.	PAYMENT TERMS	4
6.	OPTIONS	5
7.	COMMISSIONING	5
8.	WARRANTY PERIOD	6

and quoted prices set out herein are indicative and may be amended. Kongsberg Maritime will make all reasonable commercial efforts to maintain the indicated delivery/performance dates and will keep the customer continuously informed to the best of its ability. Kongsberg Maritime do however not accept any liability for delay due to the current supply chain constraints. Kongsberg Maritime reserves the right to adjust the quoted prices if and to the extent that our calculations of the quoted prices would be directly impacted by the current supply chain constraints.

5. PAYMENT TERMS

LC: Irrevocable Letter of credit (LC) in a format and from a bank acceptable to KONGSBERG shall be opened at least ninety (90) days prior to the delivery time of the Equipment.

30% of the total contract value by telegraphic transfer upon contract effectiveness.

70% of the total contract price of the goods shipped shall be paid through the LC, upon submission of documents to be specified in the contract.

4

COMPANY SHARED

KONGSBERG Maritime AS

LARS for AQ 2.0

If the Purchaser fails to provide the Letter of Credit as set out above, this shall be deemed as breach of the payment obligations in accordance with Clause 21 of Orgalime S2012.

6. OPTIONS

To be offered upon request.

7. COMMISSIONING

Kongsberg Maritime provides, at no extra cost, commissioning services of the equipment included in the Scope of Supply.

All commissioning services provided by Kongsberg Maritime will be subject to "KM DMMC Commissioning TCs", attached as Appendix 3 hereto.

System	Commissioning and Harbour Acceptance Test	Sea trial
LARS 1	<ul style="list-style-type: none">- 2 Field Service Engineers for 5 days- Totally 10 man days (10 hours/day)- 1 trip <p>Waiting/Idle time is not included and will be invoiced.</p> <p>Living and lodging expenses for the period are included in the Price.</p>	Not included
LARS 2	<ul style="list-style-type: none">- 2 Field Service Engineers for 5 days- Totally 10 man days (10 hours/day)- 1 trip <p>Waiting/Idle time is not included and will be invoiced.</p> <p>Living and lodging expenses for the period are included in the Price.</p>	Not included

Above mentioned assistance is based on historical data and estimated to be sufficient under normal circumstances.

All Service Work not a part of Scope of Supply will be subject to Terms and Conditions as specified in separate agreed purchase order or variation order.

5

COMPANY SHARED

KONGSBERG Maritime AS

LARS for AQ 2.0

8. WARRANTY PERIOD

Orgalime s2012 clause 27 first sentence shall be amended to read as follows:

The warranty period shall commence upon delivery of the Equipment according to the agreed INCOTERM, or if customer fails to take delivery according to contract when risk passes if this occurs first, and shall expire 18 months thereafter or 12 months after the shipyard's delivery of the Vessel to the ship owner, whichever occurs first.

9. CLASS SURVEY

The Equipment will be designed and certified in accordance with the requirements of "DNVGL-ST-0378 - Standard for offshore and platform lifting appliances" applicable at the date of this quotation.

10. GENERAL TERMS

This quotation is subject to the terms and conditions stated in the Orgalime S2012 General conditions for the supply of mechanical, electrical and electronic products including KONGSBERG amendments thereto, as attached at Appendix 2.

CERTAIN IDENTIFIED INFORMATION HAS BEEN EXCLUDED FROM THIS EXHIBIT BECAUSE IT IS BOTH NOT MATERIAL AND IS THE TYPE THAT THE REGISTRANT TREATS AS PRIVATE OR CONFIDENTIAL.

COLLABORATION AGREEMENT

This COLLABORATION AGREEMENT (together with the Exhibits hereto, this “CA”), is made as of this 4th day of December 2020 (the “Effective Date”), by and between [REDACTED] a [REDACTED] and Houston Mechatronics, Inc., a Texas corporation (“HMI”). [REDACTED] and HMI are sometimes referred to herein as a “Party” or collectively as the “Parties.”

WITNESSETH:

WHEREAS, [REDACTED] is a leading information technology, engineering, and science solutions and services company that solves challenges in worldwide markets and develops technologies that improve mission performance of unmanned sea and underwater vehicles and make operating them safer and more efficient for customers worldwide;

WHEREAS, HMI develops an ecosystem of cloud-based subsea robots, software, and subsea services delivered in a modern business model to the offshore industry, including its flagship product Aquanaut; and

WHEREAS, [REDACTED] was the prime contractor for the [REDACTED]

[REDACTED] and HMI was a subcontractor to [REDACTED]

and

WHEREAS, HMI is already developing a variety of technologies, software, and other solutions under the [REDACTED], including but not limited to technologies, software, and solutions related to HMI’s Aquanaut and associated autonomous operation, machine learning and perception, robotic manipulation, maneuvering and propulsion, power and energy, and communication; and

WHEREAS, the Parties are pursuing an award of additional [REDACTED] contracts via [REDACTED] that may include upgraded software, subsystems, sensors, and technology developed and/or procured under the [REDACTED] (all phases of [REDACTED] collectively known herein as [REDACTED]);

WHEREAS, HMI desires to collaborate with [REDACTED] on designing and building a modified Aquanaut vehicle that is compatible with the software, subsystems, sensors and technologies being developed under the [REDACTED] so that [REDACTED] will have an operational modified Aquanaut on which the [REDACTED] and other components can be installed and demonstrated to and used with [REDACTED] Customers;

NOW THEREFORE, in consideration of the premises and mutual covenants contained in this CA and other good and valuable consideration, the receipt and sufficiency of which are hereby acknowledged, the Parties agree as follows:

ARTICLE I
DEFINITIONS

Section 1.01 Definitions. The following terms as used in this CA shall have the following meanings:

“Affiliate” means, as to any Person, any other Person directly or indirectly Controlling or Controlled by or under direct or indirect common Control with such specified Person. For purposes of this definition, “Control,” when used with respect to any specified Person, means the power to direct the management and policies of such Person, directly or indirectly, whether through the ownership of voting securities, by contract or otherwise, and the terms “Controlling” and “Controlled” have meanings correlative to the foregoing.

“Applicable Law” means, with respect to any Person, any domestic or foreign federal, state or local statute, law, ordinance, rule, administrative interpretation, regulation, order, writ, injunction, decree or other requirement of any Governmental Entity applicable to such Person or any of its properties, assets, officers, directors, employees, consultants or agents (in connection with such officer’s, director’s, employee’s, consultant’s or agent’s activities on behalf of such Person).

“Background Intellectual Property Rights” means all Intellectual Property Rights used, disclosed or delivered in performance of this CA that are: (a) developed, authored, invented, or controlled by either Party or its employee(s), consultant(s) or other agent(s) prior to, or on, the Effective Date of this CA; or (b) developed, authored, invented, or controlled by either Party or its employee(s), consultant(s) or other agent(s) after the Effective Date of this CA but not in performance of this CA. This definition includes Intellectual Property Rights acquired from another Person in performance of this CA. “Background Intellectual Property Rights” includes all Intellectual Property Rights either Party acquired under the [REDACTED]

“Business Day” means a day on which banks are open for business (other than a Saturday or Sunday) in the Commonwealth of Virginia.

“Confidential Information” means, as to any Person, any secret, confidential or proprietary information possessed by such Person, including trade secrets, Customer lists, details of client or consultant contracts, current and anticipated Customer requirements, pricing policies, price lists, market studies, business plans, operational methods, marketing plans or strategies, product development techniques or flaws, computer software (including object code, executable code and source code), data and documentation, base technologies, systems, structures and architectures, inventions and ideas, past current and planned research and development, compilations, devices, methods, techniques, processes, financial information and data, business acquisition plans, new personnel acquisition plans, future business plans, licensing strategies, and information regarding Customers, executives and independent contractors. The terms and conditions of this CA constitute Confidential Information of each Party.

“Customers” means all current, potential and future customers, teammates, prime contractors and subcontractors of [REDACTED] or HMI.

“Derivative Work” means any update, upgrade, revision, adaptation or enhancement made to a Party’s Background Intellectual Property Rights.

“Focus Domain” means the federal defense and intelligence community markets in the U.S and all foreign countries.

“Foreground Intellectual Property Rights” means all Intellectual Property Rights developed, authored or invented exclusively by a Party’s employee(s), consultant(s) or other agent(s) in performance of this CA. For the sake of clarity, all Intellectual Property Rights developed, authored, or invented by a Party’s employee(s), consultant(s), or other agents under the [REDACTED] are not Foreground Intellectual Property Rights.

[REDACTED] shall have the meaning given in the recitals.

[REDACTED] shall have the meaning given in the recitals.

[REDACTED] shall have the meaning given in the recitals.

“Governmental Entity” means any foreign, domestic, federal, territorial, state or local governmental authority, instrumentality, court or government, commission, tribunal or governmental organization, any international treaty organization, including the North Atlantic Treaty Organization, or any regulatory, administrative or other agency, or any political or other subdivision, department or branch of any of the foregoing.

“HMI Background Intellectual Property Rights” includes, but is not necessarily limited to, those Background Intellectual Property Rights described in Exhibit C.

“Integrated Systems” means all of the internal and external systems that provide the Modified Vehicle with its functional capabilities. The Integrated Systems are further described in **Exhibit A: (Technology Description)**.

“Intellectual Property Rights” or “IPR” means technical data, designs or solutions, drawings, diagrams, protocols, schematics, apparatuses, hardware, tools, products, devices, descriptions, methods, techniques, processes, formulae, specifications, procedures, methods and results, models, algorithms, software, software code (in any form including source code and object code or executable code), user interfaces, database rights, concepts, research, experimental work, prototypes, trade secrets, ideas, know-how, inventions, invention disclosures, patents, patent applications, copyrights, Confidential Information or proprietary information, mask works rights, registered and unregistered design rights, trademarks, service marks, trade names and any other forms of technology.

[REDACTED] Background Intellectual Property Rights” includes, but is not necessarily limited to, those Background Intellectual Property Rights described in Exhibit D.

“Modified Vehicle” means a new unmanned underwater vehicle based on HMI’s Aquanaut vehicle but repurposed for the defense and intelligence community [REDACTED] mission area. The Modified Vehicle is further described in **Exhibit A: (Technology Description)**, and will include HMI Background Intellectual Property Rights, [REDACTED] Background Intellectual Property Rights and Foreground Intellectual Property Rights.

“Person” means any individual, corporation, partnership, joint venture, trust, unincorporated organization or Governmental Entity.

“Project” means the research and development project being performed by the Parties under this CA to develop the Modified Vehicle and Integrated Systems.

“Roadmap Plan” means the product roadmap plan set forth as **Exhibit B (Product Roadmap Plan)**.

ARTICLE II OBJECTIVE AND DEVELOPMENT PLAN

Section 2.01 General. [REDACTED] and HMI will collaborate on the design, integration, and assembly of a Modified Vehicle and Integrated Systems, which may also include developing and/or implementing new hardware and software interfaces designed to receive, and be compatible with, the [REDACTED]. Both Parties agree to develop the Modified Vehicle with the Integrated Systems in accordance with the terms of, and based on the requirements set forth in this CA, the Technology Description and the Roadmap Plan, as may be amended in accordance with Section 2.04.

Section 2.02 Manner of Performance. [REDACTED] and HMI will develop the Roadmap Plan that will serve as a framework for aligning internal and contracted research and development and product development efforts with major product objectives and milestones of both Parties. Each Party shall perform its obligations hereunder in a professional manner, with reasonable skill, care and diligence and in a timely manner, in an effort to satisfy the time frames set forth in this CA and the Roadmap Plan. Each Party shall promptly notify the other upon becoming aware of any circumstances that could reasonably jeopardize such timely and successful performance. Without limiting the generality of the foregoing, each Party shall ensure that its obligations hereunder are performed by personnel possessing the professional skills, experience, qualifications and knowledge sufficient to perform their assigned tasks.

Section 2.03 Subcontracting. For the avoidance of doubt, each Party is solely responsible for the performance of its subcontractors, including to ensure that such subcontractors comply with the terms of this CA.

Section 2.04 Change Process. Each Party acknowledges that the scope of the Technology Description or Roadmap Plan may require modification from time to time to meet changing requirements, and each Party agrees to use the change order process set forth in this Section 2.04 for requesting and implementing any changes to the Technology Description or Roadmap Plan. The Parties agree to discuss in advance any proposed changes to the Technology or Roadmap Plan (including any changes to subcontractors identified therein) to determine its

desirability and its impact on the cost and schedule of the Roadmap Plan. The Parties agree to refrain from making any such change until it has been discussed and mutually approved in writing by both Parties. For any approved change to the Technology Description and/or Roadmap Plan, Exhibits A and/or B shall be deemed automatically modified to include the revised terms agreed in writing by both Parties without any further action required by the Parties.

ARTICLE III RELATIONSHIP MANAGEMENT

Section 3.01 Status Review Meetings. During the Term of this CA, the Parties shall hold monthly status meetings, as further set forth in the Roadmap Plan, to monitor, review and discuss the progress of the Roadmap Plan and determine whether the Modified Vehicle with the Integrated Systems is viable as a Customer offering and has commercial value. The Parties will also consider potential opportunities in the Focus Domain in which Customer requirements may intersect with the objectives of the CA. Each Party shall bear its own expenses for its representatives attending and participating in such meetings.

Section 3.02 Marketing. [REDACTED] will use commercially reasonable efforts at its own expense to promote the sale and distribution of the Modified Vehicle with the Integrated Systems in the Focus Domain including undertaking promotional campaigns and canvassing prospective Customers to stimulate the sales of Modified Vehicle with the Integrated Systems. HMI will provide [REDACTED] with such marketing and technical assistance at no cost as [REDACTED] may in its reasonable discretion consider necessary to assist with the promotion and sale of the Modified Vehicle with the Integrated Systems. During performance of the CA and Roadmap Plan, but only if the Parties mutually agree that a viable offering exists to sell to Customers, the Parties may further negotiate in good faith: (i) a joint marketing plan to address activities related to marketing, manufacturing, support, distribution and sale of the Modified Vehicle with the Integrated Systems, including pursuing contracts with Customers; and/or (ii) the terms and conditions of a supply agreement identifying the entity that shall manufacture or have manufactured and supply the Modified Vehicle and the Integrated Systems.

Section 3.03 Teaming Agreements. If a prospective Customer in the Focus Domain issues a request for proposal or other indication of interest with respect to the procurement of the Modified Vehicle and Integrated Systems or substantially similar offering, including any supporting or derivative technology (i.e. charging stations, related development contracts, etc.), [REDACTED] and HMI will negotiate in good faith to agree upon a mutually acceptable teaming arrangement or joint venture for the purpose of submitting a proposal in response thereto. Unless otherwise agreed, each Party would bear its own bid and proposal costs.

Section 3.04 Relationship and Responsibilities of the Parties.

(a) HMI shall have no authority to assume, incur or create any liability or obligation on behalf of [REDACTED] or to bind [REDACTED] in any respect. HMI shall act at all times as an independent entity, and not as a partner, joint venturer, agent or employee of [REDACTED]. HMI and its agents and employees shall not be entitled to any benefits, privileges or compensation given or extended by [REDACTED] to [REDACTED] employees. All agents and

employees of HMI shall be deemed to be HMI's agents and employees exclusively, and the entire management, direction, and control thereof shall be vested exclusively in HMI.

(b) [REDACTED] shall have no authority to assume, incur or create any liability or obligation on behalf of HMI or to bind HMI in any respect. [REDACTED] shall act at all times as an independent entity, and not as a partner, joint venturer, agent or employee of HMI. [REDACTED] and its agents and employees shall not be entitled to any benefits, privileges or compensation given or extended by HMI to HMI's employees. All agents and employees of [REDACTED] shall be deemed to be [REDACTED] agents and employees exclusively, and the entire management, direction, and control thereof shall be vested exclusively in [REDACTED]

(c) [REDACTED] and HMI may also pursue their respective business interests in the Focus Domain in areas outside the scope of this CA that do not compete or conflict with or negatively impact the exclusivity provisions of this CA. The Parties acknowledge and agree that performance under any contract with a Governmental Entity, including the [REDACTED], and any subsequent follow on contracts, modifications, or revisions, is permitted.

(d) In exchange for [REDACTED] ownership rights in the Modified Vehicle and Integrated Systems (but excluding ownership of HMI Background Intellectual Property Rights and the HMI Foreground Intellectual Property Rights therein), and the Intellectual Property Rights granted by HMI below, [REDACTED] will:

(i) Pay all costs and expenses, including internal research and development costs, incurred by [REDACTED] and HMI associated with the development of the Foreground Intellectual Property Rights for the Modified Vehicle and Integrated Systems and developing and/or implementing new hardware and software interfaces designed to receive, and be compatible with, any required HMI Background Intellectual Property Rights and [REDACTED] Background Intellectual Property Rights ("Development Costs"). The Parties estimate that the Development Costs will be approximately [REDACTED]. [REDACTED] would fund the Development Costs in advance by paying to HMI [REDACTED] in December 2020.

(ii) Pay all costs and expenses as incurred by [REDACTED] and HMI associated with the manufacture of a single Modified Vehicle and Integrated Systems ("Manufacturing Costs") up to an amount equal to [REDACTED] less the actual amount of the Development Costs. The Parties estimate that Manufacturing Costs will be approximately [REDACTED]. No Manufacturing Costs will be incurred unless and until Leidos is awarded the Phase II contract of the [REDACTED].

To the extent that the aggregate amount of Development Costs and Manufacturing Costs exceed [REDACTED] (for one Modified Vehicle with the Integrated Systems), such excess costs, not to exceed [REDACTED], will be borne by HMI. If the cumulative total of the Development Costs and Manufacturing Costs (including those funded by HMI directly) reach [REDACTED] of the [REDACTED]

██████████ the Parties shall meet and confer in good faith to address any expected remaining costs to be incurred and how to handle any expenses (if any) if the Project costs exceed ██████████

(e) ██████████ shall not sell, lease, or otherwise commercialize any Modified Vehicle with the Integrated Systems to Customers unless and until ██████████ and HMI have agreed to a reasonable royalty to be paid by ██████████ to HMI for a license to use the HMI Background Intellectual Property Rights and HMI Foreground Intellectual Property Rights, or a similar arrangement is formed between the Parties. ██████████s and HMI will negotiate in good faith the terms and conditions of a mutually acceptable royalty agreement.

(f) Any agreement between the Parties as described in Section 3.04(e) shall include the terms and conditions under which HMI will (i) provide ██████████ Customers with technical support and maintenance on the Modified Vehicle with the Integrated Systems; and (ii) designate maintenance and support personnel to train ██████████ support personnel in providing maintenance and support services to Customers of the Modified Vehicle with the Integrated Systems.

(g) HMI shall negotiate and sign a reasonable third party escrow agreement (“Escrow Agreement”) with ██████████ within (45) forty-five days of the effective date of the CA, or as otherwise determined mutually by the Parties, with the escrow agent exclusively chosen by ██████████. Unless specifically provided otherwise in the Escrow Agreement, ██████████ will pay the costs for escrow and HMI shall deposit into the escrow account within (30) thirty days of the effective date of the Escrow Agreement the technical designs and computer software source code required for ██████████ or a third party to support and maintain or make or have made the Modified Vehicle with the Integrated Systems. HMI shall update the deposit with the escrow agent each time updates or upgrades become available. The deposit shall be released to ██████████ in the event that HMI ceases to operate as an ongoing concern, or any other release condition negotiated in the escrow agreement. ██████████ rights to utilize the materials released from escrow shall be limited to those necessary to exercise the rights granted to ██████████ hereunder.

ARTICLE IV
INTELLECTUAL PROPERTY RIGHTS OWNERSHIP AND LICENSES

Section 4.01 Intellectual Property Rights Ownership.

(a) Background Intellectual Property Rights. The Parties acknowledge and agree that HMI shall continue to own all right, title and interest (including without limitation all Intellectual Property Rights) in and to HMI’s Background Intellectual Property Rights, and ██████████ shall continue to own all right, title and interest (including without limitation all Intellectual Property Rights) in and to ██████████ Background Intellectual Property Rights.

(b) Ownership of Foreground Intellectual Property Rights. The Parties acknowledge and agree that [REDACTED] shall own all right, title and interest (including without limitation all Intellectual Property Rights) in and to all Foreground Intellectual Property Rights developed in performance of this CA through the Development Costs and Manufacturing Costs [REDACTED]. HMI hereby assigns, conveys and transfers to [REDACTED] without any further consideration all right, title and interest it has in the [REDACTED], and upon request shall execute any required papers and furnish all reasonable assistance to [REDACTED] to vest all right, title and interest in such [REDACTED] in [REDACTED]. Any Foreground Intellectual Property Rights developed in performance of this CA and funded by HMI shall be owned by HMI, but only to the extent that HMI pays any Development and Manufacturing Costs under this CA in addition to the [REDACTED] (or other amount) in Development and Manufacturing Costs funded by [REDACTED].

(d) Derivative Works. The Parties acknowledge and agree that HMI shall own all right, title and interest (including without limitation all Intellectual Property Rights) in and to Derivative Works in HMI Background Intellectual Property Rights, and Leidos shall own all right, title and interest (including without limitation Intellectual Property Rights) in and to Derivative Works in [REDACTED] Background Intellectual Property Rights.

Section 4.02 [REDACTED] Exclusive Licensing Rights. Subject to full payment by [REDACTED] to HMI under Section 3.04(d), and upon HMI and [REDACTED] finalizing the royalty agreement under Section 3.04(e), HMI grants to [REDACTED] and its Affiliates an exclusive, paid-up (but subject to the future royalties for future commercialization), perpetual, worldwide license to use, reproduce, modify and distribute (including the specifications for the Integrated Systems), make, have made, import, sell and offer for sale HMI's Background IPR, HMI's Foreground IPR and HMI's Derivative Works as delivered in the Modified Vehicle and Integrated Systems to perform the CA and the Project, to operate and demonstrate the Modified Vehicle and Integrated Systems with Customers, to satisfy any contractual requirement under the [REDACTED] and with all other Customers under any additional contract in the Focus Domain to which [REDACTED] is a party. HMI shall not grant any of the foregoing Intellectual Property Rights to another Person for use in the Focus Domain without [REDACTED] prior written consent. The exclusivity provisions, and the restrictions on HMI not granting Intellectual Property Rights to another Person do not apply to HMI's performance of contracts as a teammate of [REDACTED] with Government Entities (for example, HMI's performance of contracts under the [REDACTED] as a subcontractor to [REDACTED]). HMI also retains its rights to commercialize its Background IPR in all domains as manifested in the HMI Aquanaut.

Section 4.03 Exception. [REDACTED] exclusive licensing rights in Section 4.02 will automatically and immediately vest in [REDACTED] in the event that HMI ceases to operate as a business or files for bankruptcy and can no longer perform its obligations under this CA prior to [REDACTED] satisfying the requirements of Section 3.04(d) and (e).

Section 4.04 HMI's Licensing Rights. HMI shall use [REDACTED] Intellectual Property rights under this CA only to develop and manufacture the Modified Vehicle and Integrated

Systems and for no other purpose. HMI shall obtain [REDACTED] prior written consent before using [REDACTED] Intellectual Property Rights under this CA for any other purpose.

**ARTICLE V
REPRESENTATIONS AND WARRANTIES**

Section 5.01 Representations and Warranties of [REDACTED]. [REDACTED] represents, warrants and covenants that [REDACTED] has all requisite corporate power and authority to execute, deliver and perform this CA.

Section 5.02 Representations and Warranties of HMI. HMI represents, warrants and covenants that:

(a) HMI has all requisite corporate power and authority to execute, deliver and perform this CA; and

(b) HMI owns or controls all intellectual property rights in the Aquanaut Vehicle, including the Background Intellectual Property Rights, necessary to grant the licenses and rights to [REDACTED] herein.

Section 5.03 Warranty Disclaimer. THE EXPRESS WARRANTIES SET FORTH IN THIS CA ARE IN LIEU OF ALL OTHER WARRANTIES, IMPLIED OR STATUTORY, INCLUDING BUT NOT LIMITED TO ANY: (A) IMPLIED WARRANTY OF MERCHANTABILITY OR FITNESS FOR A PARTICULAR PURPOSE, OR (B) IMPLIED WARRANTY ARISING FROM COURSE OF PERFORMANCE, COURSE OF DEALING OR USAGE OR TRADE. NEITHER PARTY AUTHORIZES THE OTHER PARTY OR ANY THIRD PARTY TO MAKE ANY REPRESENTATIONS OR WARRANTY OF ANY KIND ON ITS BEHALF WITHOUT ITS EXPRESS WRITTEN CONSENT, AND NEITHER PARTY SHOULD RELY ON ANYONE MAKING SUCH STATEMENTS.

Section 5.04 Limitations of Liability. EXCEPT FOR THE INFRINGEMENT INDEMNIFICATION OBLIGATIONS SET FORTH IN ARTICLE VIII HEREOF OR MISAPPROPRIATION OR MISUSE OF THE OTHER PARTY'S INTELLECTUAL PROPERTY OR CONFIDENTIAL INFORMATION, THE TOTAL LIABILITY OF EITHER PARTY AND ITS AFFILIATES, INCLUDING THEIR SUBCONTRACTORS OR SUPPLIERS, ON ANY CLAIM, WHETHER IN CONTRACT, WARRANTY, TORT (INCLUDING GROSS NEGLIGENCE) OR OTHERWISE, ARISING OUT OF, CONNECTED WITH, OR RESULTING FROM THE PERFORMANCE OR NONPERFORMANCE OF THIS AGREEMENT OR ANY AGREEMENT RESULTING FROM THIS AGREEMENT OR FROM THE MANUFACTURE, SALE, DELIVERY, RESALE, REPAIR, REPLACEMENT OR USE OF THE MODIFIED VEHICLE WITH THE INTEGRATED SYSTEMS, ANY PRODUCT OR THE FURNISHING OF ANY SERVICE, SHALL NOT EXCEED [REDACTED] [REDACTED] OR THE PRICE ALLOCABLE TO THE PRODUCT OR SERVICE WHICH GIVES RISE TO THE CLAIM, WHICHEVER IS LESS. NEITHER PARTY SHALL BE LIABLE, WHETHER IN CONTRACT, TORT (INCLUDING NEGLIGENCE) OR OTHERWISE, FOR ANY SPECIAL, INDIRECT, INCIDENTAL,

CONSEQUENTIAL OR EXEMPLARY DAMAGES (EVEN IF NOTIFIED IN ADVANCE OF SUCH POSSIBILITY) ARISING OUT OF OR PERTAINING TO THE SUBJECT MATTER OF THIS CA. EACH PARTY ACKNOWLEDGES THAT THIS SECTION 5.04 REFLECTS AN INFORMED, VOLUNTARY ALLOCATION BETWEEN THE PARTIES OF THE RISKS (KNOWN AND UNKNOWN) THAT MAY EXIST IN CONNECTION WITH THIS CA.

Section 5.5 Waiver of Jury Trial. EACH PARTY HEREBY WAIVES ITS RIGHTS TO A JURY TRIAL OF ANY CLAIM OR CAUSE OF ACTION BASED UPON OR ARISING OUT OF THIS CA OR THE SUBJECT MATTER HEREOF. THE SCOPE OF THIS WAIVER IS INTENDED TO BE ALL-ENCOMPASSING OF ANY AND ALL DISPUTES THAT MAY BE FILED IN ANY COURT AND THAT RELATE TO THE SUBJECT MATTER OF THIS CA, INCLUDING, WITHOUT LIMITATION, CONTRACT CLAIMS, TORT CLAIMS (INCLUDING NEGLIGENCE), BREACH OF DUTY CLAIMS, AND ALL OTHER COMMON LAW AND STATUTORY CLAIMS. THIS SECTION HAS BEEN FULLY DISCUSSED BY EACH OF THE PARTIES HERETO AND THESE PROVISIONS WILL NOT BE SUBJECT TO ANY EXCEPTIONS. EACH PARTY HERETO HEREBY FURTHER WARRANTS AND REPRESENTS THAT SUCH PARTY HAS REVIEWED THIS WAIVER WITH ITS LEGAL COUNSEL, AND THAT SUCH PARTY KNOWINGLY AND VOLUNTARILY WAIVES ITS JURY TRIAL RIGHTS FOLLOWING CONSULTATION WITH LEGAL COUNSEL.

ARTICLE VI CONFIDENTIALITY

Section 6.01 General Obligations. Neither Party will disclose the Term Sheet or CA to any person other than their respective officers, directors, attorneys and accountants. In addition, this Term Sheet, CA and all confidential and proprietary information disclosed by the Parties shall be subject to the terms of the certain Non-Disclosure Agreement dated November 2, 2018 between the Parties, which shall remain in full force and effect in accordance with its terms.

Section 6.02 Disclosure to Governmental Entities. Notwithstanding any provision of this Article VI to the contrary, either Party may disclose to any Governmental Entity any Intellectual Property Rights or any physical embodiments or evidence thereof, or any Confidential Information of either Party, to the extent such disclosure is necessary or appropriate, in a Party's reasonable judgment, in connection with such Party's performance of the CA or an evaluation or demonstration of the Modified Vehicle with the Integrated Systems; provided, however, that the disclosing Party shall be required to designate any such Confidential Information disclosed pursuant to this Section 6.02 as "proprietary" or with other appropriate governmental legends.

Section 6.03 Disclosure for Intellectual Property Filings. Either Party may also disclose any of its own Intellectual Property Rights to the intellectual property office of Governmental Entities necessary or appropriate to seek intellectual property protection for such Intellectual Property Rights.

**ARTICLE VII
TERM AND TERMINATION**

Section 7.01 Term. The term of this CA (the "Term") shall commence upon the Effective Date and shall remain in effect for two (2) years thereafter unless terminated pursuant to Section 7.02 or 7.03.

Section 7.02 Termination by [REDACTED]. This CA and the licensed rights granted hereunder may be terminated by [REDACTED]

(a) effective upon thirty (30) days prior written notice to HMI that neither [REDACTED] nor any Affiliate or sublicensee of [REDACTED] is exercising any of the rights granted in this CA or that meeting the objectives of this CA is no longer possible or practicable;

(b) if HMI is in material breach or default of any term or provision of this CA, [REDACTED] may give written notice to HMI specifying the nature and extent of the default, and HMI shall have thirty (30) days thereafter to cure the default. If the default is not cured to [REDACTED] reasonable satisfaction within the 30-day period, [REDACTED] may, by written notice, declare this CA terminated; or

(c) if [REDACTED] is not awarded the Phase II contract of the [REDACTED]

Section 7.03 Termination by HMI. This CA and the licensed rights granted hereunder may be terminated by HMI:

(a) if [REDACTED] is in material breach or default of any term or provision of this CA, HMI may give written notice to [REDACTED] specifying the nature and extent of the default, and [REDACTED] shall have thirty (30) days thereafter to cure the default. If the default is not cured to HMI's reasonable satisfaction within the 30-day period, HMI may, by written notice, declare this CA terminated; or

(b) if [REDACTED] is not awarded the Phase II contract of the [REDACTED]

Section 7.04 Effect of Termination. In the event of the termination of this CA, this CA shall forthwith be terminated and have no further force or effect, except (a) that the following provisions shall survive: Article IV (Intellectual Property Rights Ownership and Licenses), Section 5.04 (Limitation of Liability), Article VI (Confidentiality), Section 7.04 (Effect of Termination), Article VIII (Indemnification) and Article IX (Miscellaneous), and (b) that any and all claims arising prior to such termination shall survive such termination.

**ARTICLE VIII
INFRINGEMENT INDEMNIFICATION**

Section 8.01 HMI Infringement Indemnification. HMI will defend, indemnify, and hold harmless [REDACTED], its officers, directors, employees, consultants, agents, Affiliates, successors, permitted assigns and Customers from and against all losses, costs, claims, causes of action, damages, liabilities, and expenses, including reasonable attorney's fees, all expenses of litigation and/or settlement, and court costs, arising out of any action by a third party that is based upon a claim that HMI's Background IPR and Derivative Works under the CA infringe or otherwise violate U.S. based Intellectual Property Rights of any Person.

Section 8.02 [REDACTED] Infringement Indemnification. [REDACTED] will defend, indemnify, and hold harmless HMI, its officers, directors, employees, consultants, agents, Affiliates, successors, permitted assigns and Customers from and against all losses, costs, claims, causes of action, damages, liabilities, and expenses, including reasonable attorney's fees, all expenses of litigation and/or settlement, and court costs, arising out of any action by a third party that is based upon a claim that [REDACTED] Background IPR and Derivative Works under the CA infringe or otherwise violate U.S. based Intellectual Property Rights of any Person.

Section 8.03 Procedures. If either Party (as the "Licensor") believes that its IPR are or will become the subject of an infringement claim, or in the event that use of the Licensor's IPR is enjoined, the Licensor, at its own expense and discretion, may either: (a) obtain the right for the other Party (as the "Licensee") to continue using the IPR; or (b) modify the IPR to make them non-infringing while maintaining substantially similar functionality or content; or (c) replace the IPR with similar items that have substantially similar functionality or content. If none of such alternatives is commercially practicable determined exclusively by the Licensor, the infringing item shall be returned to the Licensor and the Licensor shall refund any royalties paid by the Licensee to the Licensor for using the Licensor's IPR.

Section 8.04 Exceptions. The Licensor shall have no obligation hereunder to defend, indemnify or hold harmless Licensee or to pay any damage, loss, liability, cost, or expense, including reasonable attorneys' fees, with respect to any claim, action or demand arising from: (i) combining the Licensor's item with other items, however acquired, not supplied by Licensor; (ii) alteration of the Licensor's item by anyone or any entity other than Licensor; (iii) continued infringing activity by Licensee after it has been notified of the infringement; (iv) failure of Licensee to use updated or modified items provided by Licensor; or (v) items developed by Licensor in accordance with written specifications or designs from Licensee or its Customer.

ARTICLE IX MISCELLANEOUS

Section 9.01 Notices. All notices and other communications given or made pursuant to this CA shall be in writing and shall be deemed effectively given upon the earlier of actual receipt or: (a) personal delivery to the Party to be notified, (b) when sent, if sent by electronic mail during normal business hours of the recipient, and if not sent during normal business hours, then on the recipient's next Business Day, (c) five (5) days after having been sent by registered or certified mail, return receipt requested, postage prepaid, or (d) one (1) Business Day after deposit with a nationally recognized overnight courier, freight prepaid, specifying next Business Day delivery, with written verification of receipt. All communications shall be sent to the respective Parties at

their address as set forth on the signature page, or to such email address or address as subsequently modified by written notice given in accordance with this Subsection 9.01.

Section 9.02 Exhibits. Any Exhibits to this CA are hereby incorporated into this CA as if set out in full in this CA.

Section 9.03 Assignment; Successors in Interest.

(a) HMI shall not assign or transfer any of its rights or obligations under this CA without the prior written consent of Leidos; provided that subject to Section 9.03(b), HMI shall be entitled to assign this CA in connection with the sale of all or substantially all of the assets of HMI; provided that any assignee agrees in a writing delivered to [REDACTED] to comply with the terms and conditions of this CA. [REDACTED] shall not assign or transfer any of its rights or obligations under this CA without the prior written consent of HMI; provided that subject to Section 9.03(b), [REDACTED] shall be entitled to assign this CA in connection with the sale of all or substantially all of the assets of [REDACTED] or with the sale of all or substantially all of the assets of the [REDACTED] business group performing this CA, the [REDACTED], and [REDACTED]; provided that any assignee agrees in a writing delivered to HMI to comply with the terms and conditions of this CA. Any assignment or transfer by either Party in violation of this Section 9.03 shall be void.

(b) The terms and conditions of this CA shall inure to the benefit of and be binding upon the respective permitted successors and assigns of the Parties.

Section 9.04 Construction. As used in this CA, any reference to the masculine, feminine or neuter gender shall include all genders, the plural shall include the singular, and singular shall include the plural. Unless the context otherwise requires, the term "Party" when used in this CA means a party to this CA. The words "include," "includes" and "including" when used herein shall be deemed to be followed by the phrase "without limitation" unless such phrase otherwise appears. Unless the context otherwise requires, references in this CA to Articles, Sections, Exhibits and Schedules shall be deemed references to Articles and Sections of, and Exhibits and Schedules to, this CA. Unless the context otherwise requires, the words "hereof," "hereby" and "herein" and words of similar meaning when used in this CA refer to this CA in its entirety and not to any particular Article, Section or provision hereof. Except when used together with the word "either" or otherwise for the purpose of identifying mutually exclusive alternatives, the term "or" has the inclusive meaning represented by the phrase "and/or". Any deadline or time period set forth in this CA that by its terms ends on a day that is not a Business Day shall be automatically extended to the next succeeding Business Day. With regard to each and every term and condition of this CA, the Parties understand and agree that the same have or has been mutually negotiated, prepared and drafted, and that if at any time the Parties desire or are required to interpret or construe any such term or condition or any agreement or instrument subject thereto, no consideration shall be given to the issue of which Party actually prepared, drafted or requested any term or condition of this CA.

Section 9.05 Titles and Subtitles. The titles and subtitles used in this CA are for convenience only and are not to be considered in construing or interpreting this CA.

Section 9.06 Governing Law. This CA shall be governed by the laws of the State of Delaware, without regards to its conflict of laws provisions.

Section 9.07 Dispute Resolution. It is the intent of the Parties that all disputes arising under this CA be resolved expeditiously, amicably, and at the level within each Party's organization that is most knowledgeable about the disputed issue. The Parties understand and agree that the procedures outlined in this Section are not intended to supplant the routine handling of inquiries and complaints through informal contact of the Parties. Accordingly, for purposes of the procedure set forth herein, a "dispute" is a disagreement that the Parties have been unable to resolve by the normal and routine channels ordinarily used for such matters, or a perceived default or breach by a Party. Before either Party seeks any remedies available at law, the Parties shall sequentially follow the procedures set forth below:

- (a) The complaining Party's representative will notify the other Party's representative in writing of the dispute, and the other Party will exercise good faith efforts to resolve the matter as expeditiously as possible;
- (b) If the dispute remains unresolved thirty (30) days after the delivery of the complaining Party's written notice, a senior representative of each Party shall meet or participate in a telephone conference call within ten (10) business days of a request for the meeting or conference call by either Party to resolve the dispute; and
- (c) If the Parties are unable to reach a resolution of the dispute after following these procedures, or if either Party fails to participate when requested, then the Parties may pursue any remedies available at law or in equity.

Each Party will bear its own costs in respect of any disputes arising under this CA. The substantially prevailing party shall be entitled to reasonable attorney's fees, costs, and necessary disbursements in addition to any other relief to which such party may be entitled.

Section 9.08 Compliance with Laws. In performing its obligations hereunder and any services and activities undertaken in connection therewith, each Party shall comply with all Applicable Law.

Section 9.09 Use of Name; Publicity. Neither Party shall issue any press release or public announcement or make any public disclosure (including promotional or marketing material) regarding the existence or terms and conditions of this CA without the prior written consent of the other Party; provided, however, that the foregoing will not prohibit any disclosure to the extent required by Applicable Law or the rules of any stock exchange where a Party's securities are traded.

Section 9.10 Expenses. Except as expressly set forth in this CA, each Party assumes full responsibility for all costs and expenses incurred in carrying out its obligations under this CA.

Section 9.11 Severability. The invalidity or unenforceability of any provision hereof shall in no way affect the validity or enforceability of any other provision.

Section 9.12 Counterparts. This CA may be executed in two or more counterparts, each of which shall be deemed an original, but all of which together shall constitute one and the same instrument. Counterparts may be delivered via facsimile, electronic mail (including pdf) or other transmission method and any counterpart so delivered shall be deemed to have been duly and validly delivered and be valid and effective for all purposes.

Section 9.13 Third Party Beneficiaries. Nothing expressed or implied in this CA is intended, or shall be construed, to confer upon or give any Person (including any client, Customer, sublicense, employee, partner or other representative of the Parties) other than the Parties, the indemnified parties (under Sections 8.01 and 8.02) and their successors or permitted assigns, any rights, remedies, obligations or liabilities under or by reason of this CA, or result in such Person being deemed a third party beneficiary of this CA. All provisions hereof shall be personal solely among the Parties to this CA.

Section 9.14 Entire Agreement. This CA (including the Exhibits hereto) constitutes the full and entire understanding and agreement between the Parties with respect to the subject matter hereof, and any other written or oral agreement relating to the subject matter hereof existing between the Parties are expressly canceled.

Section 9.15 Amendments; Waivers; Force Majeure.

(a) Any provision of this CA may be amended or waived if, and only if, such amendment or waiver is in writing and signed (i) in the case of an amendment, by each Party, and (ii) in the case of a waiver, by the Party against whom the waiver is to be effective.

(b) No delay or omission to exercise any right, power or remedy accruing to any Party under this CA, upon any breach or default of any other party under this CA, shall impair any such right, power or remedy of such non-breaching or non-defaulting Party nor shall it be construed to be a waiver of any such breach or default, or an acquiescence therein, or of or in any similar breach or default thereafter occurring; nor shall any waiver of any single breach or default be deemed a waiver of any other breach or default theretofore or thereafter occurring. Any waiver, permit, consent or approval of any kind or character on the part of any Party of any breach or default under this CA, or any waiver on the part of any Party of any provisions or conditions of this CA, must be in writing and shall be effective only to the extent specifically set forth in such writing. All remedies, either under this CA or by law or otherwise afforded to any Party, shall be cumulative and not alternative.

(c) The Parties understand and agree that in the event of an act of the government, or war conditions, or fire, flood, tornados, hurricanes, earthquakes or labor strike, pandemics (including COVID-19) and epidemics or acts of God that prevents the performance by either Party of the provisions of this CA, then such non-performance by that Party shall not be considered as grounds for breach of this CA and such non-performance shall be excluded while the conditions herein prevail and for (6) six months thereafter.

[remainder of this page intentionally left blank; signature page follows]

IN WITNESS WHEREOF, the Parties have caused this CA to be duly executed, as of the Effective Date above.

[REDACTED]

By: [REDACTED]

Name: [REDACTED]

Title: [REDACTED]

[REDACTED]

HOUSTON MECHATRONICS, INC.

By: [REDACTED]

Name: Nicolaus A. Radford

Title: President, CEO

HMI address for notices:

Houston Mechatronics, Inc.
17146 Feathercraft Lane, Suite 450,
Webster, TX 77598,
Attention: Nicolaus A. Radford

[REDACTED]

CONSENT OF INDEPENDENT REGISTERED PUBLIC ACCOUNTING FIRM

We hereby consent to the use in the Prospectus constituting a part of this Registration Statement on Amendment No. 4 to Form S-4 of our report dated March 29, 2022, relating to the consolidated financial statements CleanTech Acquisition Corp., which is contained in that Prospectus. We also consent the reference to our Firm under the caption “Experts” in the Prospectus.

/s/ WithumSmith+Brown, PC

New York, New York
June 16, 2022

CONSENT OF INDEPENDENT REGISTERED PUBLIC ACCOUNTING FIRM

We consent to the inclusion in this Registration Statement on Amendment No. 4 to Form S-4 and related proxy statement/prospectus of CleanTech Acquisition Corp. of our report dated March 24, 2022, except for Note 13, as to which the date is April 27, 2022, with respect to the financial statements of Nauticus Robotics, Inc. which appears in this Registration Statement. We also consent to the reference to our firm under the heading “Experts” in the proxy statement/prospectus which is part of this Registration Statement.

/s/ Whitley Penn LLP

Houston, Texas
June 16, 2022

Consent to be Named as a Director Nominee

In connection with the filing by CleanTech Acquisition Corp. (the "Registrant") of the Registration Statement on Form S-4 with the Securities and Exchange Commission under the Securities Act of 1933, as amended (the "Securities Act"), I hereby consent, pursuant to Rule 438 under the Securities Act, to being named in the Registration Statement and any and all amendments and supplements thereto as a member of the board of directors of the Registrant following the consummation of the business combination involving Nauticus Robotics, Inc. and the Registrant. I also consent to the filing of this consent as an exhibit to such Registration Statement and any amendments thereto.

Dated: June 16, 2022

/s/ Nicolaus Radford

Nicolaus Radford

Consent to be Named as a Director Nominee

In connection with the filing by CleanTech Acquisition Corp. (the "Registrant") of the Registration Statement on Form S-4 with the Securities and Exchange Commission under the Securities Act of 1933, as amended (the "Securities Act"), I hereby consent, pursuant to Rule 438 under the Securities Act, to being named in the Registration Statement and any and all amendments and supplements thereto as a member of the board of directors of the Registrant following the consummation of the business combination involving Nauticus Robotics, Inc. and the Registrant. I also consent to the filing of this consent as an exhibit to such Registration Statement and any amendments thereto.

Dated: June 16, 2022

/s/ Mark Mey

Mark Mey

Consent to be Named as a Director Nominee

In connection with the filing by CleanTech Acquisition Corp. (the “Registrant”) of the Registration Statement on Form S-4 with the Securities and Exchange Commission under the Securities Act of 1933, as amended (the “Securities Act”), I hereby consent, pursuant to Rule 438 under the Securities Act, to being named in the Registration Statement and any and all amendments and supplements thereto as a member of the board of directors of the Registrant following the consummation of the business combination involving Nauticus Robotics, Inc. and the Registrant. I also consent to the filing of this consent as an exhibit to such Registration Statement and any amendments thereto.

Dated: June 16, 2022

/s/ Lisa Porter
Lisa Porter

Consent to be Named as a Director Nominee

In connection with the filing by CleanTech Acquisition Corp. (the "Registrant") of the Registration Statement on Form S-4 with the Securities and Exchange Commission under the Securities Act of 1933, as amended (the "Securities Act"), I hereby consent, pursuant to Rule 438 under the Securities Act, to being named in the Registration Statement and any and all amendments and supplements thereto as a member of the board of directors of the Registrant following the consummation of the business combination involving Nauticus Robotics, Inc. and the Registrant. I also consent to the filing of this consent as an exhibit to such Registration Statement and any amendments thereto.

Dated: June 16, 2022

/s/ Adam Sharkawy

Adam Sharkawy

Consent to be Named as a Director Nominee

In connection with the filing by CleanTech Acquisition Corp. (the "Registrant") of the Registration Statement on Form S-4 with the Securities and Exchange Commission under the Securities Act of 1933, as amended (the "Securities Act"), I hereby consent, pursuant to Rule 438 under the Securities Act, to being named in the Registration Statement and any and all amendments and supplements thereto as a member of the board of directors of the Registrant following the consummation of the business combination involving Nauticus Robotics, Inc. and the Registrant. I also consent to the filing of this consent as an exhibit to such Registration Statement and any amendments thereto.

Dated: June 16, 2022

/s/ John W. Gibson, Jr.

John W. Gibson, Jr.

Consent to be Named as a Director Nominee

In connection with the filing by CleanTech Acquisition Corp. (the "Registrant") of the Registration Statement on Form S-4 with the Securities and Exchange Commission under the Securities Act of 1933, as amended (the "Securities Act"), I hereby consent, pursuant to Rule 438 under the Securities Act, to being named in the Registration Statement and any and all amendments and supplements thereto as a member of the board of directors of the Registrant following the consummation of the business combination involving Nauticus Robotics, Inc. and the Registrant. I also consent to the filing of this consent as an exhibit to such Registration Statement and any amendments thereto.

Dated: June 16, 2022

/s/ Eli Spiro

Eli Spiro

Consent to be Named as a Director Nominee

In connection with the filing by CleanTech Acquisition Corp. (the "Registrant") of the Registration Statement on Form S-4 with the Securities and Exchange Commission under the Securities Act of 1933, as amended (the "Securities Act"), I hereby consent, pursuant to Rule 438 under the Securities Act, to being named in the Registration Statement and any and all amendments and supplements thereto as a member of the board of directors of the Registrant following the consummation of the business combination involving Nauticus Robotics, Inc. and the Registrant. I also consent to the filing of this consent as an exhibit to such Registration Statement and any amendments thereto.

Dated: June 16, 2022

/s/ Joseph W. Dyer

Joseph W. Dyer

PRELIMINARY COPIES

PROXY CARD
 CleanTech Acquisition Corp.
 207 West 25th Floor, 9th Floor
 New York, NY 10001

SPECIAL MEETING OF STOCKHOLDERS

THIS PROXY IS SOLICITED ON BEHALF OF THE BOARD OF DIRECTORS OF
 CLEANTECH ACQUISITION CORP.

The undersigned hereby appoints Eli Spiro and Richard Fitzgerald as proxies (the “**Proxies**”), and each of them with full power to act without the other, each with the power to appoint a substitute, and hereby authorizes either of them to represent and to vote, as designated on the reverse side, all common stock of CleanTech Acquisition Corp. (“**CLAQ**”) held of record by the undersigned on [●], 2022, at the Special Meeting of Stockholders (“**Special Meeting of Stockholders**”) to be held at [●] a.m. Eastern Time on [●], 2022, or any postponement or adjournment thereof. Due to the public health concerns relating to the COVID-19 pandemic, after careful consideration, CLAQ has determined that the Special Meeting of Stockholders will be a virtual meeting conducted exclusively via live webcast to facilitate stockholder attendance and participation while safeguarding the health and safety of CLAQ’s stockholders, board of directors and management. To register and receive access to the virtual meeting, stockholders of record and beneficial owners (those holding shares through a bank, broker or other nominee) will need to follow the instructions applicable to them provided in the proxy statement. Such stock shall be voted as indicated with respect to the proposals listed on the reverse side hereof and in the Proxies’ discretion on such other matters as may properly come before the Special Meeting of Stockholders, or any postponement or adjournment thereof.

The undersigned acknowledges receipt of the accompanying proxy statement and revokes all prior proxies for the Special Meeting of Stockholders.

THE SHARES OF COMMON STOCK REPRESENTED BY THIS PROXY WHEN PROPERLY EXECUTED WILL BE VOTED IN THE MANNER DIRECTED HEREIN BY THE UNDERSIGNED STOCKHOLDER. IF NO SPECIFIC DIRECTION IS GIVEN AS TO THE PROPOSALS ON THE REVERSE SIDE, THIS PROXY WILL BE VOTED “FOR” EACH OF THE PROPOSALS PRESENTED TO THE STOCKHOLDERS. PLEASE MARK, SIGN, DATE AND RETURN THE PROXY CARD PROMPTLY.

PLEASE DETACH ALONG PERFORATED LINE AND MAIL IN THE ENVELOPE PROVIDED.

THIS PROXY REVOKES ALL PRIOR PROXIES GIVEN BY THE UNDERSIGNED.

(Continued and to be marked, dated and signed on reverse side)

[White Card]

PROXY

THIS PROXY WILL BE VOTED AS DIRECTED. IF NO DIRECTIONS ARE GIVEN, THIS PROXY WILL BE VOTED “FOR” PROPOSALS 1 THROUGH 9 BELOW. THE CLAQ’S BOARD OF DIRECTORS RECOMMENDS A VOTE “FOR” EACH PROPOSAL.

- (1) **Proposal No. 1 — Business Combination Proposal** — to consider and vote upon a proposal to approve the transactions contemplated under the Merger Agreement, dated as of December 16, 2021, as amended on January 30 and June 6, 2022 (the “**Merger Agreement**”), by and among CleanTech, CleanTech Merger Sub, Inc., a Texas corporation and wholly-owned subsidiary of CleanTech (“**Merger Sub**”) and Nauticus Robotics, Inc., a Texas corporation (“**Nauticus**” or “**Nauticus Robotics**”), (the “**Business Combination**”), a copy of which is attached to the proxy statement/prospectus as Annex A. The Business Combination Proposal is conditioned on the approval of each of the, the Charter Approval Proposal, the Bylaws Proposal, the Directors Proposal, the Stock Plan Proposal, the Nasdaq Merger Proposal and the Nasdaq PIPE Proposal. Therefore, if any of the aforementioned proposals is not approved, the Business Combination Proposal will have no effect, even if approved by holders of CLAQ’s common stock.

FOR AGAINST ABSTAIN

- (2) **Proposal No. 2 — Charter Approval Proposal** — to consider and vote upon a proposal to approve the Second Amended and Restated Certificate of Incorporation of CleanTech, a copy of which is attached to the proxy statement/prospectus as Annex B (the “**Amended Charter**”) to, among other things, change CleanTech’s name to “Nauticus Robotics, Inc.,” to be effective upon the consummation of the Business Combination. The Charter Approval Proposal is dependent on the approval of the Business Combination Proposal. Therefore, if the Business Combination Proposal is not approved, the Charter Approval Proposal will have no effect, even if approved by holders of CLAQ’s common stock.

FOR AGAINST ABSTAIN

- (3) **Proposal No. 3 — Bylaws Proposal** — to consider and vote upon a proposal to approve the Amended and Restated Bylaws of CleanTech, a copy of which is attached to the proxy statement/prospectus as Annex C (the “**Amended Bylaws**”) to, among other things, to be effective upon the consummation of the Business Combination. The Bylaws Proposal is dependent on the approval of the Business Combination Proposal. Therefore, if the Business Combination Proposal is not approved, the Bylaws Proposal will have no effect, even if approved by holders of CLAQ’s common stock.

FOR AGAINST ABSTAIN

- (4) **Proposal No. 4 — Governance Proposals** — to approve and adopt, on a non-binding advisory basis, certain differences, in the governance provisions set forth in the Amended Charter, as compared to the company’s current charter, which are being presented in accordance with the requirements of the U.S. Securities and Exchange Commission (the “**SEC**”) as five (5) separate sub-proposals. The Governance Proposals are dependent on the approval of the Business Combination Proposal. Therefore, if the Business Combination Proposal is not approved, the Governance Proposals will have no effect, even if approved by holders of CLAQ’s common stock.

Proposal 4A — Change in Authorized Shares — to increase the authorized number of shares to [●] shares, consisting of [●] shares of common stock and [●] shares of preferred stock.

FOR AGAINST ABSTAIN

Proposal 4B — Classified Board — to divide the board into three classes with only one class of directors being elected each year and each class (except for those directors appointed prior to the first annual meeting of stockholders) serving a three-year term.

FOR AGAINST ABSTAIN

Proposal 4C — Removal of Directors — to include a provision the board or any director of the board may be removed from office at any time, but only for cause and only by the affirmative vote of the holders of at least two-thirds (66 and 2/3%) of the voting power of all of the then outstanding shares of voting stock of the company entitled to vote at an election of directors.

FOR AGAINST ABSTAIN

Proposal 4D — Required Stockholder Vote to Amend Certain Sections of the Amended Charter — to provide that in addition to any vote required by applicable law, the approval by affirmative vote of the holders of at least two-thirds (66 and 2/3%) in voting power of the then outstanding shares of the company generally entitled to vote thereon, voting together as a single class, is required to make any amendment to Part B of Article IV, Article V, Article VI, Article VII, Article VIII, and this Article IX of the Amended Charter.

FOR AGAINST ABSTAIN

Proposal 4E — Required Stockholder Vote to Amend the Amended and Restated Bylaws — to provide that the Amended and Restated Bylaws may be amended by either (i) the directors of the board, who are expressly authorized to adopt, amend, or repeal the Amended and Restated Bylaws, or (ii) the stockholders of the company, who may vote for the adoption, amendment or repeal of the Amended and Restated Bylaws of the company with the affirmative vote of the holders of at least two-thirds (66 and 2/3%) of the voting power of all of the then outstanding shares of voting stock of the company entitled to vote generally in an election of directors.

FOR AGAINST ABSTAIN

- (5) **Proposal No. 5 — Directors Proposal** — to consider and vote upon a proposal to elect, effective as of the consummation of the Business Combination, the persons named below be elected to serve on the board until their respective successors are duly elected and qualified. The Directors Proposal is dependent on the approval of the Business Combination Proposal. Therefore, if the Business Combination Proposal is not approved, the Directors Proposal will have no effect, even if approved by holders of CLAQ's common stock.

FOR WITHHOLD

<u>Name of Director</u>	<u>Class of Directorship</u>
Nicolaus Radford	Class III
Eli Spiro	Class II
Mark Mey	Class III
Lisa Porter	Class II
Jim Bellingham	Class I
Adam Sharkawy	Class I
Joseph W. Dyer	Class II
John W. Gibson, Jr.	Class II

- (6) **Proposal No. 6 — Stock Plan Proposal** — to consider and vote upon a proposal to approve the Nauticus Robotics, Inc. 2022 Incentive Award Plan (the "Incentive Award Plan"), a copy of which is to be attached to the proxy statement/prospectus as Annex D, to be effective upon the consummation of the Business Combination. The Stock Plan Proposal is dependent on the approval of the Business Combination Proposal. Therefore, if the Business Combination Proposal is not approved, the Stock Plan Proposal will have no effect, even if approved by holders of CLAQ's common stock.

FOR AGAINST ABSTAIN

- (7) **Proposal 7 — Nasdaq Merger Proposal** — to consider and vote upon a proposal to approve for purposes of complying with Nasdaq Listing Rule 5635(a) and (b), the issuance of more than 20% of the issued and outstanding shares of common stock and the resulting change in control in connection with the Business Combination. The Nasdaq Merger Proposal is dependent on the approval of the Business Combination Proposal. Therefore, if the Business Combination Proposal is not approved, the Nasdaq Merger Proposal will have no effect, even if approved by holders of CLAQ's common stock.

FOR AGAINST ABSTAIN

-
- (8) **Proposal 8 — Nasdaq PIPE Proposal** — to consider and vote upon a proposal to approve for purposes of complying with Nasdaq Listing Rule 5635(d), the issuance or potential issuance of more than 20% of the common stock in connection with the PIPE Investment in connection with the Business Combination. The Nasdaq PIPE Proposal is dependent on the approval of the Business Combination Proposal. Therefore, if the Business Combination Proposal is not approved, the Nasdaq PIPE Proposal will have no effect, even if approved by holders of CLAQ's common stock.

FOR AGAINST ABSTAIN

- (9) **Proposal 9 — Adjournment Proposal** — to consider and vote upon a proposal to approve the adjournment of the Meeting by the chairman thereof to a later date, if necessary, under certain circumstances, including for the purpose of soliciting additional proxies in favor of the foregoing Proposals, in the event the company does not receive the requisite stockholder vote to approve the proposals. The Adjournment Proposal is not conditioned on the approval of any other proposal.

FOR AGAINST ABSTAIN

IN THEIR DISCRETION THE PROXIES ARE AUTHORIZED AND EMPOWERED TO VOTE UPON OTHER MATTERS THAT MAY PROPERLY COME BEFORE THE MEETING OF STOCKHOLDERS AND ALL CONTINUATIONS, ADJOURNMENTS OR POSTPONEMENTS THEREOF.

To change the address on your account, please check the box and indicate your new address in the address space provided below

STOCKHOLDER'S SIGNATURE

Signature of Shareholder
Address

Date

Signature of Shareholder
Address

Date

Note: Please sign exactly as your name or names appear on this proxy. When common stock is held jointly, each holder should sign. When signing as an executor, administrator, attorney, trustee or guardian, please give full title as such. If the signer is a corporation, please sign in full corporate name by duly authorized officer, giving full title as such. If the signer is a partnership, please sign in partnership name by authorized person.

IMPORTANT: PLEASE MARK, SIGN, DATE AND MAIL THIS PROXY CARD PROMPTLY!
